



YEARS: 2017-PRESENT

MAKE: CHRYSLER

MODEL: PACIFICA

STYLE: VAN

WARNING: NEVER EXCEED YOUR VEHICLE MANUFACTURER'S RECOMMENDED TOWING CAPACITY

WEIGHT CARRYING:
 TRAILER WEIGHT: 3,500 LBS.
 TONGUE WEIGHT: 350 LBS.

WARNING:
 ALL NON-TRAILER (WHEEL-LESS) LOADS APPLIED TO THIS PRODUCT MUST BE SUPPORTED BY 18050 STABILIZING STRAPS.

PRO INSTALL TIME: 45 MIN.
NOVICE INSTALL TIME: 90 MIN.

IF YOU ARE HESITANT TO UNDERTAKE THIS TASK ON YOUR OWN, CONTACT AN AUTHORIZED CURT INSTALLER FOR ADDITIONAL ASSISTANCE.

INSTALLATION TIPS:

- BEFORE YOU BEGIN INSTALLATION, READ ALL INSTRUCTIONS THOROUGHLY.
- TO EASE INSTALLATION, 2 PEOPLE MAY BE REQUIRED.
- USING PROPER TOOLS WILL GREATLY IMPROVE THE QUALITY OF THE INSTALL AND REDUCE THE TIME REQUIRED.



INSTALLATION REQUIRES:

RATCHET	TORQUE WRENCH	6" SOCKET EXTENSION
8mm 10mm 3/4" SOCKET	UNIVERSAL JOINT SOCKET	SCREW DRIVER
MASKING TAPE	AVIATION SHEARS	DIE GRINDER
SAFETY GLASSES		

LEVEL OF DIFFICULTY: MODERATE

EASY	MODERATE	CHALLENGING
	LOWER EXHAUST	
	TEMPORARILY REMOVE HEAT SHIELD(S)	
	TRIMMING REQUIRED	
	FISHWIRE (4) BOLTS	
	REVERSE FISHWIRE (2) BOLTS	

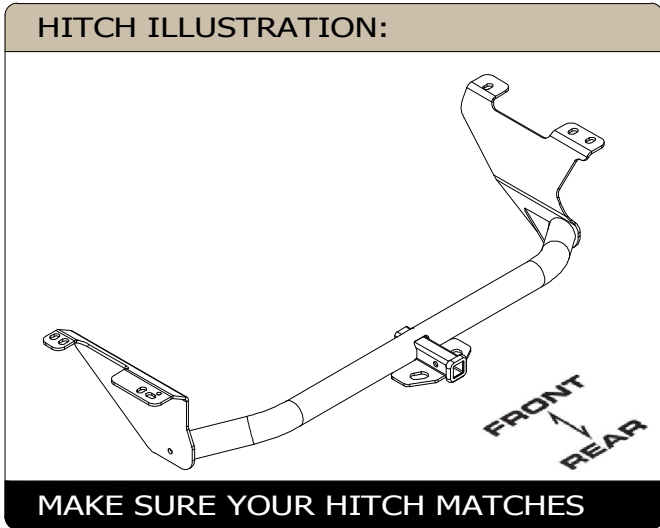

PERIODICALLY CHECK THIS RECEIVER HITCH TO ENSURE ALL FASTENERS ARE TIGHT AND ALL STRUCTURAL COMPONENTS ARE SOUND
 CURT Manufacturing LLC. warrants this product to be free of defects in material and/or workmanship at the time of retail purchase by the original purchaser. If the product is found to be defective, CURT Manufacturing LLC. may repair or replace the product at their option, when the product is returned, prepaid, with proof of purchase. Alteration to, misuse of, or improper installation of this product voids the warranty. CURT Manufacturing LLC.'s liability is limited to repair or replacement of products found to be defective, and specifically excludes liability for incidental or consequential loss or damage.

INSTALLATION WALKTHROUGH:

Parts List			
ITEM	QTY	PART NUMBER	DESCRIPTION
1	5	1/2-13 x 1 1/2	CARRIAGE BOLT
2	5	CM-SP10	.250 x 1.00 x 2.50" SQUARE HOLE SPACER
3	5	1/2 CONICAL TOOTHED WASHER	WASHER, CONICAL, TOOTHED, 1/2"
4	5	HFN 1213	HEX FLANGE NUT
5	5	1_2 FISHWIRE	1/2" FISHWIRE
6	1	M6 - 1.00 X 40 TAP BOLT	TAP BOLT
7	1	1_4-20 x 1.00 HEX BOLT	1/4-20 x 1.00 HEX BOLT
8	1	1_4 - 20	HEX NUT

FISHWIRE TECHNIQUE

INSERT COILED END OF FISHWIRE TOOL THROUGH HITCH MOUNTING HOLE IN VEHICLE FRAME RAIL AND OUT THE ACCESS HOLE. PASS COILED END OF FISHWIRE THROUGH SPACER AND THREAD BOLT INTO COIL. KINK WIRE TO KEEP SPACER SEPARATE FROM BOLT AS SHOWN. PULL FISHWIRE, SPACER, AND BOLT THROUGH FRAME AND OUT MOUNTING HOLE. USE FISHWIRE TO GUIDE HITCH DURING MOUNTING AND PREVENT LOSS OF BOLT / SPACER INSIDE FRAME RAIL.

NOTE: SOME VEHICLES MAY FISHWIRE THROUGH END OF FRAME

REVERSE PULL FISHWIRE TECHNIQUE

ATTACH FISHWIRE TO CARRIAGE BOLT AND SLIDE SPACER ONTO FISHWIRE. PUSH THE BOLT THRU THE HOLE FOLLOWED BY THE SPACER (AS SHOWN). PULL BOLT BACK INTO POSITION, PROTRUDING FROM THE FRAME.

DESIGNED FOR USE WITH BALLMOUNT #45521

RUBBER ISOLATOR REMOVAL DIAGRAM

This technique can be used if an Exhaust Hanger Removal Piece is not available.

Using a 68" open end wrench, slide the wrench up to the rubber isolator, cradling the hanger rod as shown. Next place the flat edge of a pry bar between the wrench and the hanger stop or hanger rod. Then simply rotate the pry bar toward the wrench to remove the rubber isolator.

Note: Using a spray lubricant or soapy water on the hanger rod and the rubber isolator helps removal.

HOLE ENLARGEMENT DIAGRAM

Ø1"

FRONT

↑

REAR

↓

1. Locate and remove (5) screws with 8mm socket, (7) nuts with a 10mm socket, (2) bolts with a 10mm socket, and (2) plastic screws with a screwdriver.

NOTE: if no underbody panel, skip to Step 3.

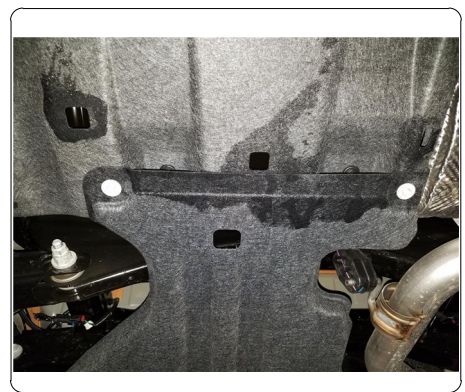

2. Locate and remove (3) screws from driver side wheel well with an 8mm socket. Remove underbody panel and mark out a 0.5" x 10" slot with masking tape. Use aviation shears to trim underbody panel. Set aside for later reinstallation.

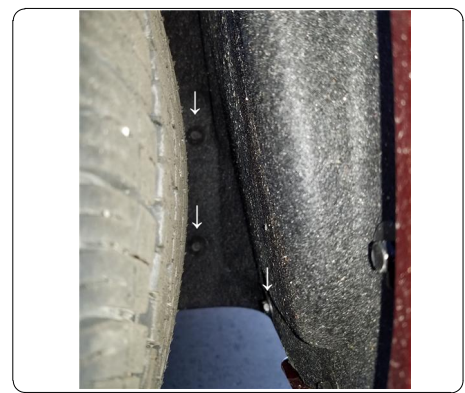

INSTALLATION WALKTHROUGH:

3. Lower exhaust by removing (2) rubber isolators.
(See Rubber Isolator Removal Diagram on previous page)



4. Locate and remove (2) plastic nuts with a 10mm socket. Remove heat shield and mark out a 5" x 13" section with masking tape. Use aviation shears to trim marked area. Reinstall with (1) nut using a 10mm socket.
NOTE: If no underbody panel, remove (4) plastic nuts, trim panel, and reinstall with (3) plastic nuts.

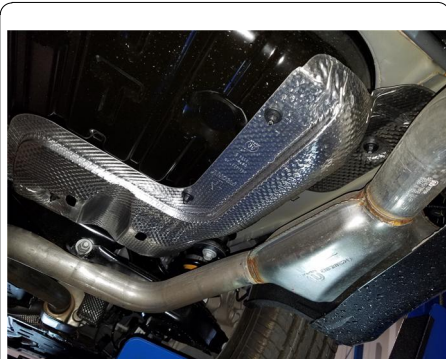

5. **On Hybrid models only:** temporarily remove emissions canister on driver side frame rail using 10mm socket to remove (2) bolts. Use provided M6 hardware to reinstall.



6. **On Hybrid models only:** enlarge holes on driver side frame rail using die grinder as shown in the Hole Enlargement Diagram



INSTALLATION WALKTHROUGH:

7. Fishwire (1) 1/2" carriage bolt and (1) CM-SP10 spacer in the rear most holes of driver side frame rail through the access hole. Fishwire (2) 1/2" carriage bolts and (2) CM-SP10 spacers in the rear most holes of passenger side frame rail through the access hole. Reverse Fishwire (1) 1/2" carriage bolt and (1) CM-SP10 spacer into the access hole on each frame rail.



8. On driver side frame rail locate and remove (1) nut using 10mm socket.
NOTE: If electrical ground is present relocate using provided 1/4" hardware. Assure the area is free of rust, dirt and paint.



9. Raise hitch into position starting with the passenger side. Run the fishwires through the holes on hitch to help align bolts with hitch holes. Remove fishwires and loosely fasten (2) 1/2" hex flange nuts on driver side and (3) 1/2" hex flange nuts on passenger side.

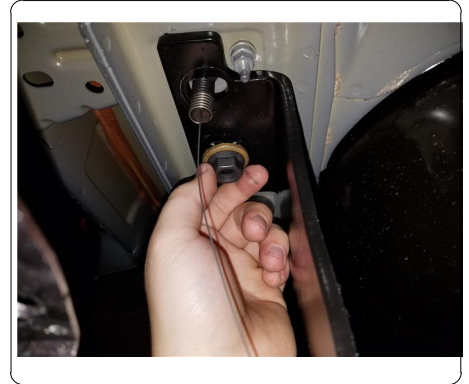
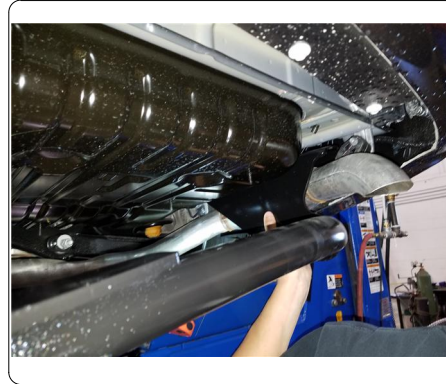

10. Torque all 1/2" hardware to 110 ft-lbs. Reinstall Underbody panel following steps 1 and 2 in reverse order.



TOWING SAFETY INFORMATION

Gross Trailer Weight / GTW

The Gross Trailer Weight is the weight of the trailer & cargo. Measure this by putting the fully loaded trailer on a vehicle scale.



Tongue Weight / TW

The downward force that is exerted on the hitch ball by the coupler. The tongue weight will vary depending on where the load is positioned in relationship to the trailer axle(s). To measure the tongue weight, use either a commercial scale or a bathroom scale with the coupler at towing height. When using a bathroom scale with heavier tongue weights, use the method shown and multiply the scale reading by 3.

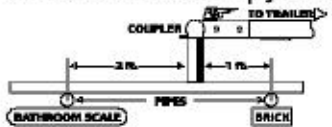

Weight Carrying / WC

The total weight of both the trailer and the cargo inside. Never exceed the weight capacity of your trailer hitch.

Weight Distribution / WD

Used to balance the weight of the cargo between the front and rear wheels throughout the trailer, allowing for better steering, braking, and level riding.



Sway Control

A device used to reduce the lateral movements of the trailer that are caused by the wind. This works in conjunction with a weight distribution hitch. Do not use this on a class 1 or 2 hitch, or with surge brakes.

How Much Can You Safely Tow?

TONGUE WEIGHT (lb.)	1500	2000	3000	4000	5000	6000	7000	8000	10,000	12,000	
CLASS 1	CLASS 1										
CLASS 2	CLASS 2										
CLASS 3	CLASS 3										
CLASS 4	CLASS 4										
CLASS 5	CLASS 5										
Coupler	11	12	13	14	15	16					
Inc.	1100	1200	1300	1400	1500	1600					
Weight	17	18	19	20	22	24	26	28	30	32	
Inc.	2100	2400	2700	3000	3300	3600	3900	4200	4500	4800	
Weight	14	15	16	17	18	19	20	21	22	23	
Inc.	2800	3200	3600	4000	4400	4800	5200	5600	6000	6400	
5th Wheel											

Refer to owner's manual for towing capabilities and limitations.

Ball Mount

The ball mount is placed inside the opening of the receiver hitch which is mounted to the vehicle. Make sure a hitch pin and clip is properly securing the ball mount to the receiver hitch before you begin towing.

- A: Rise. B: Drop. C: Hole Size. D: Length.

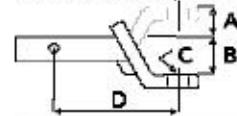

Trailer Ball

The connection from the hitch to the trailer. There are many factors that determine the correct hitch ball:

- Number one is the hitch ball's gross trailer weight rating.
- The mounting platform must be at least 3/8" thick.
- The hole diameter must not be more than 1/16" larger than the threaded shank.
- Every time you tow, check the nut and lock washer to make sure they are fastened securely.
- A: Ball Dia. B: Shank Length. C: Shank Dia. D: Shank Rise.

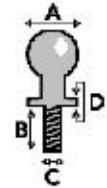

Coupler

The component that is placed over the trailer ball to connect the vehicle to the trailer. Be sure that the coupler size matches the size of the hitch ball and that the coupler handle is securely fastened. To determine what size hitch ball you need for your application you will need to know the size of coupler that is on the trailer. Be sure your coupler is properly adjusted to the ball you are using.

NOTE: For added security the use of safety devices such as Coupler Safety Pins and Locks is strongly recommended.

Safety Chains

Safety chains are a requirement and should be crossed under the tongue of the trailer so that the tongue will not drop to the road if it becomes separated from the hitch. Always leave enough slack so you can turn. Never allow the safety chains to drag on the ground and never attach the chains to the bumper.

Trailer Classification: Safety Chain Breaking Force - Minimum

Class 1: 2,000 lbs. (8.9 kN)

Class 2: 3,500 lbs. (15.6 kN)

Class 3: 5,000 lbs. (22.2 kN)

The strength rating of each length of safety chain or its equivalent and its attachments shall be equal to or exceed in minimum breaking force the GVWR (Gross Vehicle Weight Rating) of the trailer.

Electrical

Trailer lights, Electric Brakes, Break-away systems - Every time you tow, be sure to check that all components are working properly.

Wiring identification by color:



CURT DISCLAIMER: WIRING COLOR SHOWN WORK IN CONJUNCTION WITH CURT MANUFACTURING PRODUCTS.

12180

CHRYSLER PACIFICA

GROSS LOAD CAPACITY WHEN USED AS A WEIGHT CARRYING HITCH: 3,500 LBS. TRAILER WEIGHT & 350 LBS. TONGUE WEIGHT.
 WARNING: ALL NON-TRAILER (WHEEL-LESS) LOADS APPLIED TO THIS PRODUCT MUST BE SUPPORTED BY 18050 STABILIZING STRAPS.



WARNING: ** FAILURE TO PROPERLY SUPPORT NON-TRAILER LOADS WILL VOID PRODUCT WARRANTY **

WARNING: * DO NOT EXCEED VEHICLE MANUFACTURER'S RECOMMENDED TOWING CAPACITY *****



Parts List			
ITEM	QTY	PART NUMBER	DESCRIPTION
1	5	1/2-13 x 1 1/2	CARRIAGE BOLT
2	5	CM-SP10	.250 x 1.00 x 2.50" SQUARE HOLE SPACER
3	5	1/2 CONICAL TOOTHED WASHER	WASHER, CONICAL, TOOTHED, 1/2"
4	5	HFN 1213	HEX FLANGE NUT
5	5	1_2 FISHWIRE	1/2" FISHWIRE
6	1	M6 - 1.00 X 40 TAP BOLT	TAP BOLT
7	1	1_4-20 x 1.00 HEX BOLT	1/4-20 x 1.00 HEX BOLT
8	1	1_4 - 20	HEX NUT

TOOLS REQUIRED
RATCHET
TORQUE WRENCH
6" SOCKET EXTENSION
8mm, 10mm, 3/4" SOCKETS
UNIVERSAL JOINT SOCKET
SCREWDRIVER
MASKING TAPE
AVIATION SHEARS
DIE GRINDER
SAFETY GLASSES

REVERSE PULL FISHWIRE TECHNIQUE

ATTACH FISHWIRE TO CARRIAGE BOLT AND SLIDE SPACER ONTO FISHWIRE. PUSH THE BOLT THRU THE HOLE FOLLOWED BY THE SPACER (AS SHOWN). PULL BOLT BACK INTO POSITION, PROTRUDING FROM THE FRAME.

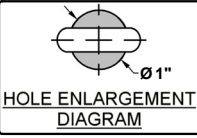
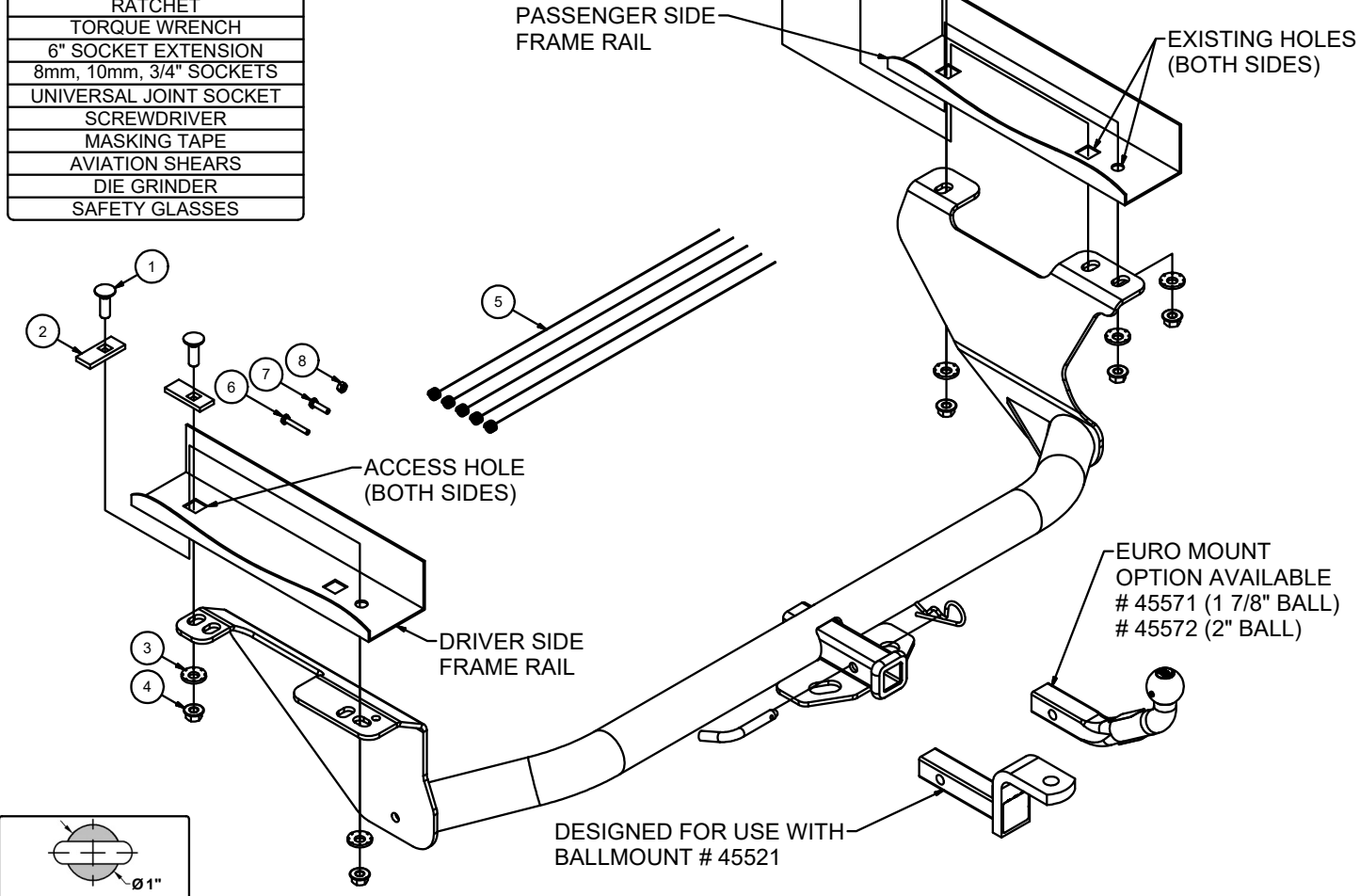

HITCH WEIGHT: 39 LBS.
 INSTALL TIME
 PROFESSIONAL: 45 MINUTES
 NOVICE (DIY): 90 MINUTES
 INSTALL NOTES:
 -LOWER EXHAUST
 -REMOVE HEAT SHIELD(S)
 -TRIM HEAT SHIELD
 -TRIM UNDERBODY PANEL

FISHWIRE TECHNIQUE

INSERT COILED END OF FISHWIRE TOOL THROUGH HITCH MOUNTING HOLE IN VEHICLE FRAME RAIL AND OUT THE ACCESS HOLE. PASS COILED END OF FISHWIRE THROUGH SPACER AND THREAD BOLT INTO COIL. KINK WIRE TO KEEP SPACER SEPERATE FROM BOLT AS SHOWN. PULL FISHWIRE, SPACER, AND BOLT THROUGH FRAME AND OUT MOUNTING HOLE. USE FISHWIRE TO GUIDE HITCH DURING MOUNTING AND PREVENT LOSS OF BOLT / SPACER INSIDE FRAME RAIL.
 NOTE: SOME VEHICLES MAY FISHWIRE THROUGH END OF FRAME



PERIODICALLY CHECK THIS RECEIVER HITCH TO ENSURE THAT ALL FASTENERS ARE TIGHT AND THAT ALL STRUCTURAL COMPONENTS ARE SOUND.

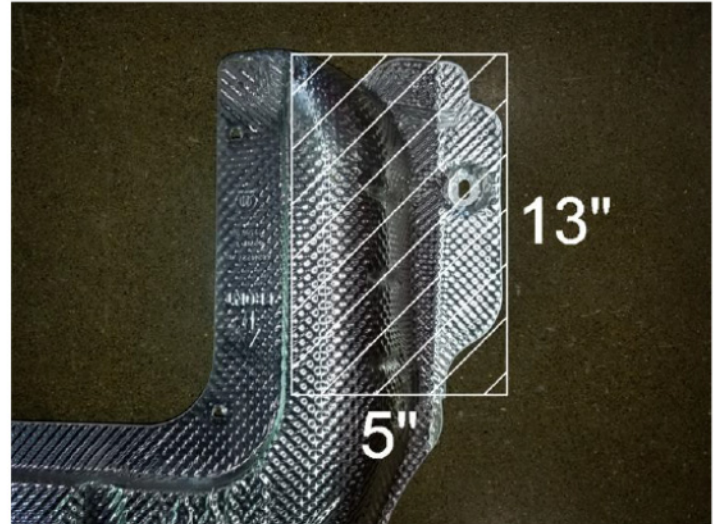
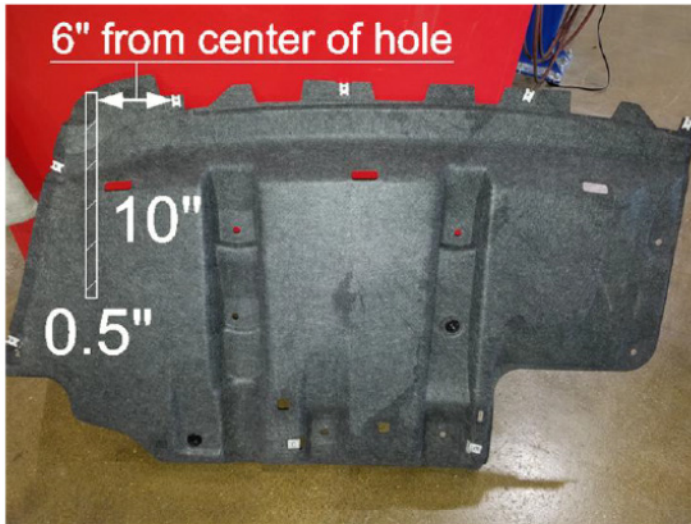

INSTALLATION STEPS

1. Locate and remove (5) screws with 8mm socket, (7) nuts with a 10mm socket, (2) bolts with a 10mm socket, and (2) plastic screws with a screwdriver. **NOTE:** If no underbody panel, skip to Step 3.
2. Locate and remove (3) screws from driver side wheel well with a 8mm socket. Remove underbody panel and mark out a 0.5" x 10" slot with masking tape. Use aviation shears to trim underbody panel. Set aside for later reinstallation.
3. Lower exhaust by removing (2) rubber isolators. (See Rubber Removal Isolator Diagram on previous page)
4. Locate and remove (2) plastic nuts with a 10mm socket. Remove heat shield and mark out a 5" x 13" section with masking tape. Use aviation shears to trim marked area. Reinstall with (1) nut using a 10mm socket. **NOTE:** if no underbody panel, instead remove (4) plastic nuts, trim panel, and reinstall with (3) plastic nuts.
5. **On Hybrid models only:** temporarily remove emissions cannister on driver side frame rail using 10mm socket.
6. **On Hybrid models only:** Enlarge holes on driver side frame rail using die grinder as shown in the Hole Enlargement Diagram
7. Fishwire (1) 1/2" carriage bolt and (1) CM-SP10 spacer in the rear most hole of the frame rail through the access hole on driver side frame rail. Fishwire (3) 1/2" carriage bolts and (2) CM-SP10 spacers in the rear most hole of the frame rail through the access hole on passenger side frame rail. Reverse Fishwire (1) 1/2" carriage bolt and (1) CM-SP10 spacer into the access hole on each frame rail.
8. On driver side frame rail locate and remove (1) nut using 10mm socket. **NOTE:** If electrical ground is present relocate using provided 1/4" hardware. Assure the area is free of rust, dirt and paint.
9. Raise hitch into position starting with the passenger side. Run the fishwires through the holes on hitch to help align bolts with hitch holes. Remove fishwires and loosely fasten (2) 1/2" hex flange nuts on driver side and (2) 1/2" hex flange nuts on driver side
10. Torque all 1/2" hardware to 110 ft-lbs. Reinstall underbody panel following Steps 1 and 2 in reverse order.

PERIODICALLY CHECK THIS RECEIVER HITCH TO ENSURE THAT ALL FASTENERS ARE TIGHT AND THAT ALL STRUCTURAL COMPONENTS ARE SOUND.