

INSTALLATION MANUAL

11596

Level of Difficulty

Moderate

Installation difficulty levels are based on time and effort involved and may vary depending on the installer level of expertise, condition of the vehicle and proper tools and equipment.

Weight Carrying Capacity

Gross trailer weight (GTW)	2,000 lbs.
Tongue weight (TW)	200 lbs.

Parts List

Item	Qty	Description
1	4	Carriage bolt, 7/16"-14 x 1-1/2", grade 5
2	4	Square-hole spacer, 1/4" x 1" x 1-1/2"
3	4	Flange nut, 7/16"-14
4	4	Fishwire, 7/16"

Tools Required

Ratchet	Flathead screwdriver
Socket, 13/16"	Drill
Socket, 10mm	Drill bit, 1/2"
Socket extension	Die grinder
Torque wrench	Paint marker
Utility knife	Tape measure
Safety glasses	--

⚠ WARNING

Never exceed the vehicle manufacturer's recommended towing capacity.

Product Photo



NOTICE

Before you begin installation, read all instructions thoroughly.

Proper tools will improve the quality of installation and reduce the time required.

This installation requires:

- Lowering of the exhaust
- Trimming the underbody panel and heat shield
- Drilling and hole enlargement

Periodic inspection of the trailer hitch should be performed to ensure all mounting hardware remains tight and structural components are secure.

To help prevent damage to the product or vehicle, refer to the specified torque specifications when securing hardware during the installation process.

SAFETY INSTRUCTIONS

Safety glasses should be worn at all times while installing this product.

ASSEMBLY

Parts List

Item	Qty	Description
1	4	Carriage bolt, 7/16"-14 x 1-1/2", grade 5
2	4	Square-hole spacer, 1/4" x 1" x 1-1/2"
3	4	Flange nut, 7/16"-14
4	4	Fishwire, 7/16"

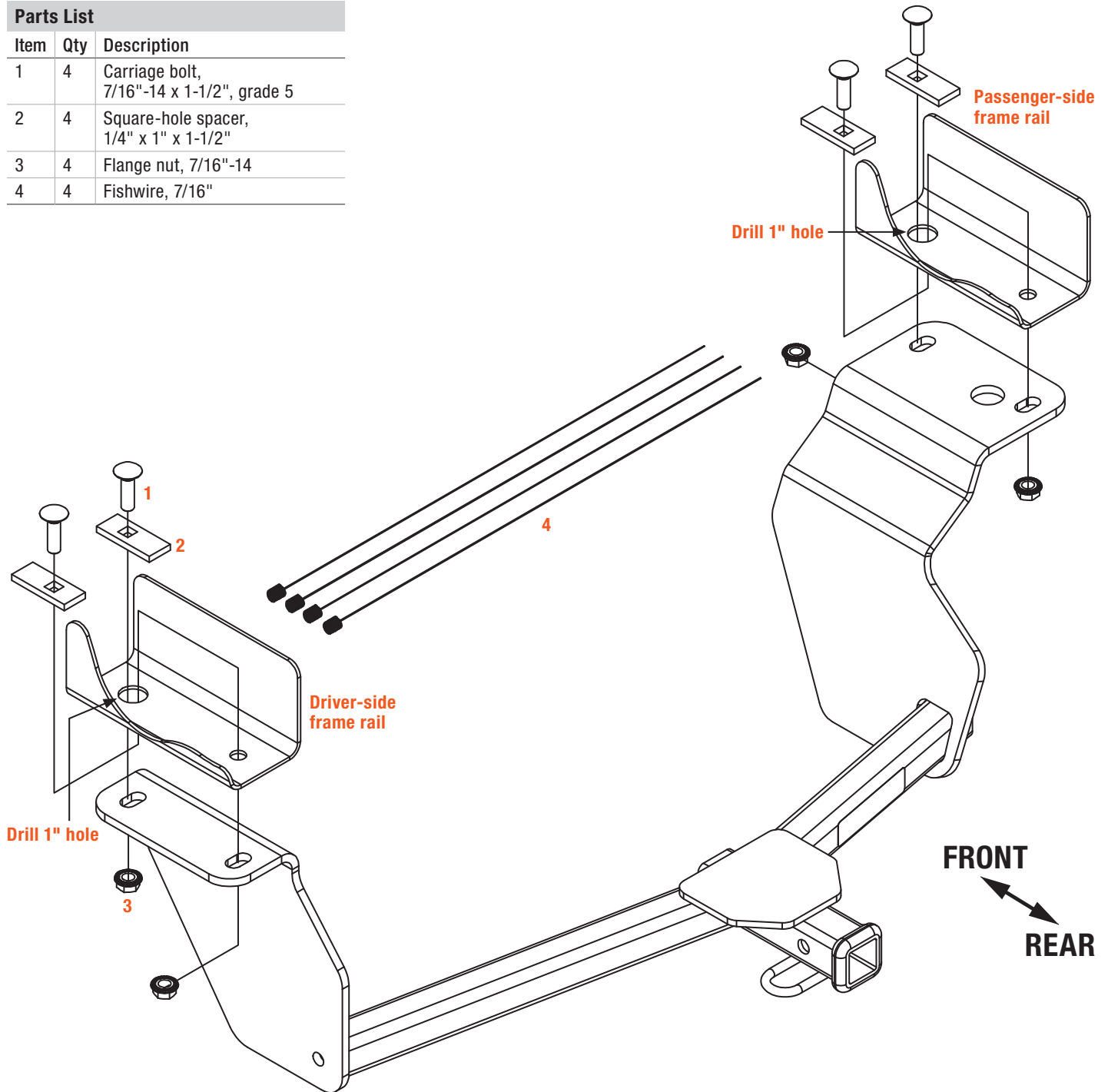

FISHWIRE TECHNIQUE

Insert coiled end of fishwire tool through hitch mounting hole in vehicle frame rail and out the access hole. Pass coiled end of fishwire through spacer and thread bolt into coil. Kink wire to keep spacer separate from bolt as shown. Pull fishwire, spacer and bolt through frame and out mounting hole. Use fishwire to guide hitch during mounting and prevent loss of bolt or spacer inside frame rail.

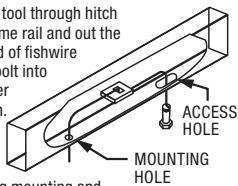

RUBBER ISOLATOR REMOVAL DIAGRAM

This technique can be used if exhaust hanger removal pliers are not available.

Using a 5/8" open end wrench, slide the wrench up to the rubber isolator, cradling the hanger rod as shown.

Place the flat edge of a pry bar between the wrench and the hanger stop or hanger rod. Then simply rotate the pry bar toward the wrench to remove the rubber isolator.

Note: Using a lubricant or soapy water on the hanger rod and the rubber isolator helps removal.

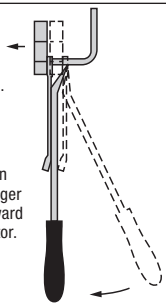

Step 1

Lower the muffler by removing the three rearmost rubber exhaust hangers.

Note: Be sure to support the exhaust to prevent damage during removal.



Step 2

Using a 10mm socket, remove the three nuts securing the heat shield. Remove the heat shield and trim a 3" x 7" slot as shown.

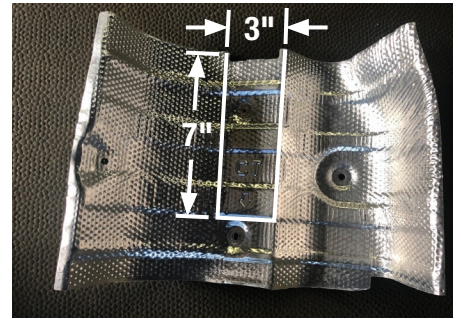
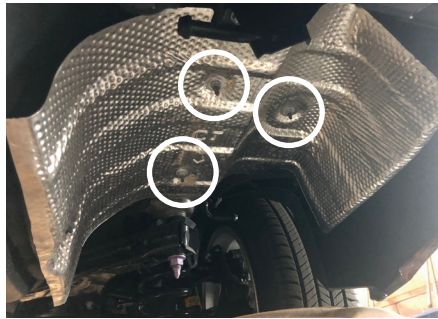

Step 3

Use a flathead screwdriver to remove the push fasteners from the underbody panel. Trim a 2" x 11-1/4" slot on underbody panel as shown.

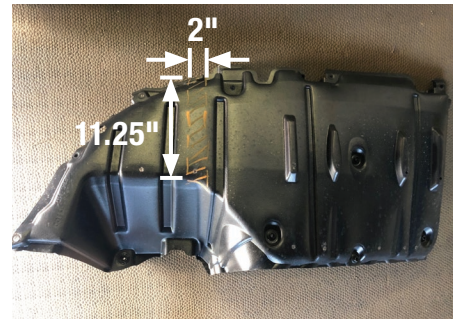

Step 4

Remove the rubber plugs on the driver and passenger side frame rails. Remove any caulk on the driver and passenger side frame rails with a utility knife.



Step 5

Raise the trailer hitch into position, aligning the rearmost hole in the hitch bracket with the rear attachment hole in the frame rail. Mark the drilling locations for drilling the forward attachment hole. Set the trailer hitch aside.

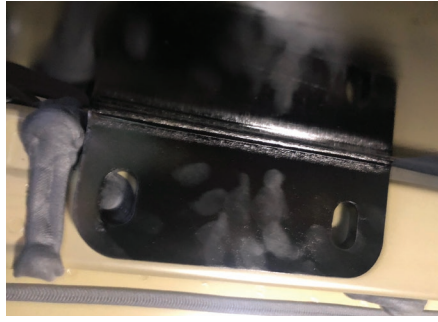

Step 6

On driver-side frame rail, drill a 1/2" hole. Using a die grinder, enlarge the hole to 1".

Repeat on the passenger side.



Step 7

On both sides of the vehicle, fishwire (#4) 7/16" carriage bolt (#1) and square-hole spacer (#2) from drilled 1" hole into the rearmost existing hole; and fishwire (#4) 7/16" carriage bolt (#1) and square-hole spacer (#2) into drilled 1" hole.



FISHWIRE TECHNIQUE

Insert coiled end of fishwire tool through hitch mounting hole in vehicle frame rail and out the access hole. Pass coiled end of fishwire through spacer and thread bolt into coil. Kink wire to keep spacer separate from bolt as shown. Pull fishwire, spacer and bolt through frame and out mounting hole. Use fishwire to guide hitch during mounting and prevent loss of bolt or spacer inside frame rail.

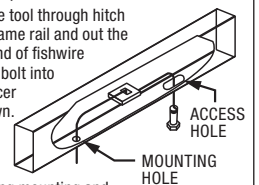

Step 8

Reinstall the trimmed heat shield. Raise the trailer hitch into position over the exhaust and onto the carriage bolts. Remove the fishwire (#4). Loosely install the provided flange nuts (#3). **Note:** Make sure you do not push the fasteners into the frame rail.

Tighten all fasteners with a torque wrench to 42 lb-ft (57 N*m). **Note:** The heat shield is not shown in the picture for clearance purposes.



Step 9

Reinstall the underbody panel and exhaust hangers. Return the exhaust to its original position. **Note:** The underbody panel is not shown in the picture for clearance purpose.

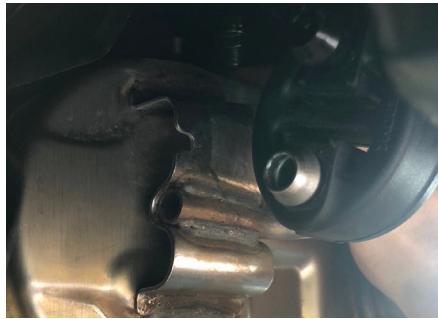

Final Installed Image

