



FA1000 SERIES REFRIGERANT RECOVER / RECYCLE / EVACUATION AND RECHARGE UNIT

Unit covered under US Patent
8,082,750 and other patents
pending.

Certified by ITS under SAE
J2911 to meet SAE J2788 for
R-134a.

Certified by ITS under SAE
J2911 to meet high voltage
compressor service per SAE
2788 for R-134a.



OPERATION MANUAL

Models: FA1000, FA1000A, FA1000B FA1000AB, FA1000E, FA1000J

Unit Consists Of:

- FA1000 Series Mach 7 Automotive Refrigerant Recover / Recycling / and Recharge Machine
- 6 CFM 50 micron vacuum pump
- Recovery Cylinder - FA1000 and FA1000J included a 50 lb DOT storage tank, FA1000B and FA1000AB include 92 lb storage tank
FA1000E does not include storage tanks. User must use country approved storage tanks
- Low and High side service hoses for R-134a
- Low and High side R-134a couplers
- Tank refill adapter, 1/2" ACME RH Female for R-134a
- 41 cubic Inch CPS filter drier (Replacement part number ARXF5)
- Tank filter bracket with hardware and all tank hoses if the tank is not included
- 1 lb (454 gram) check weight
- Operation manual
- Models FA1000/FA1000B come with UView 481500 Oil/Dye Injection Kit, All other models come with integrated Oil Injection System

End user to provide:

- R-134a
- Refrigerant oil and/or dye for injection system

Table of Contents

Specifications.....	2
Introduction.....	3
General Safety Instructions.....	4
Initial Equipment Preparation.....	5
Initial Set-Up.....	6
Operating Instructions.....	7-16
Maintenance.....	17-20
High Voltage Charging, Hose Maintenance and Troubleshooting Chart.....	21
Service Parts and Accessories.....	22-23

	FA1000 Specifications			
Models	FA1000 / FA1000B	FA1000J	FA1000A / FA1000AB	FA1000E
Compressor Type	2/3 HP, 2 cylinder oil-less reciprocating compressor			
Dimensions	22" W x 24.5" D x 42" H			
Weight	100 lbs (does not include tank weight)			
Operating Range	10°C (50°F) to 49°C (120°F)			
Power Source	115 VAC 60Hz 1Ph	100 VAC 50/60Hz 1Ph	220-240 VAC 50Hz 1Ph	220-240 VAC 50Hz 1Ph
Power Consumption	1000 W			
Low Side Gauge	-30 inch Hg to 125 PSIG			
High Side Gauge	0 to 500 PSIG			
Filtration	41 cubic inch drier, .7 micron oil separator			
Automatic Control Valves	Patented motorized ball valves to control HI, LO, recover, and vacuum			
Charging Valve	12 VDC Solenoid Valve			
Construction	1" Heavy duty tubular frame construction 10" pneumatic wheels, 4" swivel casters			
Overload Protection	15A Thermal Breaker	15A Thermal Breaker	10A Thermal Breaker	10A Thermal Breaker
High Pressure Shut-Off	30 bar (450 psig)			
Refrigerants	R-134a			

INTRODUCTION

Thank you for purchasing the **CPS FA1000** series unit. The FA1000 has been designed to meet SAE J2788 and J2911 standards as required by the USEPA. In accomplishing this goal, CPS has integrated its latest patent pending technology and incorporated state of the art features while improving reliability and performance. The unit also meets the SAE standards for High Voltage Compressor service.

The FA1000 automatically recovers, recycles, evacuates, and recharges mobile A/C systems. Simply hook up the service hoses, choose the desired operation, and allow the unit to automatically complete the A/C service.

The FA1000 utilizes a single pass (oil coalescing, particle filtration, and moisture removal) recycling system, which means that whenever the FA1000 recovers, it also recycles. The unit also incorporates automatic air purge to remove unwanted non-condensable gasses from the refrigerant. Thus the refrigerant storage tank always contains the cleanest refrigerant possible for future recharge use.

The FA1000 utilizes CPS's patented motorized ball valves. The motorized ball valves are unique to the industry in that they will not be affected by sealants, particulates, and other contaminants. The motorized ball valves incorporate passage ways 8-15 times larger than the existing solenoid valves orifice technology. In fact the FA1000 uses no solenoid or check valves in the active flow path during recovery or evacuation, thus enhancing speed.

The FA1000 utilizes CPS's patent pending two cylinder oil-less compressor. This compressor improves reliability and performance. Being oil free, no compressor oil maintenance or oil return system is required.

The following are additional features:

- Integrated manifold gauge set. Visually see how the mobile A/C system is operating. No manual valves to open or close
- Large Graphic LCD to view operating instructions. Languages include English, Spanish, French, German, Chinese and more
- A highly accurate electronic charge scale
- Microprocessor Integrated mass flow system keeps track of how much refrigerant has run through the filter drier giving the user maximum amount of run time on each filter (150 LBS per filter)
- Cartridge type 41 inch cubic filter drier. Mounted directly on the storage cylinder for optimal moisture removal and weight accuracy
- Automatic high-pressure shut-off with microprocessor indication
- Interchangeable CPS Recovery cylinders. Use your country's approved refrigerant cylinders. The software allows the user to set up the proper tank and refrigerant parameters. Larger cylinders, such as CPS CRX390T, can be used for larger truck and bus A/C systems
- Modular design for easy replacement of a defective plumbing, scale, electronic, compressor or vacuum pump sub system
- Heavy-duty construction: Powder coated steel cabinet mounted onto a 1" tubular steel frame
- 10" pneumatic rear wheels and 4" swivel casters give this unit excellent maneuverability under the worst of conditions
- Recovers and Evacuates through both the high and low side service hoses
- Separate Vacuum pump for faster evacuations
- Additional service hose lengths available, 8 foot comes standard
- Programmed electrical outlet for optional heater blanket installation
- Oil injection on either or both the High and Low side
- Refrigerant charging on either or both High and Low side
- Approved for High Voltage (Hybrid) AC systems. Equipped with Hybrid hose flush block to clear service hoses of residual oil

To help you get a good start, please continue to carefully read the balance of this manual. This manual contains important information on the proper procedures for operating this equipment. Please pay close attention to the safety information, Warnings, and Cautions provided throughout this manual. Always remember "Safety First".

Certified by Intertek under SAE J2911 to meet SAE J2788 standard for R-134a and the SAE J2788 High Voltage Compressor service provision.

GENERAL SAFETY INSTRUCTIONS

Only qualified service personnel should operate this unit. Most states, countries, etc... may require the user to be licensed. Please check with your local government agency.

DANGER- this unit's recovery tanks contains liquid refrigerant. Overfilling of a recovery tank may cause a violent explosion resulting in severe injury or even death. Do not disable the overfill safety features. Always make sure the correct tank is on the scale.

DANGER- Only use the recovery tanks provided with this unit. See distributor for replacement tanks.

DANGER- Avoid breathing refrigerant vapors and lubricant vapor or mist. Breathing high concentration levels may cause heart arrhythmia, loss of consciousness, or even cause suffocation.

DANGER- Electrical shock hazard!!!! Always disconnect power source when servicing this equipment.

DANGER- DO NOT USE COMPRESSED AIR TO PRESSURE TEST OR LEAK TEST THE UNIT OR VEHICLE AIR CONDITIONING SYSTEM. Some mixtures of air and R-134a refrigerant are combustible at elevated pressures. These mixtures are potentially dangerous and may result in fire or explosion causing personal injury or property damage.

CAUTION- all hoses may contain liquid refrigerant under pressure. Contact with refrigerant may cause frostbite or other related injuries. Wear proper personal protective equipment such as safety goggles and gloves. When disconnecting any hose, please use extreme caution.

CAUTION- avoid breathing refrigerant vapors and/or lubricant mist. Exposure may irritate eyes, nose, throat, and skin. Please read the manufacturers Material Safety Data Sheet for further safety information on refrigerants and lubricants.

CAUTION- to reduce the risk of fire, avoid the use of extension cords thinner than NO. 16 awg. (1,5mm²). The following table references extension cord wire size vs. maximum length:

WIRE GAUGE	MAXIMUM LENGTH (feet)
16	10
14	25
12	50

CAUTION- do not use this equipment in the vicinity of spilled or open containers of gasoline or other flammable substances. Make certain that all safety devices are functioning properly before operating the equipment.

CAUTION- This equipment should be used in locations with mechanical ventilation that provides as least 4 air changes per hour.

CAUTION- RISK OF INJURY, the equipment should only be operated by certified personnel.

CAUTION- Use only CPS certified hose assemblies on this unit. The hose assemblies are made to proper length, contain shut offs where required and have direct affect on the proper operation of this equipment.

INITIAL EQUIPMENT PREPARATION

Models FA1000, FA1000A and FA1000J

Will come with a 50 lb DOT tank and filter assembly pre-mounted on the rear of the machine. Please follow the instructions for initial equipment preparation:

1. Carefully unpack the unit and its contents from its shipping pallet.
2. Remove the Styrofoam insert from below the tank and cut the shipping band from around the tank.
3. Ensure all hose connections are firmly hand tight as they may have come loose during shipping.

The contents of the accessory box are as follows:

- 1 Power cord
- 2 R-134a refill hoses, 1/4" SAE and 1/2" ACME
- 1 1 lb check weight
- 1 R-134a ID tank label

For the FA1000E the following will be included in the tank accessory box.

- 1 Filter, filter bracket, Velcro and tie straps
- 1 Yellow liquid tank to filter hose

For models FA1000, FA1000A and FA1000J go to page 6.

The following are instructions to mount the filter assembly and filter hose onto a self provided recover tank for models FA1000E. Place the tank on the center of the scale (Make sure the tank is free standing).

1. Install the filter bracket on the recovery tank as shown in Figure - 2a. Secure the filter bracket to the tank collar using the supplied tie straps. Cut off the excess tie strap after fully tightening.
2. Secure the filter to the bracket using the supplied Velcro straps making sure the arrow on the filter is pointing to the left as illustrated in Figure - 2b.
3. Install the refrigerant tank and filter hoses as shown in Figure - 2c. Connect the yellow liquid feed hose/hybrid adapter which comes from the machine to the filter port (a). Connect the yellow tank liquid hose from the tank liquid port (d) to the filter port (b). Connect the blue discharge hose coming from the machine to the vapor port (c) on the tank. Finally connect the ground wire to the tank as shown in Figure - 2c. If there is not a brass fitting on your particular tank, any unpainted surface on the tank itself will do.

FIGURE - 1 Shipping bracket

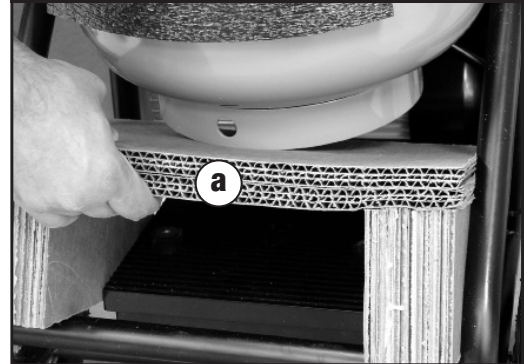

FIGURE - 2a Filter bracket placed on tank collar

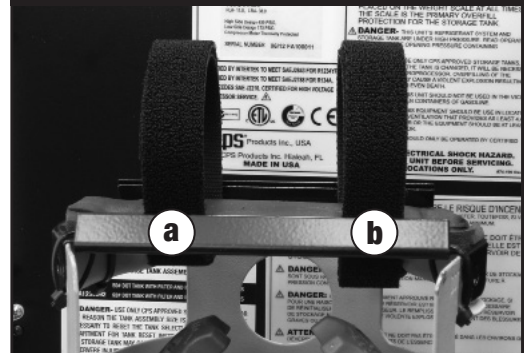

FIGURE - 2b Filter placed on filter bracket

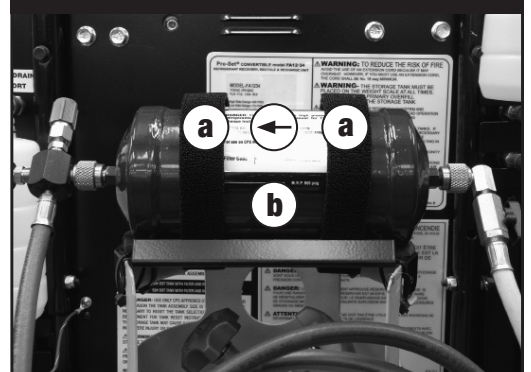
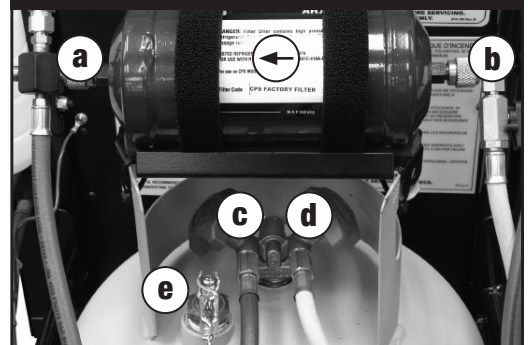

FIGURE - 2c Hose routing between filter, tank, and unit



FA1000 INITIAL SET-UP

The following instructions will guide you through the initial set up fo the unit that allows changes to operational software, language and units of measure.

Before we power up the unit, it will be necessary to check the vacuum pump oil sight glass for the correct level. The vacuum pump is pre-filled at the factory. Make sure the vacuum pump power switch is in the ON position. Also check the hose connecting to the vacuum pump is tight.

Make sure both Oil Injection (if equipped) and Oil Drain bottle assemblies are tight. Make sure the Oil Injection (if equipped) valve is in the **OFF** position.

Open all tank and hose valves on the back of the unit.

Plug the unit into the proper voltage power supply. Check the nameplate of the unit if there are any questions on power supply requirements.

While holding down the **Key #3**, push the momentary ON-OFF switch on the back of the unit until the LCD lights up.

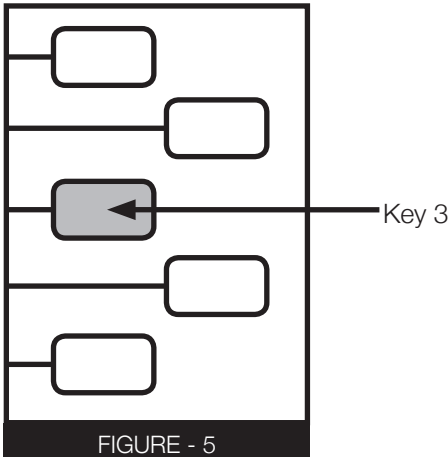

The LCD comes up with **SETUP MODE** screen asking for SAE or NON-USA.

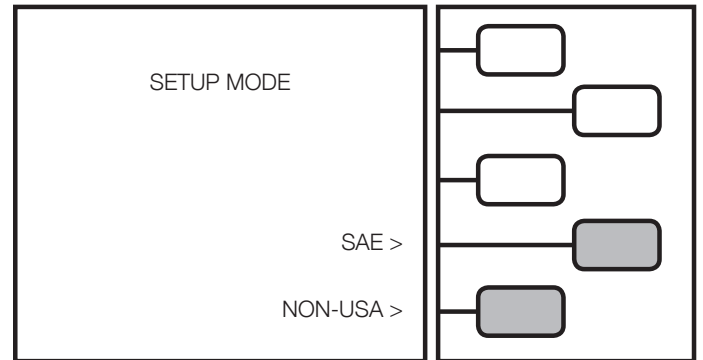

SAE applies to USA use. NON-USA would be used for anywhere outside of the USA. Keep in mind the operation of the unit is slightly different depending on which mode you use. Push either the **SAE** or **NON-USA** key for selection. Now the laguage selection screen comes up.

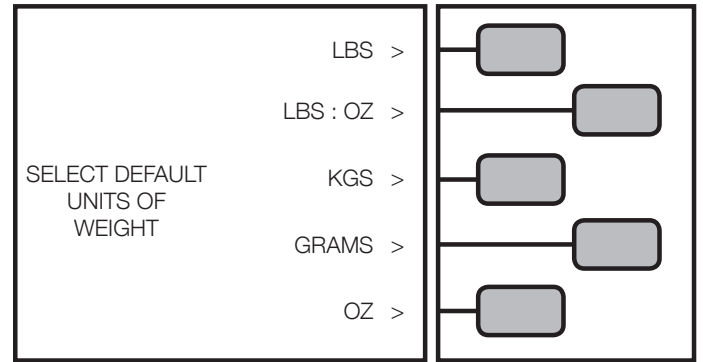
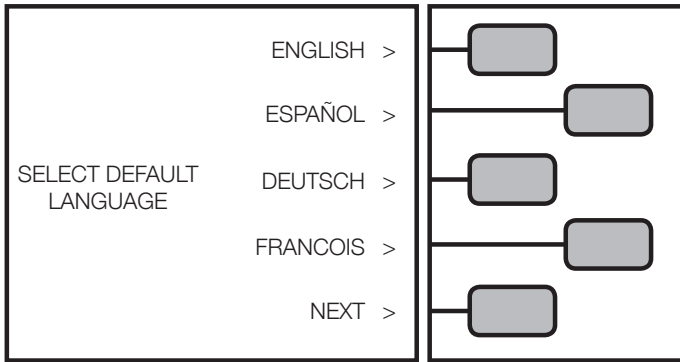

Push the key next to the desired language. The LCD will now show **SELECT DEFAULT UNITS OF WEIGHT**. Push the weight measurement system you are most likely to use. **Note: That during any Charge or Full Cycle operation, the UNIT OF WEIGHT can be temporarily changed.**

The unit will proceed to the automatic PT (Pressure Transducer) calibration and then (if required) the air purge. This should only take a few minutes and once complete the **MAIN MENU** will appear on the LCD.

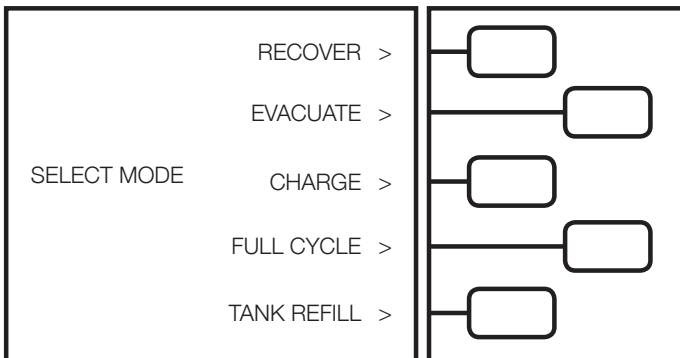

FA1000 is now ready for R-134a operation.

Place the R-134a ID tank label on the storage tank. Then go to page 18 to fill the recovery tank with R-134a.

OPERATING INSTRUCTIONS FOR THE FA1000

IMPORTANT: BEFORE USING THIS START UP GUIDE IT IS HIGHLY RECOMMENDED THAT THE USER COMPLETELY READ AND UNDERSTAND THIS ENTIRE MANUAL. FAILURE TO OPERATE AS SPECIFIED COULD RESULT IN DAMAGE TO THE UNIT, WHICH COULD ALSO LEAD TO LOSS OF WARRANTY.

The FA1000 is a microprocessor driven unit. The operating instructions are contained on the LCD. Simply choose the desired function of the unit and follow the directions on the LCD. The following are the basic instructions on safely operating each function of this unit.

Operating Instructions

Open all Storage Tank Valves. Make sure both Oil Injection (if equipped) and Oil Drain bottle assemblies are tight. Make sure the Oil Injection (if equipped) valve is in the **OFF** position. Push the momentary Power switch to (ON). The unit will run a brief diagnostic routine.

LCD will read: **RE-Zeroing PT, Please wait**. Once done with PT calibration process, the unit will proceed to the automatic air purge sequence. This will take up to 3 minutes.

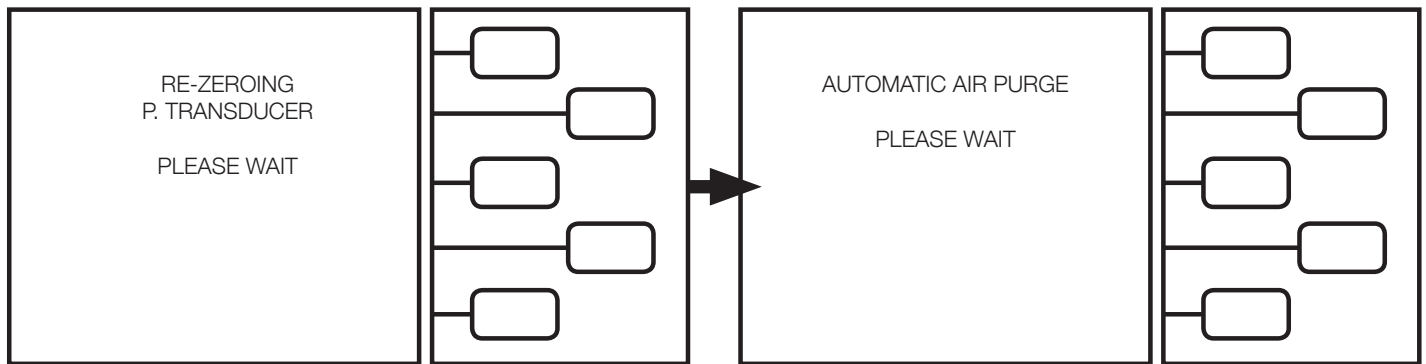

The LCD screen should now read:
This is called the **MAIN MENU**.

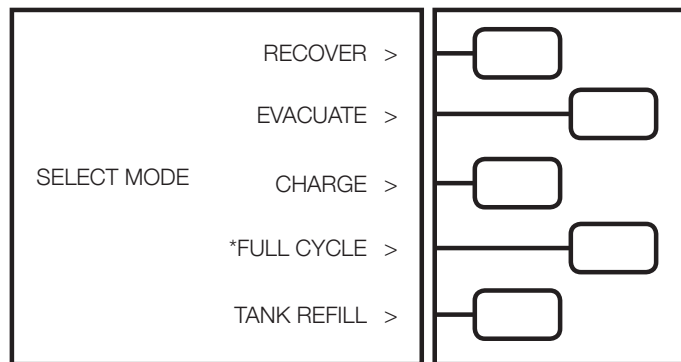

- Connect the refrigerant service hoses to the automobile A/C system to be serviced.
- Open the High and Low side service couplers.

Push the **KEY** for the desired mode.

The different modes are as follows:

1. Recover
2. Evacuation (Vacuum)
3. Charge
4. Full cycle
5. Tank refill

Follow the directions on the LCD for each mode. The following pages will discuss the operation of each mode in detail.

OPERATING INSTRUCTIONS FOR THE FA1000

RECOVER MODE: The Recover/Recycle mode would be chosen to recovery refrigerant from an Auto A/C system that needs a refrigerant containing component replaced such as a compressor, evaporator, orifice tube, condenser, etc....

IMPORTANT: Before starting the recover of the refrigerant, a refrigerant identifier should be used to determine the type and purity of the refrigerant. Failure to properly identify the refrigerant could potentially expose the user to danger from flammable refrigerants and health hazards from toxic refrigerants. Cross contamination of refrigerants can also occur and would require special handling of the refrigerant.

From the Main Menu screen,
Push the **RECOVER** key.

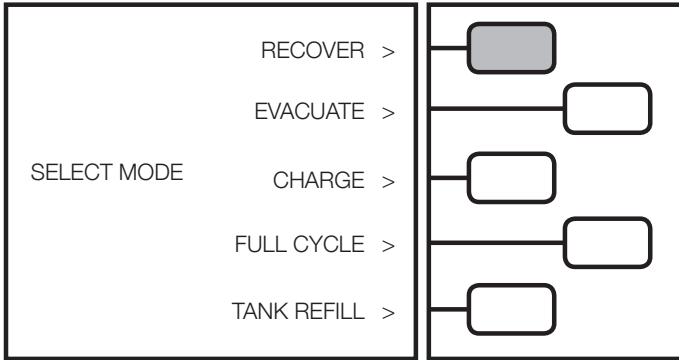

The LCD will now read:
Push the **START** key.

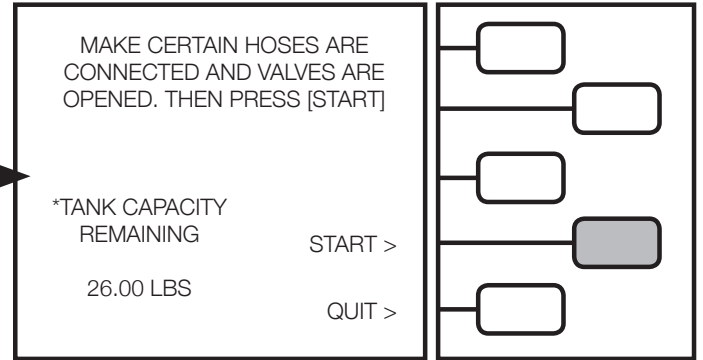

The LCD will now read:
The unit is now recovering refrigerant.
The LCD will show the amount of refrigerant recovered.

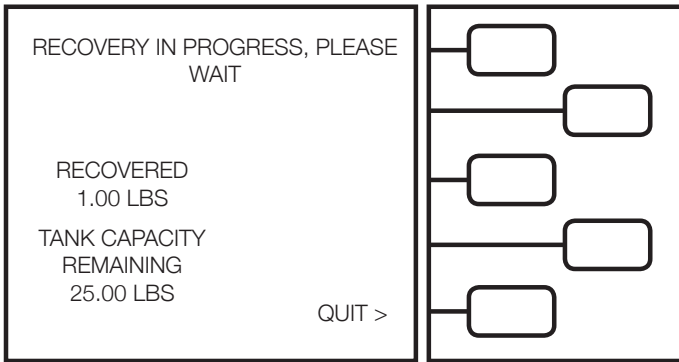

When the unit reaches approximately 20" hg. vacuum.
The LCD will now read:
The unit will proceed to drain the recovered oil:

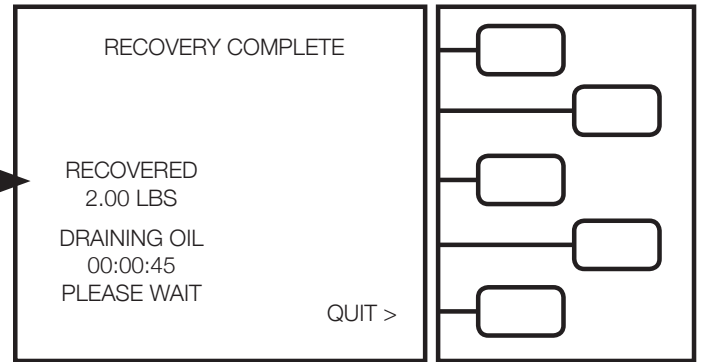

Record the **RECOVERED** weight reading on the LCD. Push the **QUIT** key to return to **MAIN MENU** (as shown below) or **PROCEED TO EVACUATE** key for evacuation operation. Do not forget to measure the A/C oil in the oil drain bottle for future A/C oil re-injection. **RECOVER/RECYCLE** Operation is now complete.

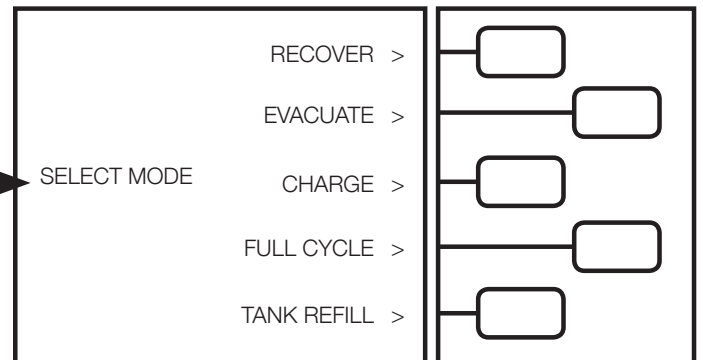
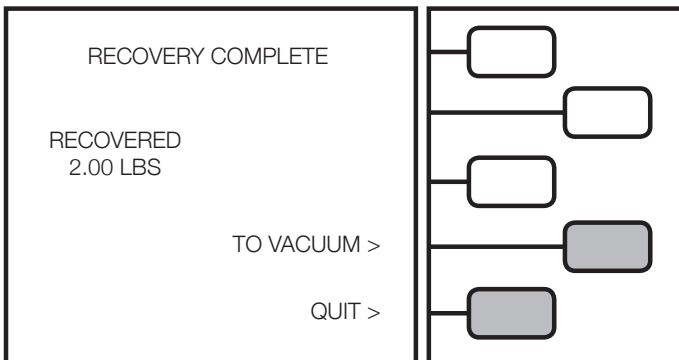

* TANK CAPACITY REMAINING - is the amount of space available in storage tank.

OPERATING INSTRUCTIONS FOR THE FA1000

EVACUATE MODE: The EVACUATE Mode would be chosen to remove air and moisture from an Automobile A/C system that has been open to the atmosphere. **CAUTION: Air and moisture in an A/C system can cause premature failure of A/C system components.**

From the Main Menu screen,
Push the **EVACUATE** key.

The LCD will now read:
Push the + or - ARROW keys until the desired vacuum time is programmed. Once done, push the **START** key.

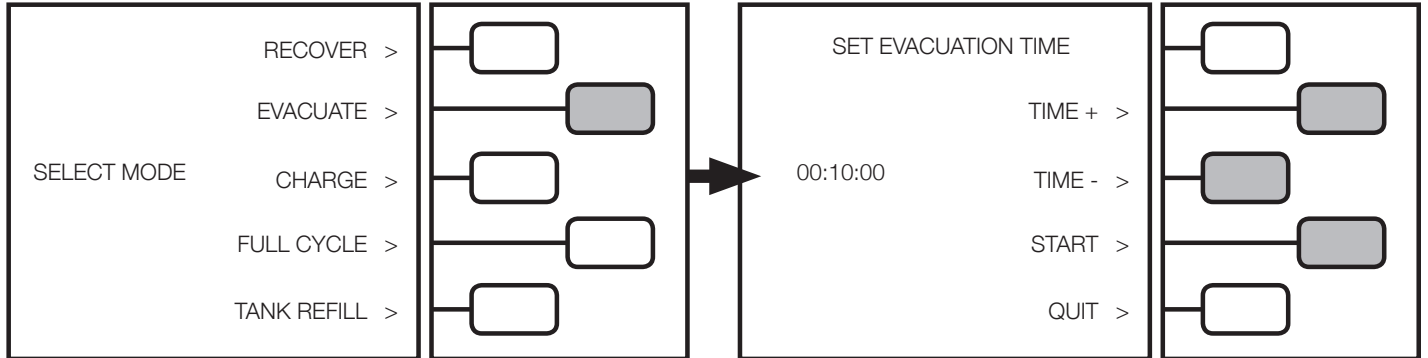

The LCD will now read:
The vacuum pump will run until the
TIME REMAINING reaches 00:00

The unit will then proceed to a 2:00 minute leak check test.
The LCD will now read:

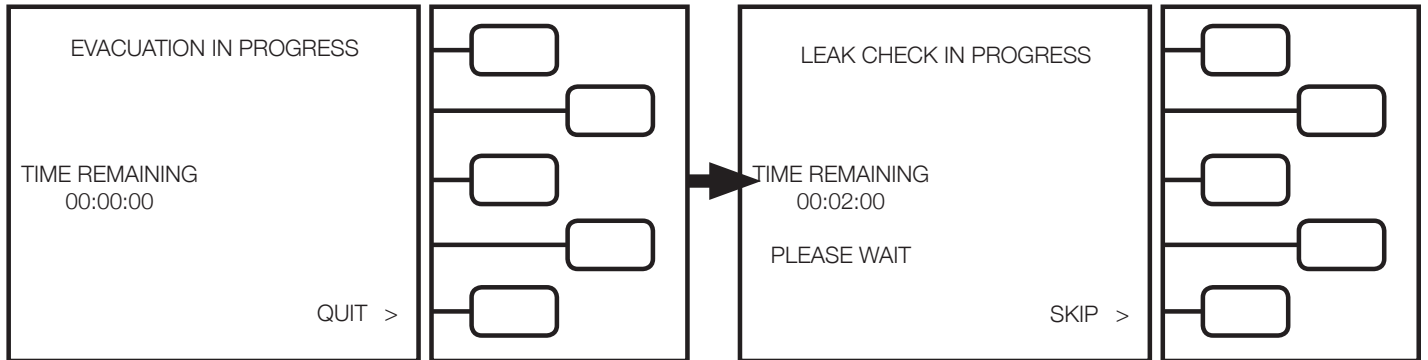

If leak check fails, check A/C system for leaks.
If leak check passes
The LCD will now read:

Push the **QUIT** key to return to Main Menu or **CHARGE** key for charge operation.

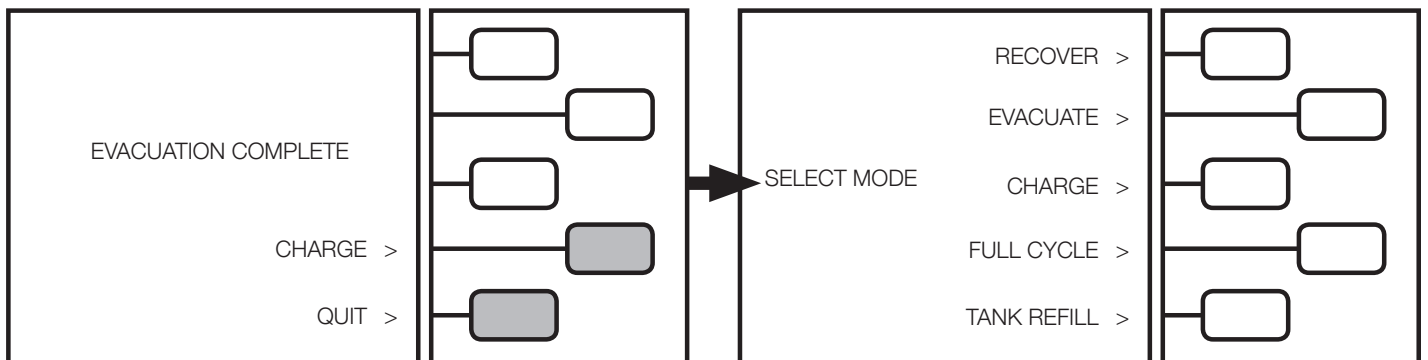

NOTE: If a leak is detected, the LCD will be prompted.

OPERATING INSTRUCTIONS FOR THE FA1000

CHARGE MODE: The CHARGE mode would be chosen to recharge a mobile A/C system after it has been properly evacuated. This is also the time to inject oil back into the A/C system. **See special instructions on page 23 for High Voltage Compressor A/C system charging.**

From the Main Menu screen,
Push the **CHARGE** key.

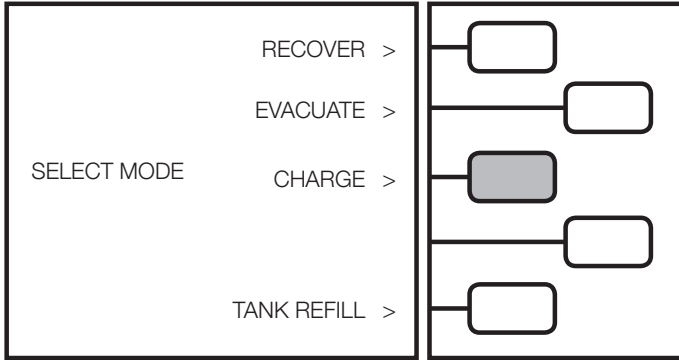

The LCD will now read:

Select which service hose unit should charge through. It is recommended to use **HIGH SIDE** charging to prevent compressor slugging.

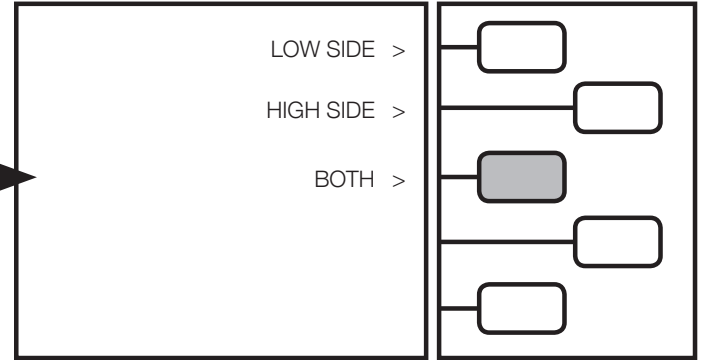

The LCD will now read:

If desired, the units of measure can be changed at this time. Push the **CHANGE UNITS** key.

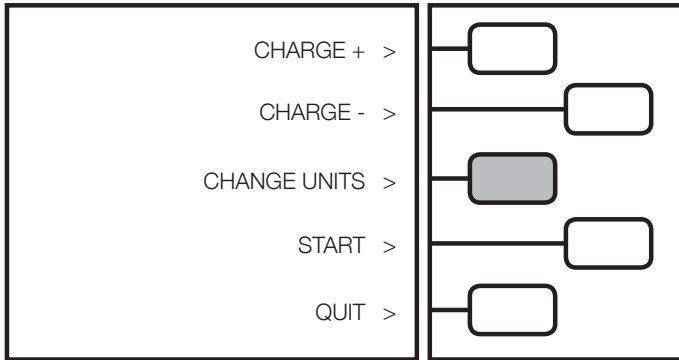

If the **CHANGE UNITS** key is pushed, the LCD will read:
Select units of measure.

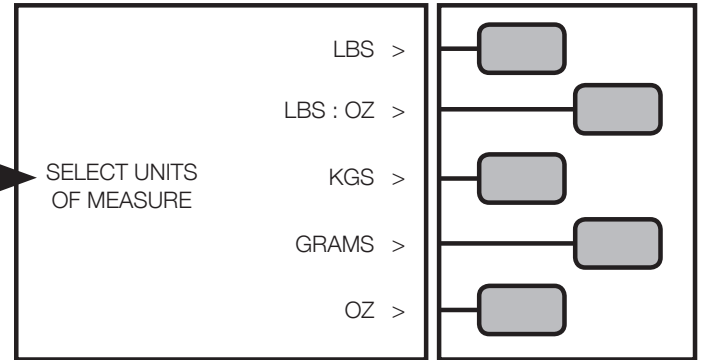

Continue by pushing the + or - ARROW key until the charge amount is programmed. Once desired amount is programmed, push the **START** key.

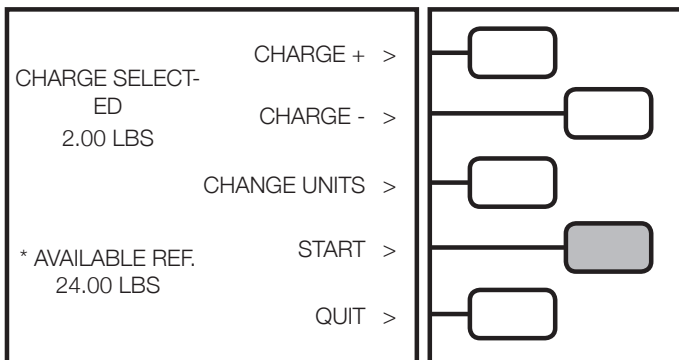

For model FA1000/FA1000B, use the 481500 Oil/Dye injector kit to inject oil into the mobile A/C system. For all other models, use the integrated oil injection bottle to add oil into the mobile A/C system.

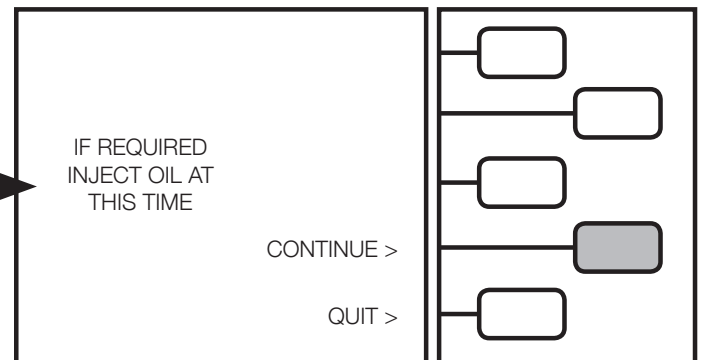

* AVAILABLE REF. This is the amount of refrigerant available for charging. If this drops below zero, charging will not start.

OPERATING INSTRUCTIONS FOR THE FA1000

The LCD will now read:
The **CHARGE DISPENSED** reading will begin to increase.

Note: If the unit does not completely dispense the charge into the A/C system, the LCD will notify the user of options to complete the charge.

Once the CHARGE DISPENSED equals the CHARGE.
The LCD will read: Close HIGH SIDE COUPLER.
Push **CONTINUE** key.

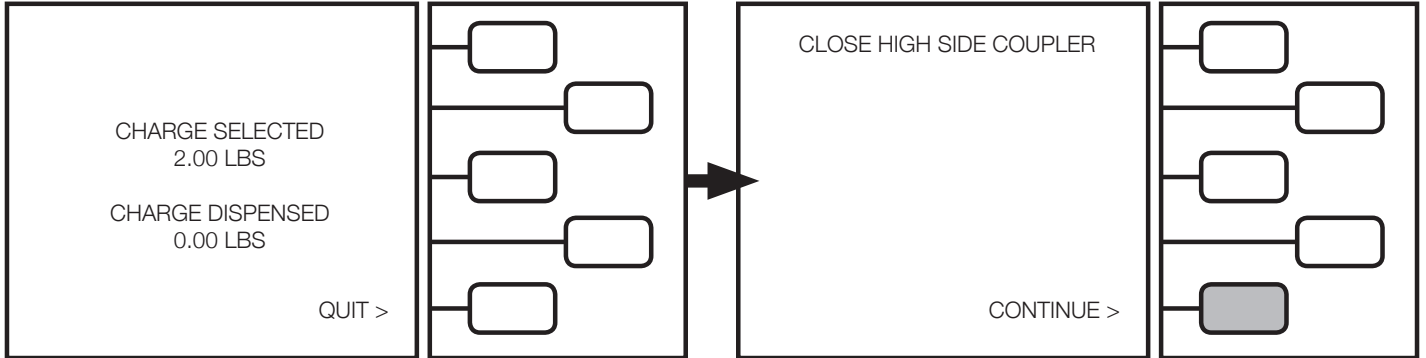

Start car A/C system, Push **CONTINUE** key.

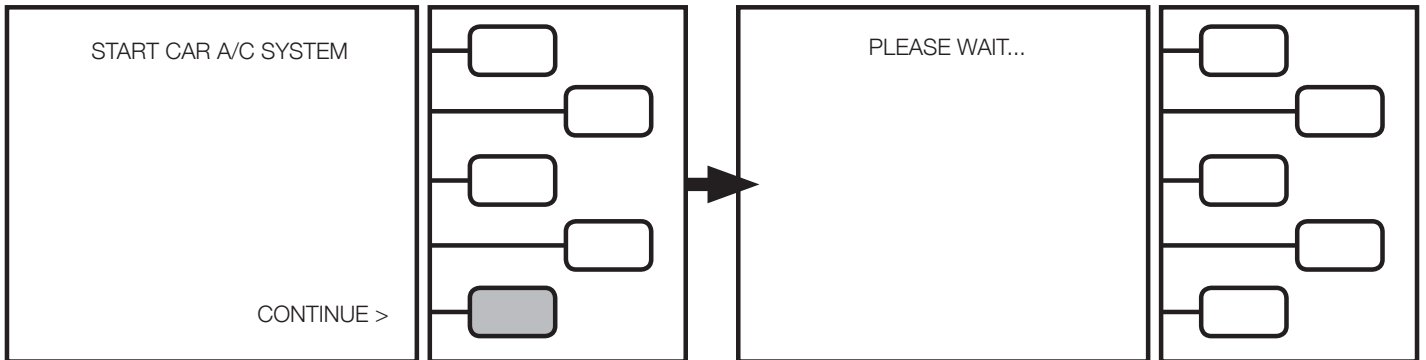

Charge is now complete. Push **QUIT** key to return to **MAIN MENU**.

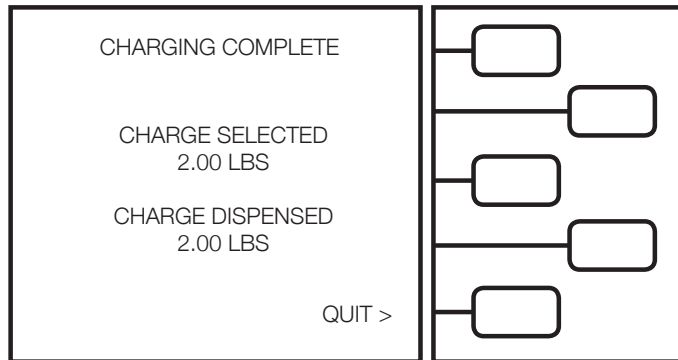

OPERATING INSTRUCTIONS FOR THE FA1000

FULL CYCLE: The fully automatic mode is commonly used at quick car care service facilities where no leaks or repairs are required, but the A/C system seems to be undercharged.

IMPORTANT: Before starting the recover of the refrigerant, a refrigerant identifier should be used to determine the type and purity of the refrigerant. Failure to properly identify the refrigerant could potentially expose the user to danger from flammable refrigerants and health hazards from toxic refrigerants. Cross contamination of refrigerants can also occur and would require special handling of the refrigerant.

From the **MAIN MENU** screen,
Push the **FULL CYCLE** key.

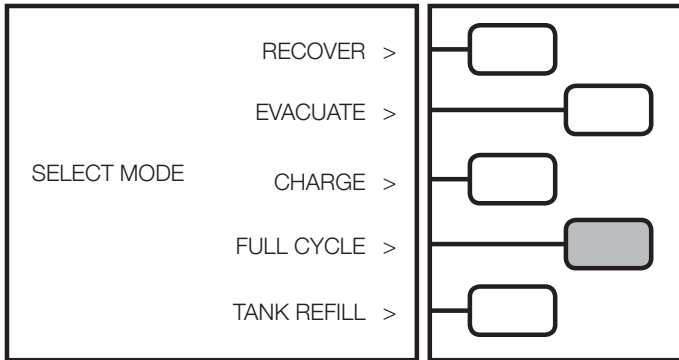

The LCD will now read:
Push the + or - ARROW keys until the desired vacuum time is programmed. Push the **NEXT** key.

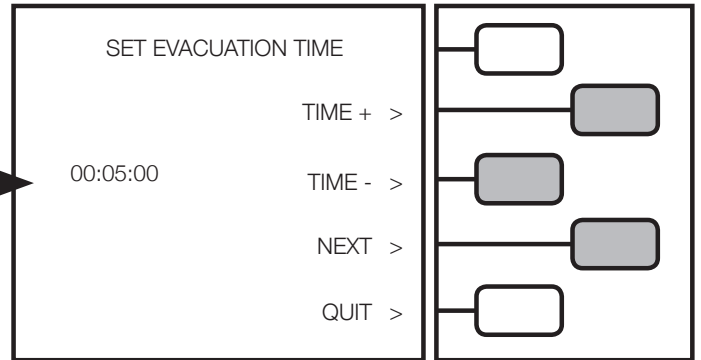

The LCD will now read:
If oil injection is required, push the **YES** key.
Otherwise push the **NO** key. If the YES key is pushed,
you will be notified when to inject the oil.

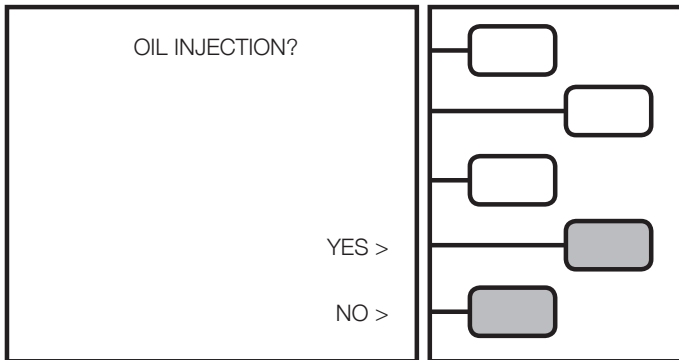

The LCD will now read:
If desired, the units of measure can be changed at this
time. Push the **CHANGE UNITS** key.

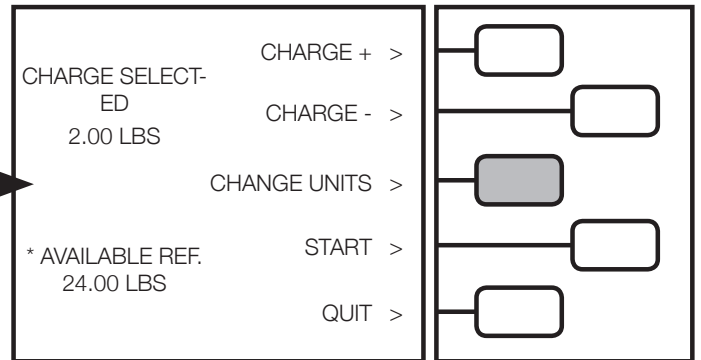

OPERATING INSTRUCTIONS FOR THE FA1000

If the **CHANGE UNITS** key is pushed, the LCD will read:
Select units of measure.

The LCD will now read:
Continue by pushing the + or - ARROW key until the charge amount is programmed. Once desired amount is programmed, push the **START** key.

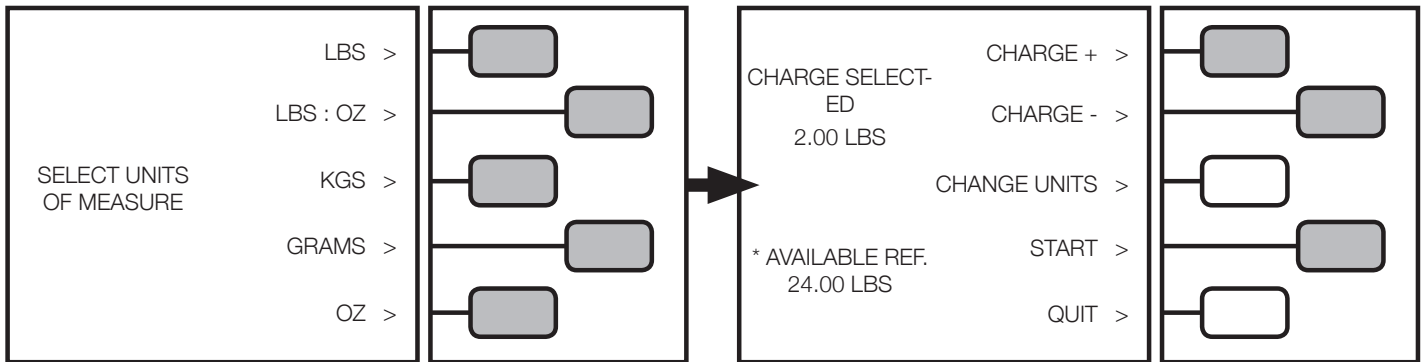

The LCD will now read:
The unit is now recovering refrigerant.
The LCD will show the amount of refrigerant recovered.

When the unit reaches the required vacuum level, the unit will proceed to drain the recovered oil:
The LCD will now read:

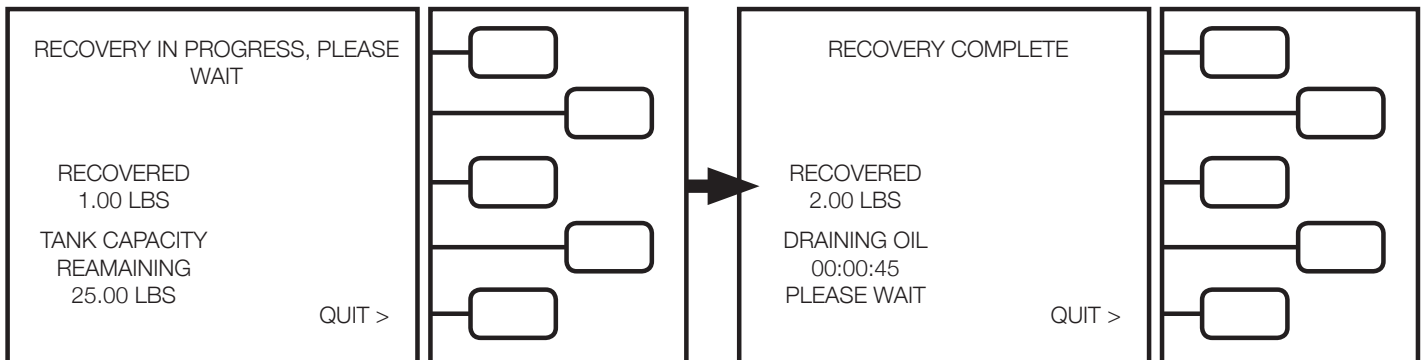

* AVAILABLE REF. This is the amount of refrigerant available for charging. If this drops below zero, charging will not start.

* TANK CAPACITY REMAINING - is the amount of space available in storage tank.

OPERATING INSTRUCTIONS FOR THE FA1000

Once **DRAINING OIL** is complete, the unit will proceed to **Evacuation**. The vacuum pump will run until the **TIME REMAINING** reaches **00:00**. The LCD will now read:

The unit will proceed to a 2:00 minute leak check test. The LCD will now read:
Note: If leak check fails, check A/C system for leaks. The FULL CYCLE process will be aborted.

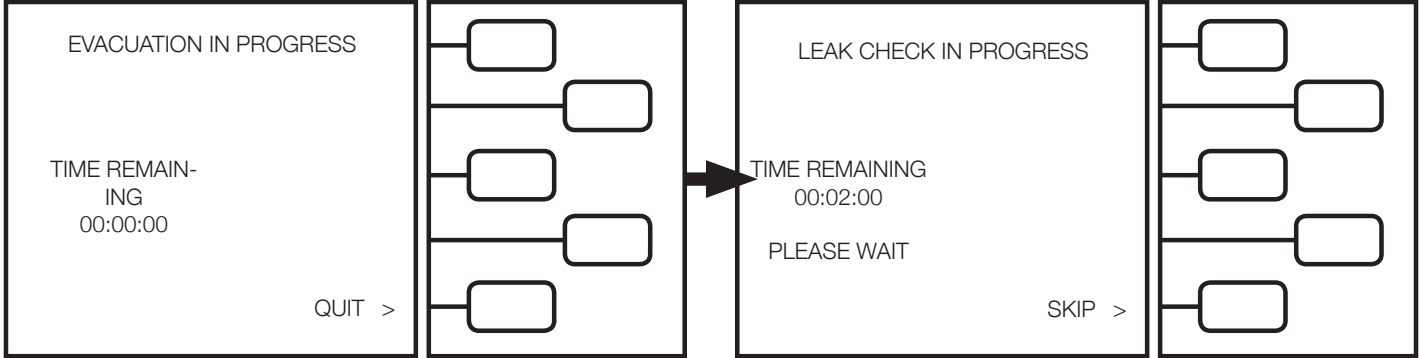

Once the **LEAK CHECK** has passed or the **SKIP** key is pushed, The LCD will read:
 For model FA1000/FA1000B, use the 481500 Oil/Dye injector kit to inject oil into the mobile A/C system. For all other models, use the integrated oil injection bottle to add oil into the mbobile A/C system.

The LCD will now read:
 The **CHARGE DISPENSED** reading will begin to increase.
Note: If the unit does not completely dispense the charge into the A/C system, the LCD will notify the user of options to complete the charge.

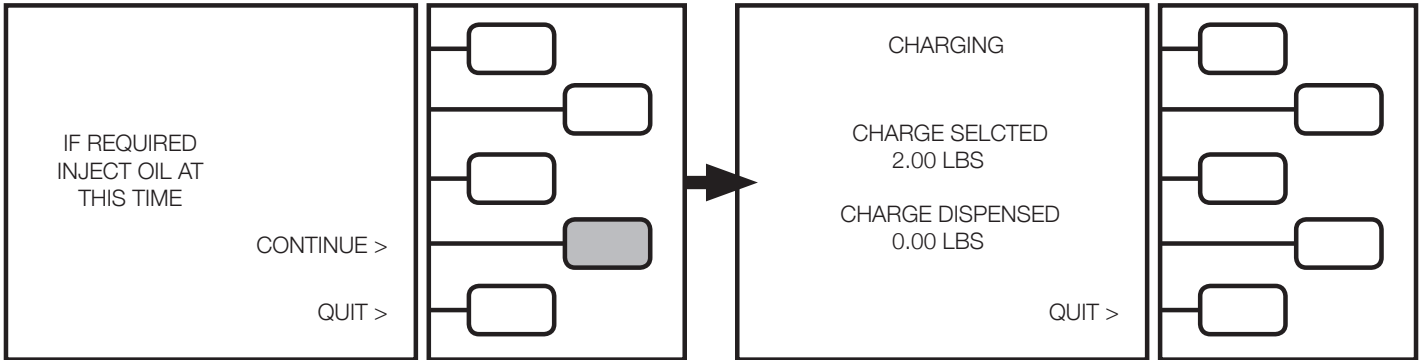

Once the CHARGE DISPENSED equals the CHARGE. The LCD will read: Close HIGH SIDE COUPLER. Push **CONTINUE** key.

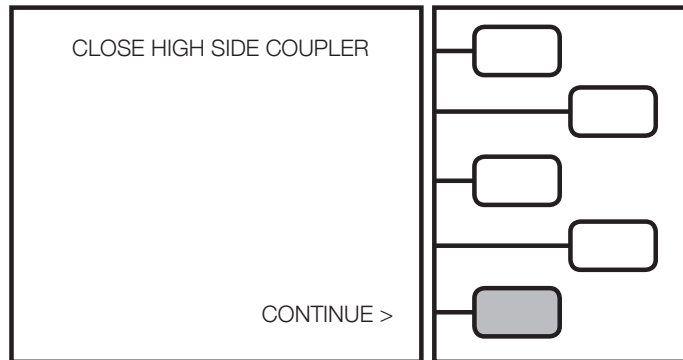

OPERATING INSTRUCTIONS FOR THE FA1000

Start car A/C system, Push **CONTINUE** key.

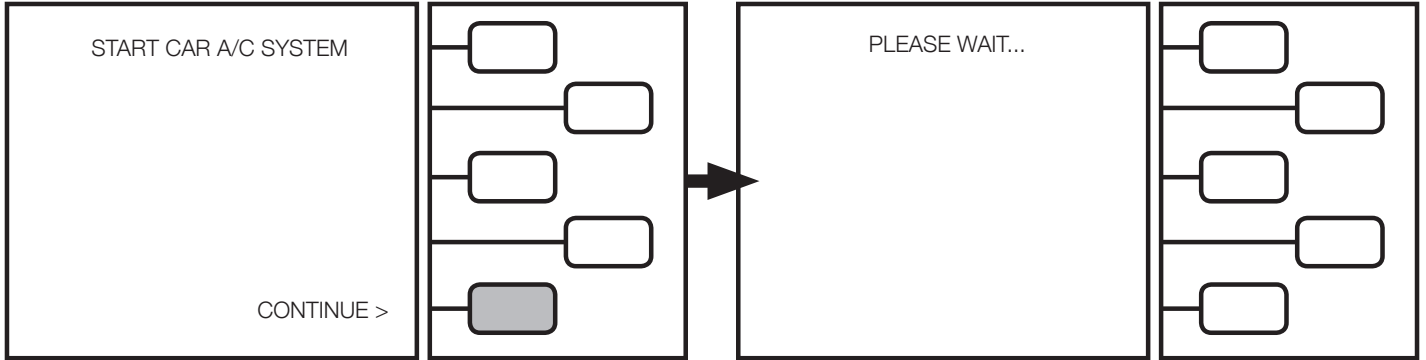

Once the charge amount has been met, The LCD will read:
Record the data on the LCD. Push the **QUIT** key.
FULL CYCLE is complete.

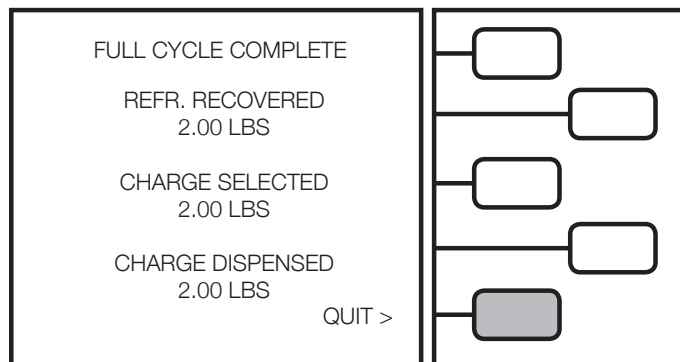

The LCD will return to the **MAIN MENU**.

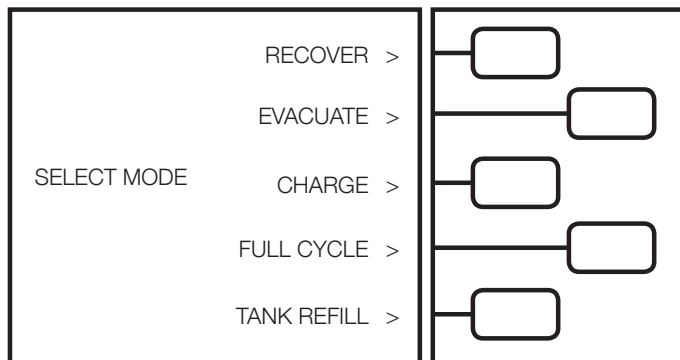

OPERATING INSTRUCTIONS FOR THE FA1000

REFILL MODE: The REFILL mode would be chosen to add refrigerant to the tank for the first time or add more refrigerant to the recovery tank. This operation can be run pushing the **TANK REFILL** key from the **Main Menu** or may be prompted when insufficient refrigerant exists when in **CHARGE** or **FULL CYCLE** modes. It's recommended to use a refrigerant identifier on the virgin supply tank to guard against counterfeit refrigerants.

From the **MAIN MENU**,
Push the **TANK REFILL** key.

The LCD will now read:
Connect the High Side service hose to a virgin supply tank. Push the **START** key.

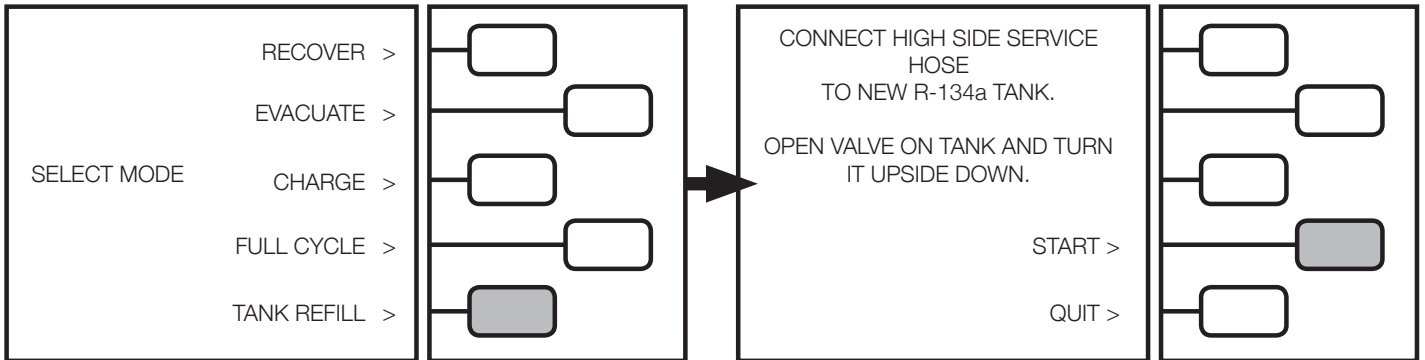

Note: To speed up the Refill process, turn the supply tank upside down or make sure the liquid refrigerant is being recovered.

The LCD will now read:

Caution: Do not turn off unit. If stoppage is required, close the HIGH SIDE COUPLER and all the unit to complete the clearing process.

If **REFILLING** amount reached zero, the LCD will read:
Push the **Quit** Key to return to **MAIN MENU**.

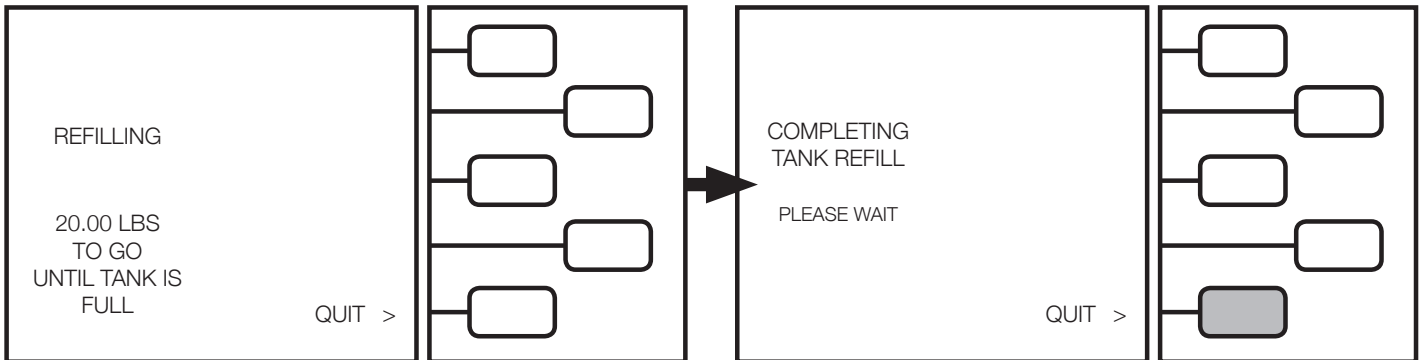

The unit will run until: 1. REFILLING amount on LCD reaches zero or 2. Virgin supply tank is pulled into a vacuum

If Virgin supply tank is pulled into a vacuum,
the LCD will read:

Either add a new Virgin supply tank and push **RESUME** or
Push the **QUIT** key to return to **MAIN MENU**.

Pushing the **QUIT** key will return to the **MAIN MENU**.

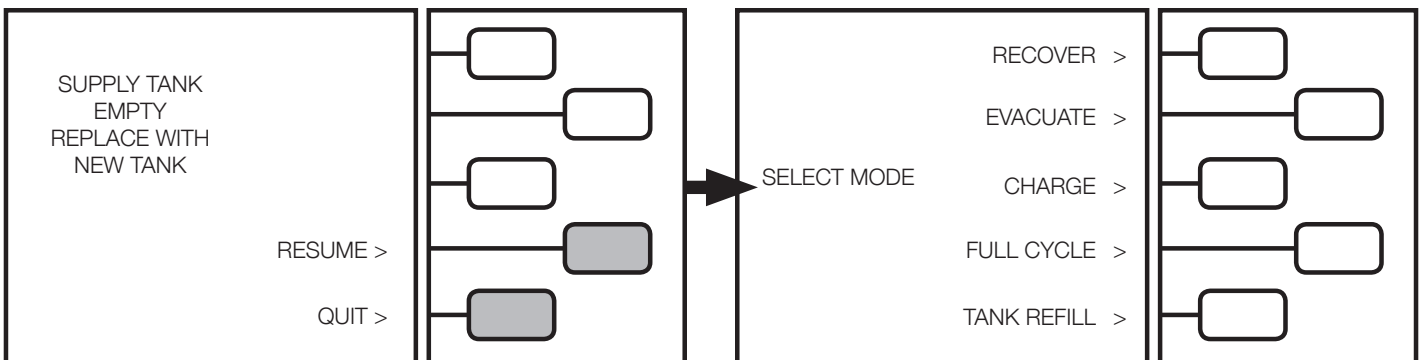

MAINTENANCE

MAINTENANCE MODES: DURING NORMAL OPERATION OF FA1000

FILTER CHANGE: The FA1000 uses a mass flow tracking system on how much recovered refrigerant has passed through the Filter Drier (CPS p/n ARXF5). Each 41 Cubic Inch Drier can handle 150 lbs. of refrigerant before requiring change. When it is determined that the filter has exceeded the 150 lbs., the unit locks out (if in SAE mode) the recovery function in both RECOVERY and FULL CYCLE. It is necessary to purchase a Filter Drier under CPS p/n ARXF5. Each new Filter Drier comes with a unique code to unlock the recover/recycle function. The FA1000 has a lower tilt drawer design to hold 2 spare filters.

When choosing the RECOVER or FULL CYCLE modes, the unit will remind the user to order a filter when the FILTER LIFE REMAINING is below 25%. The following is an example of the LCD when Filter Life is less than 25%: Push the **CONTINUE** key to proceed to filter change.

When the Filter Life reaches 0%, the following LCD screen will come up. Push the CHANGE FILTER key to begin filter change procedure.

Note: pushing QUIT key at this time will return the unit to the Main Menu. While in the SAE mode, all functions except RECOVER and FULL CYCLE are active. To unlock RECOVER and FULL CYCLE modes, complete the filter change procedure).

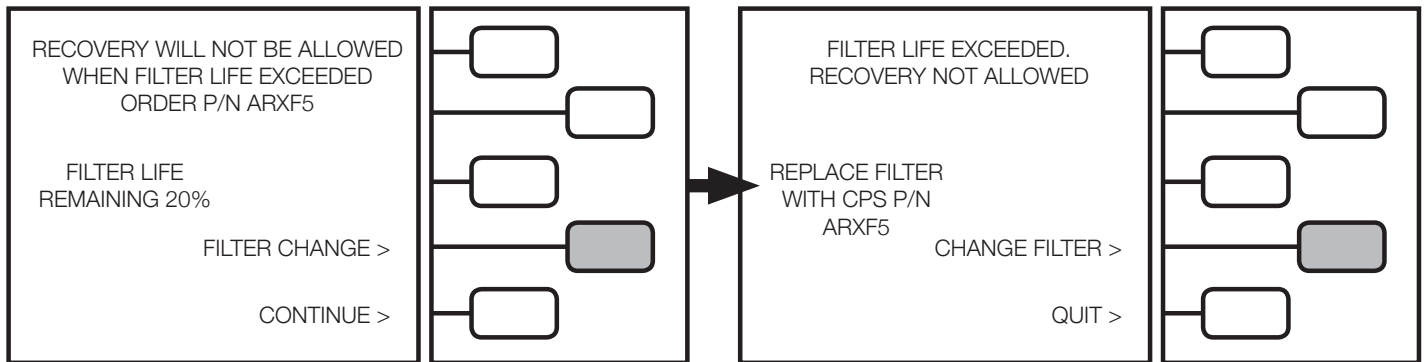

The LCD will now read:
Push the **START** key to begin Filter Change routine.

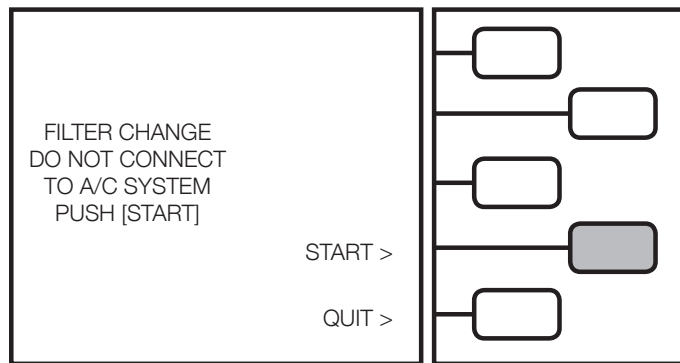

The LCD will now read:
After closing liquid port tank valve, push **CONTINUE** key.
Hint: To speed up filter cleaning, remove the filter from the bracket. Hang the filter so the hose coming from the back of the unit is on the bottom.

The LCD will now read:
The evacuation process will take about 2-5 minutes.
The unit will run until a filter has been evacuated.

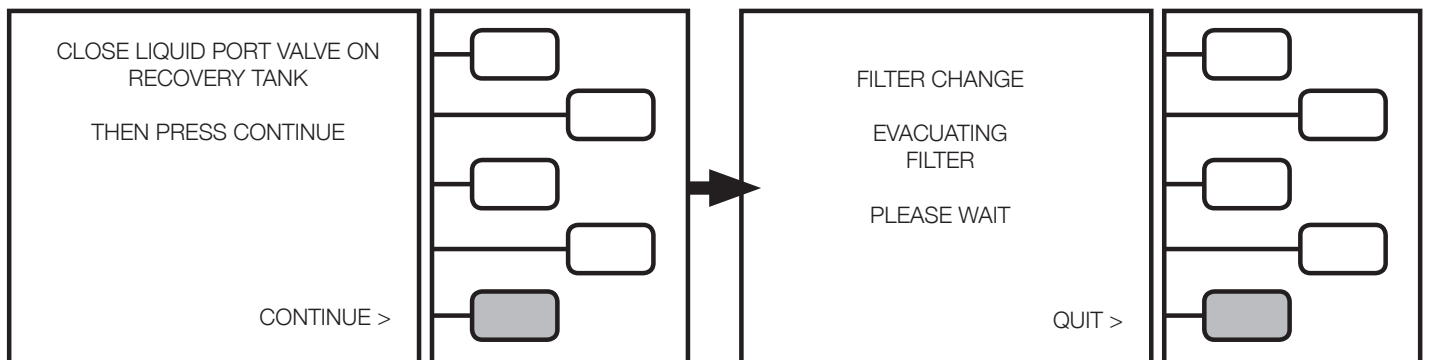

MAINTENANCE

AUTOMATICALLY OCCURRING DURING THE OPERATION OF THE UNIT

FILTER CHANGE (continued):

Once the filter has been evacuated, the LCD will read:
 Replace the filter with new ARXF5. Make sure the **ARROW** on the filter points away from the Tank Liquid supply.
 Then Push the **NEXT** key:

LCD will now read:
 Use the +, -, KEYS to fill in the filter code for each blank.
 Use the <, > KEYS to move cursor to the next blank
 See filter label for code.

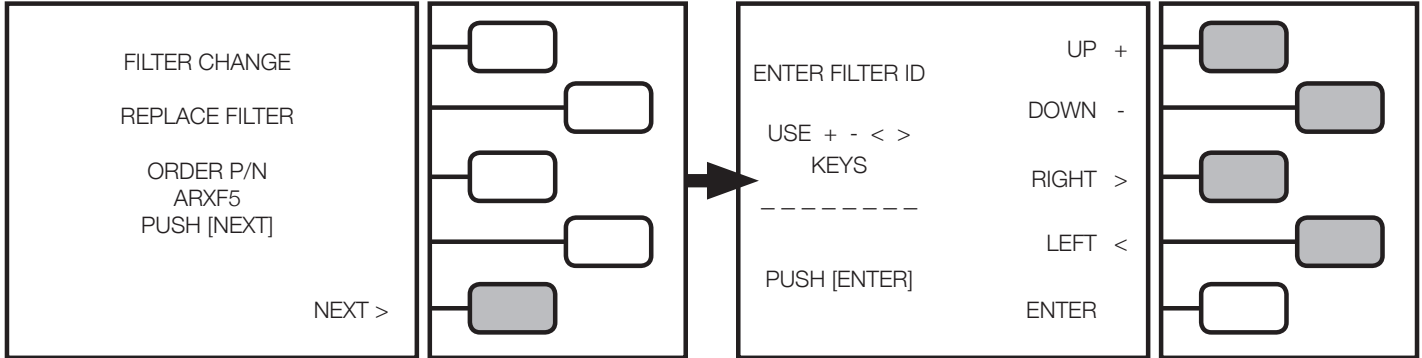

Push the **ENTER** key once the entire code is shown on LCD.

The LCD will now read:
 Filter Change is now complete. Push the **QUIT** key to return to **MAIN MENU**.

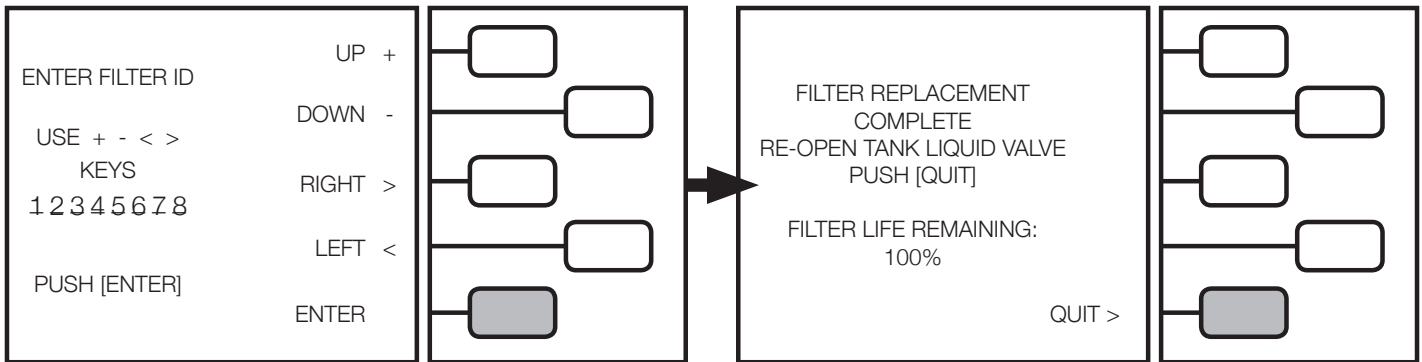

VACUUM OIL CHECK:

Every 10 hours of vacuum pump run time the following message will appear in **EVACUATION** or **FULL CYCLE** modes. The oil level can be seen through the sight glass of the vacuum pump. To change the oil, first loosen the wing nut under the frame and then slide the vacuum pump out. The vacuum pump oil should be clear, use CPS vacuum pump oil p/n VPOP, VPOQ, VPOG. Make sure the oil level is up to the fill mark on the oil sight glass. Push **CONTINUE** key to proceed to the **EVACUATION** or **FULL CYCLE** modes.

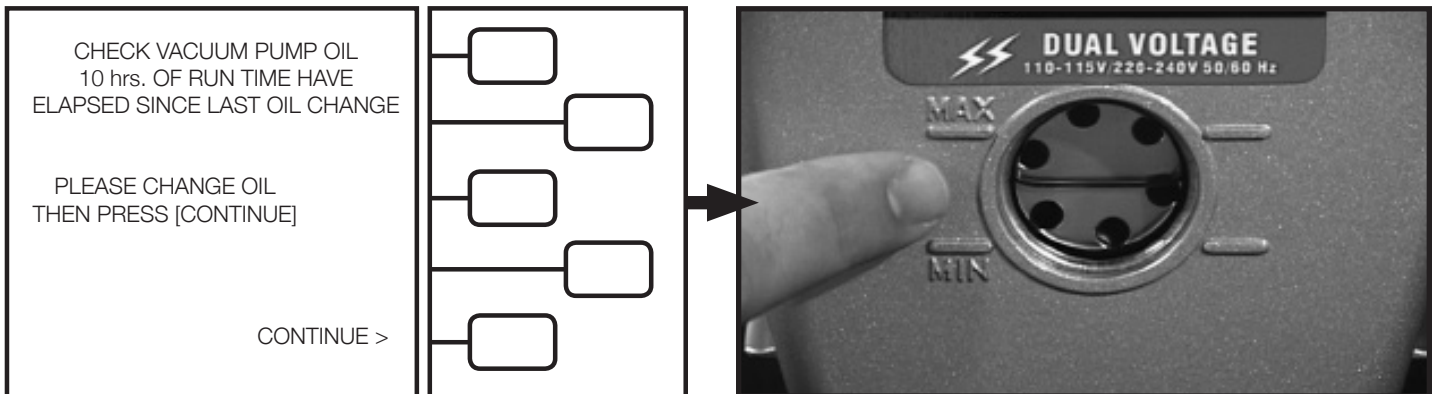

Automatic Non-condensable Gases (NCG) Purge: Upon start up of the unit, the NCG purge will begin automatically. If the compressor was recently run, it could take up to 30 minutes before the NCG routine is allowed to run. To perform this operation, simply turn the unit off and back on.

MAINTENANCE VIA KEYPAD OPERATION

To enter into the units **MAINTENANCE** mode, hold down **Key 2** and then turn power switch on.

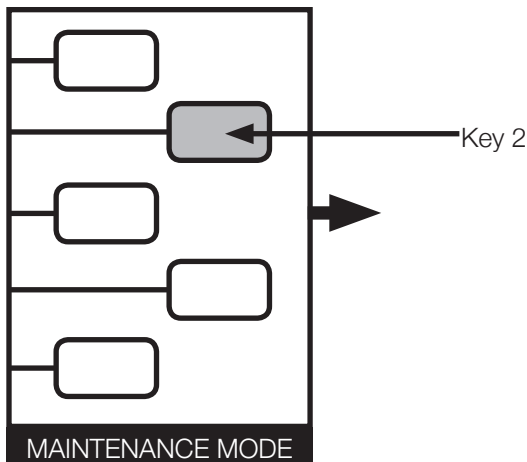

The LCD will now read:

FILTER CHANGE: Push the **CHANGE FILTER** key.

Go to page 21 for detailed FILTER CHANGE instructions.

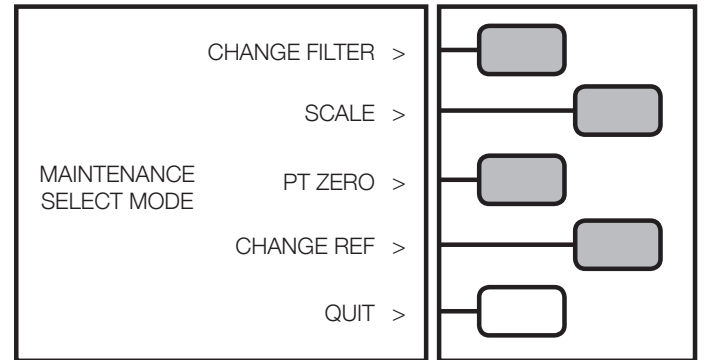

SCALE CHECK:

Push the **SCALE** key. The LCD will now read:
Push the **YES** key to proceed with accuracy check.
Pushing the **NO** key will skip the accuracy check and proceed to the **Re-Zeroing** function.

The LCD will now read:

Place Calibration Weight on tank.

Push the **YES** key if weight reading matches Calibration weight.
(Push the **NO** key if weight does not match. See service manual for complete scale re-calibration procedure. A 25LB or 15KG Class F weight will be required for scale re-calibration).

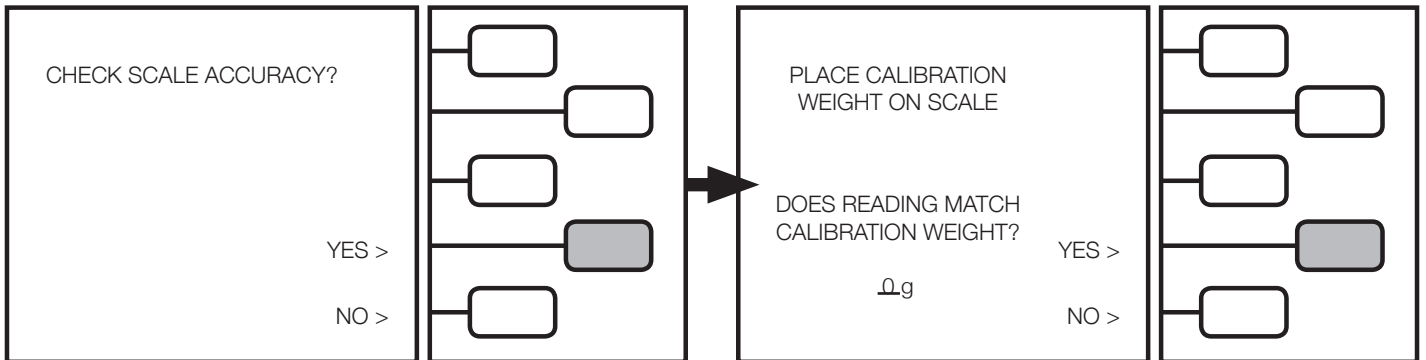

The LCD will now read:

Push the **YES** key to proceed with **RE-ZERO** scale.

Note: Pushing the NO key will prompt the unit to reboot and Go to MAIN MENU.

LCD will now read:

Lift the Tank off the scale.

Then Push **NEXT** key.

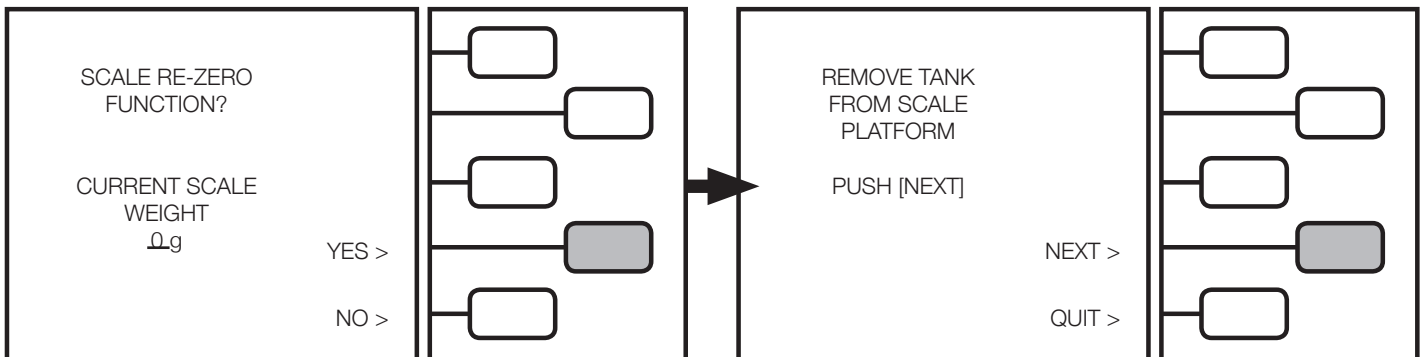

MAINTENANCE

The LCD will now read:
Wait until the LCD screen changes.

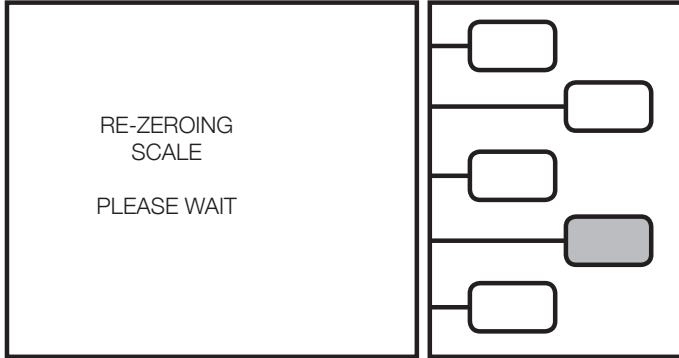

NOTE: Keep tank off scale platform

The LCD will now read:
Push the **YES** key if **CURRENT SCALE WEIGHT** is zero.
The unit will re-boot and go to the **MAIN MENU**.
Pushing the **NO** key will repeat Re-Zeroing process.

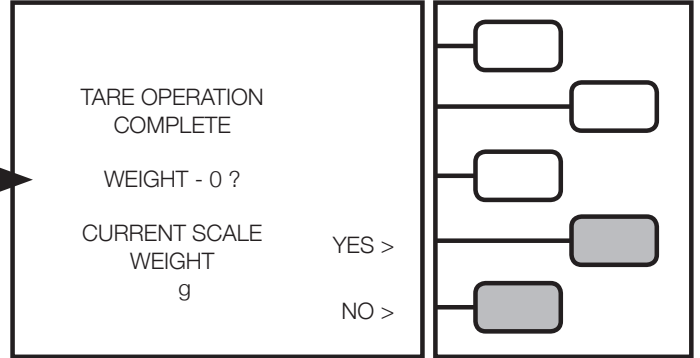

NOTE: Once complete place tank back on scale platform

PT SENSOR/GAUGES:

Push the **PT SENSOR** key.
The FA1000 will begin a automatic routine
to recalibrate the Pressure Transducer (PT).

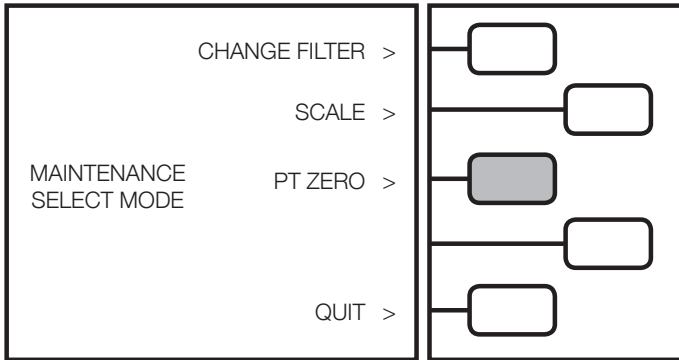

The LCD will now read:
Wait for Re-zeroing procedure to complete.

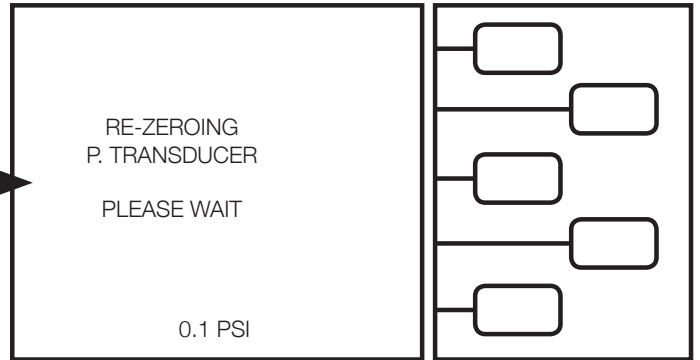

The Pressure Transducer (PT) calibration will automatically complete the procedure.
Once done, the LCD will return to the **MAIN MENU**:

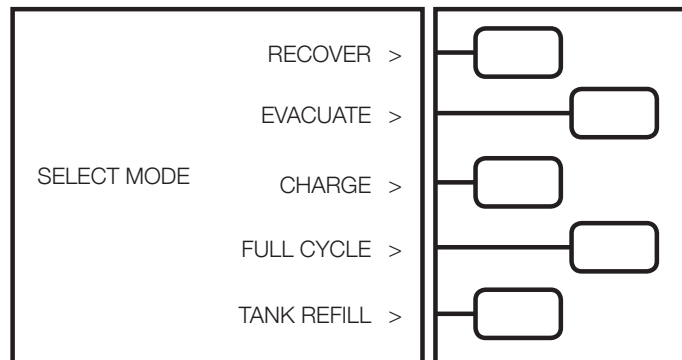

HIGH VOLTAGE A/C CHARGING INSTRUCTIONS

OEM manufacturers of Automotive High Voltage A/C systems have required that the residual amount of PAG oil in the charging hose(s) be reduced to a minimal level. The following are instructions on how to prepare the FA1000 for charging a High Voltage A/C system:

- Step 1: Remove the oil injection (if equipped) assembly from the FA1000 injection port. Cap off this
- Step 2: Push the **REFILL** key. Do not hook up the service hoses as instructed by the LCD.
- Step 3: Push the **START** key. Run until **RESUME** and **QUIT** keys come up on the LCD.
- Step 4: Connect both **HI** and **LO** service hoses to the auxiliary fittings (**a-b**) on the hose between the filter and tank liquid port as shown in **Fig 3**.
- Step 5: Push the **RESUME** key.
- Step 6: Open both **HI** and **LO** service coupler valves.
- Step 7: Run for 30 minutes.
- Step 8: After 30 minutes close both **HI** and **LO** couplers.
- Step 9: Allow the **REFILL** mode to complete the evacuation of the hoses.

The unit is now ready to charge a High Voltage A/C system. Following the CHARGING MODE instructions on page 12.

NOTE: When injecting oil back into a high voltage A/C system, use the OEM recommended oil. Purchase CPS injecting kit (AR2788X23) for additional injectors for different OEM oils.

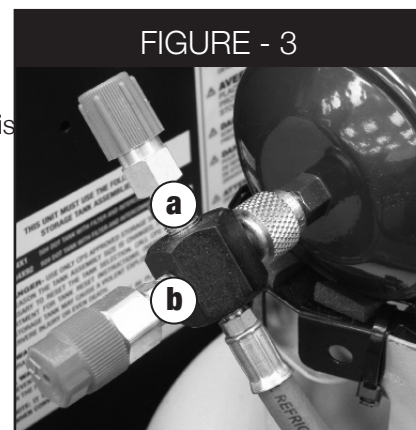

Connect service hoses to auxiliary ports on the liquid feed hose

HOSE MAINTENANCE

Maintenance - Interconnection Hoses, Service Hoses and Couplers: The FA1000 uses brass to brass seal type fitting on the ends of the service hoses and interconnecting hoses. No hose gasket maintenance is required on brass to brass type connections. The fittings connecting to the filter drier do use a rubber hose gasket. When changing the filter drier, check the gaskets for wear. Replace if required. Periodically inspect all refrigerant hose assemblies, service hoses and both service coupler inner o-rings for wear. Replace the component(s) if excessive wear or leakage is observed. Periodically leak-check all hose connection points, hose ball valves, and service couplers. Since the unit does pull vacuum in the recovery process, excessive Non-Condensable Gases (NCG's) could be sucked into the system and placed in the storage tank.

TROUBLE SHOOTING

- Problem:** High Pressure Limit.
- Solution:** Check that both Storage Tank valves are open. Check that any inline hose ball valves to the Storage Tank are open.
- Problem:** Tank Overfill.
- Solution:** Remove refrigerant from Storage Tank by charging into an empty refrigerant cylinder. If this does not fix the problem, then Re-Zero scale.
- Problem:** Unit not Charging accurately.
- Solution:** Make sure Storage Tank is properly placed on platform so that no portion of the tank is touching the back of the unit or protective frame work of the unit.
- Solution:** Do not move the unit while in the charging mode. The unit utilizes a weighing method of charging. Sudden movement of the storage tank will affect the charging accuracy.
- Solution:** Make sure unit is on a level surface. If placed on surface with more than 2% grade, the charging amount may be incorrect.
- Problem:** Unit will not power up.
- Solution:** Check to make sure circuit breaker on back of unit is not tripped. Reset and restart the unit if necessary.
- Solution:** Make sure power cord is plugged into the back of the unit and the wall receptacle.
- Problem:** Upon compressor start up, the circuit breaker trips.
- Solution:** Reset circuit breaker and try again.
- Problem:** Upon vacuum pump start up, the circuit breaker trips.
- Solution:** Check Oil Level in vacuum pump. Reset circuit breaker and try again.
- Solution:** Make sure vacuum pump voltage switch is in the correct position.
- Problem:** Unit stuck in PT calibration mode.
- Solution:** Check to make sure Oil Injection (if equipped) valve is close and firmly attached to the unit.
- Solution:** Make sure vacuum pump switch is ON. Make sure vacuum pump is plugged into the unit's receptacle.

For other problems, please call the CPS service network for further instructions.

SERVICE PARTS AND ACCESSORIES

Item	Description
39-020	115V 6" Fan
39-021	230V 6" Fan
54-100	Spare oil bottle
Item	Description
AR2788SX3	Scale module
AR2788SX11	AR2788S / FA1000 tank liquid to filter IN hose
AR2788SX17	Black scale patch cord
AR2788SX18	Red relay PCB patch cord
AR2788SX19	Yellow Low side block PCB patch cord
AR2788SX20	Green High side block PCB patch cord
AR2788SX21	Low side block PCB
AR2788SX22	High side block PCB
AR2788SX23	Main PCB
AR2788SX24	LCD
AR2788SX28	Oil injection assembly (all models except FA1000/FA1000B)
AR2788SX29	Tank filter bracket / straps
Item	Description
AR2788X14a	1/2" ACME tank refill adaptor
AR2788X14b	1/4" SAE tank refill adaptor
AR2788X16	Low side gauge kit
AR2788X17	High side gauge kit
AR2788X25	Scale PCB
AR2788X28	Power supply
AR2788X30	1lb. check weight
AR2788X32	15 AMP breaker 115 VAC
AR2788X33	10 AMP breaker 240 VAC
AR2788X34	ON / OFF momentary switch
AR2788X40	6 ft. power cord 115 VAC
AR2788X41	6 ft. power cord 240 VAC (Europe)
AR2788X45	High pressure switch 450 PSI
AR2788X46	Pressure transducer
AR2788X53	IEC heater blanket / vacuum pump outlet
AR2788X57	Gauge line repair kit
AR2788X64	Castor with brake
AR2788X65	10" wheel
AR2788X67	Charging orifice

AR27XHB15	115 volt 300 watt heater blanket
AR27XHB230	230 volt 300 watt heater blanket
ARXF5	Coded 41 cu in filter
Item	Description
FA1234X2	FA1000 compressor assembly 115V
FA1234X3	FA1000 compressor assembly 230V 50 Hz.
FA1234X4	FA1000 compressor assembly 100V
FA1234X5	AR2788 II / FA1000 oil drain bottle assembly
FA1234X6	AR2788 II / FA1000 Low side block complete
FA1234X7	FA1000 High side block complete
FA1234X8	FA1000 DOA chamber
FA1234X9	FA1000 R-134A High side service hose
FA1234X10	FA1000 R-134A Low side service hose
FA1234X13	AR2788S II / FA1000 discharge tank hose
FA1234X14	Hybrid hose assembly for R134A
FA1234X16	AR2788S II / FA1000 vacuum pump hose
FA1000X2	DOA out comp suction hose
FA1000X3	Comp discharge DOA HX IN hose
FA1000X4	DOA HX OUT-HV1 tee hose
FA1000X5	DOA oil drain HV3 hose
FA1234X21	FA1000 DOA IN tee (AUX) HS1 purge hose
AR2788SX38	HV1 tank vapor bulk head hose
AR2788SX37	LS1 tank liquid bulk head hose
FA1000X6	HV1 tee HV2 hose
AR2788SX35	HV3 oil drain bulk head hose
FA1000X7	LV3-HV2 tee VAC hose
FA1000X8	LV4 (Regulator) DOA IN tee hose
FA1234X28	AR2788 II / FA1000 four relay PCB
FA1234X29	FA1000 temp. sensor internal tank vapor line
FA1234X30	AR2788 II / FA1000 temp. sensor ambient
FA1234X33	FA1000 key pad
FA1234X34	FA1000 R-134A coupler storage fittings set
FA1234X37	Regulator - 80 PSIG
FA1000X1	Main PCB
FA1234X39	IEC main power inlet
QCH134	R-134A High side coupler
QCL134	R-134A Low side coupler

SERVICE PARTS AND ACCESSORIES

Item	Description
TR21X1	Compressor valve rebuild kit
TR21X2	Compressor complete rebuild kit
TR21X3	Compressor connector rod assembly (2X)
TR21X4	Compressor head assembly with valves
481500	Uview 481500 Oil/Dye Injection Kit

Item	Description
VP6S	6 CFM 50 micron vacuum pump
VPOG	1 gallon vacuum pump oil
VPXF15	Vacuum pump fuse
VPXODP	Vacuum pump oil drain plug
VPXOMP	Vacuum pump exhaust cap