



Custom Seat Cover Installation





Custom Seat Cover



Custom Dash Cover



Custom Car Cover



Custom Floor Mats



Custom Sun Shield



Custom Seat Cover Installation



Buckets

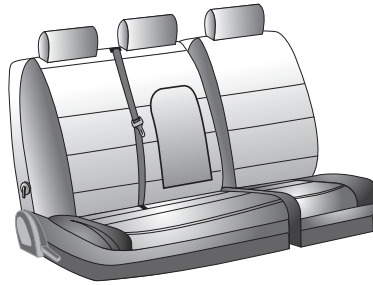

Split Bench
w/ integrated belts

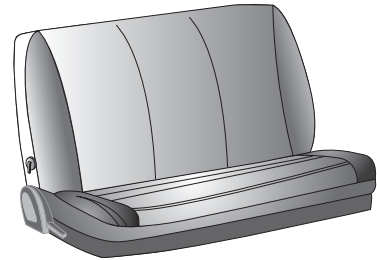

Solid Bench

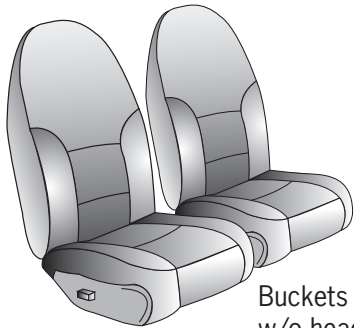

Buckets
w/o headrests

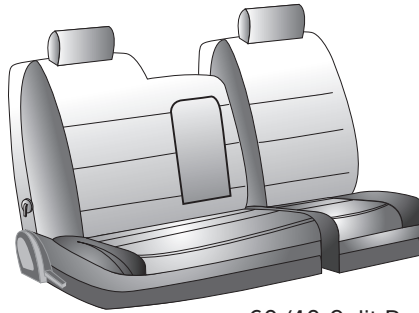

60/40 Split Bench

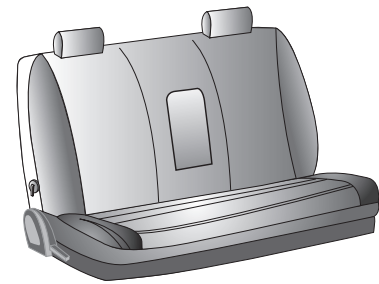

Solid Bench
w/ headrests



Buckets
w/ seatbelts

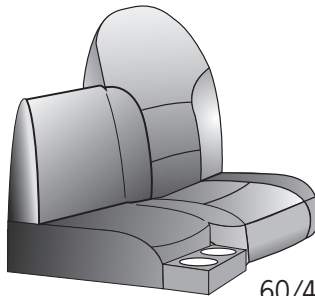

60/40 Split Bench



60/40 Split Bench
w/ integrated belts

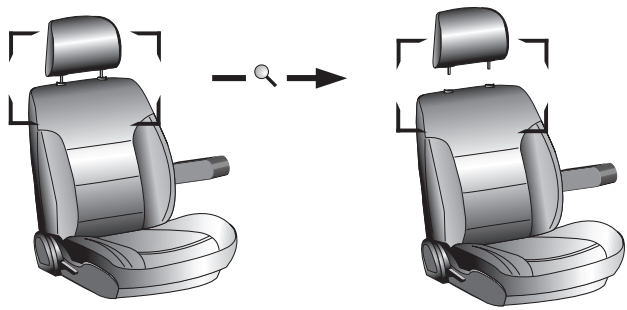

Removing a Headrest

TABs
Depress one or both side tabs while lifting headrest. This may require more than one person.

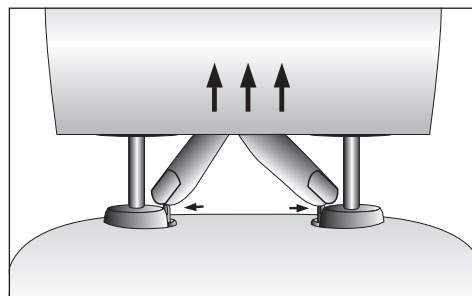
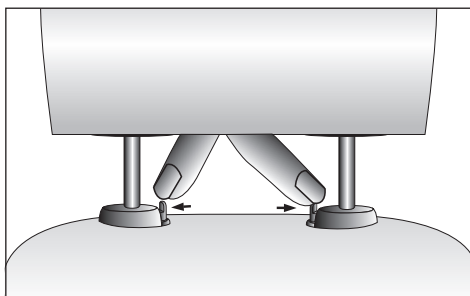
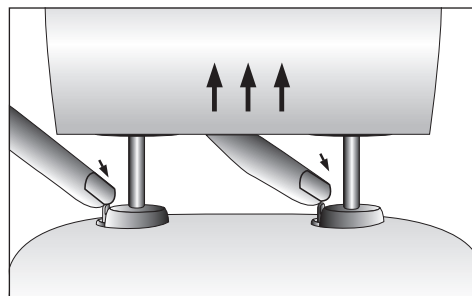
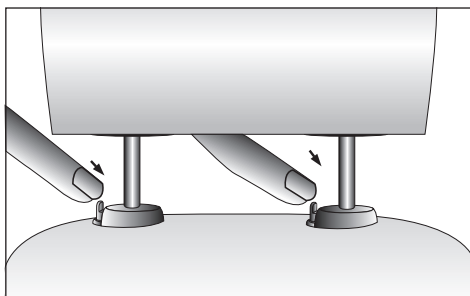
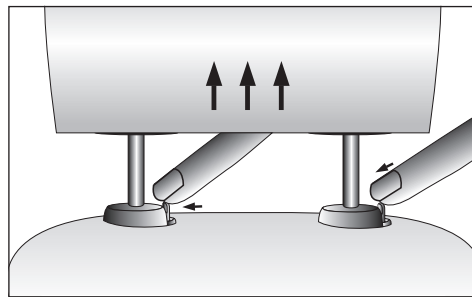
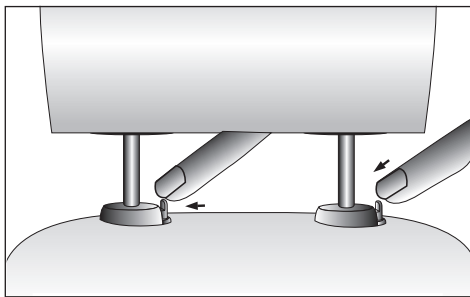
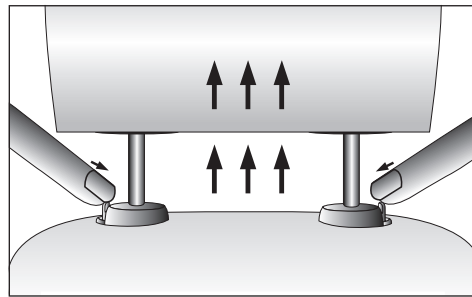
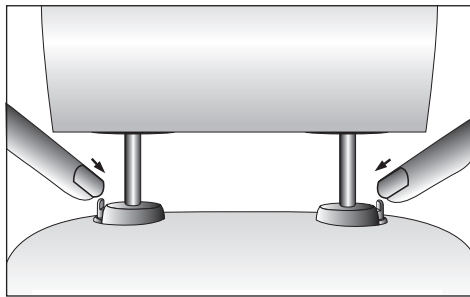

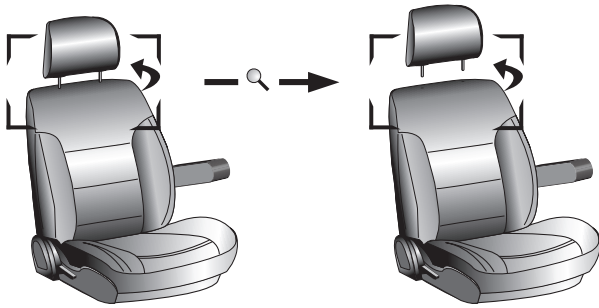

Removing a Headrest

PIN HOLES on Headrest
Insert a paperclip end into the hole on the side of the headrest top.
While pressing the paper clip, lift headrest

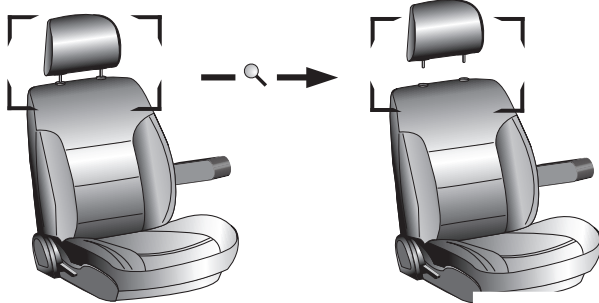
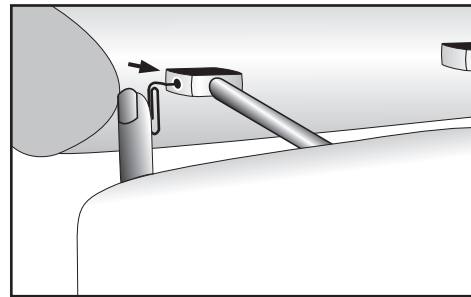
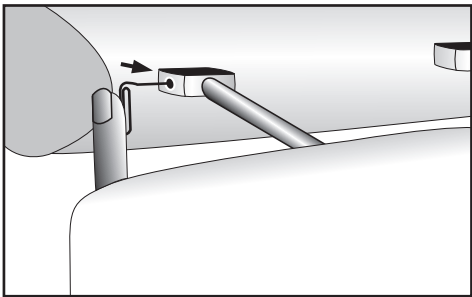

Removing a Headrest

SLOT and TAB
Depress the tab and press into the slot at the same time, and lift headrest. This requires two or more people.

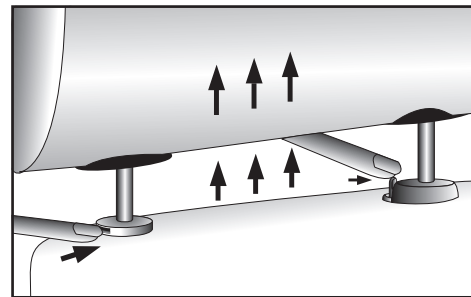
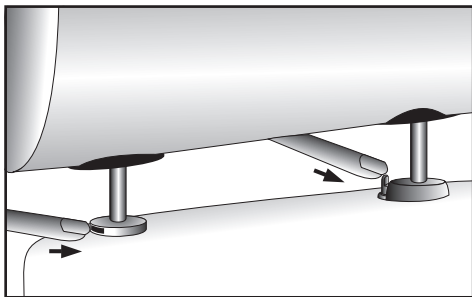

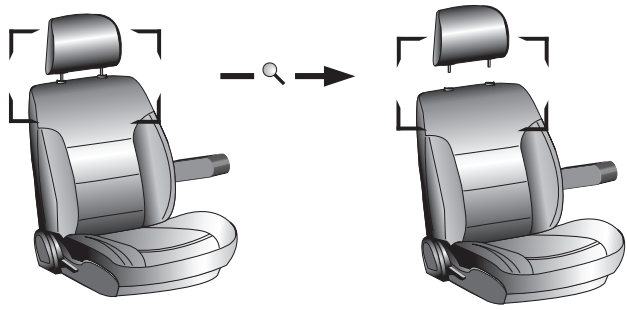

Removing a Headrest

PIN HOLE and TAB

Insert a paperclip end into the hole on the side of the headrest base. While pressing the paper clip, press the tab on the other base. While pressing both, lift the headrest. This requires two or more people.

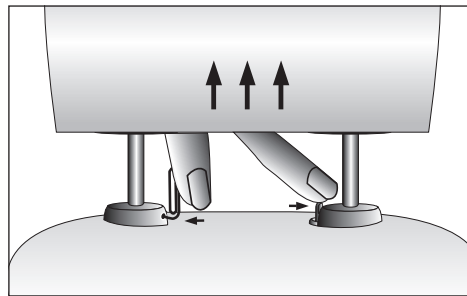
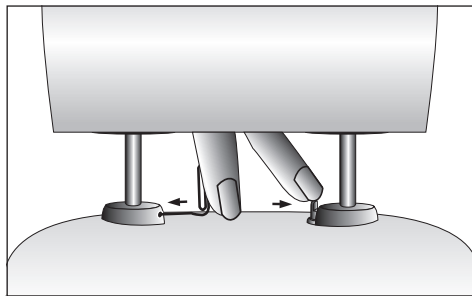
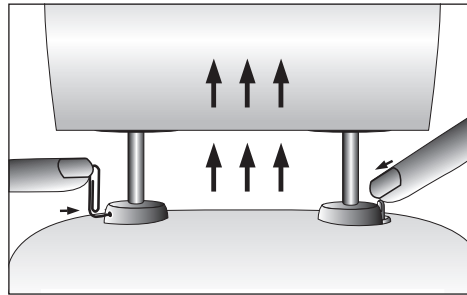
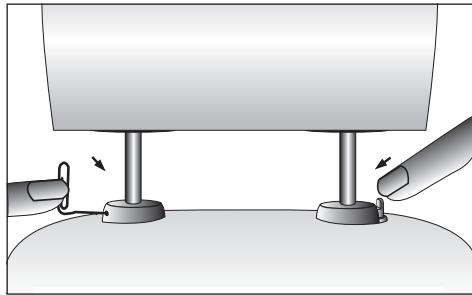



Backrest Cover Installation

Bucket Seats with
Non-Removeable Headrest

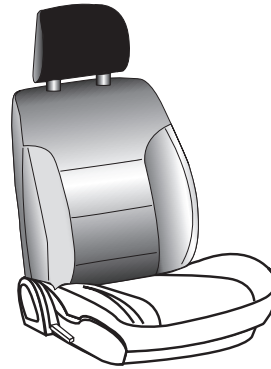
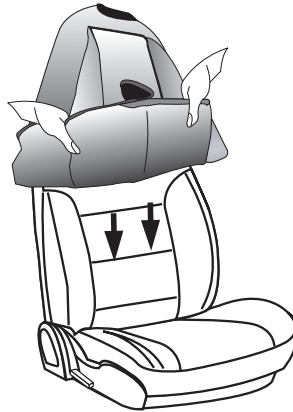
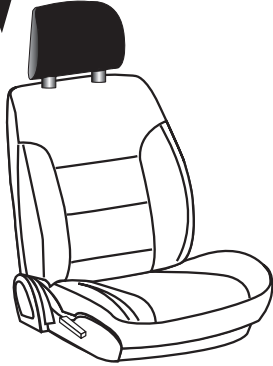
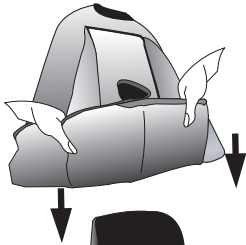

TIP: Fold the seatback forward to gain better access while passing the flap through



Backrest Cover Installation

Certain Seats Required to be
Folded forward for proper installation

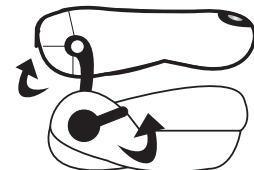
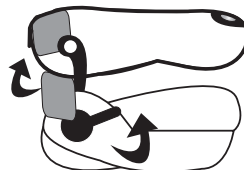
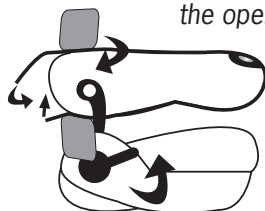
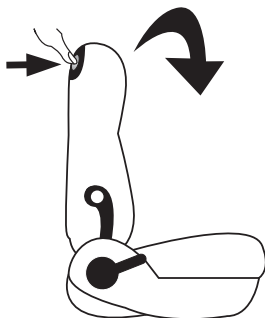
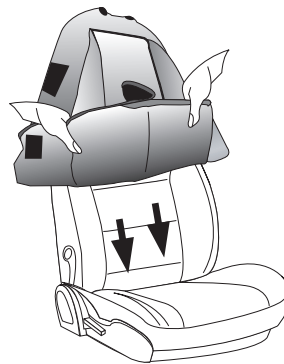
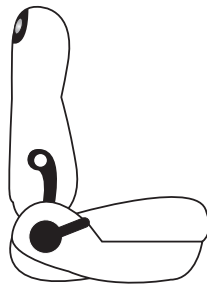
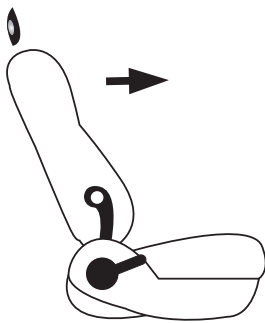

Attach velcro to the flap which is passed through the opening between seatback and seat bottom.



Backrest Cover Installation

Bucket Seats w/ Integrated Seats Belts

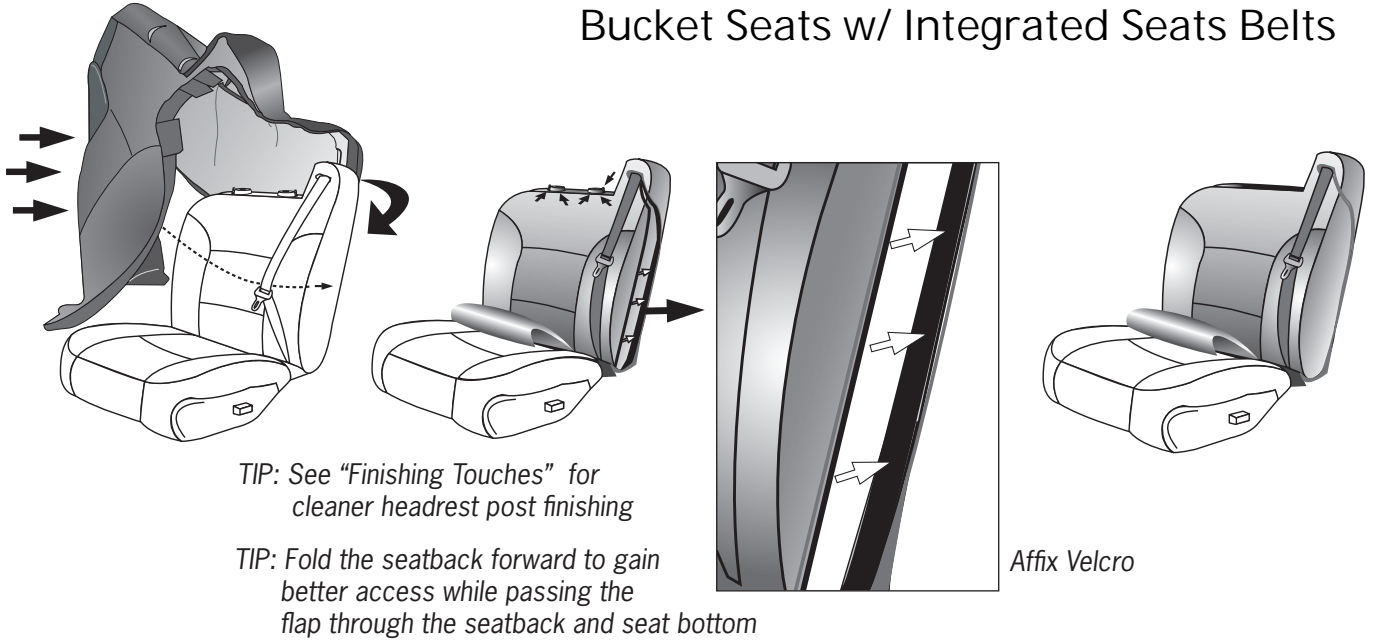

Backrest Cover Installation

High-Back Bucket Seats

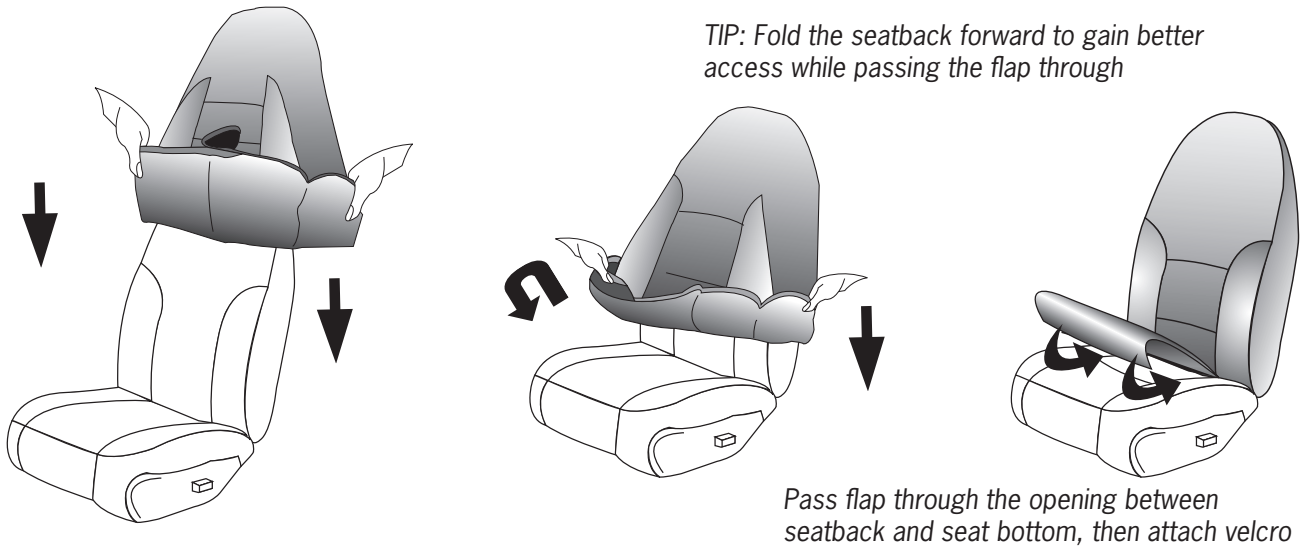



Backrest Cover Installation

60/40 Split Bench

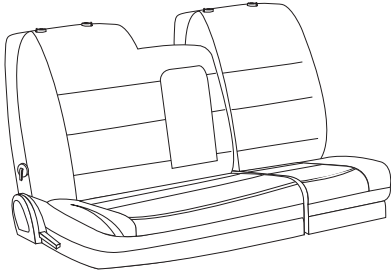

See "Removing a Headrest" section for details on removing headrests.

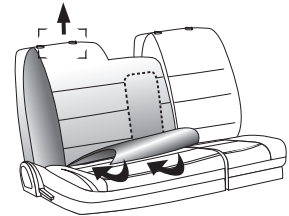
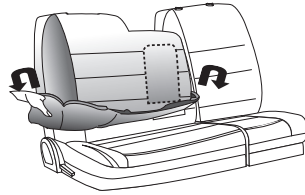
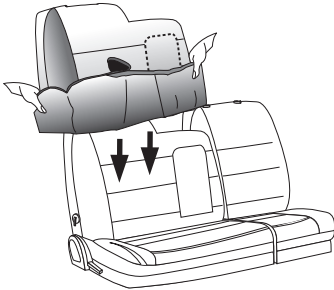

TIP: Fold the seatback forward to gain better access while passing the flap through

Pass flap through the opening between seatback and seat bottom, then attach velcro



Backrest Cover Installation

Special - for older Jeep models

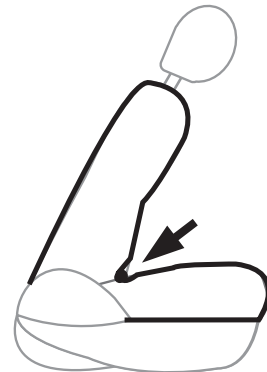
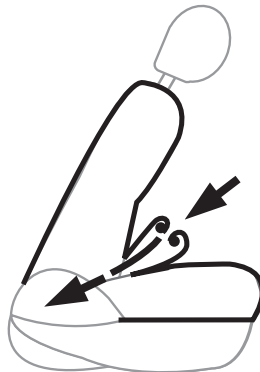

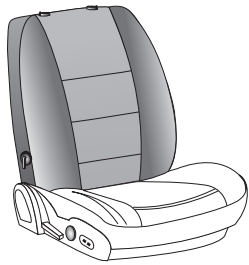

Seat Bottom Cover

TIP: Fold the seatback forward to gain better access while passing the flap through

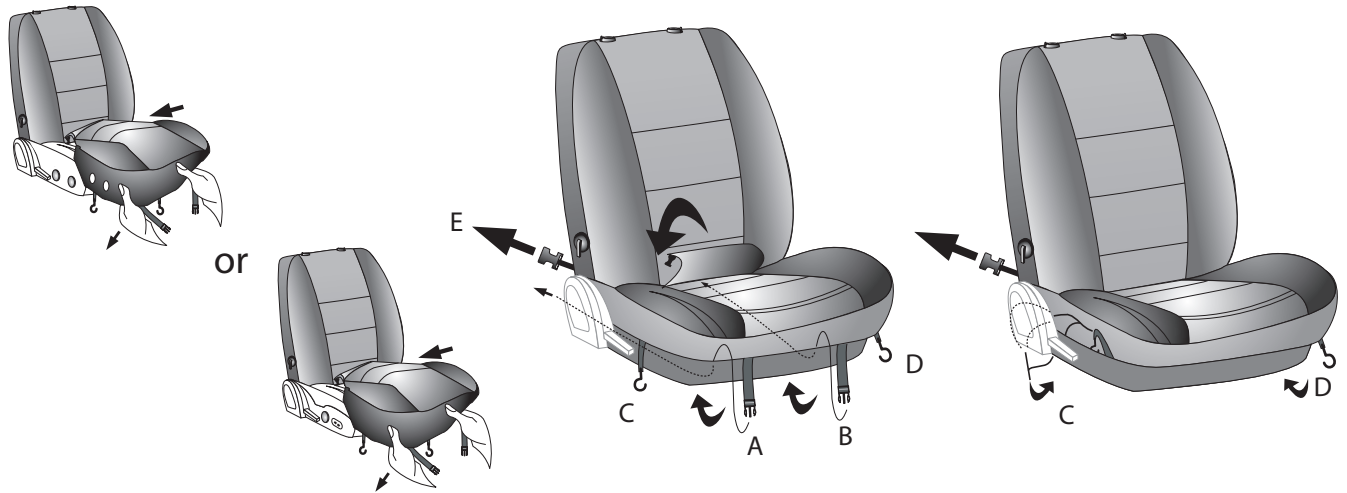

Note: Some seat bases are not covered.

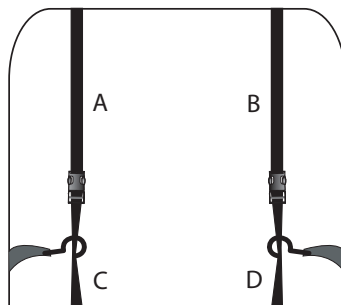
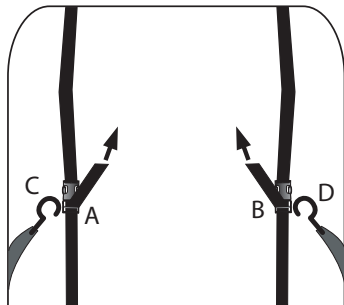
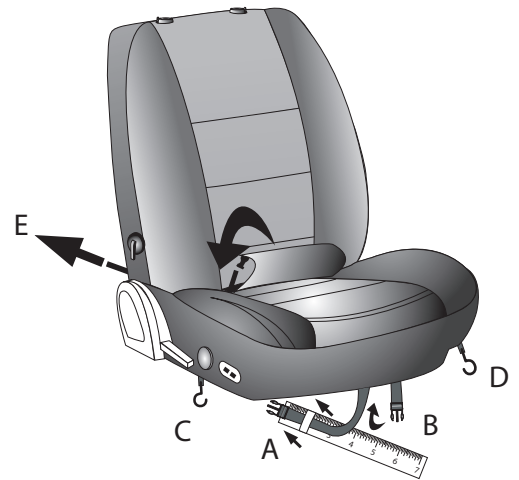
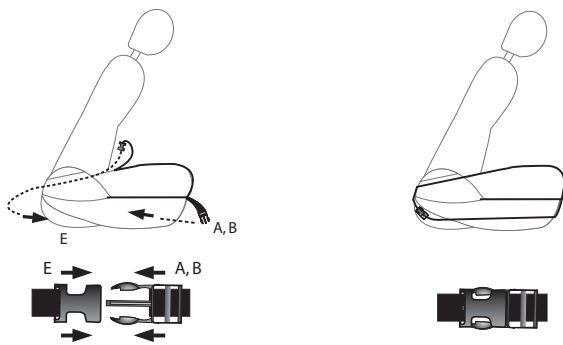

Position cover over seat bottom. Pass flap through and attach buckles and hooks.

TIP: Tuck excess material behind plastic trim pieces for an extra custom look.

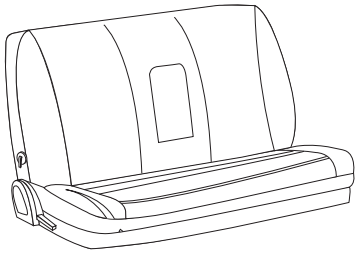

Solid Bench

Follow these simple instructions if you have a solid bench seat (Three people can sit on the seat) (with and without headrests)

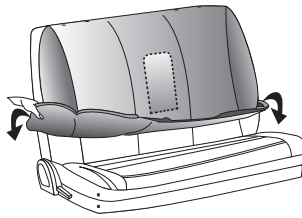
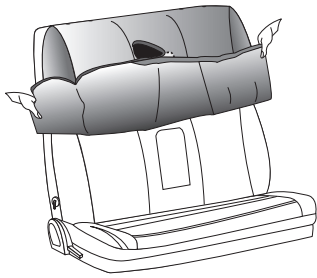

TIP: Fold the seatback forward for easier access

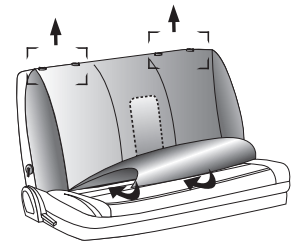

Place backrest cover over backrest. If the seat has a folding armrest, place it in the “up” position. If seat has headrests, remove headrests prior to installation (see “Headrest Removal” instructions)

Tuck flap through the opening between seatback and seat bottom.

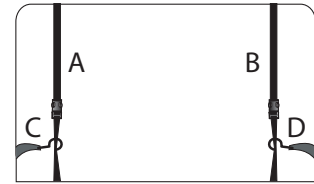
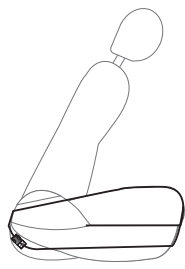
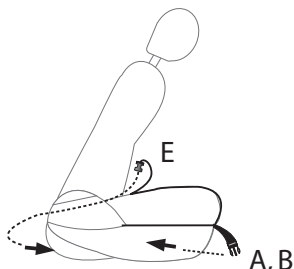
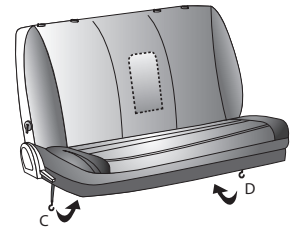
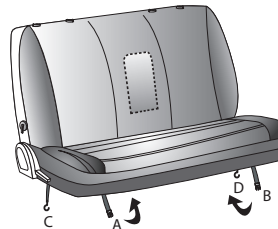
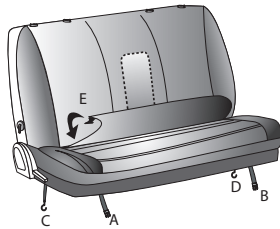
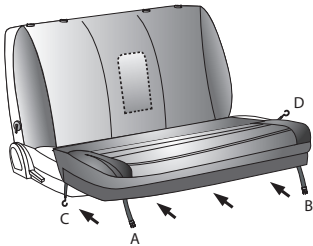

Place seat bottom cover over seat bottom, and affix straps.

See “Finishing Touches” instructions for extra tips



Console Cover Installation

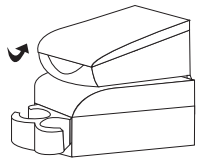
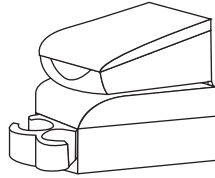

Open Console

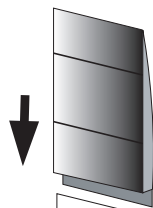

Cover Console top,
then Console bottom.

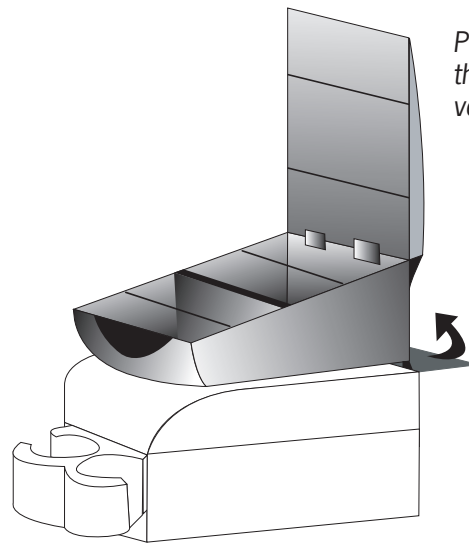
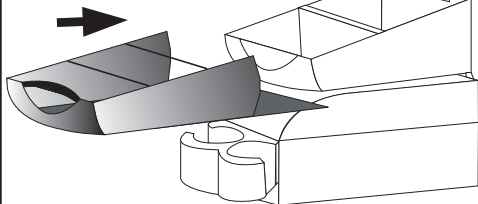

Pass Console bottom flap
through opening, then affix
velcro.

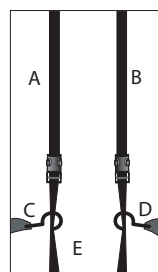
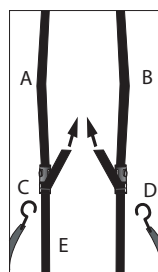
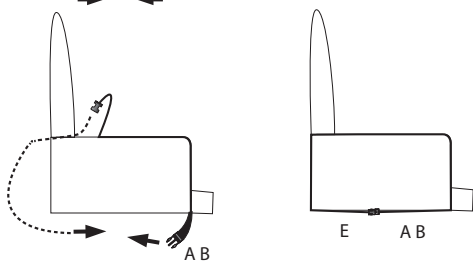
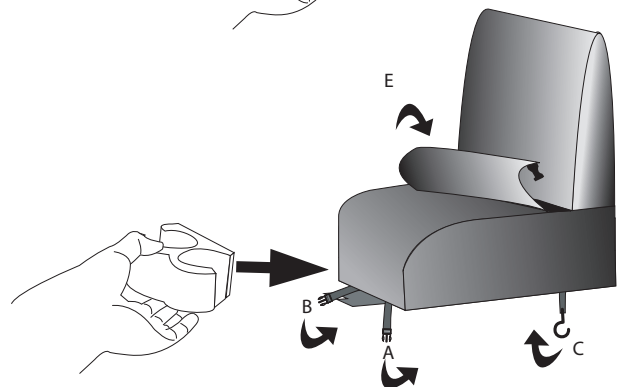
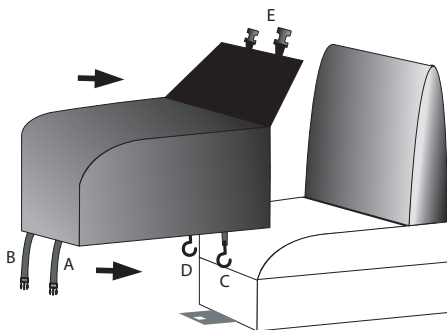
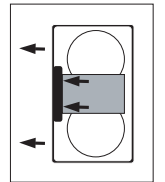
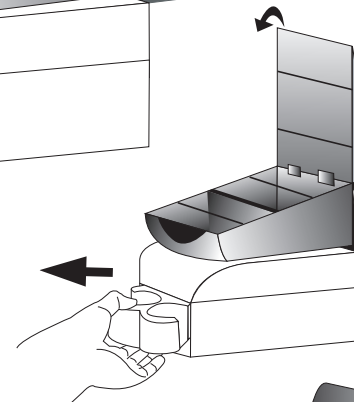



Special Instructions - 1

Seats with Airbags, Lumbar Supports and Armrests require special instructions:



A

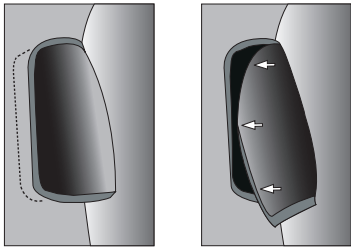

Seats with Integrated Seat Airbags must be covered only with seat covers designed with opening flaps. The flap inserts inside the cutout, and should be able to open freely in case of deployment.

If your vehicle has seat mounted airbags, be certain that the seat covers have airbag cutouts or flaps! **DO NOT COVER SEAT AIRBAGS**

B

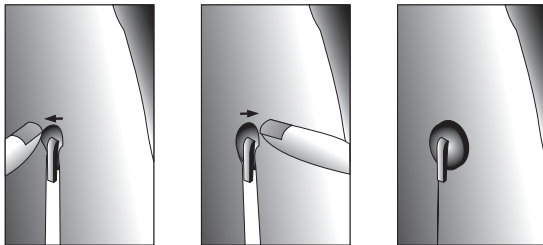

Some levers or controls may require a slit in the seat cover.

C

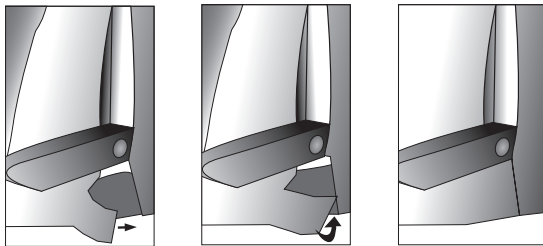

Installing backrest cover around armrests.

D

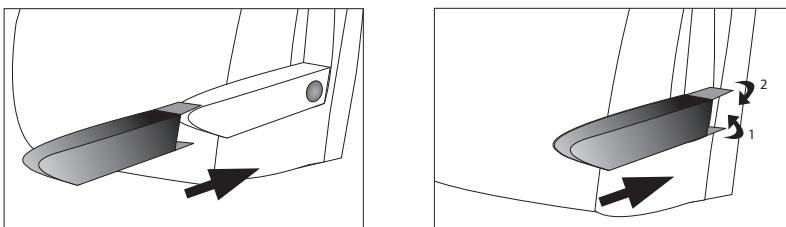

Installing armrest covers, affixing velcro.

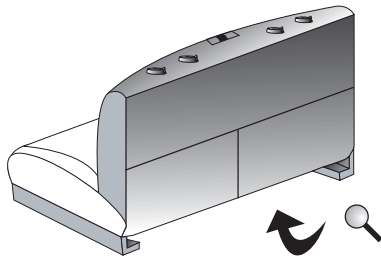
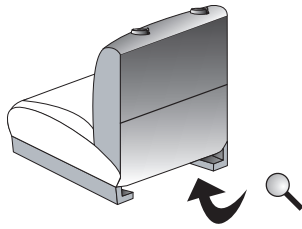

Special Instructions - 2

Certain Late-Model vehicles, including Lexus, Toyota, Infiniti, Nissan Hyundai and others have a piece of fabric which prevents the seat cover flap from going through the opening of the seatback and seat bottom.

This flap will need to be removed to install the seat cover. Below are instructions detailing the methods used to remove this fabric



The views shown below are looking at the bottom of the seat

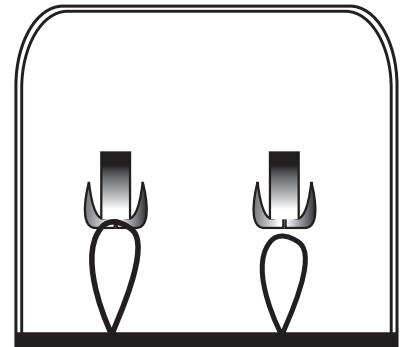
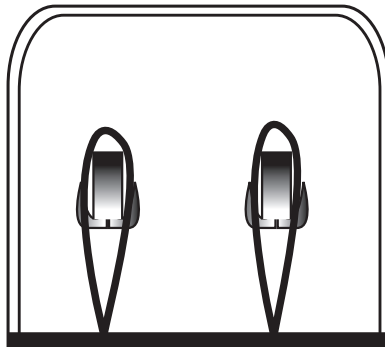
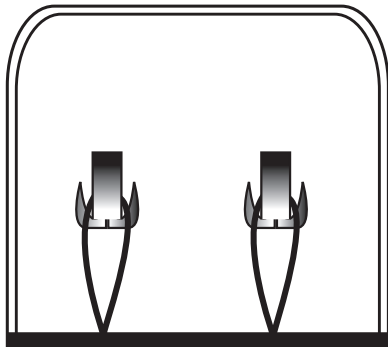

CONDITION 1 - An elastic strap holds the flap of fabric to some permanently mounted hooks. To remove, simply pull the elastic forward and remove the elastic loop from the hook.

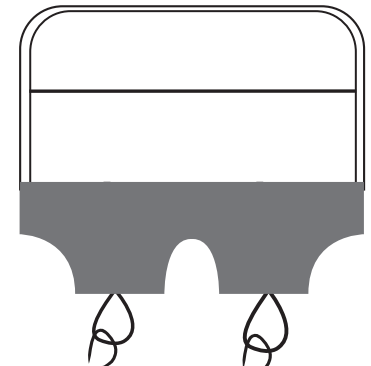
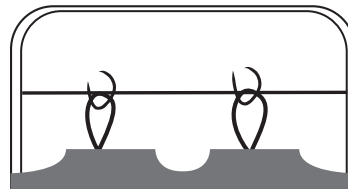
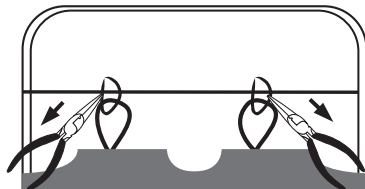

Pliers required

CONDITION 2 - Metal hoops hold the flap of fabric to a steel support under the seat. To remove, use a set of pliers to open the hoop, and remove the fabric.

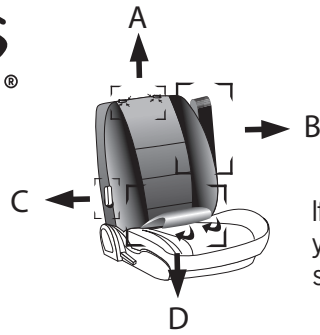

Finishing Touches

If you have extra time and a little mechanical inclination, your seat covers can fit even better by following these simple finishing touches:

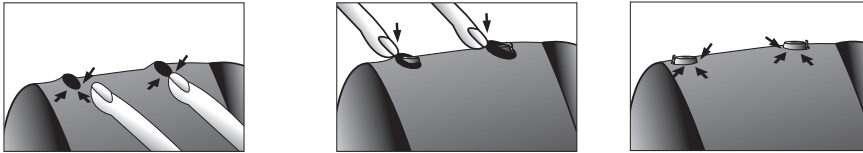
A

Material around the headrest posts can be stretched over the base and tucked underneath.

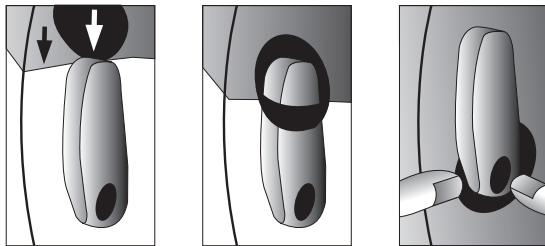
B

Adjust material around armrests by tucking excessive material around the base.

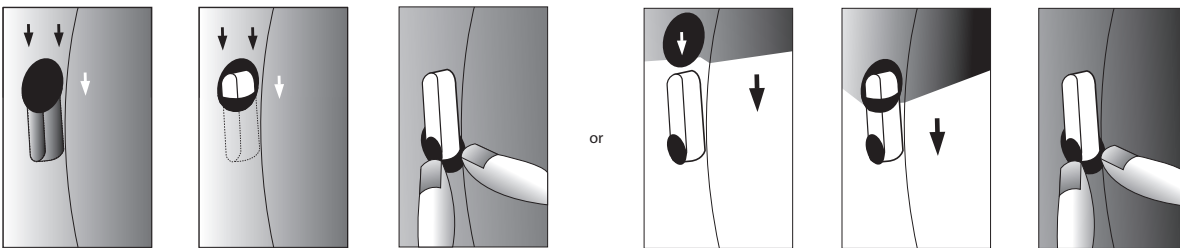
C

Pay special attention to small levers, such as lumbar support. Material should be tucked under the lever.

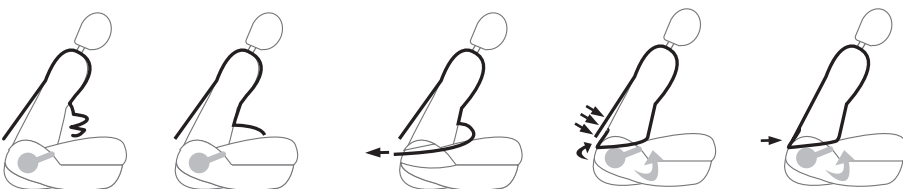
D

TIP: Fold the seatback forward for easier access

After the first two weeks of use, tighten the seat back covers by releasing them, and - using the assistance of another person - pull the material very tight, and affix the Velcro fastener.