

# CLASSIC TUBE®

BENT ON PERFECTION™

- **Stainless and OE Pre-Bent-Tubing**
- **StopFlex® Stainless Braided Brake Hoses**
- **Exhaust Tube Parts**
- **Disc Brake Conversion Kits**
- **DIY Coils, Fittings and Tools**



# The Classic Tube Story

Classic Tube is celebrating over 27 years of service to the Automotive Aftermarket.

Founded in 1989 by Paul and Lauren Fix, we saw a void in the classic car restoration market for preformed tubing products. The product lines included replacement tubing for brake, fuel, transmission and carburetor applications. The request for tubing grew and soon we had built a catalog of thousands of patterns that spanned from the 1930s to the present – for Cars and Trucks both Domestic and Foreign.

As more product lines developed, we added the Do It Yourself materials and tools for customers to fabricate tubing themselves.

Classic Tube also developed the StopFlex product line of D.O.T. Stainless Steel Braided Brake Hoses. These are manufactured as direct replacement brake hoses with factory ends and attaching brackets.

Today, Classic Tube has the largest and most complete inventory of original replacement tubes. We continue to be the primary source for the restoration market and are constantly developing new product lines to satisfy our customers' needs. Serving the classic car industry has given Classic Tube the privilege of supplying products to some of the most renowned restorers and collectors worldwide.



Our large dealer network and direct sales provide our customers with the product they expect.

To achieve results that surpass industry standards, we utilize computerized tube bending equipment along with CMM scanning. With this practice, we can produce a higher quality product that is cost effective and delivered in a timely manner.

Classic Tube is a respected leader in preformed tubing products and serve customers in Automotive, Medical, Heavy Equipment, Military and Aerospace Industries. Utilizing the most current technology maintains superior quality control. Our mission is to provide a great customer experience.

Our commitment to exceptional quality and outstanding customer service is reflected in 27 years of satisfied customers. As a mark of our high standards, our products are made in our facility in Lancaster, NY, using all USA materials. Classic Tube has **always** been proud to say "Made in the USA."

## Classic Tube's Commitment to Quality

Our products are made to last. We achieve our superior quality by using the best, USA-sourced materials and by employing strict quality control standards. All of our tubing is manufactured with computer controlled precision, on our state-of-the-art computerized CNC programmable tube benders, insuring exact duplication to OEM specifications. All lines are perfectly end formed using fully automatic hydraulic end forming machines. Custom tooling is available for your special application, call with your needs.

## We Love Our Customers

We take great pride in helping our customers outfit their daily rides and prized collectibles with high quality, made-to-last parts. We've also learned over the years that our customers are great people and we love to meet them face-to-face. We exhibit at several car shows and automotive events each year – follow us on social media to find out where we'll be and when.



# CONTENTS

## PREBENT

<b>Domestics</b>	
Buick .....	2
Cadillac.....	10
Chevrolet .....	11
Chevy/GMC Truck.....	26
Chrysler .....	36
Dodge .....	38
Plymouth .....	50
Ford .....	61
Ford Truck .....	70
Shelby.....	74
Lincoln.....	75
Mercury .....	76
Jeep .....	78
Oldsmobile .....	80
Pontiac.....	84
<b>Misc. Domestics.....</b>	<b>92</b>
AMC, DeLorean, GEO, Hudson, International, Kaiser, LaSalle, Nash, Packard, Studebaker	
<b>Imports .....</b>	<b>94</b>
AC, Alfa Romeo, Allard, Aston Martin, Austin Healey, BMW, Datsun, DeTomaso, Ferrari, Fiat, Griffith, Hillman, Honda, Hummer, Jaguar, Jensen Healey, Lamborghini, Land Rover, Lotus, Mercedes, MG, Mini, Mitsubishi, Morgan, Nissan, Porsche, Sunbeam, Toyota, Triumph, Volkswagen, Volvo	

## BULK TUBING/FITTINGS

Straight Length Tubing .....	102
Coil Tubing.....	102
Fittings, Clamps, Brackets.....	103

## ACCESSORIES/TOOLS .....

### STOPFLEX®

<b>Stainless Steel Braided Brake Hoses</b>	
StopFlex® Kits .....	107
StopFlex® Pre-Cut Lengths .....	115
StopFlex® Fittings .....	116

## EXHAUST TUBES .....

## DISC BRAKE CONVERSION KITS.....

# BUICK

## BUICK EARLY & MISC.

### Complete Brake Line Kit

Part No.	Year	Description	Buick Early & Misc.	
			O.E. Steel	Stainless Steel
BU1039	1936	Special		
BU1001	1939	Special		
BU1002	1940	Special Model 46S Brake Line Kit		
BU1044	1940	81C Limited Brake Line Kit		
BU1045	1940	Super Model 51 Brake Line Kit		
BU1003	1941-42	Super		
BU1030	1941-42	Special		
BU1008	1946-48	Super		
BU1004	1950-52	Super		
BU1004	1950-52	Estate		
BU1005	1953	Super		
BU1005	1953	Estate		
BU1006	1954	Super		
BU1006	1954	Roadmaster		
BU1059	1954	Special Brake Line Kit		
BU1021	1955	Special Brake Line Kit		
BU1007	1956	Special w/ Power Brakes		
BU1007	1956	Century w/ Power Brakes		
BU1060	1956	Special Standard Brake		
BU1052	1957	Roadmaster & Super Power Brake		
BU1061	1957	Century & Special Power Brake		
BU1015	1958	Special Power Brake		
BU1038	1958	Super Power Brake		
BU1062	1958	Super Standard Brake		
BU1063	1958	Super		
BU1025	1961	Invicta		
BU1023	1965	Electra		
BU1023	1965	Wildcat		
BU1046	1975	Apollo Standard Disc		
OL1031	1976-84	Estate Wagon Power Disc		
BU1067	1997-99	Park Avenue Without Traction Control		

### Caliper Inlet Lines & Transfer Tubes (Sold in Pairs)

Part No.	Year	Description	Buick Early & Misc.	
			O.E. Steel	Stainless Steel
CUD1001	1967	Skylark/GS/Special Disc (Inlet 3/8" and 3/8")		
GLD1001	1967	Skylark/GS/Special Disc (Inlet 7/16" and 1/2")		
GLD1003	1968	Skylark/GS/Special Disc (Inlet 7/16" and 1/2")		

### Fuel - Pump To Carburetor Line

Part No.	Year	Description	Buick Early & Misc.	
			O.E. Steel	Stainless Steel
BUC1015	1940	Super Stromberg Carburetor		
BUC1022	1940	Super Carter Carburetor		
BUC1012	1953	Super 322 CID - 2 Barrel		
BUC1009	1967	All Models 300 CID 2 Barrel		

### Fuel - Tank To Pump Line

Part No.	Year	Description	Buick Early & Misc.	
			O.E. Steel	Stainless Steel
BUF1026	1936	All Models 5/16"		
BUF1031	1940	81 C W/ Stromberg Carburetor - (3 pc.)		
BUF1001	1941	Super Straight 8 - 5/16"		
BUF1002	1950	Super		
BUF1016	1952	Wagon		
BUF1003	1953	Super Convertible		
BUF1010	1955	All Models (3 Pc.)		
BUF1005	1956	All Models (3 Pc.)		
BUF1008	1974	Apollo (2 Pc.)		
BUF1028	1988	Reatta		

### Fuel - Return Line

Part No.	Year	Description	Buick Early & Misc.	
			O.E. Steel	Stainless Steel
BUR1006	1952	Wagon		
BUR1014	1988	Reatta Return Line		

### Fuel - Vapor Line

Part No.	Year	Description	Buick Early & Misc.	
			O.E. Steel	Stainless Steel
BUV1001	1974	Apollo 5/16"		

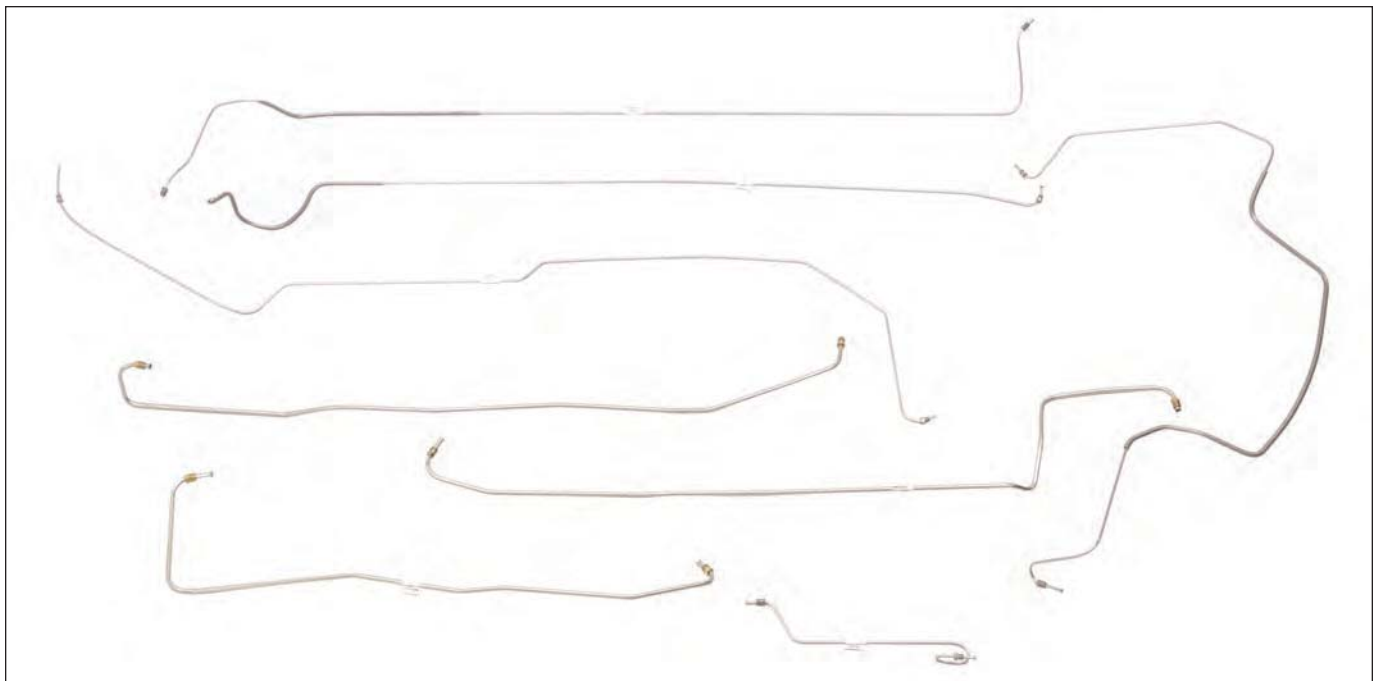

## BUICK

Transmission Lines (Sold In Pairs)			Buick Early & Misc.	
Part No.	Year	Description	O.E. Steel	Stainless Steel
BUT1001	1956	Special		
BUT1003	1960	Invicta		

Miscellaneous & Other Lines			Buick Early & Misc.	
Part No.	Year	Description	O.E. Steel	Stainless Steel
BUO1043	1940	81C Limited Oil Line - (2 Pc.)		
BUO1044	1940	81C Limited Vacuum Line (2 Pc.)		
BUO1046	1940	Model 51 Engine Lines - Intake manifold to Vacuum pump on fuel pump		
BUO1047	1940	Model 51 Engine Lines - Oil filter to Oil Galley on Block		
BUO1048	1940	Model 51 Engine Lines - Front of Head to Bottom Oil Filter		
BUO1049	1940	Model 51 Engine Lines - Vacuum pump on Fuel pump		
BUO1054	1940	76C Oil Filter Line		
BUO1055	1940	Model 76C Pump to Intake Line		
BUO1056	1940	Model 76C Pump to Wiper Line		
BUO1060	1940	40-76C Oil Filter Line		
BUO1061	1940	40-76C Stromberg Carburetor - Pump to Intake Line		
BUO1063	1940	Model 51 Intake Manifold to Vacuum Pump on Fuel Pump - Carter Carburetor		
BUO1001	1941	Super Straight 8 Oil Line (2 Pc.) 1 is 3/16" and 1 is 1/8"		
BUO1025	1949	All Models Convertible - Top Lines		
BUO1002	1953	Super Convertible - Hydraulic Power Window & Top (10 Pc.)		
BUO1003	1954	Special Hydraulic Power Window Lines		
BUO1003	1954	Super Hydraulic Power Window Lines		
BUO1050	1954	Special Convertible Top Lines		
BUO1050	1954	Super Convertible Top Lines		
BUO1057	1955	All Models Booster Line		

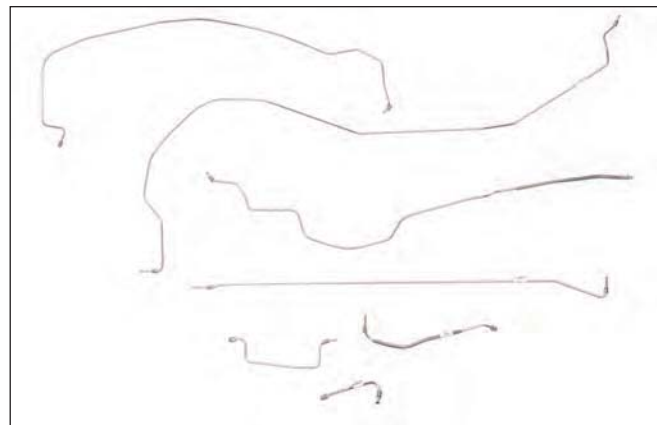

Fuel - Vapor Line			Century	
Part No.	Year	Description	O.E. Steel	Stainless Steel
BUV1007	2000-05	3.8 Liter V6		

Fuel - Miscellaneous			Century	
Part No.	Year	Description	O.E. Steel	Stainless Steel
POF1027	1997-99	V6 F.I. Feed Line		

Transmission Lines (Sold In Pairs)			Century	
Part No.	Year	Description	O.E. Steel	Stainless Steel
BUM1003	1955			
BUT1002	1958	Dyna Flow		

Miscellaneous & Other Lines			Century	
Part No.	Year	Description	O.E. Steel	Stainless Steel
BUO1003	1954	Hydraulic Power Window Lines		
BUO1005	1954	Brake Booster Vacuum Line		
BUO1050	1954	Convertible Top Lines		
BUO1017	1955	Pump to Manifold Vacuum Lines (2 Pc.)		
BUO1018	1955	Booster Vacuum Set (5 Pc.) 4 are 3/8" and 1 is 1/2"		
BUO1019	1955	Oil Supply Line - 1/8"		
BUO1045	1955	Engine Vacuum Line		
BUO1009	1958	Vacuum Line Set (3 Pc.)		

## CENTURY

Complete Brake Line Kit			Century	
Part No.	Year	Description	O.E. Steel	Stainless Steel
BU1054	1937			
BU1034	1940	Convertible		
BU1059	1954	Brake Line Kit		
BU1021	1955	Brake Line Kit (5 Pc.)		
BU1007	1956	Power Brake		
BU1060	1956	Standard Brake		
BU1061	1957	Power Brake		
BU1015	1958	Power Brake		
BU1063	1958	Standard Brake		
BU1053	1997-01	With ABS - Rear Disc		
BU1066	1997-03	With ABS - Rear Drum		

Fuel - Pump To Carburetor Line			Century	
Part No.	Year	Description	O.E. Steel	Stainless Steel
BUC1011	1955			

Fuel - Tank To Pump Line			Century	
Part No.	Year	Description	O.E. Steel	Stainless Steel
BUF1023	1940	Convertible		
BUF1009	1955	(3 Pc.) - 5/16"		
BUF1012	1955	Front & Side (2 Pc.)		
BUF1033	1985	T-Type - 231 CID - V6 - Front Wheel Drive		
BUF1037	2000-05	3.8 Liter V6		

Fuel - Return Line			Century	
Part No.	Year	Description	O.E. Steel	Stainless Steel
BUR1016	1985	T-Type - 231 CID - V6 - Front Wheel Drive		
POR1008	1997-99	V6		
BUR1019	2000-05	3.8 Liter V6		

## ELECTRA

Complete Brake Line Kit			Electra	
Part No.	Year	Description	O.E. Steel	Stainless Steel
BU1063	1958	Power Brakes		
BU1018	1959	Standard Brake		
BU1009	1960	Power Brake (7 Pc.)		
BU1064	1960	Standard Brakes		
BU1017	1961	Standard Brake		
BU1025	1961	Power Brake		
BU1024	1963	Power Drum		
BU1023	1965	Electra		
WI1007	1966	Power Drum		
BU1031	1967	Power Drum Brakes		
WI1002	1969	Hardtop - Power Drum		

Fuel - Pump To Carburetor Line			Electra	
Part No.	Year	Description	O.E. Steel	Stainless Steel
SGC1005	1970-72	455 CID - Quadrajel Carburetor - Non Air Conditioning		

Fuel - Tank To Pump Line			Electra	
Part No.	Year	Description	O.E. Steel	Stainless Steel
BUF1014	1963			
BUF1021	1967	3/8"		

# BUICK

Fuel - Return Line			Electra	
Part No.	Year	Description	O.E. Steel	Stainless Steel
BUR1008	1967			

Transmission Lines (Sold In Pairs)			Electra	
Part No.	Year	Description	O.E. Steel	Stainless Steel
BUT1022	1959			
BUT1013	1965	Super Turbine 400 - No A/C		
BUT1016	1967	T-400 430 CID		

## GRAND NATIONAL

Complete Brake Line Kit			Grand National	
Part No.	Year	Description	O.E. Steel	Stainless Steel
BU1028	1985-87	Power Disc		

Fuel - Pump To Carburetor Line			Grand National	
Part No.	Year	Description	O.E. Steel	Stainless Steel
BUC1014	1982-83			

Fuel - Tank To Pump Line			Grand National	
Part No.	Year	Description	O.E. Steel	Stainless Steel
BUF1025	1982-83	With Carburetor and Turbo		
BUF1015	1984-85	(1 Pc.)		
BUF1013	1986-87	With Inline Filter (2 Pc.)		

Fuel - Return Line			Grand National	
Part No.	Year	Description	O.E. Steel	Stainless Steel
BUR1013	1982-83	With Carburetor and Turbo		
BUR1005	1984	(1 Pc.)		
BUR1011	1984-85	(1 Pc.)		
BUR1015	1984-85	Fuel - Rail Return Line		
BUR1012	1986-87	Fuel - Rail Return Line		

Fuel - Vapor Line			Grand National	
Part No.	Year	Description	O.E. Steel	Stainless Steel
BUV1003	1984-87	(1 Pc.)		

Fuel - Stand Pipe Set			Grand National	
Part No.	Year	Description	O.E. Steel	Stainless Steel
BUS1001	1984-87	(3 Pc.)		

Fuel - Miscellaneous			Grand National	
Part No.	Year	Description	O.E. Steel	Stainless Steel
BUF1029	1984	Fuel - Rail Feed Line		
BUF1030	1984	Feed to Filter		
BUC1007	1984-85	Fuel - Miscellaneous - Throttle Body Injection		
BUF1024	1986-87	Fuel - Rail Feed Line (1986-87)		

Transmission Lines (Sold In Pairs)			Grand National	
Part No.	Year	Description	O.E. Steel	Stainless Steel
BUT1011	1984-85	(4 Pc.)		
BUT1012	1986-87	(4 Pc.)		

Miscellaneous & Other Lines			Grand National	
Part No.	Year	Description	O.E. Steel	Stainless Steel
BUM1006	1982	Turbo to Transmission Modulator Line		
BU01035	1982	Vacuum Set (3 Pc.)		
BU01036	1982	Turbo to Transmission Modulator Line		
BU01037	1982	Turbo Oil Feed Line (1 Pc.)		
BU01038	1984	Throttle Body Coolant Line - 1/4"		
BU01039	1984	Power Steering Pump to Hydroboost		
BU01040	1984	Power Steering Booster to Gear Box		
BU01041	1984	Power Steering Return Line		
BU01027	1984-85	Turbo Oil Line (2 Pc.)		
BU01013	1986-87	Engine Emission Tubes (5 Pc.)		
BU01014	1986-87	T-Type Engine to Turbo Oil Line		
BU01042	1986-87	High Pressure Power Steering Line		
BU01062	1986-87	3.8 Liter Turbo - Oil Cooler Hose Set		
BU01034	1987	Power Steering Line		

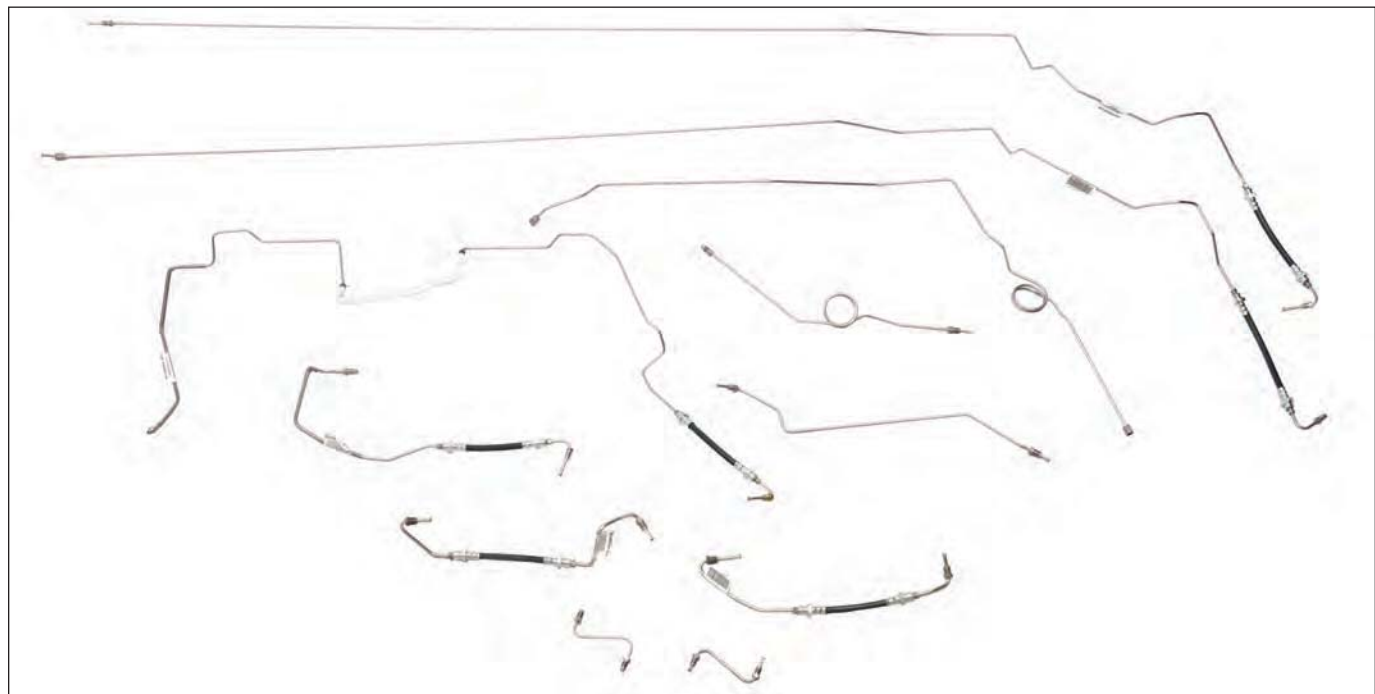

# BUICK

## LeSABRE

### Complete Brake Line Set

Part No.	Year	Description	O.E. Steel	Stainless Steel
BU1032	1963	Convertible		
BU1043	1966	1966		
BU1065	1967-68	Power Drum Brakes		
BU1013	1969	Power Brake		
IB1038	1971-73	Hardtop - Power Disc		
IB1040	1971-73	Convertible - Power Disc		
IB1061	1974-76	Convertible Power Disc		
BU1014	1974-77	Power Disc		
BU1049	1994-95	Brake Line Kit		
BU1042	1996	Park Avenue W/ Traction control		
BU1058	1996	Park Avenue Without Traction control		
BU1048	1996-99	Without Traction control		
BU1051	1996-99	With Traction Control		

### Caliper Inlet Lines & Transfer Tubes (Sold in Pairs)

Part No.	Year	Description	O.E. Steel	Stainless Steel
BUD1001	1970	Caliper Inlet Lines		
BUD1003	1996-99	Rear Inlet Lines		

### Fuel - Pump To Carburetor Line

Part No.	Year	Description	O.E. Steel	Stainless Steel
BUC1004	1974	350 CID 2 Barrel		

### Fuel - Tank To Pump Line

Part No.	Year	Description	O.E. Steel	Stainless Steel
BUF1027	1940			
BUF1035	1997			

### Fuel - Return Line

Part No.	Year	Description	O.E. Steel	Stainless Steel
BUR1018	1996-99			

### Fuel - Vapor Line

Part No.	Year	Description	O.E. Steel	Stainless Steel
BUV1006	1997			

### Transmission Lines (Sold In Pairs)

Part No.	Year	Description	O.E. Steel	Stainless Steel
BUT1007	1970	T-350		
SGM1002	1970-74	T-350		
BUT1006	1974	T-350		

### Miscellaneous & Other Lines

Part No.	Year	Description	O.E. Steel	Stainless Steel
BUO1026	1974	Power Steering Return		

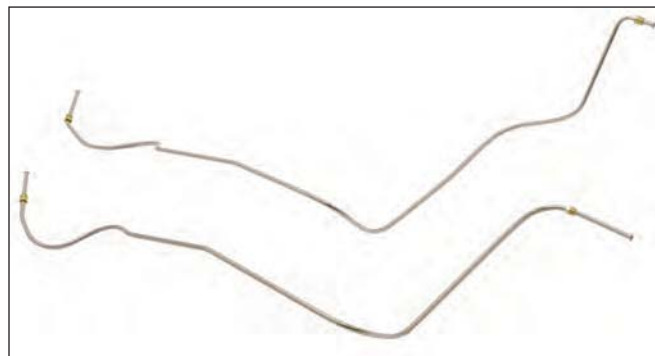

## REGAL

### Complete Brake Line Kit

Part No.	Year	Description	O.E. Steel	Stainless Steel
CE1054	1978-81	Power Disc		
BU1029	1982-87	Power Disc		
CU1046	1988-93	Non - ABS		
BU1047	1988-94	With ABS		

### Fuel - Pump To Carburetor Line

Part No.	Year	Description	O.E. Steel	Stainless Steel
BUC1010	1976	350 CID 4 Barrel		

### Fuel - Tank To Pump Line

Part No.	Year	Description	O.E. Steel	Stainless Steel
BUF1019	1973-77			
BUF1034	1992	4 Door - 3800 FI - (2 Pc.)		
BUF1037	2000-05	3.8 Liter V6		

### Fuel - Return Line

Part No.	Year	Description	O.E. Steel	Stainless Steel
BUR1009	1973-77			
BUR1017	1992	4 Door - 3800 FI		
POR1008	1997-99	V6		
CUR1010	1988-91	3.1 Liter		
BUR1019	2000-05	3.8 Liter V6		

### Fuel - Vapor Line

Part No.	Year	Description	O.E. Steel	Stainless Steel
BUV1004	1973-77			
BUV1005	1978-88	With A/C Only		
MCV1002	1978-88	Without AC		
BUV1007	2000-05	3.8 Liter V6		



# BUICK

Fuel - Stand Pipe Set			Regal
Part No.	Year	Description	O.E. Steel Stainless Steel
BUS1001	1978-87	(3 Pc.) Non-Turbo	
BUS1002	1988-91	GS Fuel Injected (3 Pc.)	

Fuel - Miscellaneous			Regal
Part No.	Year	Description	O.E. Steel Stainless Steel
POF1027	1997-99	V6 F.I. Feed Line	

Transmission Lines (Sold In Pairs)			Regal
Part No.	Year	Description	O.E. Steel Stainless Steel
BUT1014	1976	V8 - T-350	
BUT1015	1979-82	6 Cylinder	
GPT1006	1990-94	3.1 V6 4T60E Transmission	

Miscellaneous & Other Lines			Regal
Part No.	Year	Description	O.E. Steel Stainless Steel
BUO1058	1978-80	Turbo Oil Cooler Line	
BUO1022	1980-83	Turbo Oil Line - 1/4"	
BUO1027	1984-85	Turbo Oil Line (2 Pc.)	
BUO1062	1986-87	3.8 Liter Turbo - Oil Cooler Hose Set	

## RIVIERA

Complete Brake Line Kit			Riviera
Part No.	Year	Description	O.E. Steel Stainless Steel
BU1011	1963	Power Brakes	
BU1035	1964-65		
BU1012	1967-69	Power Disc Brakes	
BU1057	1995	Brake Line Kit	
BU1068	1997-99	Standard Brakes	

Caliper Inlet Lines & Transfer Tubes (Sold in Pairs)			Riviera
Part No.	Year	Description	O.E. Steel Stainless Steel
BUD1002	1969	Caliper Inlet Lines	

Fuel - Pump To Carburetor Line			Riviera
Part No.	Year	Description	O.E. Steel Stainless Steel
BUC1019	1964	2 4 Barrel Carburetors (4 Pc.)	
BUC1002	1967-69	430 CID 4 Barrel	
SGC1004	1970-72	400 CID 455 CID 4 Barrel Quadrajet - Stage 1	
SGC1005	1970-72	455 CID - Non Stage 1	
BUC1020	1972	455 CID	

Fuel - Tank To Pump Line			Riviera
Part No.	Year	Description	O.E. Steel Stainless Steel
BUF1006	1963-65		
BUF1007	1967-69		

Fuel - Return Line			Riviera
Part No.	Year	Description	O.E. Steel Stainless Steel
BUR1001	1963-65		
BUR1002	1967-69		

Transmission Lines (Sold In Pairs)			Riviera
Part No.	Year	Description	O.E. Steel Stainless Steel
BUT1010	1961-63	Dyna Flow 300	
BUT1020	1963		
BUT1004	1964-65	Custom T-400	
BUT1005	1967-69	T-400	
BUT1019	1970	T-400	
BUT1017	1971	T-400 455 CID	
BUT1023	1979	350 CID	

Transmission Modulator Line			Riviera
Part No.	Year	Description	O.E. Steel Stainless Steel
BUM1005	1964	2 4 Barrel Carburetors TH400 Transmission	
SGM1001	1967	T-400	
BUM1001	1967-69	T-400	
BUM1004	1971	455 CID - Non Stage 1	
BUO1033	1971	455 CID - Non Stage 1	

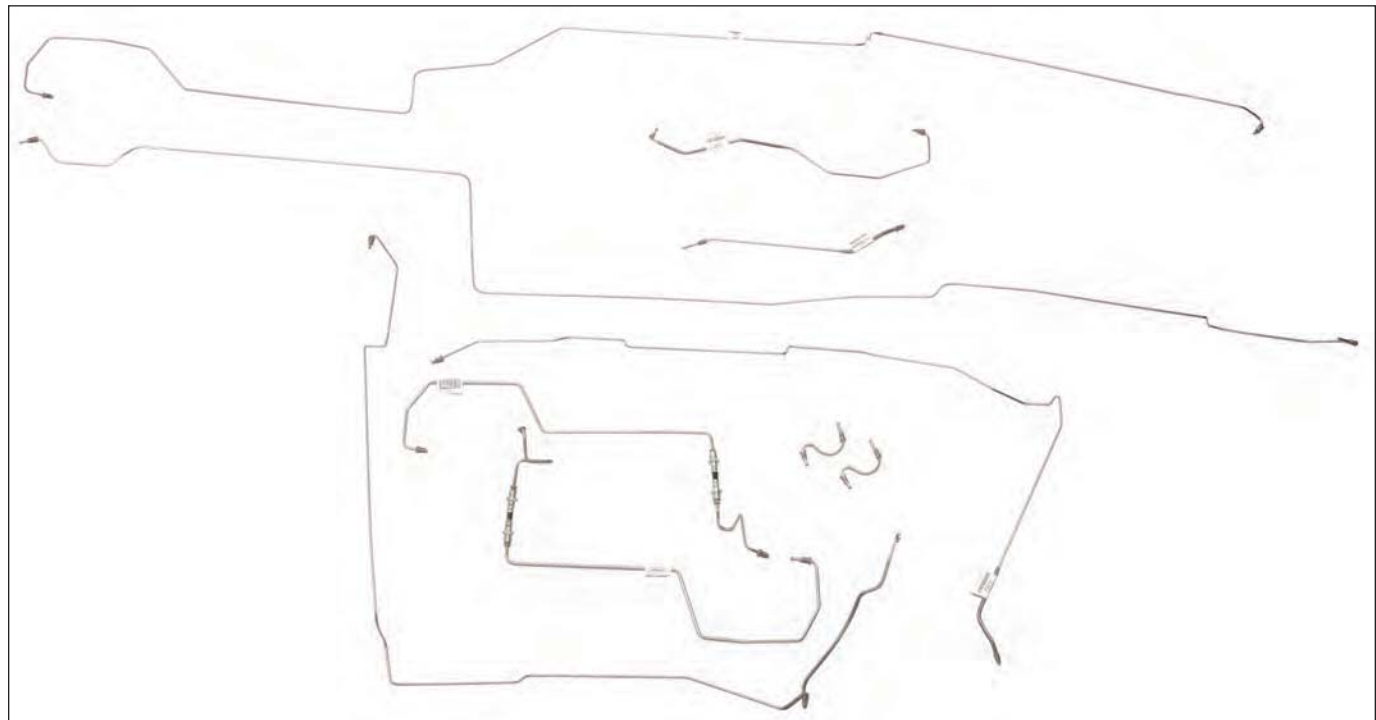

# BUICK

Choke Tube			Riviera	
Part No.	Year	Description	O.E. Steel	Stainless Steel
BUK1001	1964	2 4 Barrel Carburetors		

Miscellaneous & Other Lines			Riviera	
Part No.	Year	Description	O.E. Steel	Stainless Steel
BU01024	1967-69	Brake Booster Line		

## ROADMASTER

Complete Brake Line Kit			Roadmaster	
Part No.	Year	Description	O.E. Steel	Stainless Steel
BU1056	1940	Brake Line Kit		
BU1050	1941-42	76-C Brake Line Kit		
BU1033	1946-48	76-C Brake Line Kit		
BU1006	1954	76-C Standard Brakes		
BU1021	1955	Brake Line Kit		
BU1052	1957	Power Brake		
BU1038	1958	Power		
BU1062	1958	Standard Brake		

Fuel - Pump To Carburetor Line			Roadmaster	
Part No.	Year	Description	O.E. Steel	Stainless Steel
BUC1017	1940	Stromberg Carburetor		
BUC1021	1940	Carter Carburetor		
BUC1016	1941	(3 Pc.)		
BUC1018	1950			
BUC1005	1954			

Fuel - Tank To Pump Line			Roadmaster	
Part No.	Year	Description	O.E. Steel	Stainless Steel
BUF1036	1941	76-C		
BUF1017	1947	Convertible		
BUF1022	1950	(3 Pc.)		
BUF1032	1952	5/16"		
BUF1004	1954	Convertible		

Transmission Lines (Sold In Pairs)			Roadmaster	
Part No.	Year	Description	O.E. Steel	Stainless Steel
BUT1021	1993			



Miscellaneous & Other Lines			Roadmaster	
Part No.	Year	Description	O.E. Steel	Stainless Steel
BU01012	1941	Oil Line Set - (3 Pc.)		
BU01052	1941	Fuel Pump to Intake Line		
BU01053	1941	Fuel Pump to Wiper Line		
BU01030	1952	Oil Lines (2 Pc.)		
BU01003	1954	Hydraulic Power Window Lines		
BU01005	1954	Brake Booster Vacuum Line		
BU01006	1954	Vacuum Line - 3/8"		
BU01007	1954	Vacuum Line - 1/4"		
BU01008	1954	Power Brake Booster Supply Line		
BU01050	1954	Convertible Top Lines		



# BUICK

## SKYLARK / GS

### Complete Brake Line Kit

Part No.	Year	Description	Skylark / GS	
			O.E. Steel	Stainless Steel
BU1059	1954	Brake Line Kit		
SG1002	1964-65	Skylark Only - Hardtop - Standard Drum - 6 Cylinder		
SG1003	1964-65	Skylark Only - Hardtop - Power Drum - 6 Cylinder		
SG1004	1964-65	Skylark Only - Convertible - Standard Drum - 6 Cylinder		
SG1005	1964-65	Skylark Only - Convertible - Power Drum - 6 Cylinder		
SG1006	1964-65	Hardtop - Standard Drum - V8		
SG1008	1964-65	Convertible - Standard Drum - V8		
SG1009	1964-65	Hardtop - Power Drum - V8		
SG1036	1964-65	Convertible - Power Drum - V8		
CU1003	1966	Convertible - Standard Drum - V8		
CU1005	1966	Hardtop - Standard Drum - V8		
CU1006	1966	Hardtop - Power Drum - V8		
CU1008	1966	Convertible - Power Drum - V8		
SG1010	1966	Skylark Only - Hardtop - Standard Drum - 6 Cylinder		
SG1011	1966	Skylark Only - Hardtop - Power Drum - 6 Cylinder		
SG1013	1966	Skylark Only - Convertible - Standard Drum - 6 Cylinder		
SG1037	1966	Skylark Only - Convertible - Power Drum - 6 Cylinder		
CU1009	1967	Hardtop - Standard Drum - 6 Cylinder		
CU1010	1967	Hardtop - Power Drum - 6 Cylinder		
CU1012	1967	Hardtop - Power Disc - 6 Cylinder		
CU1013	1967	Convertible - Standard Drum - 6 Cylinder		
CU1014	1967	Convertible - Power Drum - 6 Cylinder		
CU1045	1967	Convertible - Power Disc - 6 Cylinder		
CU1016	1967	Convertible - Power Disc - V8		
CU1040	1967	Hardtop - Standard Drum - V8		
CU1041	1967	Hardtop - Power Drum - V8		
CU1042	1967	Hardtop - Power Disc - V8		
CU1043	1967	Convertible - Standard Drum - V8		
CU1044	1967	Convertible - Power Drum - V8		
CU1033	1968-69	Hardtop - Standard Disc		
SG1022	1968-69	Hardtop - Standard Drum		
SG1023	1968-69	Hardtop - Power Drum		

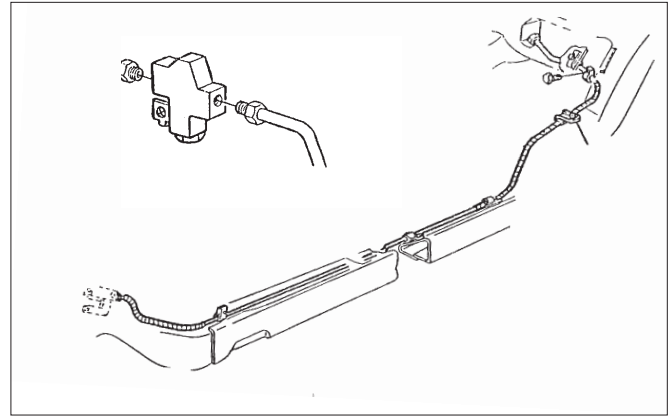

SG1024	1968-69	Hardtop - Power Disc
SG1025	1968-69	Convertible - Standard Drum
SG1026	1968-69	Convertible - Power Drum
SG1027	1968-69	Convertible - Power Disc
CU1023	1970	Hardtop - Standard Disc
CU1024	1970	Convertible - Standard Disc
SG1028	1970	Hardtop - Power Disc
SG1029	1970	Convertible - Power Disc
SG1030	1970	Hardtop - Standard Drum
SG1031	1970	Hardtop - Power Drum
SG1033	1970	Convertible - Standard Drum
SG1034	1970	Convertible - Power Drum
CU1025	1971-72	Hardtop - Standard Drum
CU1026	1971-72	Hardtop - Power Drum
CU1028	1971-72	Convertible - Standard Drum
CU1029	1971-72	Convertible - Power Drum
SG1032	1971-72	Hardtop - Power Disc
SG1035	1971-72	Convertible - Power Disc

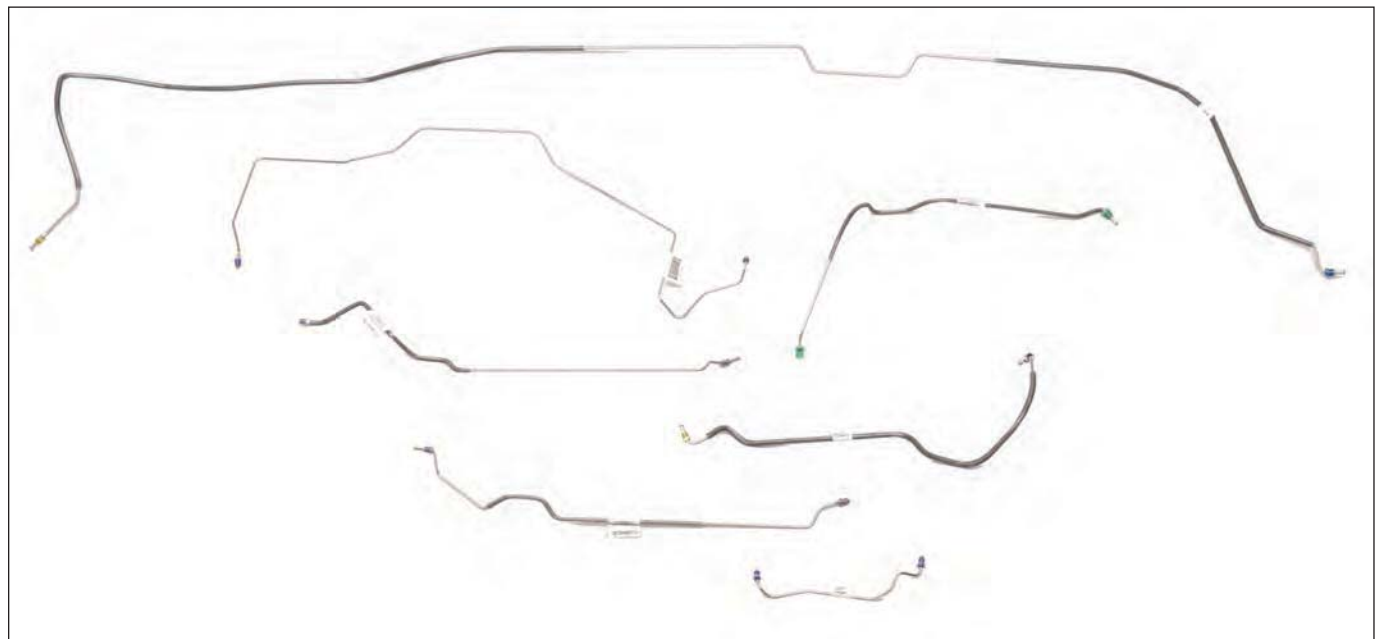

# BUICK

### Caliper Inlet Lines & Transfer Tubes (Sold in Pairs) Skylark / GS

Part No.	Year	Description	O.E. Steel	Stainless Steel
CUD1001	1967	Disc (Inlet 3/8" and 3/8")		
GLD1001	1967	Disc (Inlet 7/16" and 1/2")		
GLD1003	1968	Disc (Inlet 7/16" and 1/2")		

### Fuel - Pump To Carburetor Line Skylark / GS

Part No.	Year	Description	O.E. Steel	Stainless Steel
SGC1007	1954	All Models		
SGC1006	1967-68	401 CID & 430 CID 4 Barrel		
SGC1001	1968-72	350 CID 2 Barrel No A/C		
SGC1002	1968-72	350 CID 4 Barrel Quadrajel No A/C		
SGC1005	1969	400 CID		
SGC1004	1970-72	400 CID 455 CID 4 Barrel Quadrajel - Stage 1		
SGC1005	1970-72	455 CID Non-Stage 1		
SGC1008	1971	455 CID Non-Stage 1 with long bowl fuel pump		
SGC1003	1972	350 CID 2 Barrel A/C		

### Fuel - Tank To Pump Line Skylark / GS

Part No.	Year	Description	O.E. Steel	Stainless Steel
SGF1012	1954	Skylark Hardtop - 5/16"		
GLF1001	1964-66	Hardtop - 3/8"		
GLF1002	1964-66	Convertible - 3/8"		
GLF1018	1964-66	Skylark Only - 5/16 - Hardtop - Right Side Routed - Inline 6		
GLF1019	1964-66	3/8" Hardtop Right Side Routed V8		
SGF1003	1964-66	Skylark Only - Convertible - 5/16"		
GLF1003	1967	Hardtop - 3/8"		
GLF1004	1967	Convertible - 3/8"		
SGF1004	1967	Skylark Only - Hardtop - 5/16"		
GLF1007	1968-69	Convertible - 3/8"		
SGF1008	1968-69	Skylark Only - Hardtop - 5/16" (1 Pc.)		
SGF1009	1968-69	Skylark Only - Convertible - 5/16" (1 Pc.)		
SGF1006	1970-72	Hardtop (2 Pc.)		
SGF1007	1970-72	Convertible - (2 Pc.)		

### Fuel - Return Line Skylark / GS

Part No.	Year	Description	O.E. Steel	Stainless Steel
GLR1002	1964-66	GS Convertible		
GLR1002	1964-66	Skylark Convertible		
GLR1003	1967	GS Hardtop		
GLR1003	1967	Skylark Hardtop		
GLR1004	1967	GS Convertible		
GLR1004	1967	Skylark Convertible		
GLR1005	1968-69	GS Hardtop		
GLR1005	1968-69	Skylark Hardtop		
GLR1006	1968-69	GS Convertible		
GLR1006	1968-69	Skylark Convertible		
SGR1003	1970-72	Hardtop - 1/4" (2 Pc.)		
SGR1003	1970-72	GS Hardtop - 1/4" (2 Pc.)		
SGR1003	1970-72	Skylark Hardtop - 1/4" (2 Pc.)		
SGR1004	1970-72	Convertible - 1/4"		
SGR1004	1970-72	GS Convertible - 1/4" (2 Pc.)		
SGR1004	1970-72	Skylark Convertible - 1/4" (2 Pc.)		

### Fuel - Vapor Line Skylark / GS

Part No.	Year	Description	O.E. Steel	Stainless Steel
SGV1001	1971-72	Hardtop - 5/16" (2 Pc.)		
SGV1002	1971-72	Convertible - 5/16" (2 Pc.)		

### Fuel - Stand Pipe Set Skylark / GS

Part No.	Year	Description	O.E. Steel	Stainless Steel
BUS1003	1970	California emissions (5 Pc.)		
BUS1005	1970	(3 Pc.)		
BUS1004	1971-72	Vent Set (3 Pc.)		

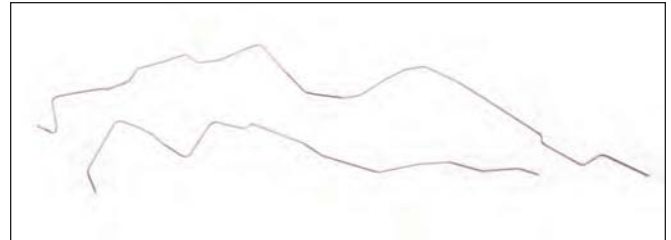

### Transmission Lines (Sold In Pairs) Skylark / GS

Part No.	Year	Description	O.E. Steel	Stainless Steel
SGT1007	1965	Super Turbine 300		
SGT1002	1967	T-400		
SGT1003	1967	Power Glide		
SGT1004	1968-71	T-350 & T-400		
SGT1006	1972	T-350 & T-400		
SGT1005	1979	T-350		

### Transmission Modulator Line Skylark / GS

Part No.	Year	Description	O.E. Steel	Stainless Steel
SGM1001	1967	T-400		
SGM1001	1967	GS T-400		
SGM1002	1968-72	T-350		
SGM1003	1968-72	T-400		
BU01051	1972	Skylark Only		

### Miscellaneous & Other Lines Skylark / GS

Part No.	Year	Description	O.E. Steel	Stainless Steel
BU01003	1954	Convertible - Hydraulic Power Window (11 Pc.)		
BU01005	1954	Brake Booster Vacuum Line		
BU01031	1965	Booster Vacuum Line		
BU01010	1969-72	Brake Booster Vacuum Line - 455 CID		
BU01011	1970-72	Booster Vacuum Line - 350 CID		

## WILDCAT

### Complete Brake Line Kit Wildcat

Part No.	Year	Description	O.E. Steel	Stainless Steel
BU1023	1965	Power Brakes		
BU1023	1965	Wildcat		
WI1007	1966	Power Drum		
BU1031	1967-68	Power Drum Brakes		
WI1002	1968-69	Hardtop - Power Drum		

### Fuel - Pump To Carburetor Line Wildcat

Part No.	Year	Description	O.E. Steel	Stainless Steel
SGC1006	1967-68	401 CID & 430 CID 4 Barrel		

### Fuel - Tank To Pump Line Wildcat

Part No.	Year	Description	O.E. Steel	Stainless Steel
BUF1020	1966			

### Fuel - Return Line Wildcat

Part No.	Year	Description	O.E. Steel	Stainless Steel
BUR1007	1966			

### Transmission Lines (Sold In Pairs) Wildcat

Part No.	Year	Description	O.E. Steel	Stainless Steel
BUT1004	1964-65	T-400		

# CADILLAC

## CADILLAC EARLY & MISC.

### Complete Brake Line Kit Cadillac Early & Misc.

Part No.	Year	Description	O.E. Steel	Stainless Steel
CD1016	1939	Coupe Series 62		
CD1002	1946-47	Series 61		
CD1025	1950	Series 61		
CD1003	1951-53	Coupe Deville Standard Brake		
CD1004	1953	Series 62 Power Brake		
CD1018	1954	Series 62 Convertible - Power Drum		
CD1026	1954	Series 62 Standard Brake		
CD1019	1955-56	Series 62 Power Brake		
CD1005	1956	Sedan Deville Standard Brake (6 Pc.)		
CD1006	1957	Series 60 Fleetwood		
CD1020	1958	Sedan Deville		
CD1007	1959	Coupe Deville Power Drum Hardtop		
CD1008	1960	Eldorado Power Drum		
CD1009	1960	Series 62 Convertible - Power Drum		
CD1015	1960	Limousine		
CD1024	1960	Coupe Deville Power Drum Hardtop (6 Pc)		
CD1011	1962-64	Series 63 Power Brakes		
CD1021	1965	Fleetwood 133" WB		
CD1014	1969-70	Series 75 Fleetwood Limousine (10 Pc.)		
CD1017	1979	Coupe Deville Power Disc (7 Pc.)		
CD1022	1991-92	Sedan Deville with ABS		
CT1272	2000	2WD Escalade 1500		
CT1251	2002-03	Truck 1500 4WD with AWD Active Brake System		
CT1250	2004-06	Truck 1500 4WD with AWD ESC Active Brake System		

### Fuel - Pump To Carburetor Line Cadillac Early & Misc.

Part No.	Year	Description	O.E. Steel	Stainless Steel
CDC1007	1946-48	All Models 346 CID 2 Barrel Carter		
CDC1008	1947	Carburetor Vent Line		
CDC1004	1956	All Models Fuel - Filter to Carburetor		
CDC1008	1957	Series 62 365 CID (2 Pc.)		
CDC1016	1957	Series 62 Carter Carburetor		
CDC1017	1957	All Models 365 CID 2 x 4 BBL		
CDC1019	1957	Rochester Carburetor		
CDC1006	1958	Eldorado Tri-Power (3 Pc.)		
CDC1022	1958	Single Carter Four Barrel - Carburetor To Filter Line		
CDC1011	1959	Eldorado Tri-Power (3 Pc.)		
CDC1001	1959-60	Coupe Deville 390 CID 4 Barrel		
CDC1018	1960	[3] 2 Barrel Carburetors		
CDC1013	1963-66	Coupe Deville Quadrajel (2 Pc.)		
CDC1014	1963-66	Coupe Deville Carter (2 Pc.)		
CDC1021	1965	All Models		
CDC1005	1968	All Models Fuel Pump to Filter (2 Pc.)		
CDC1009	1969-71	75 Series 472 CID 4 Barrel		
CDC1009	1969-71	Eldorado 500 CID 4 Barrel		
CDC1012	1970	Series 75 472 CID 4 Barrel		
CDC1002	1972	Coupe Deville 500 CID 4 Barrel Carburetor		
CDC1002	1973-76	Eldorado 500 CID 4 Barrel Carburetor		
CDC1003	1978	Eldorado 425 CID - 3/8"		

### Fuel - Tank To Pump Line Cadillac Early & Misc.

Part No.	Year	Description	O.E. Steel	Stainless Steel
CDF1001	1940	Series 75 Commercial		
CDF1002	1946-48	Series 61		
CDF1003	1951-53	All Models Fuel - Tank Line		
CDF1012	1954	Series 62 Hardtop and Convertible		
CDF1007	1956	All Models Fuel - Tank Line - 5/16"		
CDF1006	1957	All Models Fuel - Tank Line - 5/16" (2 Pc.)		
CDF1014	1958	Sedan Deville		
CDF1016	1958	Eldorado Convertible		
CDF1004	1958-60	Coupe Deville 5/16" (1 Pc.)		
CDF1008	1958-60	Coupe Deville 3/8" (1 Pc.)		
CDF1015	1959	Eldorado 2 Door		
CDF1005	1960	Eldorado 5/16" (1 Pc.)		
CDF1009	1960	Limousine		
CDF1010	1961-64	All Models Fuel - Tank Line		
CDF1011	1964	Deville Convertible		
CDF1013	1985	Deville		



### Fuel - Return Line Cadillac Early & Misc.

Part No.	Year	Description	O.E. Steel	Stainless Steel
CDR1005	1957	All Models (2 Pc.)		
CDR1001	1958-60	Coupe Deville 1/4"		
CDR1006	1959	Eldorado 2 Door		
CDR1007	1959	Eldorado Convertible		
CDR1002	1960	Eldorado 1/4"		
CDR1003	1960	Limousine 1/4"		
CDR1004	1961	Deville Convertible		
CTF1162	2003-06	Escalade With AWD		
CTR1102	2003-06	Escalade With AWD		
CTV1076	2003-06	Truck Escalade With AWD		

### Transmission Lines (Sold In Pairs) Cadillac Early & Misc.

Part No.	Year	Description	O.E. Steel	Stainless Steel
CDT1001	1959-60	Eldorado Coupe Deville (4 pc.)		
CDT1003	1960	Limousine		
CDT1011	1961-64	Coupe Deville Transmission lines		
CDT1006	1964	Fleetwood Deville 390 CID - T-400		
CDT1009	1965	All Models T-400		
CDT1005	1969-71	Eldorado 472 CID & 500 CID - T-400 - Front Wheel Drive		
CDT1007	1970	Eldorado Series 75 472 CID - 4 Barrel		
CDT1008	1971-75	Coupe Deville		
CDT1002	1973-76	Eldorado		
CDT1010	1979	Fleetwood 425 CID - T-400		
CDT1004	1982	Sedan Deville (4 Pc.)		

### Choke Tube Cadillac Early & Misc.

Part No.	Year	Description	O.E. Steel	Stainless Steel
CDK1003	1955	Series 62 (1 Pc.)		
CDK1001	1957	Series 62 65 CID 4 Barrel - Heat Riser Tube		
CDK1002	1958-60	Coupe Deville Rochester WCFB Carburetor		

### Miscellaneous & Other Lines Cadillac Early & Misc.

Part No.	Year	Description	O.E. Steel	Stainless Steel
CD01001	1947	All Models Engine Oil Line		
CD01007	1947	All Models Wiper to Pump (2 Pc.)		
CD01002	1947-49	All Models Hydraulic Convertible Top - Line Set (22 Pc.)		
CD01003	1952	All Models Hydraulic Convertible Top - Line Set		
CD01004	1952-53	All Models Power Steering Line - 3/8"		
CD01023	1953	Coupe Deville Hydraulic Window Lines ( 8 Pc. )		
CD01015	1955	Series 62 Oil Line Set (2 Pc.)		
CD01016	1955	Series 62 Vacuum Line Set (3 Pc.)		
CD01022	1956	Sedan Deville Distributor to Vacuum Line		
CD01006	1957	Series 62 365 CID - Manifold to Air Cleaner		
CD01009	1957	All Models Distributor Vacuum Line		
CD01017	1958	Sedan Deville Vacuum Advance Line		
CD01018	1958	Sedan Deville Intake To Wiper		
CD01019	1958	Sedan Deville To Master Cylinder		
CD01020	1958	Sedan Deville Oil Pump to Wiper		
CD01021	1958	Sedan Deville Manifold to Booster		
CD01005	1959	Eldorado V8 390 CID - Oil Filter Bypass Inlet & Outlet Line (2 Pc.)		
CD01012	1959	Eldorado Tri-Power Booster Vacuum Line		
CD01010	1961-65	All Models Air Conditioning Lines		
CD01011	1970	Series 75 472 CID 4 Barrel Power Steering Line		
CD01013	1970	All Models Power Steering Line Set (2 Pc.)		
CD01014	1980	Coupe Deville Oil Cooler Line Set		

# CHEVROLET

## CHEVROLET EARLY & MISC.

### Complete Brake Line Kit

Part No.	Year	Description	Chevrolet Early & Misc.	
			O.E. Steel	Stainless Steel
CH1023	1936	Standard		
CH1016	1938	Master Deluxe		
CH1002	1939	Master Deluxe		
CH1003	1939	Master Deluxe (7 Pc.)		
CH1004	1940	Master Deluxe & Special Deluxe Sedan		
CH1014	1941-42	Master Deluxe		
CH1014	1941-42	Special Deluxe		
CH1014	1946-48	Fleetline		
CH1014	1946-48	Style Master		
CH1014	1946-48	Fleet Master		
CH1005	1949	Fleetline Deluxe 2 Door - Sedan		
CH1006	1952	All Models		
IB1065	1959-60	Brookwood Standard Brake		
IB1066	1959-60	Brookwood Power Brake		
CH1024	1960-62	Corvair Standard Brake		
CH1008	1963-64	Corvair		
CH1019	1965	Corvair		
CH1009	1966	Corvair		
CH1018	1967-69	Corvair		
VG1001	1971	Vega		
CH1021	1988-89	Beretta 2.8 Liter V6		
CH1021	1988-90	Corsica 2.8 Liter V6		
CU1046	1990-94	Lumina Non - ABS		
CH1017	1991-96	Beretta Power Brake		
CH1017	1991-96	Corsica Power Brake		
BU1047	1992-94	Lumina With ABS		
CH1022	1995-99	Lumina Non ABS - Rear Drum		
MC1010	1997-01	Lumina With ABS - Rear Disc		
IB1064	2000-01	Lumina Non ABS - Rear Disc		

### Fuel - Pump To Carburetor Line

Part No.	Year	Description	Chevrolet Early & Misc.	
			O.E. Steel	Stainless Steel
CHC1001	1938	Master Deluxe		
CHC1003	1941	Special Deluxe		
CHC1005	1946	Sedan 216 CID - 6 Cylinder		
CHC1006	1951	All Models		
CHC1002	1960	All Models		

### Fuel - Tank To Pump Line

Part No.	Year	Description	Chevrolet Early & Misc.	
			O.E. Steel	Stainless Steel
CHF1011	1931	All Models		
CHF1012	1932	All Models		
CHF1014	1933	Master 4 Door		
CHF1006	1936	Master Deluxe		
CHF1010	1937			
CHF1005	1937-38	Master Deluxe		
CHF1004	1939	Master Deluxe Set (3 Pc.)		
CHF1007	1941	Special Deluxe		
CHF1016	1948	Fleetline & Styleline 5/16"		
IBF1022	1955-57	Nomad Fuel - Tank Line		
CHF1002	1960-63	Corvair		
CHF1008	1964-65	Corvair		
CHF1003	1966-68	Corvair		
CHF1015	1969	Corvair 5/16"		
MCF1003	1973-75	Laguna V8 - 3/8"		
CHF1013	1977	Monza (2 Pc.)		
CHF1018	1988-89	Beretta 2.8 Liter V6		
CUF1011	1988-91	Lumina 3.1 Liter - 3/8"		
CHF1019	1996	Lumina 4 Door		
CHF1017	1998	Cavalier 4 Door		

### Fuel - Return Line

Part No.	Year	Description	Chevrolet Early & Misc.	
			O.E. Steel	Stainless Steel
CHR1003	1952	4 Door Sedan		
CHR1001	1960-63	Corvair 3/16" (2 Pc.)		
CHR1002	1969	Corvair 3/16" (2 Pc.)		
MCR1003	1973-75	Laguna		
CHR1005	1988-89	Beretta 2.8 Liter V6		
CUR1010	1988-91	Lumina 3.1 Liter		
CHR1004	1998	Cavalier 4 Door		

### Fuel - Vapor Line

Part No.	Year	Description	Chevrolet Early & Misc.	
			O.E. Steel	Stainless Steel
MCV1003	1973-75	Laguna		
CHV1002	1988-89	Beretta 2.8 Liter V6		
CUV1007	1988-91	Lumina 3.1 Liter		
CHV1003	1996-99	Lumina 4 Door		
CHV1001	1998	Cavalier 4 Door		

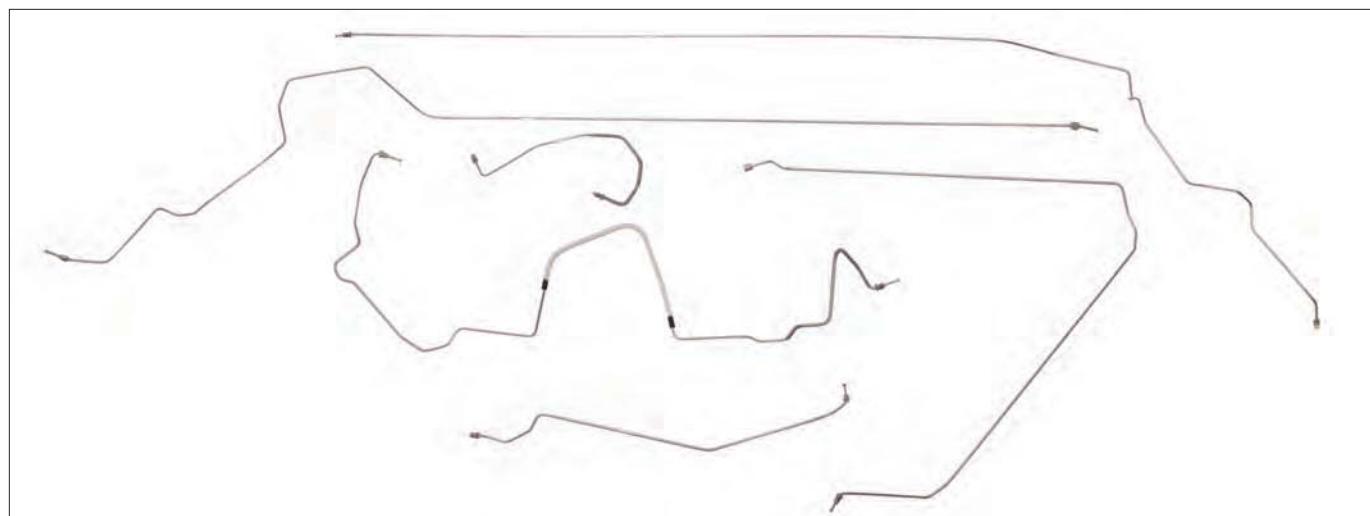

## CHEVROLET

### Fuel - Stand Pipe Set Chevrolet Early & Misc.

Part No.	Year	Description	O.E. Steel	Stainless Steel
BUS1002	1988-91	Lumina (3 Pc.) Fuel Injected		

### Transmission Lines (Sold In Pairs) Chevrolet Early & Misc.

Part No.	Year	Description	O.E. Steel	Stainless Steel
GPT1006	1990-94	Lumina 3.1 V6 4T60E Transmission		
CHT1001	1997	Lumina 3.1 Liter Radiator to Hose (2 Pc.)		

### Miscellaneous & Other Lines Chevrolet Early & Misc.

Part No.	Year	Description	O.E. Steel	Stainless Steel
CHO1013	1937	Master Deluxe 2 Door 57" Long Vacuum Line 1/8"		
CHO1014	1937	Master Deluxe 2 Door 1/8" 24" Long Vacuum Line		
CHO1009	1938-39	Master Deluxe 3/16" Distributor Vacuum Advance		
CHO1007	1939	Master Deluxe 1/4" Vacuum		
CHO1008	1939	Master Deluxe 1/8" Oil Line		
CHO1012	1941	Distributor Vacuum Advance Line		
CHO1011	1953	All Models Power Steering - Set (3 Pc.)		
CHO1015	1988-89	Beretta 2.8 Liter V6 - Power Steering Line		

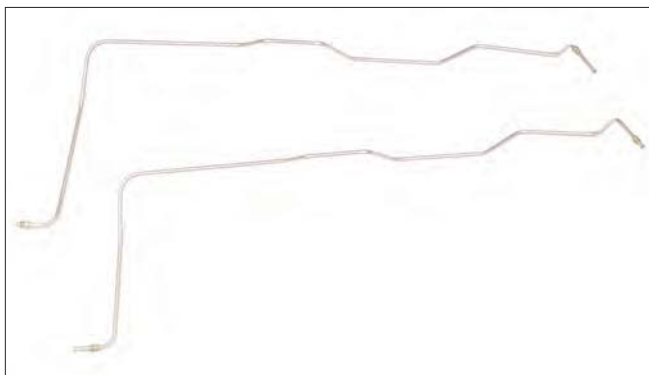

### Transmission Lines (Sold In Pairs) Bel Air

Part No.	Year	Description	O.E. Steel	Stainless Steel
IBT1014	1955	Powerglide - 6 Cylinder - Left Side Routing		
IBT1001	1955-57	Powerglide - 6 Cylinder - Right Side Routing		
IBT1002	1955-57	Powerglide - V8		
IBT1004	1958-60	Powerglide		
IBT1005	1958-60	Turboglide		
IBT1013	1963-64	Powerglide		

## BEL AIR

### Complete Brake Line Kit Bel Air

Part No.	Year	Description	O.E. Steel	Stainless Steel
IB1050	1953-54	Standard Brake		
IB1001	1955-56	Standard Brake		
IB1002	1955-56	Power Brake		
IB1054	1955-56	Standard Brake - Front to Rear Outside Frame		
IB1055	1955-56	Power Brake - Front to Rear Outside Frame		
IB1003	1957	Standard Brake		
IB1004	1957	Power Brake		
IB1056	1957	Standard Brake - Front to Rear Outside Frame		
IB1057	1957	Power Brake - Front to Rear Outside Frame		

### Choke Tube Bel Air

Part No.	Year	Description	O.E. Steel	Stainless Steel
IBK1002	1955-56			

### Fuel - Pump To Carburetor Line Bel Air

Part No.	Year	Description	O.E. Steel	Stainless Steel
IBC1004	1956	V8 - 2 & 4 Barrel (2 Pc.)		
IBC1003	1956-57	V8 - 4 Barrel - 5/16"		

### Fuel - Tank To Pump Line Bel Air

Part No.	Year	Description	O.E. Steel	Stainless Steel
IBF1001	1955-57	6 Cylinder		
IBF1002	1955-57	Hardtop - V8 - 2 Barrel		
IBF1003	1955-57	Convertible - V8 - 2 Barrel		
IBF1004	1955-57	V8 - 4 Barrel		

## BISCAYNE

### Complete Brake Line Kit Biscayne

Part No.	Year	Description	O.E. Steel	Stainless Steel
IB1045	1958	Standard Brake		
IB1046	1958	Power Brake		
IB1005	1959-61	Standard Brake		
IB1006	1959-61	Power Brake		
IB1007	1962-64	Standard Brake		
IB1008	1962-64	Power Brake		
IB1009	1965	Hardtop - Standard Brake		
IB1010	1965	Hardtop - Power Brake		
IB1013	1966	Standard Brake		
IB1014	1966	Hardtop - Power Brake		
IB1017	1967	Hardtop - Standard Drum		

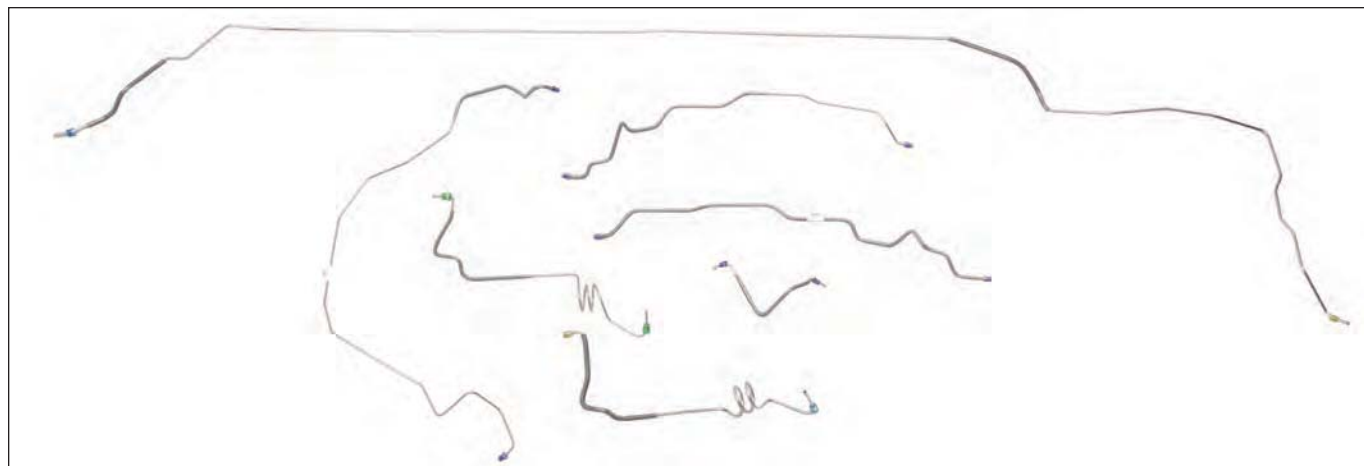

# CHEVROLET

IB1018	1967	Hardtop - Power Drum
IB1020	1967	Hardtop - Power Disc
IB1067	1967	Convertible Standard Drum
IB1068	1967	Convertible Power Drum
IB1069	1967	Convertible Power Disc
IB1025	1968	Hardtop - Standard Drum
IB1026	1968	Hardtop - Power Drum
IB1027	1968	Hardtop - Power Disc
IB1070	1968	Convertible Standard Drum
IB1071	1968	Convertible Power Drum
IB1072	1968	Convertible Power Disc
IB1028	1969	Hardtop - Standard Drum
IB1029	1969	Hardtop - Power Drum
IB1030	1969	Hardtop - Power Disc
IB1051	1969	Hardtop - Power Disc - With 427 CID Motor
IB1073	1969	Convertible Standard Drum
IB1074	1969	Convertible Power Drum
IB1075	1969	Convertible Power Disc
IB1076	1969	Convertible Power Disc with 427 CID Motor
IB1033	1970	Hardtop - Power Disc
IB1079	1970	Convertible Power Disc
IB1038	1971-73	Hardtop - Power Disc
IB1040	1971-73	Convertible - Power Disc
IB1061	1974-75	Convertible Power Disc

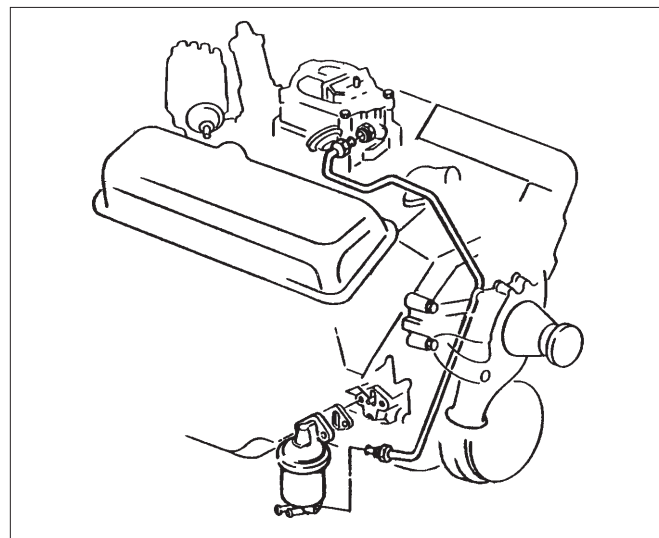

IBF1013	1965	3/8"
IBF1014	1967-68	5/16"
IBF1015	1967-68	3/8"

Fuel - Pump To Carburetor Line			Biscayne	
Part No.	Year	Description	O.E. Steel	Stainless Steel
IBC1008	1959-61	348 CID - 3-2 Barrel (3 Pc.) - Tri-Power		

Transmission Lines (Sold In Pairs)			Biscayne	
Part No.	Year	Description	O.E. Steel	Stainless Steel
IBT1004	1958-60	Powerglide		
IBT1005	1958-60	Turboglide		
IBT1013	1963-64	Powerglide		
IBT1012	1968	T-400		

Fuel - Tank To Pump Line			Biscayne	
Part No.	Year	Description	O.E. Steel	Stainless Steel
IBF1006	1958	V8 - Set - Inside Frame - 3/8" (3 Pc.)		
IBF1009	1959-61	V8 - 5/16"		
IBF1008	1959-62	V8 - Set - Inside Frame - 3/8" (3 Pc.)		
IBF1011	1963-64	V8 - Set - 3/8" (3 Pc.)		
IBF1012	1965	5/16"		

Transmission Modulator Line			Biscayne	
Part No.	Year	Description	O.E. Steel	Stainless Steel
IBM1003	1967	Powerglide		

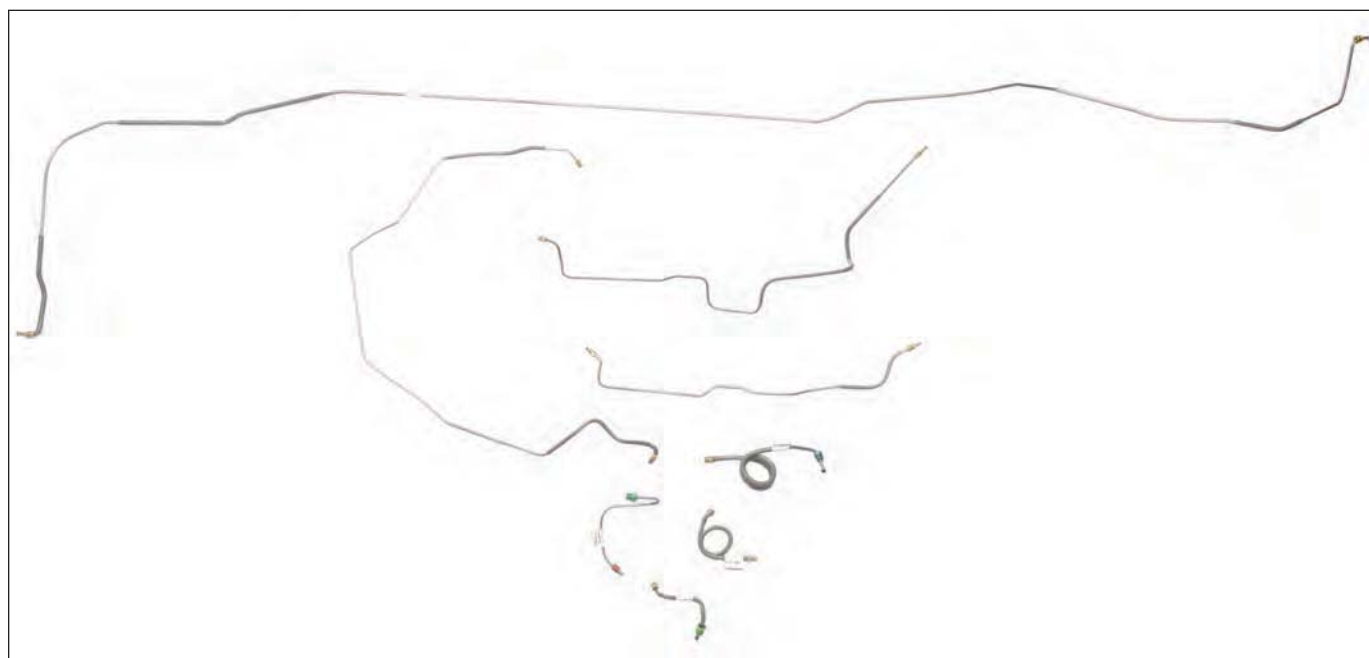

# CHEVROLET

## CAPRICE

### Complete Brake Line Kit

Part No.	Year	Description	O.E. Steel	Caprice Stainless Steel
IB1013	1966	Standard Brake		
IB1014	1966	Hardtop - Power Brake		
IB1017	1967	Hardtop - Standard Drum		
IB1018	1967	Hardtop - Power Drum		
IB1020	1967	Hardtop - Power Disc		
IB1067	1967	Convertible Standard Drum		
IB1068	1967	Convertible Power Drum		
IB1069	1967	Convertible Power Disc		
IB1025	1968	Hardtop - Standard Drum		
IB1026	1968	Hardtop - Power Drum		
IB1027	1968	Hardtop - Power Disc		
IB1070	1968	Convertible Standard Drum		
IB1071	1968	Convertible Power Drum		
IB1072	1968	Convertible Power Disc		
IB1028	1969	Hardtop - Standard Drum		
IB1029	1969	Hardtop - Power Drum		
IB1030	1969	Hardtop - Power Disc		
IB1051	1969	Hardtop - Power Disc - With 427 CID Motor		
IB1073	1969	Convertible Standard Drum		
IB1074	1969	Convertible Power Drum		
IB1075	1969	Convertible Power Disc		
IB1076	1969	Convertible Power Disc with 427 CID Motor		
IB1033	1970	Hardtop - Power Disc		
IB1079	1970	Convertible Power Disc		
IB1038	1971-73	Hardtop - Power Disc		
IB1040	1971-76	Convertible - Power Disc		
IB1061	1974-76	Convertible Power Disc		
IB1053	1986-90	4 Door 4.3 Liter V6		
IB1048	1991-94	Rear Drum (9 Pc.)		
IB1052	1994	Rear Disc		
IB1049	1995-96	Rear Disc		
IB1062	1995-96	Rear Drum		

### Fuel - Pump To Carburetor Line

Part No.	Year	Description	O.E. Steel	Caprice Stainless Steel
IBC1013	1966	283 - 2 Barrel - 5/16"		
IBC1012	1973-77	350 CID - 2 Barrel and 4 Barrel		

### Fuel - Tank To Pump Line

Part No.	Year	Description	O.E. Steel	Caprice Stainless Steel
IBF1028	1966	Wagon		
IBF1014	1967-68	5/16"		
IBF1015	1967-68	3/8"		

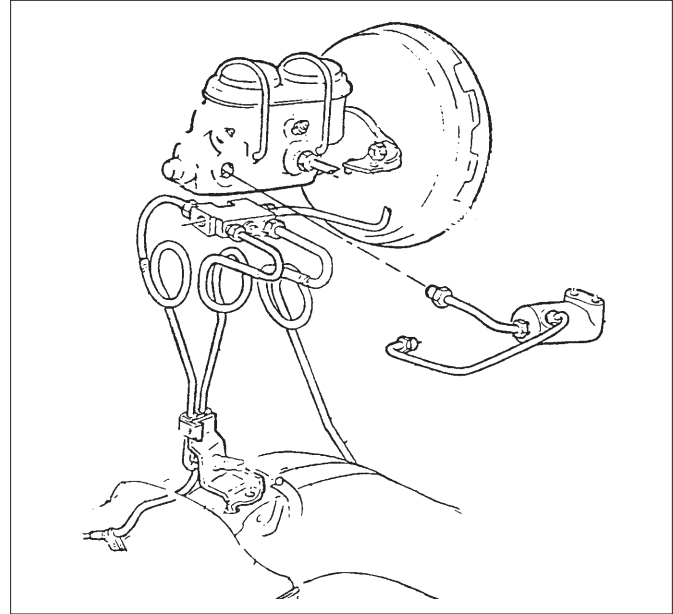
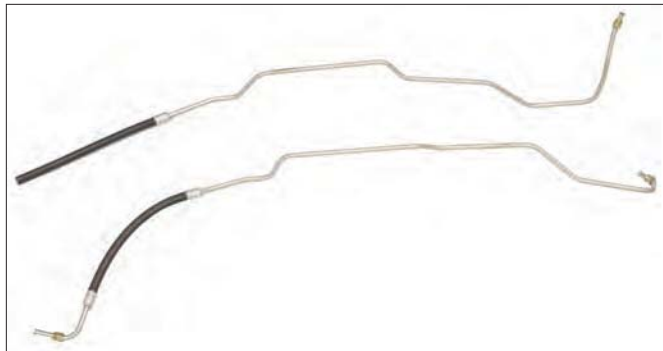

IBF1025	1969	427 CID Hardtop
IBF1018	1971-76	Convertible
IBF1019	1974-76	Hardtop
IBF1029	1987	4 Door Hardtop V8 Engine
IBF1026	1987-88	4 Door 4.3 Liter V6 (3 Pc.)

### Fuel - Return Line

Part No.	Year	Description	O.E. Steel	Caprice Stainless Steel
IBR1002	1971-76			
IBR1009	1987	4 Door Hardtop V8 Engine		
IBR1008	1987-88	4 Door 4.3 Liter V-6 (2 Pc.)		
IBR1005	1989	Fuel - Rail Injection Line 305 CID		

### Fuel - Vapor Line

Part No.	Year	Description	O.E. Steel	Caprice Stainless Steel
IBV1004	1974-76	Convertible		
IBV1007	1987	4 Door 4.3L V-6		
IBV1009	1987	4 Door Hardtop V8 Engine		

### Fuel - Vent Line

Part No.	Year	Description	O.E. Steel	Caprice Stainless Steel
IBV1006	1969	Tank Vent Line 427 CID Hardtop		

### Fuel - Miscellaneous

Part No.	Year	Description	O.E. Steel	Caprice Stainless Steel
IBF1027	1987	4 Door 4.3 Liter V-6 - FI Feed Line (2 Pc.)		
IBF1023	1989	Fuel - Rail Feed Line		
IBF1024	1991-96	V8 Throttle Body Injection - Feed Line		

### Transmission Lines (Sold In Pairs)

Part No.	Year	Description	O.E. Steel	Caprice Stainless Steel
IBT1012	1968	T-400		
IBT1009	1973-76	T-350 And T-400		
IBT1017	1987	4 Door 4.3L V-6		

### Transmission Modulator Line

Part No.	Year	Description	O.E. Steel	Caprice Stainless Steel
IBM1003	1967	Powerglide		
IBM1004	1975			

# CHEVROLET

Choke Tube			Caprice	
Part No.	Year	Description	O.E. Steel	Stainless Steel
IBK1001	1974-77	350 CID - 4 Barrel		

Miscellaneous & Other Lines			Caprice	
Part No.	Year	Description	O.E. Steel	Stainless Steel
CH01005	1965	283 CID - 220 HP - 4 Barrel - Distributor Vacuum Line		
IB01004	1965	Distributor Vacuum Line		
IB01001	1974-77	Brake Booster Vacuum		
IB01002	1974-77	Power Steering Line		

## IMPALA

Complete Brake Line Kit			Impala	
Part No.	Year	Description	O.E. Steel	Stainless Steel
IB1045	1958	Standard Brake		
IB1046	1958	Power Brake - Bendix Treadle Vacuum Booster		
IB1005	1959-61	Standard Brake		
IB1006	1959-61	Power Brake		
IB1007	1962-64	Standard Brake		
IB1008	1962-64	Power Brake		
IB1009	1965	Hardtop - Standard Brake		
IB1010	1965	Hardtop - Power Brake		
IB1013	1966	Hardtop - Standard Brake		
IB1014	1966	Hardtop - Power Brake		
IB1017	1967	Hardtop - Standard Drum		
IB1018	1967	Hardtop - Power Drum		
IB1020	1967	Hardtop - Power Disc		
IB1067	1967	Convertible Standard Drum		
IB1068	1967	Convertible Power Drum		
IB1069	1967	Convertible Power Disc		
IB1025	1968	Hardtop - Standard Drum		
IB1026	1968	Hardtop - Power Drum		
IB1027	1968	Hardtop - Power Disc		
IB1070	1968	Convertible Standard Drum		
IB1071	1968	Convertible Power Drum		
IB1072	1968	Convertible Power Disc		
IB1028	1969	Hardtop - Standard Drum		
IB1029	1969	Hardtop - Power Drum		
IB1030	1969	Hardtop - Power Disc		
IB1051	1969	Hardtop - Power Disc - With 427 CID Motor		
IB1073	1969	Convertible Standard Drum		
IB1074	1969	Convertible Power Drum		
IB1075	1969	Convertible Power Disc		
IB1076	1969	Convertible Power Disc with 427 CID Motor		
IB1031	1970	Hardtop - Standard Drum		
IB1032	1970	Hardtop - Power Drum		
IB1033	1970	Hardtop - Power Disc		
IB1077	1970	Convertible Standard Drum		
IB1078	1970	Convertible Power Drum		
IB1079	1970	Convertible Power Disc		
IB1038	1971-73	Hardtop - Power Disc		
IB1040	1971-73	Convertible - Power Disc		
IB1061	1974-76	Convertible Power Disc		
IB1052	1994	SS Rear Disc		
IB1049	1995-96	SS Rear Disc		
IB1064	2000-01	Non ABS - Rear Disc		
MC1010	2000-01	With ABS - Rear Disc		
IB1063	2002-05	With ABS - Rear Disc		

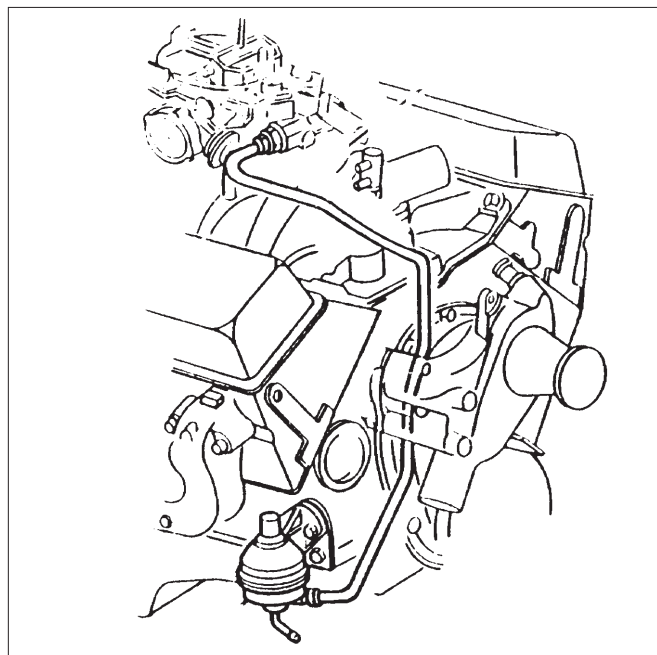

IB1033	1970	Hardtop - Power Disc		
IB1077	1970	Convertible Standard Drum		
IB1078	1970	Convertible Power Drum		
IB1079	1970	Convertible Power Disc		
IB1038	1971-73	Hardtop - Power Disc		
IB1040	1971-73	Convertible - Power Disc		
IB1061	1974-76	Convertible Power Disc		
IB1052	1994	SS Rear Disc		
IB1049	1995-96	SS Rear Disc		
IB1064	2000-01	Non ABS - Rear Disc		
MC1010	2000-01	With ABS - Rear Disc		
IB1063	2002-05	With ABS - Rear Disc		

Fuel - Pump To Carburetor Line			Impala	
Part No.	Year	Description	O.E. Steel	Stainless Steel
IBC1004	1955-56	V8 - 2 & 4 Barrel (2 Pc.)		
IBC1008	1959-61	348 CID - 3-2 Barrel (3 Pc.) - Tri-Power		
IBC1009	1963	427 CID - Z-11 - Holley (3 Pc.)		
CAC1001	1967-70	250 CID 155 HP 1 Barrel Carburetor		
CAC1012	1969	427 CID 335 HP Quadrajete Carburetor (3 Pc.)		
IBC1012	1973-77	350 CID - 2 Barrel and 4 Barrel		

Fuel - Tank To Pump Line			Impala	
Part No.	Year	Description	O.E. Steel	Stainless Steel
IBF1006	1958	V8 - Set - Inside Frame - 3/8" (3 Pc.)		
IBF1009	1959-61	V8 - 5/16"		
IBF1008	1959-62	V8 - Set - Inside Frame - 3/8" (3 Pc.)		
IBF1011	1963-64	V8 - Set - 3/8" (3 Pc.)		
IBF1012	1965	5/16"		
IBF1013	1965	3/8"		
IBF1014	1967-68	5/16"		
IBF1015	1967-68	3/8"		
IBF1030	1969	Hardtop (5/16")		
IBF1018	1971-76	Convertible		
IBF1019	1974-76	Hardtop		
BUF1037	2000-05	3.8 Liter V6		



## CHEVROLET

### Fuel - Return Line Impala

Part No.	Year	Description	O.E. Steel	Stainless Steel
IBR1007	1962	Return		
IBR1002	1971-76	Convertible		
IBR1010	1971-76	Hardtop		
IBR1005	1989	Fuel - Rail Injection Line 305 CID		
IBR1006	1991-96	SS V8 Throttle Body Return		
BUR1019	2000-05	3.8 Liter V6		

### Fuel - Vapor Line Impala

Part No.	Year	Description	O.E. Steel	Stainless Steel
IBV1003	1971-76	Hardtop		
BUV1007	2000-05	3.8 Liter V6		

### Fuel - Vent Line Impala

Part No.	Year	Description	O.E. Steel	Stainless Steel
IBV1008	1965	Hardtop - Fuel Vent		
IBV1001	1965-66	2 Door - Tank Vent Line - U-Shaped - 5/16"		
IBV1002	1965-66	4 Door - Tank Vent Line - U-Shaped - 5/16"		
IBV1005	1968	Tank Vent Line		

### Transmission Lines (Sold In Pairs) Impala

Part No.	Year	Description	O.E. Steel	Stainless Steel
IBT1004	1958-60	Powerglide		
IBT1005	1958-60	Turboglide		
IBT1006	1961-62	Powerglide		
IBT1013	1963-64	Powerglide		
IBT1007	1965-66	T-400		
IBT1011	1965-66	Powerglide		
IBT1008	1967	Powerglide & T-350		
IBT1012	1968	T-400		
IBT1009	1973-76	T-350 And T-400		
IBT1016	1991-95	External Cooler (4 Pc.)		
IBT1015	1996	SS (5 Pc.) - W/External Cooler		

### Transmission Modulator Line Impala

Part No.	Year	Description	O.E. Steel	Stainless Steel
IBM1001	1965	Powerglide - V8 - 283 CID		
IBM1002	1966	T-400		
IBM1003	1967	Powerglide		
IBM1004	1975			

### Miscellaneous & Other Lines Impala

Part No.	Year	Description	O.E. Steel	Stainless Steel
IBO1007	1963	409 CID With A/C - Power Steering Line		
IBO1003	1974	Brake Booster Vacuum Line		
IBO1006	1978-85	305 CID - 2 Barrel - Brake Booster Vacuum Line		

### CAMARO

### Complete Brake Line Kit Camaro

Part No.	Year	Description	O.E. Steel	Stainless Steel
CA1001	1967	Standard Drum (1 Pc. Front to Rear)		
CA1002	1967	Power Drum (1 Pc. Front to Rear)		
CA1004	1967	Standard Disc (2 Pc. Front to Rear)		
CA1005	1967	Power Disc (1 Pc. Front to Rear)		
CA1006	1967	Power Disc (2 Pc. Front to Rear)		
CA1007	1967	Standard Drum (2 Pc. Front to Rear)		
CA1008	1967	Power Drum (2 Pc. Front to Rear)		
CA1009	1967	Standard Disc (1 Pc. Front to Rear)		
CA1001	1968	Standard Drum - Mono Leaf Spring (1 Pc. Front to Rear)		
CA1002	1968	Power Drum - Mono Leaf Spring (1 Pc. Front to Rear)		
CA1003	1968	Standard Disc - Multi Leaf Springs (1 Pc. Front to Rear)		
CA1004	1968	Standard Disc - Mono Leaf Spring (2 Pc. Front to Rear)		
CA1005	1968	Power Disc - Mono Leaf Spring (1 Pc. Front to Rear)		
CA1006	1968	Power Disc - Mono Leaf Spring (2 Pc. Front to Rear)		
CA1007	1968	Standard Drum - Mono-Leaf Spring (2 Pc. Front to Rear)		
CA1008	1968	Power Drum - Mono-Leaf Spring (2 Pc. Front to Rear)		
CA1009	1968	Standard Disc - Mono-Leaf Spring (1 Pc. Front to Rear)		
CA1030	1968	Standard Drum - Multi-Leaf Spring (1 Pc. Front to Rear)		
CA1031	1968	Power Drum - Multi-Leaf Spring (1 Pc. Front to Rear)		
CA1033	1968	Standard Disc - Multi-Leaf Spring (2 Pc. Front to Rear)		
CA1034	1968	Power Disc - Multi-Leaf Spring (1 Pc. Front to Rear)		
CA1035	1968	Power Disc - Multi-Leaf Spring (2 Pc. Front to Rear)		
CA1066	1968	Standard Drum - Multi Leaf Spring (2 Pc. Front to Rear)		
CA1067	1968	Power Drum - Multi Leaf Spring (2 Pc. Front to Rear)		
CA1013	1969	Standard Drum - (1 Pc. Front to Rear)		
CA1014	1969	Power Drum (1 Pc. Front to Rear)		
CA1015	1969	Standard Disc (1 Pc. Front to Rear)		
CA1016	1969	Standard Disc - (2 Pc. Front to Rear)		
CA1017	1969	Power Disc (1 Pc. Front to Rear)		
CA1018	1969	Power Disc (2 Pc. Front to Rear)		
CA1019	1969	4 Wheel Power Disc (JL8) (1 Pc. Front to Rear)		
CA1062	1969	Standard Drum (with 2 Pc. Front to Rear)		
CA1063	1969	Power Drum (2 Pc. Front to Rear)		
CA1020	1970	Standard Disc		
CA1021	1970	Power Disc		
CA1024	1971-74	Standard Disc		
CA1025	1971-74	Power Disc		
CA1026	1975-80	Non Z28 - Standard Disc		
CA1027	1975-80	Non Z28 - Power Disc		
CA1038	1975-80	Z28 Only - Standard Disc		

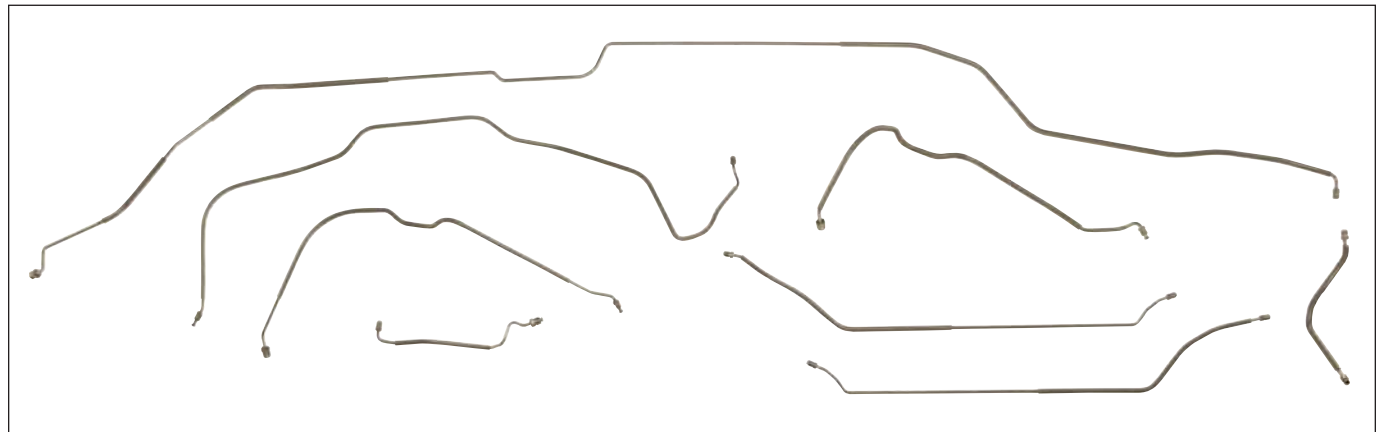

# CHEVROLET

CA1039	1975-80	Z28 Only - Power Disc
CA1041	1981	Non Z28 - Standard Disc
CA1042	1981	Non Z28 - Power Disc
CA1043	1981	Z28 Only - Standard Disc
CA1044	1981	Z28 Only - Power Disc
CA1045	1982-83	Power Disc - Rear Drum
CA1046	1982-83	Power Disc - Rear Disc
CA1047	1984-86	Power Disc - Rear Drum
CA1048	1984-86	Power Disc - Rear Disc
CA1049	1984-86	Power Disc - Rear Drum - 4 and 6 Cylinder
CA1053	1987-90	IROC With 7.75 Australian 9 Bolt Axle
CA1050	1987-92	Z28 Rear Disc - Non 7.75 Australian 9 Bolt Axle
CA1068	1987-92	Rear Drum Brakes - Inlet Lines Not Included, But Sold Separately
CA1054	1993-97	Rear Disc - Without Traction Control
CA1065	1995-97	With Traction Control - Inlet Lines Not Included, But Sold Separately
CA1052	1998-02	With Traction Control
CA1069	1998-02	Without Traction Control - Inlet Lines Not Included, But Sold Separately

Caliper Inlet Lines & Transfer Tubes (Sold in Pairs)				Camaro	
Part No.	Year	Description	O.E. Steel	Stainless Steel	
CAD1001	1967-68	Inlet Size: 3/8"			
CAD1003	1967-68	Inlet Size: 7/16" & 1/2"			
CAD1002	1969	4 Wheel - Power Disc JL-8 rear caliper inlet lines (2 pc.)			

Fuel - Pump To Carburetor Line				Camaro	
Part No.	Year	Description	O.E. Steel	Stainless Steel	
CAC1002	1967	283 CID 195 HP - 2 Barrel Carburetor (5/16")			
CAC1002	1967-68	327 CID 210 HP - 2 Barrel Carburetor (5/16")			
CAC1003	1967-68	327 CID 275HP Quadrajete Carburetor (5/16")			
CAC1005	1967-68	Z-28 - 302 CID Holley Carburetor (3 Pc.)			
CAC1006	1967-68	396 CID 325HP and 350HP Quadrajete Carburetor (1 Pc.)			
CAC1007	1967-68	396 CID 375HP Holley Carburetor (3 Pc.)			
CAC1001	1967-69	230 CID 140 HP 1 Barrel Carburetor			
CAC1004	1967-69	327 CID 275HP Quadrajete Carburetor (3/8")			
CAC1001	1967-70	250 CID 155 HP 1 Barrel Carburetor			
CAC1019	1968	327 CID 2 Barrel Carburetor (3/8")			
CAC1008	1969	350 CID - 255HP - Holley Carburetor (1 Pc.)			
CAC1009	1969	396 CID 375HP and 427 CID 425HP Holley Carburetor (3 Pc.)			
CAC1010	1969	350 CID 255HP and 300 HP Quadrajete Carburetor (3 Pc.)			
CAC1011	1969	307 CID and 327 CID and 350 CID 2 Barrel Carburetor			
CAC1012	1969	396 CID - 325HP and 350HP - Quadrajete Carburetor (3 Pc.)			
CAC1013	1969	Z-28 - 302 CID Holley Carburetor (3 Pc.)			
CAC1017	1969	307 CID 2 Barrel Carburetor (3/8")			
CAC1012	1970	396 CID 350HP - Quadrajete Carburetor (3 Pc.)			
CAC1013	1970-72	Z-28 - 350 CID Holley Carburetor (3 Pc.)			
CAC1014	1970-72	350 CID 300HP Quadrajete Carburetor (1 Pc.)			
CAC1015	1971-78	Z-28 - 350 CID Quadrajete Carburetor			
CAC1016	1971-82	350 CID Quadrajete Carburetor (1 Pc.)			
CAC1020	1982	Z-28 305 CID - TBI To Filter Line			
CAC1021	1982-83	2.8 Liter			
CAC1018	1984	Z-28 - 305 CID Quadrajete Carburetor			

Fuel - Tank To Pump Line				Camaro	
Part No.	Year	Description	O.E. Steel	Stainless Steel	
CAF1001	1967-68	Small Block - 5/16" (1 Pc.)			
CAF1002	1967-68	Small Block - 3/8" (1 Pc.)			
CAF1003	1967-68	Big Block - 3/8" (1 Pc.)			
CAF1004	1969	3/8" (1 Pc.)			
CAF1005	1969	6 Cylinder 5/16" (1 Pc.)			
CAF1006	1970-73	Small & Big Block - 3/8" (2 Pc.)			
CAF1007	1978-81	3/8" (2 Pc.)			
CAF1008	1982-83	V8			

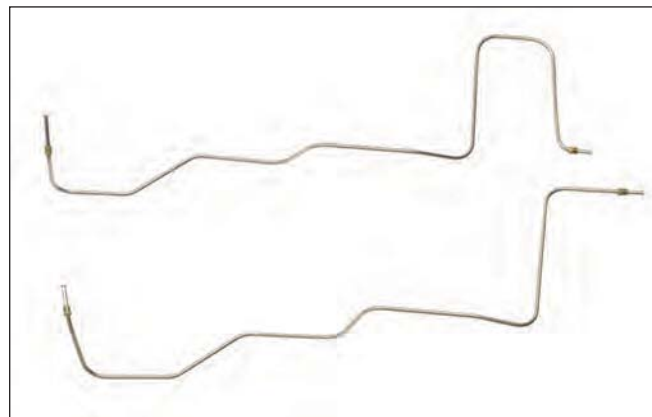

CAF1015	1982-83	V6
CAF1009	1984-86	V8 - Carbureted only
CAF1010	1986-89	V8 IROC Throttle Body - Fuel Injection
CAF1012	1990-91	Z-28 - Inlet Filter 3/8" (2 Pc.)
CAF1014	1996	V6

Fuel - Return Line				Camaro	
Part No.	Year	Description	O.E. Steel	Stainless Steel	
CAR1001	1969	1/4" (1 Pc.)			
CAR1002	1970-74	1/4" (2 Pc.)			
CAR1003	1975-81	1/4" (2 Pc.)			
CAR1004	1982-83	V8 - Carbureted			
CAR1008	1984-86	V8 Carbureted Motor			
CAR1005	1985-89	V8 TPI Motors			
CAR1006	1990-92	V8 - Z-28 5/16"			
CAR1007	1993-97	All Motors			

Fuel - Vapor Line				Camaro	
Part No.	Year	Description	O.E. Steel	Stainless Steel	
CAV1001	1970-73	Fuel - Tank to Canister - 5/16" (1 Pc.)			
CAV1002	1975-81	Tank to Canister - 5/16" (2 Pc.)			
CAV1004	1982-83	V8			
CAV1009	1982-83	V6			
CAV1005	1984-86	V8 - Carbureted			
CAV1006	1985-89	V8 TPI Motors			
CAV1007	1990-91	Z-28			
CAV1008	1993-97	All Motors			

Fuel - Stand Pipe Set				Camaro	
Part No.	Year	Description	O.E. Steel	Stainless Steel	
CAS1001	1970-74	(3 Pc.)			

Rubber Brake Hose				Camaro	
Part No.	Year	Description	O.E. Steel	Stainless Steel	
RH6345	2015-16	(4 Pc.)			

Transmission Lines (Sold In Pairs)				Camaro	
Part No.	Year	Description	O.E. Steel	Stainless Steel	
CAT1001	1967-69	Powerglide & T-350			
CAT1002	1967-69	T-400			
CAT1003	1970-74	T-400 - 1/2" Thread Radiator Inlet Ports			
CAT1004	1970-74	T-400 - 5/8" Thread Radiator Inlet Ports			
CAT1009	1970-74	T-350			
CAT1005	1975-81	T-350			
CAT1011	1982	T-350			
CAT1008	1982-87	700-R4			
CAT1012	1989-92	V8 - 700R4			

# CHEVROLET

**Transmission Modulator Line** **Camaro**

Part No.	Year	Description	O.E. Steel	Stainless Steel
CAM1001	1967-69	Powerglide & T-350		
CAM1002	1967-69	T-400		
CAM1003	1969-72	T-350 - Right Side Modulator		
CAM1004	1971-81	T-350		
CAM1006	1973	350 CID - T-400		

**Choke Tube** **Camaro**

Part No.	Year	Description	O.E. Steel	Stainless Steel
CAK1001	1978-79	Camaro - Z28		

**Miscellaneous & Other Lines** **Camaro**

Part No.	Year	Description	O.E. Steel	Stainless Steel
CAO1005	1969	350 CID Brake Booster Vacuum Line		
CAA1001	1970	350 CID L-48 - Distributor Vacuum Line		
CAO1003	1970	350 CID L-48 - Brake Booster Vacuum Line		
CAO1004	1973	350 CID - Power Steering Return Line		
CAO1002	1979	Z-28 - Power Steering Return Line		
CAO1007	1985-86	IROC - Power Steering Cooler Line Set (3 Pc.)		
CAO1006	1988	IROC 350 CID - Power Steering Cooler Line		

**CHEVELLE / MALIBU**

**Complete Brake Line Kit** **Chevelle / Malibu**

Part No.	Year	Description	O.E. Steel	Stainless Steel
CE1001	1964-65	Hardtop - Standard Drum		
CE1002	1964-65	Hardtop - Power Drum		
CE1003	1964-65	Convertible - Standard Drum (6 Pc.)		
CE1004	1964-65	Convertible - Power Drum (6 Pc.)		
CE1006	1965	Hardtop - Power Drum		
CE1009	1966	Hardtop - Small Block V8 and 6 Cylinder - Standard Drum		
CE1010	1966	Hardtop - Small Block V8 and 6 Cylinder - Power Drum		
CE1011	1966	Convertible - Small Block V8 and 6 Cylinder - Standard Drum		
CE1012	1966	Convertible - Small Block V8 and 6 Cylinder - Power Drum		
CE1055	1966	Hardtop - Big Block - Standard Drum		
CE1056	1966	Hardtop - Big Block - Power Drum		
CE1057	1966	Convertible - Big Block - Standard Drum		
CE1058	1966	Convertible - Big Block - Power Drum		
CE1013	1967	Hardtop - Small Block V8 and 6 Cylinder - Standard Drum		
CE1014	1967	Hardtop - Small Block V8 and 6 Cylinder - Power Drum		
CE1015	1967	Hardtop - Small Block V8 and 6 Cylinder - Standard Disc		
CE1016	1967	Hardtop - Small Block V8 and 6 Cylinder - Power Disc		
CE1017	1967	Convertible - Small Block V8 and 6 Cylinder - Standard Drum		
CE1018	1967	Convertible - Small Block V8 and 6 Cylinder - Power Drum		
CE1019	1967	Convertible - Small Block V8 and 6 Cylinder - Standard Disc		
CE1020	1967	Convertible - Small Block V8 and 6 Cylinder - Power Disc		
CE1059	1967	Hardtop - Big Block - Standard Drum		
CE1060	1967	Hardtop - Big Block - Power Drum (7 Pc.)		
CE1061	1967	Hardtop - Big Block - Standard Disc		
CE1062	1967	Hardtop - Big Block - Power Disc		

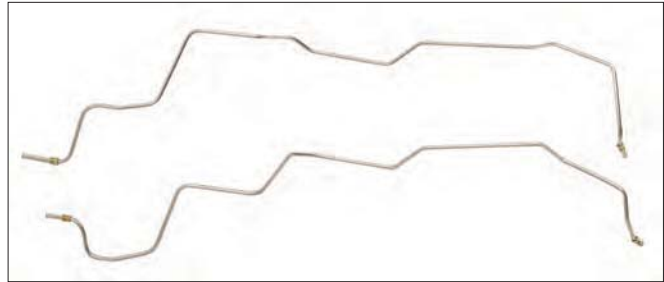

CE1063	1967	Convertible - Big Block - Standard Drum
CE1064	1967	Convertible - Big Block - Power Drum
CE1065	1967	Convertible - Big Block - Standard Disc
CE1066	1967	Convertible - Big Block - Power Disc
CE1029	1968-69	Hardtop - Standard Drum (7 Pc.)
CE1030	1968-69	Hardtop - Power Drum (7 Pc.)
CE1031	1968-69	Hardtop - Power Disc (8 Pc.)
CE1032	1968-69	Convertible - Standard Drum
CE1033	1968-69	Convertible - Power Drum
CE1034	1968-69	Convertible - Power Disc
CE1045	1970	Hardtop - Power Disc
CE1046	1970	Convertible - Power Disc
CE1047	1970-72	Hardtop - Standard Drum
CE1048	1970-72	Hardtop - Power Drum
CE1050	1970-72	Convertible - Standard Drum
CE1051	1970-72	Convertible - Power Drum
CE1049	1971-72	Hardtop - Power Disc
CE1052	1971-72	Convertible - Power Disc
CE1069	1971-72	Hardtop Standard Drum
CE1070	1971-72	Convertible Standard Drum
CE1071	1971-72	Hardtop Power Drum
CE1053	1973-77	Power Disc

**Caliper Inlet Lines & Transfer Tubes (Sold in Pairs)** **Chevelle / Malibu**

Part No.	Year	Description	O.E. Steel	Stainless Steel
CED1001	1967	Disc Caliper Inlet: 7/16" and 1/2" (2 Pc.)		
CED1002	1967	Disc Caliper Inlet: 3/8" and 3/8" (2 Pc.)		
CED1003	1968	Disc Caliper Inlet: 7/16" and 1/2" (2 Pc.)		
CED1004	1968	Disc Caliper Inlet: 3/8" and 3/8" (2 Pc.)		
CED1005	1968-72	Drum Inlet Lines (2 Pc.)		

**Fuel - Pump To Carburetor Line** **Chevelle / Malibu**

Part No.	Year	Description	O.E. Steel	Stainless Steel
CEC1001	1964	327 CID 300 HP 4 Barrel Carburetor		
CEC1002	1964	327 CID 250 HP 4 Barrel Carburetor		
CEC1003	1964-65	283 CID 195 HP 2 Barrel Carburetor		
CEC1005	1966	396 CID 325 HP and 350 HP - Holley Carburetor (1Pc.)		
CAC1003	1966-68	327 CID 275HP Quadrajjet Carburetor (5/16")		
CAC1007	1966-68	396 CID 375HP Holley Carburetor (3 Pc.)		
CAC1002	1967	283 CID 195 HP - 2 Barrel Carburetor (5/16")		
CEC1009	1967	396 CID 325HP and 350 HP Quadrajjet Carburetor		
CAC1001	1967-69	230 CID 140 HP 1 Barrel Carburetor		
CAC1004	1967-69	327 CID 275HP Quadrajjet Carburetor (3/8")		
CAC1001	1967-70	250 CID 155 HP 1 Barrel Carburetor		
CAC1006	1968	396 CID 325HP and 350HP Quadrajjet Carburetor (1 Pc.)		
CEC1014	1968-70	396 CID Quadrajjet Carburetor		
CAC1009	1969	396 CID 375HP and 427 CID 425HP Holley Carburetor (3 Pc.)		
CAC1010	1969	350 CID 255HP and 300 HP Quadrajjet Carburetor (3 Pc.)		
CAC1012	1969	396 CID 325 HP and 350 HP Quadrajjet Carburetor (3 Pc.)		
CEC1015	1969	350 CID 255 HP 4 Barrel Carburetor (1 Pc.)		
CEC1017	1969	307 CID 2 Barrel Carburetor (5/16")		

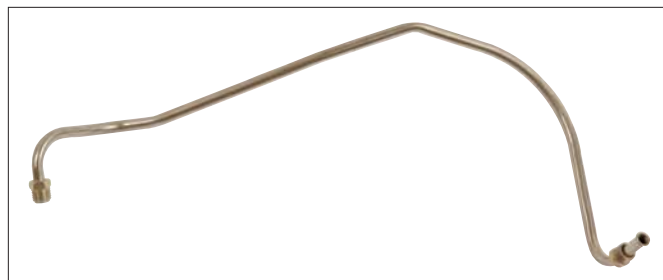

# CHEVROLET

CEC1020	1970	454 CID (LS5) 360HP and 402 CID (L34) 330 HP Quadrajete Carburetor W/ Long Fuel Pump
CEC1022	1970	350 CID 2 Barrel Carburetor
CEC1023	1970	454 CID 450HP (LS6) Holley Carburetor - Short Fuel Pump (3 Pc.)
CEC1024	1970	454 CID 450HP (LS6) Holley Carburetor - Long Fuel Pump (3 Pc.)
CEC1025	1971-72	350 CID - 270HP - Quadrajete Carburetor
CEC1026	1971-72	396 CID Quadrajete Carburetor
CEC1027	1971-72	402 CID Quadrajete Carburetor
CEC1029	1973-77	350 CID Quadrajete Carburetor
CEC1028	1975-77	307 CID & 350 CID - 2GC Carburetor

**Fuel - Tank To Pump Line** **Chevelle / Malibu**

Part No.	Year	Description	O.E. Steel	Stainless Steel
CEF1001	1964-66	Hardtop - 5/16"		
CEF1002	1964-66	Hardtop - 3/8"		
CEF1003	1964-66	Convertible - 5/16"		
CEF1004	1964-66	Convertible - 3/8"		
CEF1005	1967	Hardtop - 5/16"		
CEF1006	1967	Hardtop - 3/8"		
CEF1007	1967	Convertible - 5/16"		
CEF1008	1967	Convertible - 3/8"		
CEF1009	1968-72	Hardtop - 5/16"		
CEF1010	1968-72	Hardtop - 3/8"		
CEF1011	1968-72	Convertible - 5/16"		
CEF1012	1968-72	Convertible - 3/8"		
MCF1003	1973-77	V8 - 3/8"		

**Fuel - Return Line** **Chevelle / Malibu**

Part No.	Year	Description	O.E. Steel	Stainless Steel
CER1001	1968-72	Hardtop - 1/4"		
CER1002	1968-72	Convertible - 1/4"		
MCR1003	1973-75			

**Fuel - Vapor Line** **Chevelle / Malibu**

Part No.	Year	Description	O.E. Steel	Stainless Steel
CEV1004	1970	Hardtop - 5/16"		
CEV1005	1970	Convertible - 5/16"		

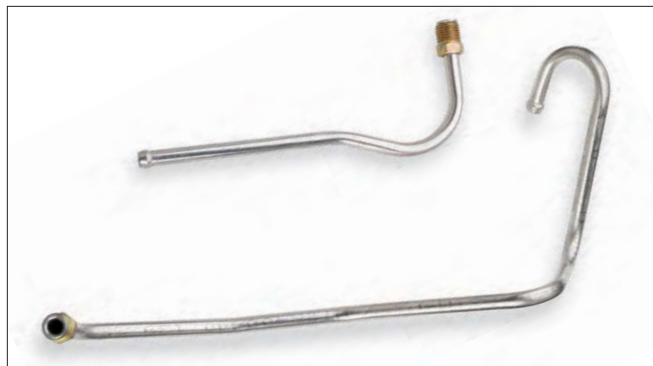

CEV1001	1971-72	Hardtop - 5/16"
CEV1002	1971-72	Convertible - 5/16"
MCV1003	1973-75	

**Fuel - Stand Pipe Set** **Chevelle / Malibu**

Part No.	Year	Description	O.E. Steel	Stainless Steel
CES1001	1970-72	(3 Pc.)		

**Fuel - Vent Line** **Chevelle / Malibu**

Part No.	Year	Description	O.E. Steel	Stainless Steel
CEV1006	1964	Hardtop - Filler Neck Vent		
CEV1003	1965-66	Filler Neck Vent		

**Transmission Lines (Sold In Pairs)** **Chevelle / Malibu**

Part No.	Year	Description	O.E. Steel	Stainless Steel
CET1001	1964-66	Powerglide		
CET1002	1967	T-400		
CET1003	1968-71	Powerglide & T-350		
CET1004	1968-71	T-400		
CET1006	1972	T-350 & Powerglide		
CET1007	1972	T-400		
CET1005	1973-77	T-350		

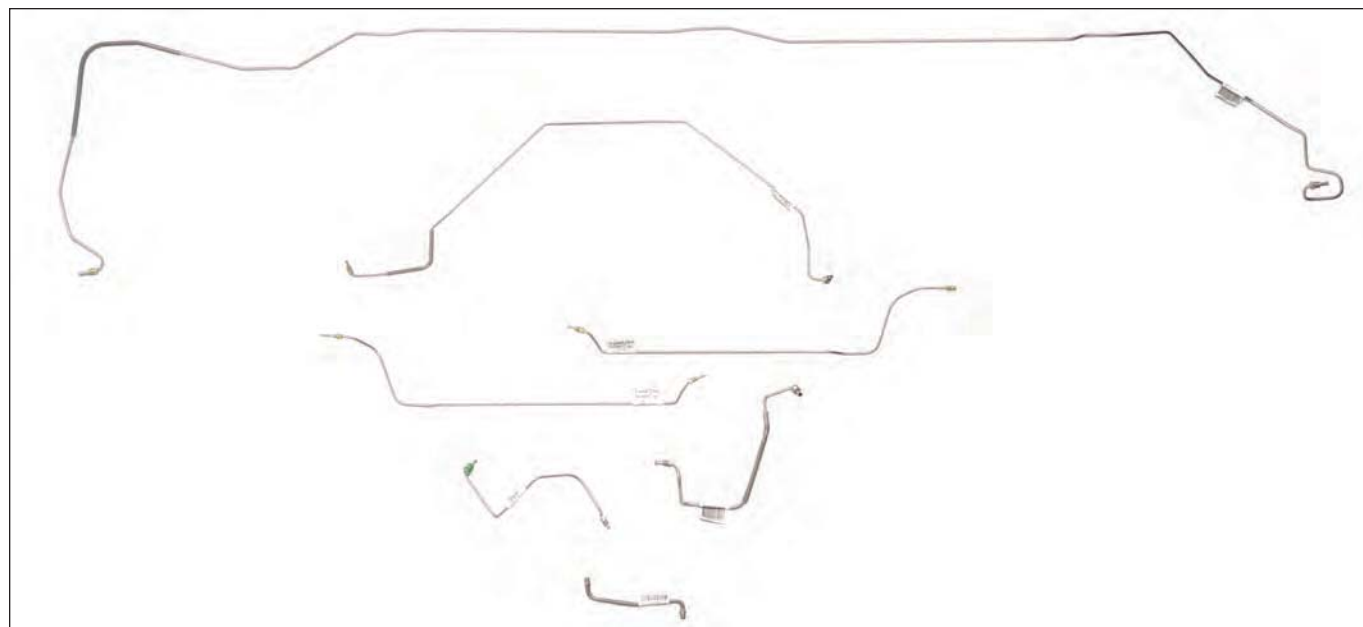

## CHEVROLET

Transmission Modulator Line			Chevelle / Malibu	
Part No.	Year	Description	O.E. Steel	Stainless Steel
CEM1003	1966	Big Block Powerglide w/Left Side Modulator		
CEM1005	1966	T-400		
CEM1006	1966	Powerglide		
CEM1001	1967-72	T-400		
CEM1002	1967-72	T-350 & Powerglide		
CEM1007	1978-81	T-350		

Miscellaneous & Other Lines			Chevelle / Malibu	
Part No.	Year	Description	O.E. Steel	Stainless Steel
CE01001	1964-66	Chevelle Distributor Vacuum Line - 327 CID		
CE01007	1964-66	Chevelle Choke Tube Set - 327 CID (2 Pc.)		
CE01005	1968-72	Chevelle Distributor Vacuum Line - Big Block - 4 Barrel		
CE01008	1971-72	Chevelle Brake Booster Vacuum Line - Big Block		
CE01009	1973-77	Chevelle Brake Booster Vacuum Line - Big Block		

### MALIBU 1978-PRESENT

Complete Brake Line Kit			Malibu 1978-present	
Part No.	Year	Description	O.E. Steel	Stainless Steel
CE1054	1978-81	Power Disc		
BU1029	1982-87	Power Disc		
CE1074	1998	4 Door		

Fuel - Tank To Pump Line			Malibu 1978-present	
Part No.	Year	Description	O.E. Steel	Stainless Steel
CEF1013	1978-87	3/8"		

Fuel - Return Line			Malibu 1978-present	
Part No.	Year	Description	O.E. Steel	Stainless Steel
MCR1002	1978-88			



Fuel - Vapor Line			Malibu 1978-present	
Part No.	Year	Description	O.E. Steel	Stainless Steel
BUV1005	1978-88	With A/C Only		
MCV1002	1978-88	Without AC		

Fuel - Stand Pipe Set			Malibu 1978-present	
Part No.	Year	Description	O.E. Steel	Stainless Steel
BUS1001	1978-86	(3 Pc.)		
MCS1003	1987-88	(3 Pc.)		

Transmission Lines (Sold In Pairs)			Malibu 1978-present	
Part No.	Year	Description	O.E. Steel	Stainless Steel
MCT1005	1978-85	T-350 - V8		
MCT1010	1986	200 R4		

Transmission Modulator Line			Malibu 1978-present	
Part No.	Year	Description	O.E. Steel	Stainless Steel
CEM1007	1980	T-350 267 CID 2 Barrel Carburetor		

### MONTE CARLO

Complete Brake Line Kit			Monte Carlo	
Part No.	Year	Description	O.E. Steel	Stainless Steel
MC1001	1970	Standard Drum		
MC1002	1970	Power Drum		
MC1003	1970	Power Disc - Front to Rear (2 Pc.)		
MC1004	1971-72	Power Disc		
MC1007	1971-72	Power Drum Front to Rear (1 Pc.)		
MC1008	1971-72	Standard Drum Front to Rear (1 Pc.)		
MC1005	1973-77	Power Disc		
MC1006	1978-81	Power Disc		
MC1009	1982-87	Power Disc		
MC1010	1997-01	With ABS - Rear Disc		
IB1063	2002-05	Front Disc Brakes		

Fuel - Pump To Carburetor Line			Monte Carlo	
Part No.	Year	Description	O.E. Steel	Stainless Steel
MCC1004	1970	350 CID - 2 Barrel		
MCC1005	1971-72	402 CID - Quadrajjet		
MCC1006	1971-72	350 CID - Quadrajjet - 270 HP		
CEC1029	1973-77	350 CID Quadrajjet Carburetor		
MCC1011	1974	454 CID - 4 Barrel		
MCC1008	1987	305 CID - Quadrajjet		
MCC1009	1988	305 CID - Quadrajjet		

Fuel - Tank To Pump Line			Monte Carlo	
Part No.	Year	Description	O.E. Steel	Stainless Steel
MCF1004	1970	3/8"		
MCF1001	1971-72	3/8"		
MCF1003	1973-77	V8 - 3/8"		
CEF1013	1978-87	3/8" (1 Pc.)		
BUF1037	2000-05	3.8 Liter V6		

Fuel - Return Line			Monte Carlo	
Part No.	Year	Description	O.E. Steel	Stainless Steel
MCR1004	1970			
MCR1001	1971-72	1/4"		
MCR1003	1973-77			
MCR1002	1978-88			
POR1008	1997-99	V6		
BUR1019	2000-05	3.8 Liter V6		

Fuel - Vapor Line			Monte Carlo	
Part No.	Year	Description	O.E. Steel	Stainless Steel
MCV1001	1971-72	5/16"		
MCV1003	1973-77			

# CHEVROLET

BUV1005	1978-88	With A/C Only
MCV1002	1978-88	Without AC
BUV1007	2000-05	3.8 Liter V6

Fuel - Stand Pipe Set			Monte Carlo	
Part No.	Year	Description	O.E. Steel	Stainless Steel
CES1001	1970-72	(3 Pc.)		
BUS1001	1978-83	(3 Pc.)		
MCS1003	1984-87	(3 Pc.)		

Fuel - Miscellaneous			Monte Carlo	
Part No.	Year	Description	O.E. Steel	Stainless Steel
POF1027	1997-99	V6 F.I. Feed Line		

Transmission Lines (Sold In Pairs)			Monte Carlo	
Part No.	Year	Description	O.E. Steel	Stainless Steel
MCT1001	1970-71	T-400 - Big Block		
MCT1007	1970-71	T-350 - T-400		
MCT1003	1972	T-350 - T-400		
MCT1004	1973-77	T-350 - T-400		
MCT1005	1978-85	T-350 - V8		
MCT1011	1984	T-350		
MCT1010	1986	200 R4		
MCT1009	1987-88	LS V8 - 200 4R Transmission		

Miscellaneous & Other Lines			Monte Carlo	
Part No.	Year	Description	O.E. Steel	Stainless Steel
MCO1002	1972	Booster Vacuum Line		
IBO1006	1976-79	Brake Booster - 350 CID		
MCO1001	1986	Power Steering Supply Line		



## EL CAMINO

Complete Brake Line Kit			El Camino	
Part No.	Year	Description	O.E. Steel	Stainless Steel
EL1020	1959	Standard Drum		
IB1065	1959-60	Standard Brake		
IB1066	1959-60	Power Brake		
CE1003	1964-65	Standard Drum Front Brakes (6 Pc.)		
CE1004	1964-65	Power Drum Front Brakes (6 Pc.)		

CE1011	1966	Small Block And 6 Cylinder - Standard Drum
CE1012	1966	Small Block And 6 Cylinder - Power Drum
CE1017	1967	Standard Drum - Small Block And 6 Cylinder
CE1018	1967	Power Drum - Small Block And 6 Cylinder
CE1019	1967	Standard Disc - Small Block And 6 Cylinder
CE1020	1967	Power Disc - Small Block And 6 Cylinder
CE1063	1967	Big Block - Standard Drum
CE1064	1967	Big Block - Power Drum
CE1065	1967	Big Block - Standard Disc

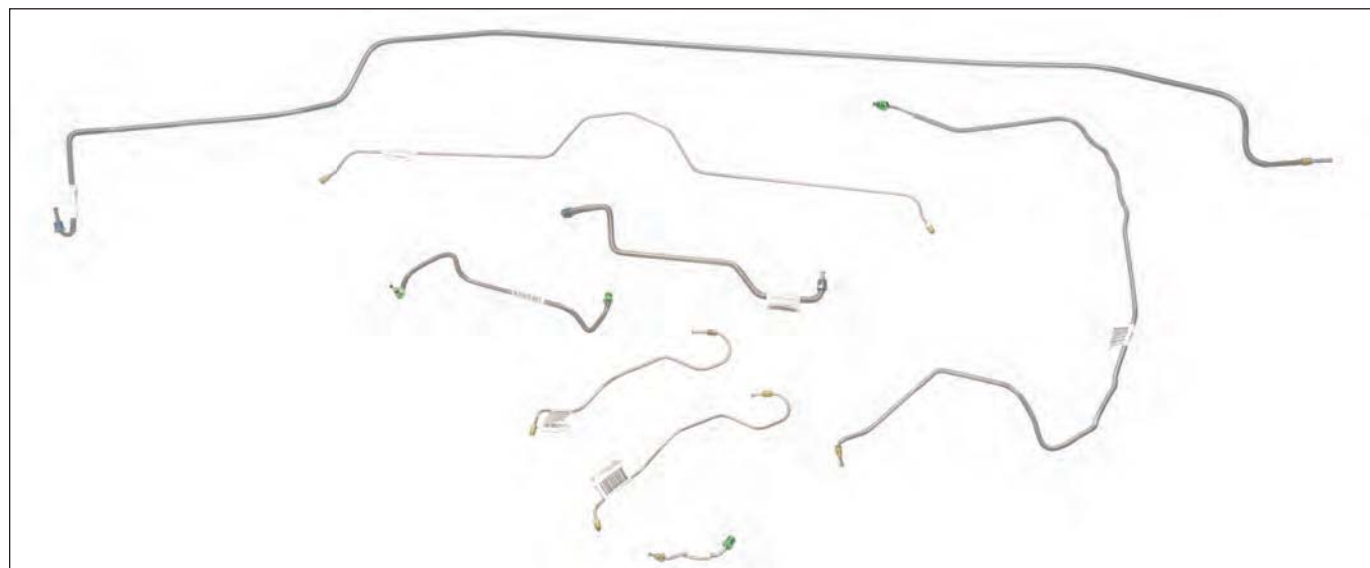

# CHEVROLET

Cont. from previous page

CE1066	1967	Big Block - Power Disc
EL1011	1968-69	Power Disc
EL1012	1968-69	Standard Drum
EL1013	1968-69	Power Drum
EL1014	1970	Power Disc
EL1015	1970	Standard Drum
EL1016	1970	Power Drum
EL1017	1971-72	Power Disc
EL1024	1971-72	Power Drum
EL1025	1971-72	Standard Drum
EL1018	1973-77	Power Disc
EL1019	1978-87	Power Disc

**Fuel - Pump To Carburetor Line** **El Camino**

Part No.	Year	Description	O.E. Steel	Stainless Steel
CEC1001	1964	327 CID 4 Barrel 300 HP		
CEC1002	1964	327 CID 250 HP 4 Barrel		
IBC1010	1964	327 CID 4 Barrel 250 HP		
CEC1003	1965	283 2 Barrel		
CEC1005	1966	396 350/325 HP Holley (1Pc.)		
CAC1007	1966-68	396 CID 375HP Holley Carburetor (3 Pc.)		
CEC1009	1967	396 325/350 HP Quadrajete		
CAC1002	1967-68	327 CID & 283 CID- 210 HP - 2 Barrel 5/16"		
CAC1003	1967-68	327 CID - 275HP - 4 Barrel - Quadrajete - 5/16"		
CAC1001	1967-69	230 CID 140 HP 1 Barrel Carburetor		
CAC1004	1967-69	327 CID - 275HP - 4 Barrel - Quadrajete - 3/8"		
CAC1001	1967-70	250 CID 155 HP 1 Barrel Carburetor		
CEC1014	1968-70	396 CID - Quadrajete		
CAC1009	1969	396 CID 375HP Holley Carburetor (3 Pc.)		
CAC1010	1969	350 CID 255HP and 300 HP Quadrajete Carburetor (3 Pc.)		
CAC1012	1969	396 CID 325 HP and 350 HP Quadrajete Carburetor (3 Pc.)		
CEC1015	1969	350 CID 4 Barrel 255 HP (1 Pc.)		
CEC1017	1969	307 2 Barrel 5/16"		

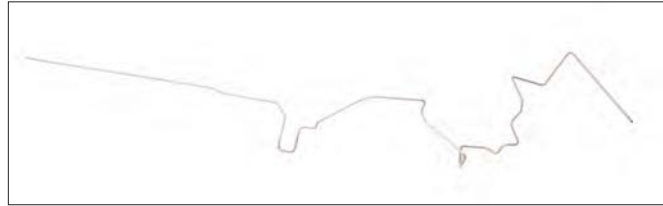

CEC1020	1970	LS5 L34 454 402 Quadrajete 325 HP w/ Long Fuel Pump
CEC1022	1970	350 2 Barrel
CEC1023	1970	454 450HP LS6 Holley - Short Fuel Pump (3 Pc.)
CEC1024	1970	454 LS6 Holley - Long Fuel Pump (3 Pc.)
CEC1025	1971-72	350 CID - 270 HP - 4 Barrel
CEC1026	1971-72	396 Quadrajete
CEC1027	1971-72	402 Quadrajete

**Fuel - Tank To Pump Line** **El Camino**

Part No.	Year	Description	O.E. Steel	Stainless Steel
CEF1003	1964-66	5/16"		
CEF1004	1964-66	3/8"		
CEF1007	1967	5/16"		
CEF1008	1967	3/8"		
ELF1001	1968-72	5/16"		
ELF1002	1968-72	3/8"		
ELF1003	1973-77	3/8"		
ELF1004	1978-87	3/8"		
ELF1005	1987	Fuel - Injected 4.3 Liter - V6 - (2 Pc.)		

**Fuel - Return Line** **El Camino**

Part No.	Year	Description	O.E. Steel	Stainless Steel
ELR1001	1968-72			
ELR1002	1973-77	1/4"		
ELR1003	1985	Fuel - Injected 4.3 Liter - V6		

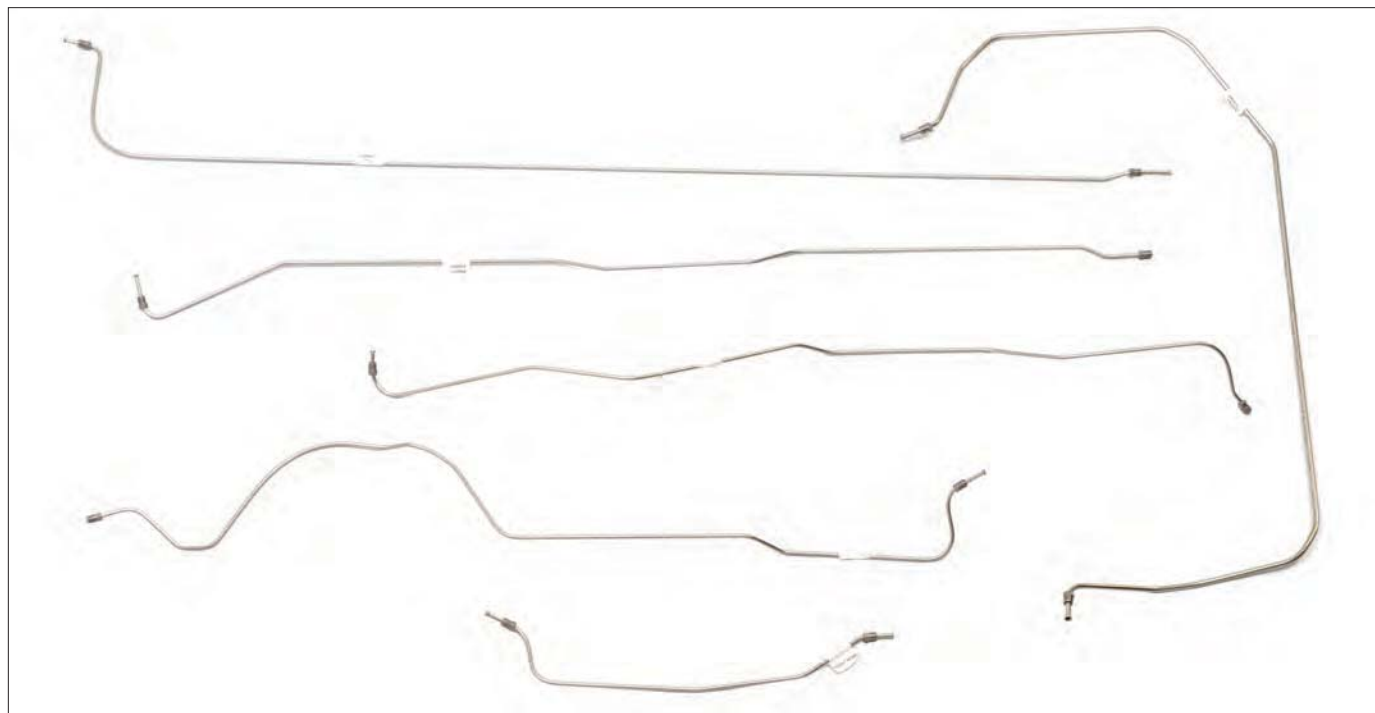

## CHEVROLET

### Fuel - Vapor Line El Camino

Part No.	Year	Description	O.E. Steel	Stainless Steel
ELV1004	1970			
ELV1001	1971-72			
ELV1002	1973-77	5/16"		
ELV1003	1978-87	5/16"		

### Fuel - Stand Pipe Set El Camino

Part No.	Year	Description	O.E. Steel	Stainless Steel
CES1001	1970-72	(3 Pc.)		
ELS1002	1978-87	305 Cid V8 (3 Pc.)		
ELS1001	1985	Fuel Injected 4.3 Liter - V6 (3 Pc.)		

### Transmission Lines (Sold In Pairs) El Camino

Part No.	Year	Description	O.E. Steel	Stainless Steel
CET1001	1964-66	Powerglide		
CET1002	1967	T-400		
CET1003	1968-71	Powerglide & T-350		
CET1004	1968-71	T-400		
CET1006	1972	T-350 & Powerglide		
CET1007	1972	T-400		
CET1005	1973-77	T-350		
MCT1005	1978-85	T-350 - V8		
MCT1010	1986	200 R4		

### Transmission Modulator Line El Camino

Part No.	Year	Description	O.E. Steel	Stainless Steel
CEM1003	1966	Big Block Powerglide w/ Left Side Modulator		
CEM1005	1966	T-400		
CEM1006	1966	Powerglide		
CEM1001	1967-72	T-400		
CEM1002	1967-72	T-350 & Powerglide		

### Miscellaneous & Other Lines El Camino

Part No.	Year	Description	O.E. Steel	Stainless Steel
CHO1005	1964-67	283 CID 220 H.P. 4 Barrel Distributor Vacuum Line		
CEO1010	1966-67	427 CID 390HP & 396 CID 350HP - 4 Barrel Holley - Distributor Vacuum Line		
CEO1003	1968-70	327 & 350 CID Rochester Quadrajet Carburetor Distributor Vacuum Line		
CEO1011	1968-72	Air Shock Lines (3 Pc.)		
MCO1002	1971	Booster Vacuum Line		
ELO1001	1979	Power Steering Feed & Return Lines (2 Pc.)		

## NOVA / CHEVY II

### Complete Brake Line Kit Nova / Chevy II

Part No.	Year	Description	O.E. Steel	Stainless Steel
NV1001	1962-63	Drum Brake - All		
NV1002	1964-65	Drum Brake - All		
NV1003	1966	Drum Brake - Except L-79		
NV1004	1966	L-79 Only		
NV1005	1967	Standard Drum		
NV1009	1968	Standard Drum		
NV1010	1968	Power Drum		
NV1011	1968	Standard Disc		
NV1012	1968	Power Disc		
NV1029	1968	Standard Drum - Multi Leaf Spring		
NV1030	1968	Power Drum - Multi Leaf Spring		
NV1031	1968	Standard Disc - Multi Leaf Spring		
NV1032	1968	Power Disc - Multi Leaf Spring		
NV1013	1969	Standard Drum		
NV1014	1969	Power Drum		
NV1015	1969	Standard Disc		
NV1016	1969	Power Disc		
NV1017	1970	Standard Drum		

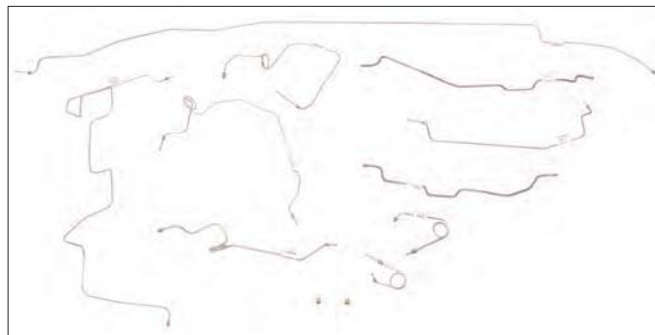

NV1018	1970	Power Drum
NV1019	1970	Standard Disc
NV1020	1970	Power Disc
NV1021	1971-74	Standard Drum
NV1022	1971-74	Power Drum
NV1023	1971-74	Standard Disc
NV1024	1971-74	Power Disc
NV1027	1975-78	Standard Disc
NV1028	1975-78	Power Disc

### Fuel - Pump To Carburetor Line Nova / Chevy II

Part No.	Year	Description	O.E. Steel	Stainless Steel
NVC1001	1962-64	6 Cylinder - 194 CID - Quadrajet (1 Pc.)		
IBC1013	1965-66	Nova 283 - 2 Barrel - 5/16"		
CAC1002	1967-68	327 CID & 283 CID - 210 HP - 2 Barrel 5/16"		
CAC1003	1967-68	327 CID - 275HP - 4 Barrel - Quadrajet - 5/16"		
CAC1006	1967-68	396-325/350 HP Quadrajet (1 Pc.)		
CAC1006	1967-68	Nova 396 CID 325HP and 350HP Quadrajet Carburetor (1 Pc.)		
CAC1004	1967-69	327 CID - 275HP - 4 Barrel - Quadrajet - 3/8"		
NVC1004	1967-70	6 Cylinder - 230 CID & 250 CID - 1 Barrel & 2 Barrel		
CAC1008	1969	350 CID - 255HP - Holley (1 Pc.)		
CAC1009	1969	396 CID - 375HP - Holley (3 Pc.)		
CAC1012	1969-70	396 CID - 325/350HP - Quadrajet (3 Pc.) - W/ Return Line		
NVC1016	1971-74	6 Cylinder		
CEC1028	1975-79	307 CID & 350 CID 2 Barrel Quadrajet		

### Fuel - Tank To Pump Line Nova / Chevy II

Part No.	Year	Description	O.E. Steel	Stainless Steel
NVF1001	1962-67	4 Cylinder and 6 Cylinder		
NVF1002	1964-67	V8		
NVF1004	1968-69	3/8" (2 Pc.)		
NVF1007	1968-69	5/16" (2 Pc.)		
NVF1003	1970-74	5/16" (2 Pc.)		

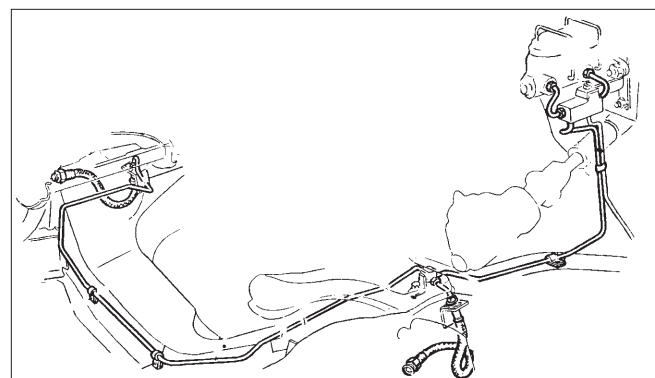

## CHEVROLET

Cont. from previous page

NVF1005	1970-74	3/8" (2 Pc.)
NVF1008	1975-79	V8

Fuel - Return Line			Nova / Chevy II	
Part No.	Year	Description	O.E. Steel	Stainless Steel
NVR1002	1969	(2 Pc.)		
NVR1001	1970-74	(2 Pc.) 1/4"		

Fuel - Vapor Line			Nova / Chevy II	
Part No.	Year	Description	O.E. Steel	Stainless Steel
NWV1001	1970-74			
NWV1003	1972	Nova Only - 6 Cylinder - Vapor Line Set (4 Pc.)		
NWV1002	1975-79			

Transmission Lines (Sold In Pairs)			Nova / Chevy II	
Part No.	Year	Description	O.E. Steel	Stainless Steel
NVT1002	1968-71	Powerglide & T-350 - V8		
NVT1005	1968-72	Powerglide - 6 Cylinder		
NVT1003	1968-74	6 Cylinder - 3 Speed		
NVT1004	1972-74	T-350 - V8		
NVT1006	1975-78	T-350 - 6 Cylinder		

Transmission Modulator Line			Nova / Chevy II	
Part No.	Year	Description	O.E. Steel	Stainless Steel
NVM1001	1970	Nova T-350		

Miscellaneous & Other Lines			Nova / Chevy II	
Part No.	Year	Description	O.E. Steel	Stainless Steel
CHO1003	1963-65	327/300HP and 327/350-365HP Holley Carburetor - Distributor Vacuum Line		
NV01004	1963-67	6 Cylinder - 194 CID - Distributor Vacuum Line		
CHO1005	1965-68	283 CID 220 H.P. 4 Barrel Distributor Vacuum Line		
NV01001	1973	350 CID - Power Steering Return Line		
NV01003	1975-79	Brake Booster Vacuum Line		

## CORVETTE

Complete Brake Line Kit			Corvette	
Part No.	Year	Description	O.E. Steel	Stainless Steel
CV1001	1954-55	Manual Brakes		
CV1003	1956-62	Manual Brakes		
CV1004	1963-64	Standard Drum - Brakes - Front to Rear - Top of Frame		
CV1005	1963-64	Power Drum Brakes - Front to Rear - Top of Frame		
CV1006	1965	Standard Brake - Front to Rear - 3/16"		
CV1027	1965	Power Disc - Early - Front to Rear - 3/16" - Bottom of Frame		
CV1010	1965-66	Power Disc - Front to Rear - 1/4" Dual Master Cylinder - late 1965		
CV1009	1966	Standard Brake - Front to Rear 1/4" - Single Master Cylinder		
CV1022	1966	J-56 Brake		
CV1011	1967	Standard Disc		
CV1014	1967	J-56 Brake Option		
CV1012	1967-68	Power Disc		
CV1013	1968	Standard Disc		
CV1015	1969	Standard Disc		
CV1016	1969	Power Disc		
CV1017	1970-73	Manual Disc		
CV1018	1970-73	Power Disc		
CV1019	1974-82	Standard Disc		
CV1020	1974-82	Power Disc		
CV1029	1984-85	(6 Pc.)		
CV1021	1987	(9 Pc.)		
CV1028	1988-91	(9 Pc.)		
CV1032	1992-93	ABS (8 Pc.)		
CV1030	1994	ABS (8 Pc.)		
CV1033	1996	(8 Pc.)		

Fuel - Pump To Carburetor Line			Corvette	
Part No.	Year	Description	O.E. Steel	Stainless Steel
CVC1001	1954-55	Carburetor Line		
CVC1002	1956-58	283 CID 220 HP and 230 HP 4 Barrel Carburetor		
CVC1003	1956-58	265/283 - 2-4V (3 Pc.)		

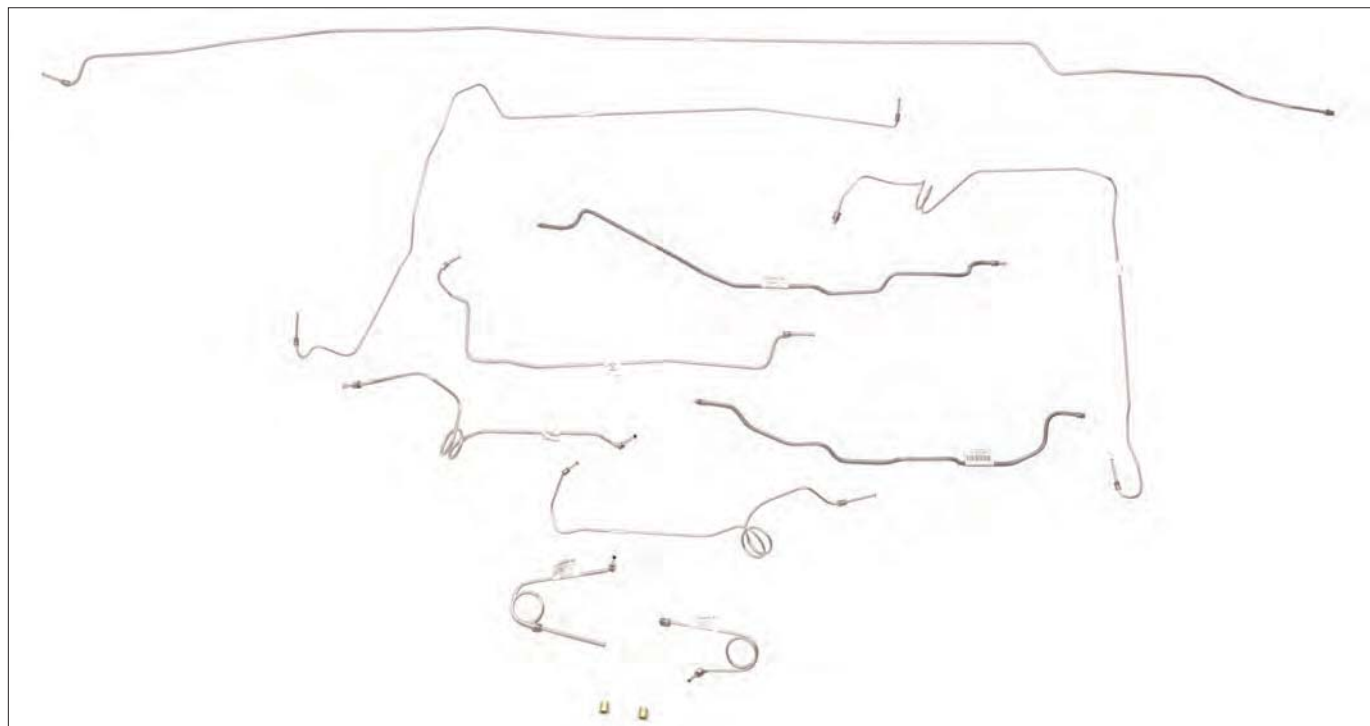

# CHEVROLET

CVC1004	1957	283 CID With Fuel Injection - Pump To Filter
CVC1005	1957-58	283 CID With Fuel Injection - Filter To Motor
CVC1006	1958	283 CID With Fuel Injection - Pump To Filter
CVC1008	1959-61	283 CID With Fuel Injection - Pump To Filter
CVC1009	1959-61	283 w/ 2-4V (3 Pc.)
CVC1010	1959-62	283 CID - 230/250 HP - 4 Barrel
CVC1011	1962	327 CID With Fuel Injection
CVC1012	1962	327/300 - 340 HP - 4 Barrel (1 Pc.)
CVC1013	1963-65	327/300 and 340 HP (2 Pc.)
CVC1014	1963-65	327 CID With Fuel Injection (2 Pc.)
CVC1016	1963-65	327 CID 250 HP
CVC1018	1964-65	327 CID 350HP and 365 HP
CVC1019	1965	396 CID 425HP Holley Carburetor (3 Pc.)
CEC1005	1966	427 CID 390 HP - Holley Carburetor (1Pc.)
CVC1020	1966	327 CID 300 HP Holley Carburetor
CVC1021	1966	327 CID 350HP Holley Carburetor
CVC1023	1966	427 CID 425HP Holley Carburetor (3 Pc.)
CVC1024	1967	327 CID 350HP
CVC1025	1967	327 CID 300HP
CVC1026	1967	427 CID 390HP (1 Pc.)
CVC1027	1967	427/400-435 HP - 3-2V (5 Pc.)
CAC1007	1967-69	427 CID (L88) Holley Carburetor (3 Pc.)
CVC1029	1968-69	427 CID 390HP Quadrajct Carburetor With Inline Filter (3 Pc.)
CVC1030	1968-69	427/400-435 HP - 3-2V (5 Pc.)
CVC1031	1968-69	327/350 - Quadrajct - Inline - Filter W/Return Line (3 Pc.)
CVC1032	1970-72	350 CID (LT1) Holley Carburetor (3 Pc.)
CVC1034	1970-74	454 All Except Holley (1 Pc.)
CVC1037	1970-74	454 CID Quadrajct Carburetor With Air Pump
CVC1033	1970-76	350 CID - L48-L82
CVC1035	1971	454 w/ Special High Performance LS-6 - Long Fuel Pump (3 Pc.)
CVC1039	1972	LT1 With Air Conditioning - Holley Carburetor (3 pc.)
CVC1036	1977-81	350 CID With ArmorGuard
CVC1038	1984	TPI - Fuel Injected

Fuel - Tank To Pump Line			Corvette	
Part No.	Year	Description	O.E. Steel	Stainless Steel
CVF1001	1954-55	5/16" - (1 Pc.)		
CVF1002	1956	5/16" - (3 Pc.)		
CVF1003	1956-57	Inside Frame - 3/8" (3 Pc.)		
CVF1004	1958-60	Outside Frame - 3/8" (2 Pc.)		
CVF1005	1961-62	1 Fitting & 1 Hose End - 3/8" (2 Pc.)		
CVF1008	1963-67	Small Block		
CVF1009	1965-67	Big Block		
CVF1010	1968-69			
CVF1011	1970-74			
CVF1012	1975-77			
CVF1013	1978-82			
CVF1014	1984			
CVF1022	1985-87	Complete Line Set (2 Pc.)		
CVF1015	1987			
CVF1023	1988-91	Complete Line Set (2 Pc.)		
CVF1017	1989-90	Coupe and Convertible		
CVF1018	1992-93			

Fuel - Return Line			Corvette	
Part No.	Year	Description	O.E. Steel	Stainless Steel
CVR1001	1968-74	Right Side		
CVR1002	1975-77			
CVR1003	1978-82			
CVR1011	1982	Cross Fire Fuel Injected (5/16")		
CVR1004	1984			
CVR1010	1984	Fuel Rail Return Line		
CVR1014	1985-87	Complete Line Set (2 Pc.)		
CVR1012	1986			
CVR1009	1987			

CVR1006	1989-90	Coupe and Convertible
CVR1008	1989-90	Coupe and Convertible Fuel Rail Return Line
CVR1007	1992	

Fuel - Vapor Line			Corvette	
Part No.	Year	Description	O.E. Steel	Stainless Steel
CVW1001	1970-74	Left Side		
CVW1002	1975-77			
CVW1003	1978-82			
CVW1004	1984			
CVW1005	1986			

Fuel - Miscellaneous			Corvette	
Part No.	Year	Description	O.E. Steel	Stainless Steel
CVO1003	1962	Axle Vent Line		
CVO1004	1970	350 CID (L46) - Vacuum Advance Line (Carburetor to TCS Solenoid)		
CVO1005	1977	L-48 350 CID Brake Booster Vacuum Line		
CVO1002	1980	Vacuum Booster Line - 350 CID - Turbo Hydramatic 350 Transmission		
CVF1020	1984	Throttle Body Line		
CVO1001	1985	Rack and Pinion Power Steering Lines (2 Pc.)		
CVF1016	1987	Fuel - Rail Feed Line		
CVF1019	1989	Fuel - Rail Feed Line		

Transmission Lines (Sold In Pairs)			Corvette	
Part No.	Year	Description	O.E. Steel	Stainless Steel
CVT1002	1963-67	Powerglide - Small & Big Block		
CVT1003	1968-74	T-350 & T-400 - 327 CID 350 CID 427 CID Small Block Short Pump		
CVT1003	1968-74	T-400 454 CID		
CVT1005	1970-76	Small Block - Long Fuel Pump		
CVT1006	1977-80	T-350		
CVT1007	1981-82	T-350		
CVT1008	1982	700R4		
CVT1009	1990			

Transmission Modulator Line			Corvette	
Part No.	Year	Description	O.E. Steel	Stainless Steel
CVM1001	1962			
CVM1002	1963-67	Vacuum Modulator Line		
CVM1003	1966	327 CID - 300 HP (GM #3890546)		
CAM1004	1978	T-350 Transmission		
CVM1004	1980	350 CID - Turbo Hydramatic 350		

Hydraulic Clutch Line			Corvette	
Part No.	Year	Description	O.E. Steel	Stainless Steel
CVH1001	1984-85	Clutch Line		
CVH1002	1986-88	Clutch Line		
CVH1003	1989-90	Clutch Line		
CVH1004	1991-96	Clutch Line		

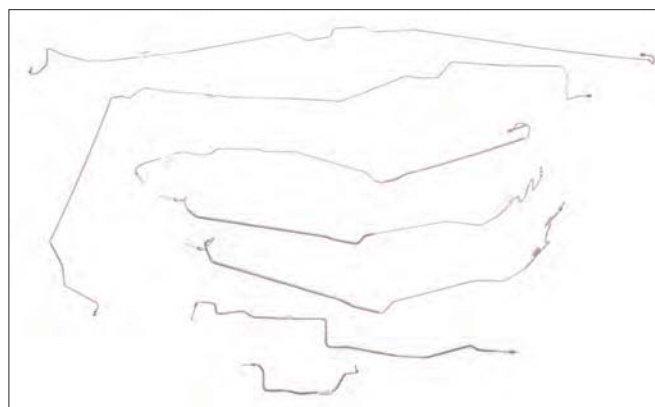

# CHEVROLET

**NOTE: PART NUMBERS ENDING IN RH INCLUDE ALL THE OEM RUBBER BRAKE HOSES.  
PART NUMBERS ENDING IN SB INCLUDE ALL STAINLESS STEEL BRAIDED STOPFLEX BRAKE HOSES.**

## CHEVROLET / GMC TRUCK

Complete Brake Line Kit				Chevrolet / GMC Truck	
Part No.	Year	Model	Description	O.E. Steel	Stainless Steel
CT1119	1936	1500	2WD		
CT1001	1941-42	3500			
CT1006	1941-42	1500	(1941-42)		
CT1036	1942	3500	1942		
CT1097	1944	3500	Military Vehicle (G506)		
CT1001	1946	3500	1946		
CT1006	1946	1500	1946		
CT1007	1946	2500	1946		
CT1002	1947-50	1500	(1947-50)		
CT1133	1950	3500	2WD Longbed 3800 Series		
CT1114	1951	1500	Model 3100		
CT1062	1952	1500	Model 3100		
CT1008	1953-54	2500	Suburban		
CT1082	1953-54	2500	(6 Pc.)		
CT1117	1953-54	1500	Model 3100		
CT1039	1955-57	1500	Shortbed - 2nd Series		
CT1043	1962	1500	2WD Shortbed		
CT1003	1963-65	1500	2WD Shortbed Standard Brake		
CT1146	1963-65	1500	2WD Shortbed Power Brake		
CT1147	1963-65	1500	2WD Longbed Standard Brake		
CT1148	1963-65	1500	2WD Longbed Power Brake		
CT1040	1966	1500	2WD Shortbed Standard Brake		
CT1143	1966	2500	2WD Longbed Power Brake		
CT1149	1966	1500	2WD Shortbed Power Brake		
CT1150	1966	1500	2WD Longbed Standard Brake		
CT1151	1966	1500	2WD Longbed Power Brake		
CT1152	1966	2500	2WD Longbed Standard Brake		
CT1017	1967-68	2500	2WD Longbed - Power Brake - Coil Springs		
CT1041	1967-68	2500	2WD Longbed - Standard Brake - Coil Springs		
CT1020	1969-70	1500	2WD Shortbed - Standard Brake Coil Springs		
CT1027	1969-70	1500	2WD Shortbed - Power Brake Coil Springs		
CT1029	1969-70	1500	2WD Longbed - Power Brake Coil Springs		
CT1032	1969-70	2500	2WD Longbed - Power Brake Leaf Springs		
CT1042	1969-70	1500	2WD Longbed - Standard Brake Coil Springs		
CT1092	1969-70	2500	4WD Longbed Power Drum		
CT1136	1969-70	2500	2WD Longbed Standard Brake Leaf Springs		
CT1153	1969-70	2500	4WD Longbed Standard Drum		
CT1005	1971-72	1500	2WD Shortbed - Power Disc - Leaf Springs		
CT1021	1971-72	1500	2WD Longbed - Power Disc - Leaf Springs		

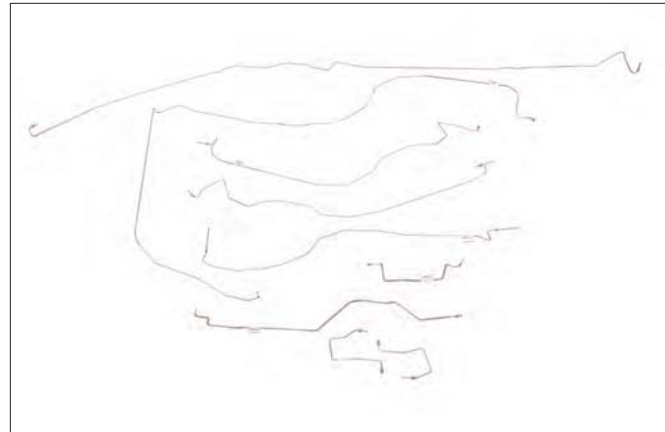

CT1023	1971-72	1500	4WD Shortbed - Power Disc - Leaf Springs
CT1024	1971-72	1500	2WD Longbed - Standard Disc - Leaf Springs
CT1030	1971-72	1500	2WD Shortbed Power Disc - Coil Springs
CT1031	1971-72	1500	2WD Longbed Power Disc - Coil Springs (3 pc.) Front to Rear
CT1035	1971-72	1500 Blazer	4WD Power Disc - Leaf Springs
CT1045	1971-72	1500	2WD Shortbed - Standard Disc - Coil Springs
CT1047	1971-72	1500	2WD Longbed Standard Disc - Coil Springs
CT1072	1971-72	2500	2WD Longbed - Power Disc - Leaf springs
CT1078	1971-72	2500	2WD Longbed Standard Disc - Leaf Springs
CT1080	1971-72	2500	4WD Longbed - Power Disc - Leaf Springs
CT1026	1973-75	1500	2WD Shortbed - Power Disc
CT1028	1973-75	1500	2WD Longbed - Power Disc
CT1154	1973-75	1500	2WD Standard Disc Longbed
CT1155	1973-75	1500	2WD Standard Disc Shortbed
CT1011	1976-80	1500	2WD Shortbed - Power Disc
CT1012	1976-80	1500	4WD Shortbed - Power Disc
CT1013	1976-80	1500	2WD Longbed - Power Disc
CT1014	1976-80	1500	4WD Longbed - Power Disc
CT1016	1976-80	1500 Blazer	4WD Power Disc
CT1053	1976-80	3500	2WD Crew Cab Longbed - Dual Rear Wheels - 1" Offset
CT1056	1976-80	3500	4WD Longbed - Power Disc - Dual Rear Wheel
CT1059	1976-80	2500	4WD Longbed - Power Disc
CT1156	1976-80	2500	2WD Longbed - Power Disc



# CHEVROLET

**NOTE: PART NUMBERS ENDING IN RH INCLUDE ALL THE OEM RUBBER BRAKE HOSES.  
 PART NUMBERS ENDING IN SB INCLUDE ALL STAINLESS STEEL BRAIDED STOPFLEX BRAKE HOSES.**

CT1061	1982-87	2500	4WD Longbed
CT1063	1982-87	2500	4WD W/ Load Sensor
CT1069	1982-87	1500	2WD Shortbed
CT1086	1982-87	2500	4WD Camper Special W/ Load Sensor and 5" Offset
CT1086	1982-87	3500	4WD Camper Special W/ Load Sensor and 5" Offset
CT1087	1982-87	2500	4WD W/ Load Sensor and 1" Offset
CT1087	1982-87	3500	4WD W/ Load Sensor and 1" Offset
CT1102	1982-87	1500	4WD Regular Cab Shortbed
CT1173	1982-87	2500	4WD Camper Special No Load Sensor 5" Offset
CT1173	1982-87	3500	4WD Camper Special No Load Sensor 5" Offset
CT1174	1982-87	2500	4WD Camper Special No Load Sensor 1" Offset
CT1174	1982-87	3500	4WD Camper Special No Load Sensor 1" Offset
CT1018	1982-90	S series S10	2WD Regular Cab Shortbed
CT1018	1982-90	S series Jimmy	2WD Regular Cab Shortbed
CT1218	1982-90	S series S10	2WD Power Disc Shortbed
CT1218	1982-90	S series Jimmy	2WD Power Disc Shortbed
CT1037	1983-87	1500	2WD Longbed
CT1051	1983-87	1500	4WD Longbed
CT1038	1983-90	S series S10	4WD
CT1038	1983-90	3500 Blazer	4WD
CT1157	1985-87	S series S10	4WD
CT1157	1985-87	S series Blazer	4WD
CT1065	1988-89	2500	4WD Regular Cab Longbed
CT1096	1988-89	1500	4WD Regular Cab Shortbed
CT1108	1988-89	1500	4WD Regular Cab Longbed Light Duty
CT1159	1988-89	1500 Heavy Duty	4WD Regular Cab Longbed
CT1130	1988-90	S series S10	4WD Extended Cab 4.3 Liter V6 ABS
CT1131	1988-90	S series S10	4WD Regular Cab 4.3 Liter V6 ABS
CT1179	1988-90	1500	2WD Regular Cab Longbed
CT1177	1990-91	Suburban	1500 4WD
CT1088	1991	1500 Blazer	Full Size - Rear ABS
CT1094	1991	1500 Syclone	1991
CT1219	1991-93	S series S10	2WD Power Disc Shortbed
CT1219	1991-93	S series Jimmy	2WD Power Disc Shortbed
CT1103	1992	Van Astro	2WD Not Extended
CT1122	1992-93	1500 Yukon	4WD
CT1067	1992-94	1500	4WD Extended Cab Short Bed
CT1083	1992-94	3500	4WD Regular Cab - Longbed
CT1095	1992-94	2500	4WD Regular Cab Longbed
CT1101	1992-94	1500	4WD Regular Cab Shortbed
CT1122	1992-94	1500 Blazer	4WD
CT1205	1992-94	1500	4WD Regular Cab Longbed

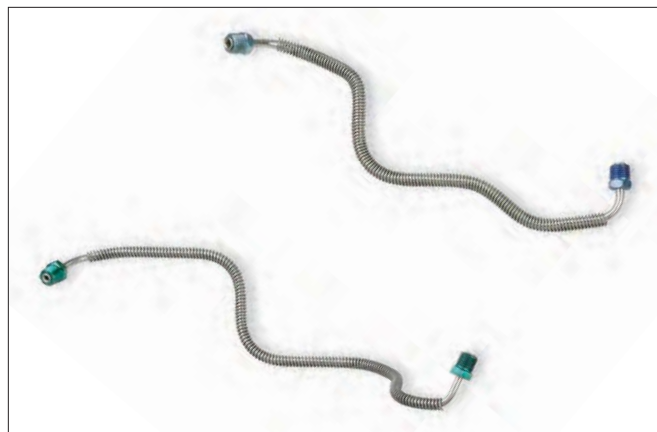

CT1178	1992-99	1500 Yukon XL	4WD
CT1178	1992-99	1500 Suburban	4WD
CT1122	1994	1500 Tahoe	4WD
CT1126	1994-95	S series S10	2WD Regular Cab Shortbed Non 4 Wheel ABS
CT1139	1994-97	S series S10	4WD W/ 4 wheel ABS Regular Cab Shortbed
CT1258	1994-97	S series S10	4WD W/ 4 wheel ABS Regular Cab Longbed
CT1066	1995-98	1500	4WD Regular Cab Longbed
CT1068	1995-98	2500	4WD Regular Cab Longbed
CT1068RH	1995-98	2500	4WD Regular Cab Longbed
CT1068SB	1995-98	2500	4WD Regular Cab Longbed
CT1085	1995-98	3500	4WD Regular Cab - Dual Rear Wheels
CT1099	1995-98	2500	4WD Extended Cab Longbed
CT1109	1995-98	1500	4WD Extended Cab Shortbed
CT1109RH	1995-98	1500	4WD Extended Cab Shortbed
CT1109SB	1995-98	1500	4WD Extended Cab Shortbed
CT1111	1995-98	2500	2WD Extended Cab Longbed
CT1120	1995-98	2500	2WD Regular Cab Longbed
CT1121	1995-98	1500	2WD Regular Cab Shortbed
CT1124	1995-98	2500	4WD Extended Cab W/ Dana Rear Axle
CT1135	1995-98	2500	4WD Regular Cab W/ Dana Rear Axle
CT1160	1995-98	1500	4WD Regular Cab Shortbed
CT1175	1995-98	1500	2WD Regular Cab Longbed
CT1184	1995-98	2500	4WD Extended Cab Shortbed
CT1199	1995-98	3500	4WD Regular Cab Longbed Single Rear Wheels
CT1105	1995-99	1500 Tahoe	4WD 4 Door W/ ABS
CT1105	1995-99	1500 Yukon	4WD 4 Door W/ ABS
CT1105RH	1995-99	1500 Tahoe	4WD 4 Door W/ ABS
CT1105SB	1995-99	1500 Tahoe	4WD 4 Door W/ ABS
CT1105RH	1995-99	1500 Yukon	4WD 4 Door W/ ABS
CT1105SB	1995-99	1500 Yukon	4WD 4 Door W/ ABS
CT1215	1995-99	2500 Suburban	4WD
CT1257	1995-99	1500 Yukon XL	4WD
CT1257	1995-99	1500 Suburban	4WD
CT1257RH	1995-99	1500 Yukon XL	4WD
CT1257RH	1995-99	1500 Suburban	4WD
CT1257SB	1995-99	1500 Yukon XL	4WD
CT1257SB	1995-99	1500 Suburban	4WD
CT1267	1995-99	1500 Tahoe	4WD 2 Door W/ ABS
CT1208	1996-97	S series S10	2WD Regular Cab Longbed Non 4 Wheel ABS
CT1216	1996-97	S series S10	2WD Regular Cab Shortbed - 4 Wheel ABS
CT1217	1996-97	S series S10	2WD Regular Cab Longbed - 4 Wheel ABS
CT1238	1996-97	S series S10	4WD Extended Cab Shortbed
CT1106	1997-05	Van G30	3500 Express Van - Short Wheelbase

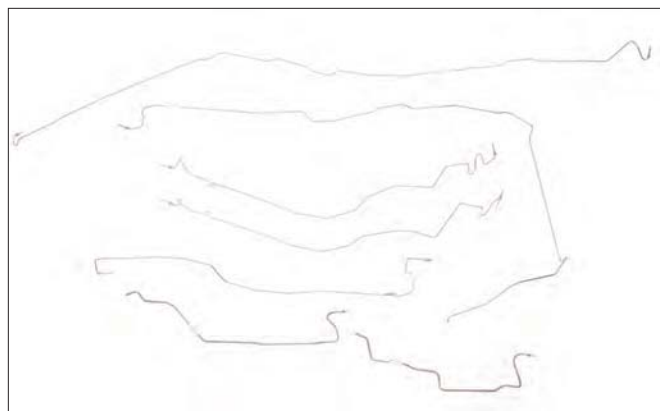

## CHEVROLET

NOTE: PART NUMBERS ENDING IN RH INCLUDE ALL THE OEM RUBBER BRAKE HOSES.  
PART NUMBERS ENDING IN SB INCLUDE ALL STAINLESS STEEL BRAIDED STOPFLEX BRAKE HOSES.

Cont. from previous page

CT1180	1997-05	Van G30	3500 Express Van - Long Wheelbase
CT1181	1997-05	Van G30	3500 Short Wheelbase - Dual Rear Wheels
CT1182	1997-05	1500	Van
CT1068	1999-00	2500	4WD Regular Cab Longbed (Old Body Style)
CT1068RH	1999-00	2500	4WD Regular Cab Longbed (Old Body Style)
CT1068SB	1999-00	2500	4WD Regular Cab Longbed (Old Body Style)
CT1099	1999-00	2500	4WD Extended Cab Longbed (Old Body Style)
CT1111	1999-00	2500	2WD Extended Cab Longbed (Old Body Style)
CT1118	1999-00	1500	2WD Regular Cab Longbed
CT1118RH	1999-00	1500	2WD Regular Cab Longbed
CT1118SB	1999-00	1500	2WD Regular Cab Longbed
CT1120	1999-00	2500	2WD Regular Cab Longbed (Old Body Style)
CT1124	1999-00	2500	4WD Extended Cab W/ Dana Rear Axle (Old Body Style)
CT1128	1999-00	1500	4WD Extended Cab Shortbed
CT1128RH	1999-00	1500	4WD Extended Cab Shortbed
CT1128SB	1999-00	1500	4WD Extended Cab Shortbed
CT1135	1999-00	2500	4WD Regular Cab W/ Dana Rear Axle (Old Body Style)
CT1140	1999-00	2500	4WD Extended Cab Shortbed (New Body Style)
CT1140RH	1999-00	2500	4WD Extended Cab Shortbed (New Body Style)
CT1140SB	1999-00	2500	4WD Extended Cab Shortbed (New Body Style)
CT1142	1999-00	3500	4WD Regular Cab Longbed Single Rear Wheels
CT1161	1999-00	2500	4WD Regular Cab Longbed (New Body Style)
CT1161RH	1999-00	2500	4WD Regular Cab Longbed (New Body Style)
CT1161SB	1999-00	2500	4WD Regular Cab Longbed (New Body Style)
CT1164	1999-00	1500	4WD Regular Cab Longbed
CT1164RH	1999-00	1500	4WD Regular Cab Longbed
CT1164SB	1999-00	1500	4WD Regular Cab Longbed
CT1169	1999-00	2500	4WD Extended Cab Longbed (New Body Style)
CT1169RH	1999-00	2500	4WD Extended Cab Longbed (New Body Style)
CT1169SB	1999-00	2500	4WD Extended Cab Longbed (New Body Style)
CT1184	1999-00	2500	4WD Extended Cab Shortbed (Old Body Style)
CT1187	1999-00	1500	4WD Regular Cab Shortbed
CT1187RH	1999-00	1500	4WD Regular Cab Shortbed
CT1187SB	1999-00	1500	4WD Regular Cab Shortbed
CT1192	1999-00	1500	4WD Extended Cab Longbed
CT1192RH	1999-00	1500	4WD Extended Cab Longbed
CT1192SB	1999-00	1500	4WD Extended Cab Longbed
CT1271	1999-00	2500	2WD Extended Cab - Shortbed
CT1271RH	1999-00	2500	2WD Extended Cab - Shortbed
CT1271SB	1999-00	2500	2WD Extended Cab - Shortbed
CT1294	1999-00	2500	2WD Regular Cab - Longbed
CT1294RH	1999-00	2500	2WD Regular Cab - Longbed
CT1294SB	1999-00	2500	2WD Regular Cab - Longbed
CT1295	1999-00	2500	2WD Extended Cab - Longbed
CT1295RH	1999-00	2500	2WD Extended Cab - Longbed
CT1295SB	1999-00	2500	2WD Extended Cab - Longbed

CT1296	1999-00	2500	2WD Crew Cab - Shortbed
CT1296RH	1999-00	2500	2WD Crew Cab - Shortbed
CT1296SB	1999-00	2500	2WD Crew Cab - Shortbed
CT1089	1999-01	1500	2WD Extended Cab Shortbed
CT1089RH	1999-01	1500	2WD Extended Cab Shortbed
CT1089SB	1999-01	1500	2WD Extended Cab Shortbed
CT1204	1999-01	2500	4WD Crew Cab Shortbed - Non Heavy Duty
CT1204RH	1999-01	2500	4WD Crew Cab Shortbed - Non Heavy Duty
CT1204SB	1999-01	2500	4WD Crew Cab Shortbed - Non Heavy Duty
CT1274	1999-01	1500	2WD Regular Cab Shortbed
CT1274RH	1999-01	1500	2WD Regular Cab Shortbed
CT1274SB	1999-01	1500	2WD Regular Cab Shortbed
CT1275	1999-01	1500	2WD Extended Cab Longbed
CT1275RH	1999-01	1500	2WD Extended Cab Longbed
CT1275SB	1999-01	1500	2WD Extended Cab Longbed
CT1172	2000-01	1500 Tahoe	4WD
CT1172RH	2000-01	1500 Tahoe	4WD
CT1172SB	2000-01	1500 Tahoe	4WD
CT1214	2000-01	1500 Yukon XL	4WD
CT1214	2000-01	1500 Suburban	4WD
CT1214RH	2000-01	1500 Yukon XL	4WD
CT1214RH	2000-01	1500 Suburban	4WD
CT1214SB	2000-01	1500 Yukon XL	4WD
CT1214SB	2000-01	1500 Suburban	4WD
CT1183	2001	3500	4WD Dual Rear Wheels
CT1226	2001	S series S10	4WD Crew Cab Shortbed W/ Rear Disc
CT1259	2001	S series S10	4WD Extended Cab Longbed W/ Rear Disc Brakes
CT1260	2001	S series S10	2WD Extended Cab Longbed W/ Rear Disc Brakes
CT1264	2001	S series S10	4WD Crew Cab Shortbed W/ Rear Drum Brakes
CT1265	2001	S series S10	4WD Extended Cab Longbed W/ Rear Drum Brakes
CT1266	2001	S series S10	2WD Extended Cab Longbed W/ Rear Drum Brakes
CT1127	2001-02	1500	4WD Regular Cab Shortbed
CT1127RH	2001-02	1500	4WD Regular Cab Shortbed
CT1127SB	2001-02	1500	4WD Regular Cab Shortbed
CT1138	2001-02	2500 Heavy Duty	4WD Regular Cab Longbed
CT1138RH	2001-02	2500 Heavy Duty	4WD Regular Cab Longbed
CT1138SB	2001-02	2500 Heavy Duty	4WD Regular Cab Longbed
CT1144	2001-02	2500 Heavy Duty	4WD Extended Cab Shortbed (144" Wheelbase)
CT1144RH	2001-02	2500 Heavy Duty	4WD Extended Cab Shortbed (144" Wheelbase)
CT1144SB	2001-02	2500 Heavy Duty	4WD Extended Cab Shortbed (144" Wheelbase)
CT1158	2001-02	1500	2WD and 4WD Crew Cab Shortbed HD
CT1158RH	2001-02	1500	2WD and 4WD Crew Cab Shortbed HD
CT1158SB	2001-02	1500	2WD and 4WD Crew Cab Shortbed HD
CT1166	2001-02	1500	4WD Regular Cab Longbed JC5 Brake Code
CT1166RH	2001-02	1500	4WD Regular Cab Longbed JC5 Brake Code
CT1166SB	2001-02	1500	4WD Regular Cab Longbed JC5 Brake Code
CT1186	2001-02	2500 Heavy Duty	4WD Extended Cab Longbed
CT1186RH	2001-02	2500 Heavy Duty	4WD Extended Cab Longbed
CT1186SB	2001-02	2500 Heavy Duty	4WD Extended Cab Longbed
CT1188	2001-02	1500	4WD Extended Cab Shortbed
CT1188RH	2001-02	1500	4WD Extended Cab Shortbed
CT1188SB	2001-02	1500	4WD Extended Cab Shortbed
CT1193	2001-02	1500	4WD Extended Cab Longbed
CT1193RH	2001-02	1500	4WD Extended Cab Longbed
CT1193SB	2001-02	1500	4WD Extended Cab Longbed
CT1198	2001-02	2500 Suburban	4WD
CT1198RH	2001-02	2500 Suburban	4WD
CT1198SB	2001-02	2500 Suburban	4WD
CT1198	2001-02	2500 Yukon XL	4WD
CT1198RH	2001-02	2500 Yukon XL	4WD
CT1198SB	2001-02	2500 Yukon XL	4WD

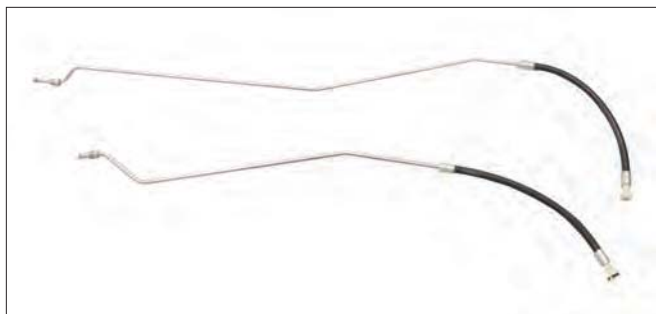

# CHEVROLET

**NOTE: PART NUMBERS ENDING IN RH INCLUDE ALL THE OEM RUBBER BRAKE HOSES.  
PART NUMBERS ENDING IN SB INCLUDE ALL STAINLESS STEEL BRAIDED STOPFLEX BRAKE HOSES.**



CT1201	2001-02	2500 Heavy Duty	4WD Crew Cab Shortbed
CT1201RH	2001-02	2500 Heavy Duty	4WD Crew Cab Shortbed
CT1201SB	2001-02	2500 Heavy Duty	4WD Crew Cab Shortbed
CT1221	2001-02	1500	4WD Crew Cab Shortbed
CT1241	2001-02	2500 Heavy Duty	4WD Regular Cab Longbed W/ QuadraSteer
CT1243	2001-02	2500 Heavy Duty	4WD Extended Cab Shortbed (144" Wheelbase) W/ QuadraSteer
CT1245	2001-02	2500 Heavy Duty	4WD Extended Cab Longbed W/ QuadraSteer
CT1247	2001-02	2500 Heavy Duty	4WD Crew Cab Shortbed W/ QuadraSteer
CT1254	2001-02	2500 Heavy Duty	4WD Crew Cab Longbed
CT1254RH	2001-02	2500 Heavy Duty	4WD Crew Cab Longbed
CT1254SB	2001-02	2500 Heavy Duty	4WD Crew Cab Longbed
CT1255	2001-02	3500	2WD Regular Cab Longbed - Dual Rear Wheels
CT1270	2001-02	3500 Crew Cab	4WD Dual Rear Wheels Longbed
CT1270RH	2001-02	3500 Crew Cab	4WD Dual Rear Wheels Longbed
CT1270SB	2001-02	3500 Crew Cab	4WD Dual Rear Wheels Longbed
CT1158	2002	2500	4WD Crew Cab Shortbed - Non Heavy Duty
CT1158RH	2002	2500	4WD Crew Cab Shortbed - Non Heavy Duty
CT1158SB	2002	2500	4WD Crew Cab Shortbed - Non Heavy Duty
CT1170	2002	1500 Suburban	4WD
CT1170RH	2002	1500 Suburban	4WD
CT1170SB	2002	1500 Suburban	4WD
CT1170	2002	1500 Yukon XL	4WD
CT1170RH	2002	1500 Yukon XL	4WD
CT1170SB	2002	1500 Yukon XL	4WD
CT1170	2002	1500 Avalanche	4WD
CT1170RH	2002	1500 Avalanche	4WD
CT1170SB	2002	1500 Avalanche	4WD
CT1189	2002	1500 Yukon	4WD
CT1189RH	2002	1500 Yukon	4WD
CT1189SB	2002	1500 Yukon	4WD
CT1189	2002	1500 Tahoe	4WD
CT1189RH	2002	1500 Tahoe	4WD
CT1189SB	2002	1500 Tahoe	4WD
CT1198	2002	2500 Avalanche	4WD
CT1198RH	2002	2500 Avalanche	4WD
CT1198SB	2002	2500 Avalanche	4WD
CT1200	2002	2500	4WD Extended Cab Shortbed - Non Heavy Duty

CT1200RH	2002	2500	4WD Extended Cab Shortbed - Non Heavy Duty
CT1200SB	2002	2500	4WD Extended Cab Shortbed - Non Heavy Duty
CT1223	2002	1500	2WD Extended Cab Shortbed
CT1224	2002	1500	2WD Regular Cab Longbed
CT1228	2002	1500	4WD Extended Cab Shortbed W/ QuadraSteer
CT1239	2002	1500 Yukon XL	4WD W/ QuadraSteer
CT1239	2002	1500 Denali	4WD W/ QuadraSteer
CT1240	2002	2500 Suburban	4WD W/ QuadraSteer
CT1263	2002	S series S10	4WD Extended Cab Longbed
CT1276	2002	1500	2WD Regular Cab Shortbed
CT1276RH	2002	1500	2WD Regular Cab Shortbed
CT1276SB	2002	1500	2WD Regular Cab Shortbed
CT1277	2002	1500	2WD Extended Cab Longbed
CT1277RH	2002	1500	2WD Extended Cab Longbed
CT1277SB	2002	1500	2WD Extended Cab Longbed
CT1288	2002	1500	4WD Extended Cab Longbed W/ QuadraSteer
CT1288RH	2002	1500	4WD Extended Cab Longbed W/ QuadraSteer
CT1288SB	2002	1500	4WD Extended Cab Longbed W/ QuadraSteer
CT1290	2002	1500	2WD Extended Cab Shortbed W/ QuadraSteer
CT1290RH	2002	1500	2WD Extended Cab Shortbed W/ QuadraSteer
CT1290SB	2002	1500	2WD Extended Cab Shortbed W/ QuadraSteer
CT1292	2002	1500	2WD Extended Cab Longbed W/ QuadraSteer
CT1292RH	2002	1500	2WD Extended Cab Longbed W/ QuadraSteer
CT1292SB	2002	1500	2WD Extended Cab Longbed W/ QuadraSteer
CT1261	2002-03	S series S10	4WD Crew Cab Shortbed
CT1262	2002-03	S series S10	2WD Crew Cab Shortbed
CT1194	2003	1500	4WD Regular Cab - Shortbed
CT1194RH	2003	1500	4WD Regular Cab - Shortbed
CT1194SB	2003	1500	4WD Regular Cab - Shortbed
CT1196	2003	1500	4WD- Extended Cab Longbed
CT1209	2003	1500	2WD Regular Cab Longbed
CT1227	2003	S series S10	2WD Extended Cab Longbed
CT1244	2003	2500	4WD Extended Cab Shortbed HD - W/ QuadraSteer
CT1269	2003	2500 Suburban	4WD
CT1269	2003	2500 Yukon XL	4WD
CT1185	2003-04	1500	4WD Regular Cab Longbed
CT1185RH	2003-04	1500	4WD Regular Cab Longbed
CT1185SB	2003-04	1500	4WD Regular Cab Longbed

# CHEVROLET

**NOTE: PART NUMBERS ENDING IN RH INCLUDE ALL THE OEM RUBBER BRAKE HOSES.  
PART NUMBERS ENDING IN SB INCLUDE ALL STAINLESS STEEL BRAIDED STOPFLEX BRAKE HOSES.**

Cont. from previous page

CT1190	2003-04	1500 Suburban	4WD
CT1190	2003-04	1500 Yukon XL	4WD
CT1190	2003-04	1500 Avalanche	4WD
CT1190RH	2003-04	1500 Suburban	4WD
CT1190RH	2003-04	1500 Yukon XL	4WD
CT1190RH	2003-04	1500 Avalanche	4WD
CT1190SB	2003-04	1500 Suburban	4WD
CT1190SB	2003-04	1500 Yukon XL	4WD
CT1190SB	2003-04	1500 Avalanche	4WD
CT1195	2003-04	1500	4WD Extended Cab Shortbed
CT1195RH	2003-04	1500	4WD Extended Cab Shortbed
CT1195SB	2003-04	1500	4WD Extended Cab Shortbed
CT1213	2003-04	1500 Tahoe	4WD
CT1213RH	2003-04	1500 Tahoe	4WD
CT1213SB	2003-04	1500 Tahoe	4WD
CT1213	2003-04	1500 Yukon	4WD
CT1213RH	2003-04	1500 Yukon	4WD
CT1213SB	2003-04	1500 Yukon	4WD
CT1220	2003-04	1500	2WD Extended Cab Shortbed
CT1220RH	2003-04	1500	2WD Extended Cab Shortbed
CT1220SB	2003-04	1500	2WD Extended Cab Shortbed
CT1222	2003-04	1500	4WD Crew Cab Shortbed
CT1229	2003-04	1500	4WD Extended Cab Shortbed W/ QuadraSteer
CT1278	2003-04	1500	2WD Regular Cab Shortbed
CT1278RH	2003-04	1500	2WD Regular Cab Shortbed
CT1278SB	2003-04	1500	2WD Regular Cab Shortbed
CT1279	2003-04	1500	2WD Extended Cab Longbed
CT1279RH	2003-04	1500	2WD Extended Cab Longbed
CT1279SB	2003-04	1500	2WD Extended Cab Longbed
CT1289	2003-04	1500	4WD Extended Cab Longbed W/ QuadraSteer
CT1289RH	2003-04	1500	4WD Extended Cab Longbed W/ QuadraSteer
CT1289SB	2003-04	1500	4WD Extended Cab Longbed W/ QuadraSteer
CT1291	2003-04	1500	2WD Extended Cab Shortbed W/ QuadraSteer
CT1291RH	2003-04	1500	2WD Extended Cab Shortbed W/ QuadraSteer
CT1291SB	2003-04	1500	2WD Extended Cab Shortbed W/ QuadraSteer
CT1293	2003-04	1500	2WD Extended Cab Longbed W/ QuadraSteer
CT1293RH	2003-04	1500	2WD Extended Cab Longbed W/ QuadraSteer
CT1293SB	2003-04	1500	2WD Extended Cab Longbed W/ QuadraSteer
CT1301	2003-04	1500 Suburban	4WD W/ AWD ESC Active Brake System
CT1301	2003-04	1500 Avalanche	4WD W/ AWD ESC Active Brake System
CT1301	2003-04	1500 Yukon XL	4WD W/ AWD ESC Active Brake System
CT1301RH	2003-04	1500 Suburban	4WD W/ AWD ESC Active Brake System
CT1301RH	2003-04	1500 Avalanche	4WD W/ AWD ESC Active Brake System
CT1301RH	2003-04	1500 Yukon XL	4WD W/ AWD ESC Active Brake System
CT1301SB	2003-04	1500 Suburban	4WD W/ AWD ESC Active Brake System



CT1301SB	2003-04	1500 Avalanche	4WD W/ AWD ESC Active Brake System
CT1301SB	2003-04	1500 Yukon XL	4WD W/ AWD ESC Active Brake System
CT1242	2003-05	2500 Heavy Duty	4WD Extended Cab Longbed W/ QuadraSteer
CT1244	2003-05	2500 Heavy Duty	2 WD & 4WD Extended Cab Shortbed W/ QuadraSteer
CT1246	2003-05	2500 Heavy Duty	4WD Regular Cab Longbed W/ QuadraSteer
CT1248	2003-05	2500 Heavy Duty	4WD Crew Cab Shortbed W/ QuadraSteer
CT1141	2003-06	2500 Heavy Duty	4WD Extended Cab Longbed
CT1141RH	2003-06	2500 Heavy Duty	4WD Extended Cab Longbed
CT1141SB	2003-06	2500 Heavy Duty	4WD Extended Cab Longbed
CT1176	2003-06	2500 Heavy Duty	4WD Extended Cab Shortbed
CT1176RH	2003-06	2500 Heavy Duty	4WD Extended Cab Shortbed
CT1176SB	2003-06	2500 Heavy Duty	4WD Extended Cab Shortbed
CT1197	2003-06	2500 Heavy Duty	4WD Regular Cab Longbed
CT1197RH	2003-06	2500 Heavy Duty	4WD Regular Cab Longbed
CT1197SB	2003-06	2500 Heavy Duty	4WD Regular Cab Longbed
CT1203	2003-06	2500 Heavy Duty	4WD Crew Cab Shortbed
CT1203RH	2003-06	2500 Heavy Duty	4WD Crew Cab Shortbed
CT1203SB	2003-06	2500 Heavy Duty	4WD Crew Cab Shortbed
CT1212	2003-06	2500 Heavy Duty	4WD Crew Cab Longbed
CT1212RH	2003-06	2500 Heavy Duty	4WD Crew Cab Longbed
CT1212SB	2003-06	2500 Heavy Duty	4WD Crew Cab Longbed
CT1302	2003-06	3500	Extended Cab Longbed W/ Dual Rear Wheels
CT1211	2005	3500	4WD Regular Cab Flatbed Dual Rear Wheels
CT1230	2005	1500	4WD Regular Cab Shortbed
CT1231	2005	1500	4WD Extended Cab Shortbed
CT1231RH	2005	1500	4WD Extended Cab Shortbed
CT1231SB	2005	1500	4WD Extended Cab Shortbed
CT1232	2005	1500	4WD Regular Cab Longbed
CT1232RH	2005	1500	4WD Regular Cab Longbed
CT1232SB	2005	1500	4WD Regular Cab Longbed
CT1233	2005	1500	4WD Crew Cab Shortbed
CT1256	2005	1500	4WD Extended Cab Longbed

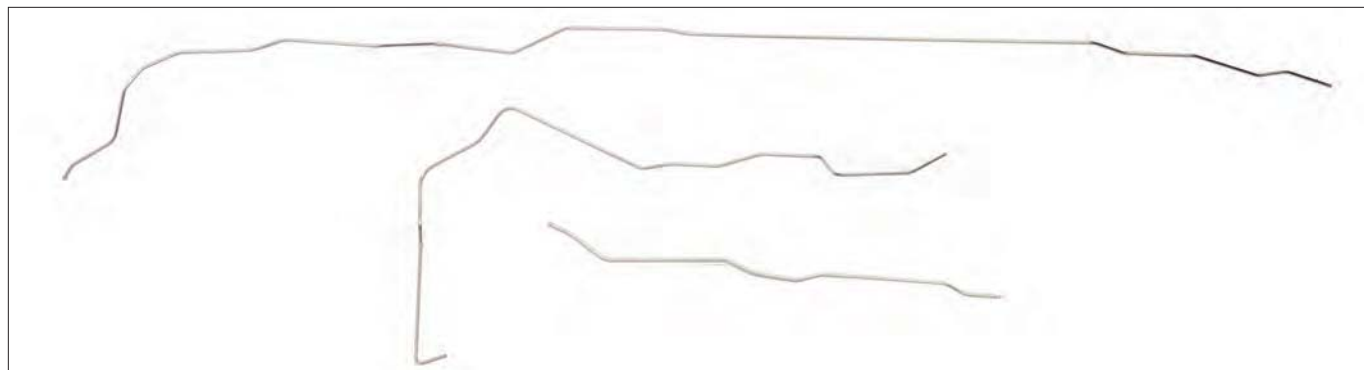

# CHEVROLET

**NOTE: PART NUMBERS ENDING IN RH INCLUDE ALL THE OEM RUBBER BRAKE HOSES.  
PART NUMBERS ENDING IN SB INCLUDE ALL STAINLESS STEEL BRAIDED STOPFLEX BRAKE HOSES.**

CT1256RH	2005	1500	4WD Extended Cab Longbed
CT1256SB	2005	1500	4WD Extended Cab Longbed
CT1280	2005	1500	2WD Regular Cab Shortbed W/ Flexible Hoses in Master Cylinder Lines
CT1280RH	2005	1500	2WD Regular Cab Shortbed W/ Flexible Hoses in Master Cylinder Lines
CT1280SB	2005	1500	2WD Regular Cab Shortbed W/ Flexible Hoses in Master Cylinder Lines
CT1281	2005	1500	2WD Regular Cab Longbed W/ Flexible Hoses in Master Cylinder Lines
CT1281RH	2005	1500	2WD Regular Cab Longbed W/ Flexible Hoses in Master Cylinder Lines
CT1281SB	2005	1500	2WD Regular Cab Longbed W/ Flexible Hoses in Master Cylinder Lines
CT1282	2005	1500	2WD Extended Cab Shortbed W/ Flexible Hoses in Master Cylinder Lines
CT1282RH	2005	1500	2WD Extended Cab Shortbed W/ Flexible Hoses in Master Cylinder Lines
CT1282SB	2005	1500	2WD Extended Cab Shortbed W/ Flexible Hoses in Master Cylinder Lines
CT1283	2005	1500	2WD Extended Cab Longbed W/ Flexible Hoses in Master Cylinder Lines
CT1283RH	2005	1500	2WD Extended Cab Longbed W/ Flexible Hoses in Master Cylinder Lines
CT1283SB	2005	1500	2WD Extended Cab Longbed W/ Flexible Hoses in Master Cylinder Lines
CT1250	2005-06	1500 Yukon XL	4WD - W/ AWD ESC Active Brake System
CT1250RH	2005-06	1500 Yukon XL	4WD - W/ AWD ESC Active Brake System
CT1250SB	2005-06	1500 Yukon XL	4WD - W/ AWD ESC Active Brake System
CT1250	2005-06	1500 Suburban	4WD - W/ AWD ESC Active Brake System
CT1250RH	2005-06	1500 Suburban	4WD - W/ AWD ESC Active Brake System
CT1250SB	2005-06	1500 Suburban	4WD - W/ AWD ESC Active Brake System
CT1250	2005-06	1500 Avalanche	4WD - W/ AWD ESC Active Brake System
CT1250RH	2005-06	1500 Avalanche	4WD - W/ AWD ESC Active Brake System
CT1250SB	2005-06	1500 Avalanche	4WD - W/ AWD ESC Active Brake System
CT1273	2005-07	1500	2WD Extended Cab Longbed
CT1273RH	2005-07	1500	2WD Extended Cab Longbed
CT1273SB	2005-07	1500	2WD Extended Cab Longbed
CT1284	2005-07	1500	2WD Regular Cab Shortbed
CT1284RH	2005-07	1500	2WD Regular Cab Shortbed
CT1284SB	2005-07	1500	2WD Regular Cab Shortbed
CT1285	2005-07	1500	2WD Regular Cab Longbed
CT1285RH	2005-07	1500	2WD Regular Cab Longbed
CT1285SB	2005-07	1500	2WD Regular Cab Longbed
CT1286	2005-07	1500	2WD Extended Cab Shortbed
CT1286RH	2005-07	1500	2WD Extended Cab Shortbed
CT1286SB	2005-07	1500	2WD Extended Cab Shortbed
CT1287	2005-07	1500	4WD Extended Cab Longbed
CT1287RH	2005-07	1500	4WD Extended Cab Longbed
CT1287SB	2005-07	1500	4WD Extended Cab Longbed
CT1297	2005-07	1500	4WD Extended Cab - Standard Bed
CT1297RH	2005-07	1500	4WD Extended Cab - Standard Bed
CT1297SB	2005-07	1500	4WD Extended Cab - Standard Bed
CT1235	2006	1500	4WD Extended Cab Shortbed
CT1235RH	2006	1500	4WD Extended Cab Shortbed
CT1235SB	2006	1500	4WD Extended Cab Shortbed
CT1236	2006	1500	4WD Regular Cab Longbed
CT1237	2006	1500	4WD Crew Cab Shortbed
CT1237RH	2006	1500	4WD Crew Cab Shortbed
CT1237SB	2006	1500	4WD Crew Cab Shortbed
CT1234	2006-07	1500	4WD Regular Cab Shortbed
CT1234RH	2006-07	1500	4WD Regular Cab Shortbed
CT1234SB	2006-07	1500	4WD Regular Cab Shortbed
CT1298	2006-07	1500	4WD Regular Cab - Longbed (Has solid master cylinder lines)
CT1298RH	2006-07	1500	4WD Regular Cab - Longbed (Has solid master cylinder lines)



CT1298SB 2006-07 1500 4WD Regular Cab - Longbed (Has solid master cylinder lines)

CT1253 2007 1500 4WD Regular Cab Longbed

### Fuel - Pump To Carburetor Line

Chevrolet / GMC Truck

Part No.	Year	Model	Description	O.E. Steel	Stainless Steel
CTC1001	1946	1500 and 2500			
CHC1005	1946	Truck	216 CID - 6 Cylinder		
CTC1006	1955	1500	6 Cylinder		
CTC1011	1965	1500	230 CID - 6 Cylinder		
CTC1013	1969	1500	350 CID - 4 Barrel - W/ Air Conditioning		
CTC1014	1972	1500	V8 - W/ Long Fuel Pump		
CTC1002	1972-75	Blazer	350 CID - Quadrajete		
CEC1029	1976-82	1500	350 CID Quadrajete Carburetor		
CTC1010	1982	S10 - S15 - Blazer - Jimmy	2.8 Liter - V6 Fuel Injected		
CTC1012	1982	S10	2.8 Liter - V6 Carbureted		
CTC1008	1984	1500	305 CID - Quadrajete		
CTC1004	1986	1500	350 CID - Quadrajete		

### Fuel - Return Line

Chevrolet / GMC Truck

Part No.	Year	Model	Description	O.E. Steel	Stainless Steel
CTR1063	1970	1500	2WD (2 Pc.)		
CTR1007	1972	1500	2WD (1972)		
CTR1118	1973-81	1500,2500&3500	2WD W/ Single 20 Gallon Tank		
CTR1119	1973-81	1500,2500&3500	2WD W/ Dual 20 Gallon Tank		
CTR1120	1973-81	1500,2500&3500	4WD W/ Single 20 Gallon Tank		
CTR1121	1973-81	1500,2500&3500	4WD W/ Dual 20 Gallon Tanks		
CTR1001	1976-80	1500	2WD Single Tank (2 Pc.)		
CTR1002	1976-80	1500	4WD Dual Tank		
CTR1004	1976-80	1500	4WD Single Tank		
CTR1009	1976-80	Blazer	(2 Pc.)		
CTR1066	1976-80	1500	2WD Dual Tank		
CTR1020	1981-82	1500	4WD Dual Tank		
CTR1033	1981-82	1500	4WD Single Tank		
CTR1018	1981-87	1500	2WD Dual Tank		
CTR1038	1981-87	1500	2WD Single Tank		
CTR1037	1982	S10			
CTR1010	1982-86	1500 Suburban	4WD		
CTR1042	1982-86	2500 Suburban	4WD		
CTR1122	1982-86	1500,2500&3500	2WD W/ Single 20 Gallon Tank (2 Pc.)		
CTR1123	1982-86	1500,2500&3500	2WD W/ Dual 20 Gallon Tanks (3 Pc.)		
CTR1005	1983	S10 - S15 - Blazer - Jimmy	4WD (3 Pc.)		
CTR1003	1983-87	1500	4WD Single Tank		
CTR1011	1983-87	1500	4WD Dual Tank		
CTR1013	1983-87	2500	4WD Dual Tank		
CTR1030	1983-87	2500	4WD Single Tank		
CTR1040	1983-87	Blazer	Full Size (2 Pc.)		

# CHEVROLET

Cont. from previous page

CTR1065	1986	S series S10	2WD Standard Cab Longbed 2.8 Liter V6 With TBI
CTR1029	1987	1500	4WD Dual Tank Only
CTR1044	1987	2500	4WD Single Tank Only - Regular Cab
CTR1097	1987	1500	2WD - Dual Tanks
CTR1052	1987-91	2500 Suburban	4WD (3 Pc.)
CTR1052	1987-91	1500 Suburban	4WD (3 Pc.)
CTR1017	1988	S10	4WD
CTR1034	1988-89	1500	4WD Regular Cab Shortbed
CTR1043	1988-89	1500 and 2500	4WD Regular Cab Longbed
CTR1079	1988-89	3500	2WD Crew Cab 454 CID
CTR1025	1988-91	Blazer	Rear ABS (2 Pc.)
CTR1028	1989	S10 - S15 - Blazer - Jimmy	4WD Extended Cab - 4.3 Liter - V6
CTR1041	1989	S10 - S15 - Blazer - Jimmy	(1 Pc.)
CTR1031	1990	1500 and 2500	4WD Extended Cab Longbed
CTR1061	1990	S10 S15	2WD Regular Cab Shortbed 4 Cylinder Electronic Fuel Injection
CTR1064	1990	1500 and 2500	4WD Regular Cab Longbed
CTR1069	1990	1500 and 2500	4WD Extended Cab Shortbed
CTR1071	1990	1500	4WD Regular Cab Shortbed
CTR1082	1990-91	1500	2WD Regular Cab Shortbed - V6 Motor
CTR1085	1990-95	2500	4WD Regular Cab Longbed - W/ Big Block Motor
CTR1086	1990-95	2500	4WD Extended Cab Shortbed - W/ Big Block Motor
CTR1087	1990-95	2500	4WD Extended Cab Longbed - W/ Big Block Motor
CTR1035	1992	1500	2WD Regular Cab Longbed
CTR1039	1992	S10	4WD Shortbed - 2.8 Liter - Carburetor
CTR1032	1992-93	S10	2WD Longbed - 4.3 Liter - V6 (2 Pc.)
CTR1057	1992-94	Blazer	Full Size V8 2 Door (3 Pc.)
CTR1015	1992-95	1500 and 2500	4WD Extended Cab Shortbed
CTR1016	1992-95	1500 and 2500	4WD Longbed Regular Cab
CTR1045	1992-95	1500	4WD Regular Cab Shortbed
CTR1048	1992-95	1500 and 2500	4WD Extended Cab Longbed
CTR1083	1992-95	1500	2WD Regular Cab Shortbed - Small Block V8
CTR1084	1992-95	2500	4WD Regular Cab Longbed - W/ Big Block Motor
CTR1091	1992-95	1500	2WD Regular Cab Shortbed - V6 Motor
CTR1092	1992-95	1500	2WD Regular Cab Longbed - V6 Motor
CTR1054	1993	S10 Pickup	2WD Regular Cab Shortbed 2.5 Liter 4 Cylinder
CTR1024	1994	3500	Longbed - Regular Cab
CTR1049	1994	S10 Blazer	4WD 4.3 Liter Vortec 4-Door (2 Pc.)
CTR1053	1994	3500	2WD Crew Cab - Diesel - Dual Wheels - Single Tank
CTR1095	1995	1500 Tahoe	4WD
CTR1095	1995	1500 Yukon	4WD
CTR1072	1995-98	1500 and 2500	2WD Regular Cab Longbed
CTR1105	1995-99	1500 Suburban	4WD
CTR1050	1996	Tahoe	4WD 4-Door ABS
CTR1068	1996	Tahoe	2 Door 4WD (3 Pc.)

CTR1026	1996-97	3500	4WD Regular Cab Longbed Single Tank Diesel
CTR1051	1996-97	3500	4WD Regular Cab Longbed Dual Tank Diesel
CTR1074	1996-98	1500 and 2500	4WD Extended Cab Shortbed - Non Big Block
CTR1076	1996-98	1500 and 2500	4WD Regular Cab Longbed - Non Big Block
CTR1077	1996-98	2500	4WD Regular Cab Longbed - 7.4 Liter Big Block Only
CTR1078	1996-98	2500	4WD Extended Cab Shortbed - 7.4 Liter Big Block Only
CTR1088	1996-98	1500	4WD Regular Cab Shortbed - Non Big Block
CTR1089	1996-98	1500 and 2500	4WD Extended Cab Longbed - Non Big Block
CTR1090	1996-98	2500	4WD Extended Cab Longbed - W/ Big Block Only
CTR1077	1996-00	3500	4WD Regular Cab Longbed - 7.4 Liter Big Block Only - Front Section Only
CTR1081	1996-00	3500	4WD Regular Cab Longbed - 7.4 Liter Big Block Only
CTR1075	1999	1500	4WD Regular Cab Shortbed (1999)
CTR1058	2000	1500	4WD Extended Cab Shortbed
CTR1059	2000	Jimmy	4DR 4.3 Liter V6
CTR1067	2000	S10 Blazer	4WD 4.3 V6 Engine Old Bravada
CTR1103	2000	3500	4WD Crew Cab 6.5L Diesel W/ 4L80E Transmission
CTR1096	2000-03	2500 Suburban - Yukon XL	Gas 6.0 and 8.1 - Dual Tanks 4WD (2 Pc.)
CTR1070	2002	1500	4WD HD Crew Cab Shortbed
CTR1093	2002	2500	4WD - Extended Cab - Longbed
CTR1098	2003	2500 Heavy Duty	4WD - Extended Cab - Shortbed - Diesel Motor
CTR1099	2003	2500 Heavy Duty	4WD - Crew Cab - Shortbed
CTR1100	2003	2500 Heavy Duty	4WD - Crew Cab - Shortbed - Diesel Motor
CTR1101	2003	1500	4WD Extended Cab Shortbed
CTR1104	2003	3500	4WD Crew Cab (Cab and Chassis Style) Dual Tanks Diesel
CTR1104	2003	3500	4WD Crew Cab (Cab and Chassis Style) Dual Tanks Diesel
CTR1102	2003-06	1500 Tahoe	With 4WD
CTR1106	2004	1500	4WD Regular Cab Shortbed 5.3 Liter V8
CTR1094	2009	3500	4WD Regular Cab Longbed (137" Wheelbase) (1 Pc.)

**Fuel - Tank To Pump Line**

Part No.	Year	Model	Description	Chevrolet / GMC Truck	
				O.E. Steel	Stainless Steel
CTF1168	1940-45	5000	4WD Military Vehicle		
CTF1018	1942	3500			
CTF1023	1942	1500			
CTF1026	1946	1500			
CTF1001	1947-50	1500			
CTF1002	1954	1500	(2 Pc.)		
CTF1008	1955	1500	2WD Shortbed (2 Pc.)		
CTF1005	1957	1500	Shortbed		
CTF1003	1964-65	1500	2WD Shortbed		
CTF1024	1966	1500	2WD Shortbed		
CTF1004	1967-70	1500	2WD 3/8" Line (2 Pc.)		
CTF1085	1967-70	1500	2WD 5/16" Line (2 Pc.)		
CTF1102	1967-70	2500	4WD 5/16" Line (2 Pc.)		
CTF1007	1971	1500	2WD 5/16" Line (2 Pc.)		
CTF1009	1971	1500	2WD 3/8" Line (2 Pc.)		
CTF1031	1971	1500	4WD 3/8" Line (2 Pc.)		
CTF1042	1971	1500	Longbed - Dual 402 CID		
CTF1006	1971-72	Blazer	4WD (2 Pc.)		
CTF1021	1972	1500	2WD 3/8" Line (2 Pc.)		
CTF1022	1972	1500	2WD Longbed (2 Pc.)		
CTF1060	1972	2500	4WD 3/8" Line (2 Pc.)		
CTF1011	1973-80	1500	2WD Single Tank		
CTF1013	1973-80	1500	2WD Dual Tank		
CTF1184	1973-81	1500	2WD W/ Single 20 Gallon Tank (2 Pc.)		
CTF1186	1973-81	1500	2WD W/ Dual 20 Gallon Tanks (3 Pc.)		
CTF1188	1973-81	1500	4WD W/ Single 16 Gallon Tank (2 Pc.)		
CTF1189	1973-81	1500	4WD W/ Dual 16 Gallon Tanks (2 Pc.)		

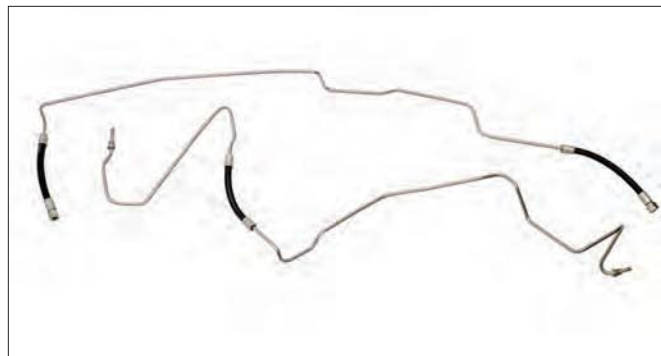

# CHEVROLET



CTF1190	1973-81	1500	4WD W/ Single 20 Gallon Tank (2 Pc.)
CTF1192	1973-81	1500	4WD W/ Dual 20 Gallon Tanks (3 Pc.)
CTF1012	1976-80	2500 and 3500	4WD Single Tank
CTF1015	1976-80	2500 and 3500	4WD Dual Tank - 3/8" (3 Pc.)
CTF1016	1976-80	Blazer & Jimmy	4WD (2 Pc.)
CTF1088	1977	1500	Shortbed 454 CID Big Block 1/2" Line (Front Piece)
CTF1039	1981-82	1500	4WD Single Tank (2 Pc.)
CTF1066	1981-82	1500	4WD Dual Tank (3 Pc.)
CTF1053	1981-87	1500	2WD Single Tank (2 Pc.)
CTF1092	1981-87	Blazer	4WD Full Size (2 Pc.)
CTF1027	1982-86	1500	4WD Suburban 3/8"
CTF1059	1982-86	2500 & 3500	4WD W/ Single 20 Gallon Tank (2 Pc.)
CTF1061	1982-86	2500	Suburban
CTF1185	1982-86	1500	2WD W/ Single 20 Gallon Tank (2 Pc.)
CTF1187	1982-86	1500	2WD W/ Single 20 Gallon Tank (2 Pc.)
CTF1191	1982-86	1500	4WD W/ Single 20 Gallon Tank (2 Pc.)
CTF1193	1982-86	1500	4WD W/ Dual 20 Gallon Tanks (3 Pc.)
CTF1019	1983-86	S10 - S15 - Blazer - Jimmy	4WD (3 Pc.)
CTF1028	1983-86	2500	4WD Dual Tank - 1/2" Front Line
CTF1029	1983-86	1500	4WD Single Tank
CTF1030	1983-86	2500	4WD Single Tank - 1/2" Front Line
CTF1033	1983-86	2500	4WD Diesel Dual Tank (4 pc.)
CTF1037	1983-86	1500	2WD Dual Tank (3 Pc.)
CTF1062	1983-86	1500	4WD Dual Tank (3 Pc.)
CTF1094	1983-86	2500	4WD Diesel Single Tank
CTF1087	1986	S series S10	2WD Standard Cab Longbed 2.8 Liter V6 With TBI
CTF1049	1987	1500 and 2500	4WD - Dual Tanks
CTF1064	1987	1500 and 2500	4WD - Single Tank
CTF1068	1987	3500	4WD - Single Tank
CTF1084	1987	1500 and 2500	2WD - Single Tank
CTF1157	1987	1500	2WD Dual Tanks
CTF1157	1987	2500	2WD Dual Tanks
CTF1072	1987-91	Suburban	4WD Fuel Feed Lines (4 Pc.)
CTF1054	1988-89	1500	4WD Regular Cab Shortbed
CTF1057	1988-89	1500 and 2500	4WD Regular Cab - Longbed
CTF1095	1988-89	1500 and 2500	4WD Extended Cab Longbed
CTF1096	1988-89	1500 and 2500	4WD Extended Cab Shortbed
CTF1109	1988-89	3500	2WD Crew Cab 454 CID
CTF1121	1988-89	1500	2WD - Regular Cab - Shortbed (Non Big Block Motor)
CTF1122	1988-89	1500 and 2500	2WD - Regular Cab - Longbed (Non Big Block Motor)
CTF1045	1988-91	Blazer	Full Size Rear ABS (3 Pc.)
CTF1116	1988-95	2500	4WD Regular Cab - Longbed W/ Big Block Motor

CTF1119	1988-95	2500	4WD Extended Cab - Shortbed W/ Big Block Motor
CTF1120	1988-95	2500	4WD Extended Cab - Longbed W/ Big Block Motor
CTF1032	1989	S10	Regular Cab (2 Pc.)
CTF1048	1989	S10	4WD Extended Cab - 4.3 Liter - V6 (3 Pc)
CTF1051	1990	1500 and 2500	4WD Extended Cab Longbed
CTF1083	1990	S10 S15	2WD Regular Cab Shortbed 4 Cylinder Electronic Fuel Injection
CTF1097	1990	1500 and 2500	4WD Regular Cab Longbed
CTF1098	1990-91	1500	4WD Regular Cab Shortbed
CTF1100	1990-91	1500 and 2500	4WD Extended Cab Shortbed
CTF1113	1990-91	1500	2WD - Regular Cab - Shortbed - V6 Motor
CTF1124	1990-91	1500	2WD - Regular Cab - Longbed - V6 Motor
CTF1125	1990-91	1500	2WD - Regular Cab - Shortbed - V8 Motor (Non Big Block)
CTF1126	1990-91	1500 and 2500	2WD - Regular Cab - Longbed - V8 Motor (Non Big Block)
CTF1128	1990-91	1500	4WD - Regular Cab - Shortbed - V6 Motor
CTF1129	1990-91	1500	4WD - Regular Cab - Longbed - V6 Motor
CTF1130	1990-91	1500	4WD - Extended Cab - Shortbed - V6 Motor
CTF1131	1990-91	1500	4WD - Extended Cab - Longbed - V6 Motor
CTF1036	1992	S10	4WD Shortbed - 2.8 Liter - Carbureted Engine
CTF1052	1992-93	S10 - S15 - Blazer - Jimmy	2WD Longbed - 4.3 Liter - V6 (3 Pc.)
CTF1055	1992-94	1500	2WD Regular Cab - Longbed - 4.3 L (2 Pc.)
CTF1077	1992-94	Blazer	4WD Full Size V8 2 Door (3 Pc.)
CTF1114	1992-94	1500	2WD - Regular Cab - Shortbed - V8 Motor (Non Big Block)
CTF1115	1992-94	1500	4WD - Regular Cab - Shortbed - V6 Motor
CTF1133	1992-94	1500	2WD - Regular Cab - Shortbed - V6 Motor
CTF1134	1992-94	1500 and 2500	2WD - Regular Cab - Longbed - V8 Motor (Non Big Block)
CTF1135	1992-94	1500	4WD - Regular Cab - Longbed - V6 Motor
CTF1136	1992-94	1500	4WD - Extended Cab - Shortbed - V6 Motor
CTF1137	1992-94	1500	4WD - Extended Cab - Longbed - V6 Motor
CTF1034	1992-95	1500 and 2500	4WD Extended Cab Shortbed
CTF1035	1992-95	1500 and 2500	4WD Regular Cab Longbed
CTF1065	1992-95	1500	4WD Regular Cab Shortbed
CTF1101	1992-95	1500 and 2500	4WD Extended Cab Longbed
CTF1074	1993	S10 Pickup	2WD Regular Cab Shortbed 2.5 Liter 4 Cylinder
CTF1044	1994	3500	Regular Cab - Longbed (2 Pc.)
CTF1069	1994	S10 - Blazer	4WD Vortec 4.3 Liter 4 Door (3 Pc.)
CTF1073	1994	3500	2WD Crew Cab - Diesel - Dual Wheels - Single Tank
CTF1141	1995	1500	2WD - Regular Cab - Shortbed - (Non Big Block Motor)

# CHEVROLET

Cont. from previous page

CTF1142	1995	1500 and 2500	2WD - Regular Cab - Longbed - Non Big Block Motor
CTF1143	1995	1500	4WD - Regular Cab - Shortbed - V8 Motor (Non Big Block)
CTF1144	1995	1500 and 2500	4WD - Regular Cab - Longbed - V8 Motor (Non Big Block)
CTF1145	1995	1500 and 2500	4WD - Extended Cab - Shortbed - V8 Motor (Non Big Block)
CTF1146	1995	1500 and 2500	4WD - Extended Cab - Longbed - V8 Motor (Non Big Block)
CTF1104	1995-97	S10 Blazer	4WD 2 Door
CTF1103	1995-98	1500	2WD Regular Cab Longbed
CTF1165	1995-99	1500 Suburban	4WD (3 Pc.)
CTF1165	1995-99	1500 Suburban	4WD (3 Pc.) Fuel - F.I. Feed Line
CTF1070	1996	Tahoe	4WD 4-Door
CTF1090	1996	Tahoe	2 Door 4WD (3 Pc.)
CTF1082	1996-98	2500	4WD Regular Cab Longbed - 7.4 Liter Big Block Only
CTF1105	1996-98	1500 and 2500	4WD Extended Cab Shortbed - Non Big Block
CTF1108	1996-98	2500	4WD Extended Cab Shortbed - 7.4 Liter Big Block Only
CTF1117	1996-98	1500	2WD - Regular Cab - Shortbed (Non Big Block Motor)
CTF1118	1996-98	1500	4WD - Regular Cab - Shortbed (Non Big Block Motor)
CTF1150	1996-98	1500 and 2500	4WD - Extended Cab - Longbed - Non Big Block Motor
CTF1151	1996-98	2500	4WD Extended Cab - Longbed W/ Big Block Motor
CTF1107	1996-99	2500	4WD Regular Cab Longbed - Non Big Block
CTF1082	1996-00	3500	4WD Regular Cab Longbed - 7.4 Liter Big Block Only - Front Section Only
CTF1111	1996-00	3500	4WD Regular Cab Longbed - Non Big Block Motor
CTF1112	1996-00	3500	4WD Regular Cab Longbed - 7.4 Liter Big Block Only
CTF1107	1998-99	1500	4WD Regular Cab Longbed - Non Big Block
CTF1106	1999	1500	4WD Regular Cab Shortbed
CTF1079	1999-03	1500	Extended Cab - Shortbed and Longbed
CTF1080	2000	Jimmy	4WD 4.3 Liter V6
CTF1089	2000	S10 Blazer	4WD 4.3 V6 Engine
CTF1163	2000	3500	4WD Crew Cab 6.5L Diesel W/ 4L80E Transmission
CTF1110	2001	Tahoe	Tank to Filter Line
CTF1155	2001	2500 Suburban	4WD 8.1 Liter - Dual Tanks (2 Pc.)
CTF1093	2001-03	1500 Heavy Duty	Crew Cab Shortbed
CTF1152	2001-04	2500 Heavy Duty	Extended Cab - Shortbed and Longbed
CTF1156	2002	3500 Heavy Duty	8.1 Liter Crew Cab Longbed
CTF1169	2002	2500 Suburban	4WD 8.1 Liter - Dual Tanks (2 Pc.)
CTF1158	2003	2500 Heavy Duty	4WD - Extended Cab - Shortbed - Diesel Motor
CTF1159	2003	2500 Heavy Duty	4WD - Crew Cab - Shortbed
CTF1160	2003	1500	4WD Extended Cab Shortbed
CTF1161	2003	2500 Heavy Duty	4WD - Crew Cab - Shortbed - Diesel
CTF1164	2003	3500	4WD Crew Cab - Cab and Chassis Style Diesel - Dual Tanks
CTF1170	2003	2500 Suburban	4WD 8.1 Liter - Dual Tanks (2 Pc.)
CTF1162	2003-06	1500 Tahoe	With AWD
CTF1166	2004	1500	4WD - Extended Cab Shortbed
CTF1167	2004	1500	4WD - Regular Cab Shortbed 5.3 Liter V8
CTF1153	2009	3500	4WD Regular Cab Longbed (137" Wheelbase) (2 Pc.)

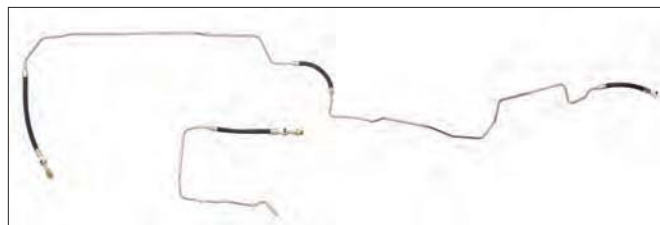

Fuel - Vapor Line				Chevrolet / GMC Truck	
Part No.	Year	Model	Description	O.E. Steel	Stainless Steel
CTV1001	1971-72	1500	Shortbed (3 Pc.)		
CTV1013	1971-72	Blazer	(8 Pc.)		
CTV1085	1973-81	1500	4WD W/ Dual 16 Gallon Tanks (3 Pc.)		
CTV1086	1973-81	1500	4WD W/ Single 20 Gallon Tank (3 Pc.)		
CTV1087	1973-81	1500	4WD W/ Dual 20 Gallon Tank (3 Pc.)		
CTV1003	1976-80	1500	4WD (2 Pc.)		
CTV1011	1976-80	Blazer	4WD (3 Pc.)		
CTV1009	1981-87	1500	4WD Single Tank		
CTV1010	1981-87	1500 Suburban	4WD		
CTV1014	1981-87	1500	2WD Dual Tank (3 Pc.)		
CTV1015	1981-87	1500	4WD Dual Tank		
CTV1019	1981-87	1500	2WD Single Tank (3 Pc.)		
CTV1020	1981-87	2500	4WD Dual Tank (3 Pc.)		
CTV1021	1981-87	2500	2WD Single Tank (3 Pc.)		
CTV1038	1981-87	Blazer	4WD		
CTV1041	1981-87	2500	4WD Single Tank		
CTV1042	1981-87	2500	2WD Dual Tank		
CTV1005	1983	S10 - S15 - Blazer - Jimmy	(2 Pc.)		
CTV1059	1986	S series S10	(1986) - 2WD Standard Cab Longbed 2.8 Liter V6 With TBI		
CTV1046	1987	1500	4WD Single Tank - 305 TBI		
CTV1057	1987	1500	2WD Longbed Fuel Injected		
CTV1023	1987-91	Blazer	Full Size - Rear ABS (2 Pc.)		
CTV1030	1988	1500 and 2500	4WD Regular Cab Shortbed		
CTV1036	1988	S10	4WD		
CTV1047	1988	1500 and 2500	4WD Extended Cab Shortbed (2 pc.)		
CTV1049	1988	1500 and 2500	4WD Regular Cab Longbed		
CTV1070	1988-89	3500	2WD Crew Cab 454 CID		
CTV1027	1989	S10 - S15 - Blazer - Jimmy	4WD Extended Cab 4.3 Liter V6		
CTV1028	1989	S10 - S15 - Blazer - Jimmy	4WD Extended Cab 4.3 Liter V6		
CTV1040	1989	S10 - S15 - Blazer - Jimmy	(1 Pc.)		
CTV1016	1989-94	1500 and 2500	4WD Extended Cab Shortbed		
CTV1022	1989-94	3500	2WD Regular Cab Longbed - No Front Line		
CTV1024	1989-94	1500 and 2500	4WD Regular Cab Longbed		
CTV1033	1989-94	1500 and 2500	4WD Regular Cab Shortbed		
CTV1034	1989-94	1500 and 2500	2WD Regular Cab Longbed		
CTV1037	1989-94	1500 and 2500	2WD Regular Cab Shortbed (2 Pc.)		
CTV1056	1990	S10 S15	2WD Regular Cab Shortbed 4 Cylinder Electronic Fuel Injection		
CTV1068	1990-91	Suburban	1500 4WD		
CTV1031	1992	S10	2WD Longbed - 4.3 Liter V6		
CTV1035	1992	S10	4WD Shortbed - 2.8 Liter Carburetor		
CTV1052	1992-94	Blazer	4WD Full Size V8 2 Door (3 Pc.)		
CTV1039	1994	S10 - Blazer	4WD 4-Door 4.3 Liter Vortec		
CTV1017	1995	1500 and 2500	4WD Regular Cab Longbed		
CTV1058	1995	1500 and 2500	4WD Extended Cab Shortbed		
CTV1062	1995	1500 and 2500	4WD Regular Cab Shortbed		
CTV1063	1995	1500 and 2500	4WD Extended Cab Longbed		
CTV1067	1995-97	S10 Blazer	4WD 2 Door (3 Pc.)		
CTV1051	1996	Tahoe	4WD 4 Door ABS (2 Pc.)		
CTV1050	1996-98	1500 and 2500	4WD Extended Cab Shortbed		
CTV1055	1996-98	1500 and 2500	4WD Extended Cab Longbed		
CTV1064	1996-98	1500 and 2500	4WD Regular Cab Shortbed		
CTV1065	1996-98	1500 and 2500	4WD Regular Cab Longbed		
CTV1069	1999	1500	4WD Regular Cab Shortbed		
CTV1053	2000	Truck	4WD Extended Cab Shortbed		
CTV1054	2000	Jimmy	4WD 4.3 Liter V6 (2 Pc.)		
CTV1060	2000	S10	4WD 4.3 V6 Engine		
CTV1073	2001	2500	4WD 8.1 Liter - Dual Tanks (2 Pc.) Suburban		
CTV1061	2002	1500	4WD HD Crew Cab Shortbed		

## CHEVROLET

CTV1071	2002	2500 Heavy Duty	4WD - Extended Cab - Longbed
CTV1074	2003	2500 Heavy Duty	4WD Crew Cab Shortbed
CTV1075	2003	1500	4WD Extended Cab Shortbed
CTV1076	2003-06	Tahoe	With AWD
CTV1072	2009	3500	4WD Regular Cab Longbed (137" Wheelbase) (1 Pc.)

Transmission Lines (Sold In Pairs)				Chevrolet / GMC Truck	
Part No.	Year	Model	Description	O.E. Steel	Stainless Steel
CTT1012	1966	1500	2WD Powerglide		
CTT1001	1970	1500 - Blazer	2WD T-350		
CTT1002	1971-75	1500 - Blazer	2WD T-350 and T-400		
CTT1003	1971-75	1500 - Blazer	4WD T-350 and T-400		
CTT1004	1976-79	S10 - Blazer - Jimmy	2WD T-350		
CTT1005	1976-79	1500 - Blazer	4WD T-350		
CTT1029	1982	1500	4WD Diesel - 700-R4		
CTT1006	1982-87	1500	4WD 700-R4		
CTT1021	1982-87	1500	2WD T-400 and 700R4		
CTT1032	1984	S10	2WD		
CTT1008	1985	S10 - S15 - Jimmy	4WD 2.8 Liter - V6		
CTT1013	1988-92	1500	700-R4		
CTT1023	1989	S10	4WD 4.3 Liter - V6		
CTT1044	1991	1500 Cyclone	700 R4 Transmission		
CTT1041	1991-95	3500	4WD 4L80E Transmission (5/16")		
CTT1022	1993-95	1500	700-R4 - Standard Cooling		
CTT1028	1994	S15 - Blazer - Jimmy	4WD 4.3 Liter		
CTT1031	1994	3500	4L80E Transmission (5/16")		
CTT1011	1995	S10 - Blazer	4.3 Liter		
CTT1019	1995	2500	4WD 4L80 Transmission - W/ Auxiliary Cooler (5/16") (4 Pc.)		
CTT1025	1995	Tahoe	1500		
CTT1020	1996	1500	4L60 Transmission - V8 (3/8")		
CTT1024	1996	1500	4L60 Transmission - V6 (3/8")		
CTT1033	1996	1500	4WD 4L60 Transmission - V6 (3/8")		
CTT1040	1997	1500	4WD 4L60E Transmission W/ Auxiliary Cooler (3/8")		
CTT1027	1997-99	2500	4WD 4L80E Transmission W/ Auxiliary Cooler (3/8") (3 Pc.)		
CTT1035	1997-99	3500	4L80 Transmission W/ Auxiliary Cooler (3/8")		
CTT1043	1998	1500	4WD 4L60E Transmission 5.0 Liter		
CTT1043	1998	1500	4WD 4L60E Transmission 5.7 Liter		
CTT1042	1999	2500 Van	4L60E Transmission		
CTT1030	2001	1500	4WD 4L60E Transmission (3/8")		
CTT1036	2001	1500	4WD 4L60 Transmission W/ Auxiliary Cooler (3/8")		
CTT1038	2002	1500	Heavy Duty 4WD 4L80 Transmission W/ Auxiliary Cooler (3/8")		
HRT1001	2003-07	Hummer H2	4L65E Transmission		

Transmission Modulator Line				Chevrolet / GMC Truck	
Part No.	Year	Model	Description	O.E. Steel	Stainless Steel
CAM1003	1969-72	Blazer - 1500	T-350		
CAM1002	1971-75	Pick Up	T-350 Transmission		
CTM1002	1976-80	1500 & Blazer	T-350		
CTM1004	1981-86	1500	T-400 Vacuum Modulation Line		
CTM1005	1988-90	1500	4.3L - T-400		
CTM1006	1988-90	1500	5.7 Liter TH400 Transmission		
CTM1007	1988-90	1500	7.4 Liter Motor		

Tubing Line Clamps				Chevrolet / GMC Truck	
Part No.	Year	Model	Description	O.E. Steel	Stainless Steel
CLP4020	1968-81	GM Double Tube Clamp With Tab (1/2" & 3/8") Silver	Double Tube Clamp With Tab (1/2" & 3/8") Silver		
CLP4030	1968-81	GM Double Tube Clamp With Tab (5/16" & 5/16") Black	Double Tube Clamp With Tab (5/16" & 5/16") Black		

Hydraulic Clutch Line				Chevrolet / GMC Truck	
Part No.	Year	Model	Description	O.E. Steel	Stainless Steel
CTH1001	1963	1500 Suburban	305 CID and V6 Motors		



Miscellaneous & Other Lines				Chevrolet / GMC Truck	
Part No.	Year	Model	Description	O.E. Steel	Stainless Steel
CH01004	1946	1500	Distributor Vacuum Line		
CH01010	1965	1500	6 Cylinder - 230 CID		
CTO1006	1968-72	1500 Blazer	Power Steering Return Line		
CTO1009	1968-72	1500	2WD 396 and 402 CID Power Steering Line		
CTO1009	1968-72	2500	2WD 396 and 402 CID Power Steering Line		
CTO1009	1968-72	3500	2WD 396 and 402 CID Power Steering Line		
CA01001	1971-74	1500 Blazer	350 CID - Brake Booster Vacuum Line		
CTO1010	1972	1500	2WD 350 CID Power Steering Pressure Line		
CTO1010	1972	2500	2WD 350 CID Power Steering Pressure Line		
IBO1006	1976-79	1500	Brake Booster - 350 CID Vacuum Line		
CTO1014	1977	1500	Shortbed 454 CID Big Block Power Steering Hoses		
CTO1017	1991	1500	Syclone Power Steering Pressure Line		
CTO1007	1994	2500	Power Steering Feed Line - 4WD K-2500 Regular Cab Longbed		
CTO1008	1994	2500	Power Steering Return Line - 4WD K-2500 Regular Cab Longbed		
CTO1013	1995-98	2500 Tahoe	4WD Engine Oil Cooler Lines		
CTO1013	1996	1500 Tahoe	4WD Engine Oil Cooler Lines		
CTO1015	1996-98	2500	4WD With Hydro Boost System - Power Steering Line Set		

### GMC MOTOR HOME

Complete Brake Line Kit				GMC Motor Home	
Part No.	Year	Description		O.E. Steel	Stainless Steel
GMC1001	1973-78	Motor Coach	Series 230 - 23'		
GMC1002	1973-78	Motor Coach	Series 260 - 26'		

Fuel - Pump To Carburetor Line				GMC Motor Home	
Part No.	Year	Description		O.E. Steel	Stainless Steel
GMC1003	1974-76	Motor Coach	455 CID Olds - Carburetor Lines		

Fuel - Tank To Pump Line				GMC Motor Home	
Part No.	Year	Description		O.E. Steel	Stainless Steel
GMC1004	1974-76	Motor Coach	Fuel - Tank Line 26' - 1/2"		

Fuel - Miscellaneous				GMC Motor Home	
Part No.	Year	Description		O.E. Steel	Stainless Steel
GMC1005	1974-76	Motor Coach	26' (3 Pc.) Tank to Separator - 3/8" Tank to Vent - 3/8" Tank to Separator - 5/16"		

Transmission Lines (Sold In Pairs)				GMC Motor Home	
Part No.	Year	Description		O.E. Steel	Stainless Steel
GMC1007	1973-78	Motor Coach	425		

Transmission Modulator Line				GMC Motor Home	
Part No.	Year	Description		O.E. Steel	Stainless Steel
GMC1006	1974-76	Motor Coach	425		

# CHRYSLER

## CHRYSLER EARLY & MISC.

### Complete Brake Line Kit

### Chrysler Early & Misc.

Part No.	Year	Description	O.E. Steel	Stainless Steel
CY1016	1936	Sedan Air Flow C-9		
CY1001	1946-48	Royal, Windsor and Town & Country 6 cyl.		
CY1008	1946-48	New Yorker		
CY1008	1946-48	Saratoga		
CY1008	1946-48	Town & Country 8 Cylinder		
CY1018	1949-50	Royal		
CY1018	1949-52	Windsor		
CY1014	1955-56	New Yorker		
CY1002	1955-56	Windsor		

CY1007	1957	300
CY1019	1957	Windsor
CY1007	1957-59	New Yorker
CY1007	1958	300E
CY1003	1960	Imperial LeBaron
CY1009	1967-68	New Yorker Standard Drum
CY1009	1967-68	Newport Standard Drum
CY1005	1969	300 Newport
CY1006	1969-71	300 Hurst Power Disc
CY1021	1969-71	New Yorker
CY1021	1969-71	Newport
CY1015	1979	Cordoba
CY1022	1987-89	Laser

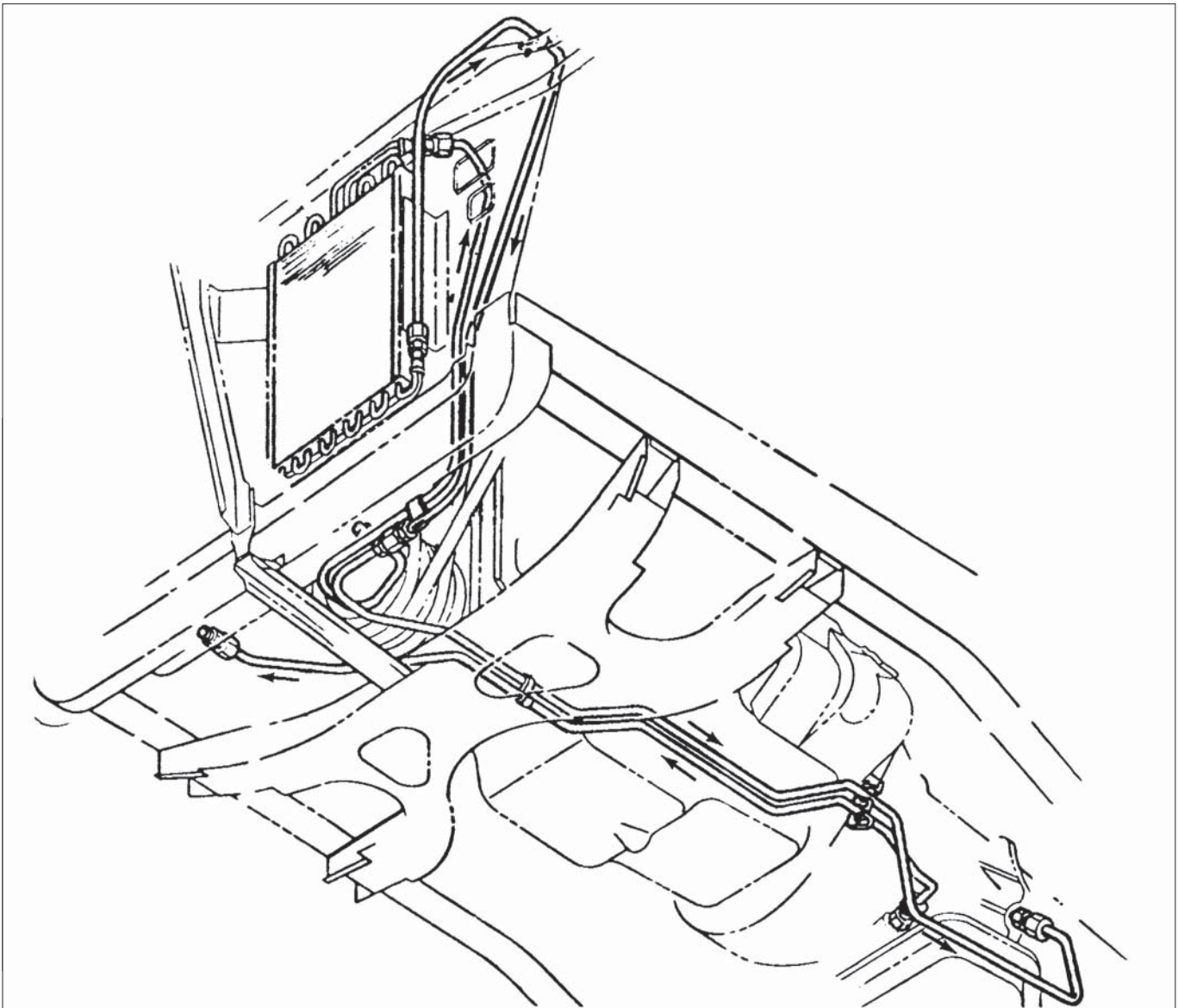

# CHRYSLER

**Caliper Inlet Lines & Transfer Tubes (Sold in Pairs) Chrysler Early & Misc.**

Part No.	Year	Description	O.E. Steel	Stainless Steel
MUD1001	1965-72	A-Body 4 Piston - Kelsey Hayes - Disc Brake Transfer Tube		
CYD1005	1968-72	A-Body Drum - Inlet Lines		
CYD1004	1972-73	A-Body Disc - Inlet Lines		
MBD1001	1990-94	Eagle Talon Tsi AWD - Non ABS		

**Fuel - Pump To Carburetor Line Chrysler Early & Misc.**

Part No.	Year	Description	O.E. Steel	Stainless Steel
CYC1021	1948	Windsor 5/16"		
CYC1001	1956	All Models		
CYC1019	1957	300 5/16"		
CYC1002	1960	300 440 CID - 4 Barrel		
CYC1022	1960	New Yorker		
CYC1018	1961	Imperial 413 CID - 4 Barrel		
CYC1027	1962	300H		
CYC1011	1965-66	A-Body 273 CID V8 - 4 Barrel AFB Carter (2 Pc.)		
CYC1020	1965-66	B-Body 6 Cylinder		
CYC1006	1966-67	All Models 361/383/440 CID - Carter AFB (2 Pc.)		
CYC1007	1966-67	All Models 383 CID - Carter AVS (1 Pc.)		
CYC1016	1966-67	All Models Hemi - Set (4 Pc.)		
CYC1004	1967-72	All Models 340 CID - Carter Thermo Quad - Set (2 Pc.)		
CYC1005	1967-72	All Models 340 CID - Carter AVS (2 Pc.)		
CYC1023	1968	A-Body 6 Cylinder (2 Pc.)		
CYC1003	1968-70	All Models 318 CID - 2 Barrel (2 Pc.)		
CYC1008	1968-71	All Models 440 CID - Carter AVS (2 Pc.)		
CYC1017	1968-71	All Models Hemi - Set (4 Pc.)		
CYC1013	1969-71	All Models 340/440 CID - Upper Set (4 Pc.)		
CYC1014	1969-71	All Models 340 CID - Lower Set (2 Pc.)		
CYC1015	1969-71	All Models 440 CID - Lower Set		
CYC1024	1969-71	All Models 340 CID - Set (6 Pc.)		
CYC1025	1969-71	All Models 440 CID - Set (6 Pc.)		
CYC1009	1970-72	All Models 400/440 CID - Carter Thermo Quad (2 Pc.)		
CYC1010	1970-72	All Models 383/440 CID - 4 Barrel Holley (1 Pc.)		
CYC1026	1973	All Models 340 CID 4 Barrel - Thermoquad		
CYC1028	1975	Cordoba 360 CID 2 Barrel Holley Carburetor		

**Fuel - Tank To Pump Line Chrysler Early & Misc.**

Part No.	Year	Description	O.E. Steel	Stainless Steel
CYF1001	1947	All Models (2 Pc.)		
CYF1007	1948	Windsor 5/16" (2 Pc.)		
CYF1008	1956	New Yorker		
CYF1006	1957	300 5/16" (1 Pc.)		
CYF1009	1958	300 D		
CYF1003	1960	300 H & 300 F		
CYF1012	1961	300G Convertible		
CYF1011	1962	300 H		
CYF1005	1969-70	Newport & 300		
CYF1010	1979	Cordoba 300		
CYR1001	1979	Cordoba - Return Line (2 Pc.)		

**Fuel - Vapor Line Chrysler Early & Misc.**

Part No.	Year	Description	O.E. Steel	Stainless Steel
CVV1001	1979	Cordoba		



**Fuel - Vent Line Chrysler Early & Misc.**

Part No.	Year	Description	O.E. Steel	Stainless Steel
CY01002	1961	300G Tank Vent Line		

**Transmission Lines (Sold In Pairs) Chrysler Early & Misc.**

Part No.	Year	Description	O.E. Steel	Stainless Steel
CYT1014	1955	New Yorker		
CYT1001	1956-57	300D		
CYT1004	1957	300		
CYT1011	1958	300D		
CYT1002	1960	Imperial		
CYT1007	1970	Big Block - 727 Torque Flite		
CYT1013	1979	Cordoba 300		

**Choke Tube Chrysler Early & Misc.**

Part No.	Year	Description	O.E. Steel	Stainless Steel
CYK1001	1966-70	All Models 426 CID - Hemi (3 Pc.)		
CYK1001	1966-70	All Models		

# DODGE

## DODGE EARLY & MISC.

### Complete Brake Line Kit

			Dodge Early & Misc.	
Part No.	Year	Description	O.E. Steel	Stainless Steel
DD1052	1946-58	Power Wagon		
DD1001	1953-54	D-48 Coronet		
DD1001	1954	Royal		
PY1013	1962-64	Polara w /8-3/4" Axle		
PY1013	1962-64	Savoy w /8-3/4" Axle		
PY1013	1962-65	330 w /8-3/4" Axle		
AB1036	1971	Demon Power Drum - 108" Wheelbase 8-3/4" Axle		
AB1065	1971	Demon Standard Brake - 108" Wheelbase 8-3/4" Axle		
AB1098	1971	Demon Standard Brake - 108" Wheelbase 7-1/4" Axle		
AB1100	1971	Demon Power Brake - 108" Wheelbase 7-1/4" Axle		
AB1029	1972	Demon Standard Brake - 108" Wheelbase 8-3/4" Axle		
AB1043	1972	Demon Power Drum - 108" Wheelbase 8-3/4" Axle		
AB1075	1972	Demon Power Drum - 108" Wheelbase 7-1/4" Axle		
AB1077	1972	Demon Standard Disc - 108" Wheelbase 7-1/4" Axle		

### Caliper Inlet Lines & Transfer Tubes (Sold in Pairs)

			Dodge Early & Misc.	
Part No.	Year	Description	O.E. Steel	Stainless Steel
CYD1006	1957-59	All Models Front Dual Wheel Cylinder - Transfer Tubes		
DD01001	1968	Polara Convertible - Inlet Lines		
CYD1003	1968-69	All Models Disc Brakes - Bendix Calipers - Inlet Lines (4 Piston)		

### Wheel Cylinder Lines (Sold in Pairs)

			Dodge Early & Misc.	
Part No.	Year	Description	O.E. Steel	Stainless Steel
CYD1002	1965-69	All Models Disc Brakes - Kelsey Hayes Calipers - Inlet Lines (4 Piston)		
CYD1005	1968	All Models Drums		
CYD1004	1972-74	All Models Drums		

### Fuel - Tank To Pump Line

			Dodge Early & Misc.	
Part No.	Year	Description	O.E. Steel	Stainless Steel
DDF1015	1948	Power Wagon (2 Pc.)		
DDF1001	1954	D-48 Convertible		
DDF1011	1968	Polara Convertible (2 Pc.)		
ABF1005	1971-72	Demon 108" WB 5/16"		
ABF1006	1971-72	Demon 108" WB 3/8"		
ABF1013	1971-72	Demon 108" WB 5/16" - Dual Exhaust		
DDF1020	1996	Neon 2 Door Sport Coupe		

### Fuel - Vapor Line

			Dodge Early & Misc.	
Part No.	Year	Description	O.E. Steel	Stainless Steel
ABV1001	1971-72	Demon 108" WB		
DDV1014	1996	Neon 2 Door Sport Coupe		

### Transmission Lines (Sold In Pairs)

			Dodge Early & Misc.	
Part No.	Year	Description	O.E. Steel	Stainless Steel
BBT1007	1964	Fury V8 A727 Transmission		
BBT1007	1964	Savoy A727 Transmission		
BBT1012	1966-70	Coronet Small Block V8 w/ A904 Transmission		
ABT1004	1971-72	Demon V8 A727 Transmission		
CYT1009	1979	Magnum 727A		

### Miscellaneous & Other Lines

			Dodge Early & Misc.	
Part No.	Year	Description	O.E. Steel	Stainless Steel
CY01004	2000	Caravan V6 - Power Steering Rack Lines		
DD01004	2000	Neon 2.0 Liter - Power Steering Rack Lines		
DD01003	2003	Caravan V6 - Power Steering Rack Lines		

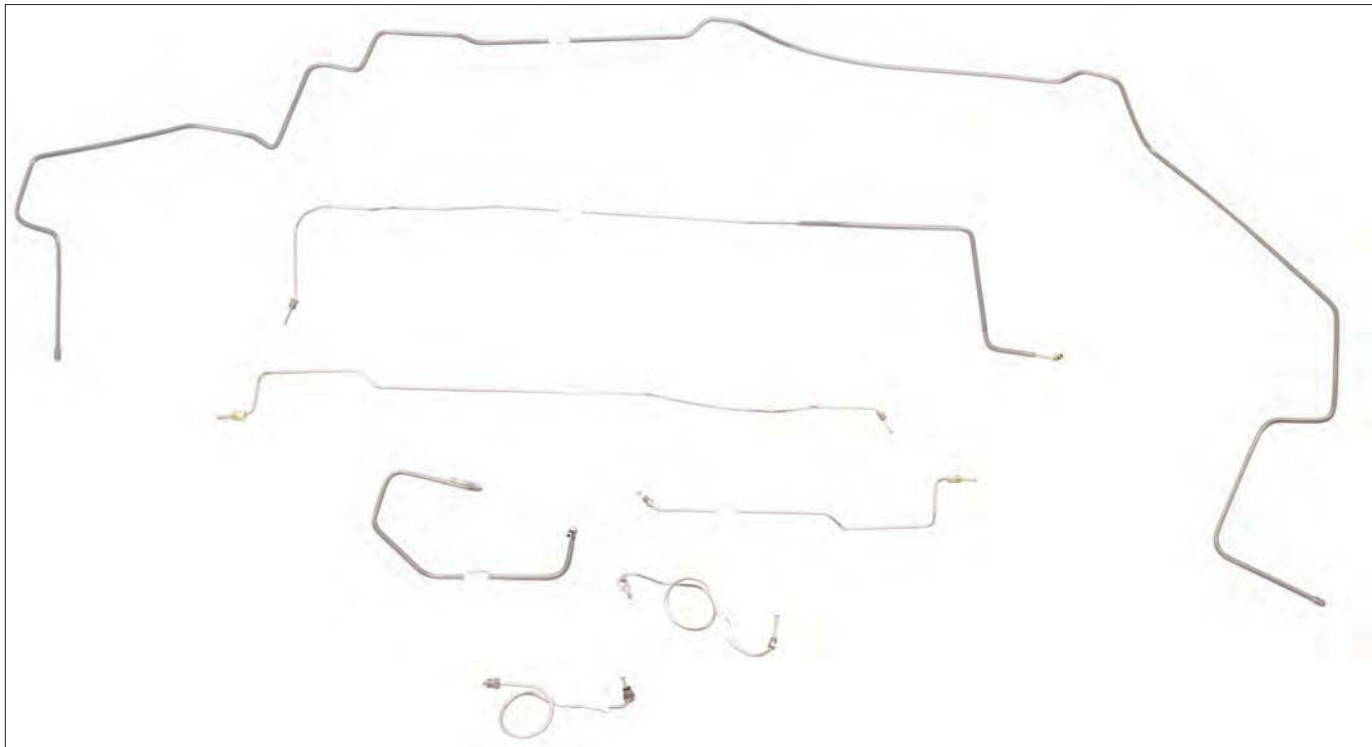

## DODGE

### CHALLENGER

#### Complete Brake Line Kit

Part No.	Year	Description	Challenger	
			O.E. Steel	Stainless Steel
EB1004	1970-71	Standard Drum - RF Line: Routes Under Frame - 8-3/4" and Dana Axle		
EB1008	1970-71	Power Drum - RF Line: Routes Under Frame - 8-3/4" and Dana Axle		
EB1012	1970-71	Standard Disc - RF Line: Routes Under Frame - 8-3/4" and Dana Axle		
EB1016	1970-71	Power Disc - RF Line: Routes Under Frame - 8-3/4" and Dana Axle		
EB1020	1970-71	Hemi & 6 Pack Big Block - Power Disc - RF Line: Routes Under Frame (5 Pc.) - 8-3/4" and Dana Axle		
EB1040	1970-71	Standard Drum - RF Line: Routes Over Frame - 8-3/4" and Dana Axle		
EB1044	1970-71	Power Drum - RF Line: Routes Over Frame - 8-3/4" and Dana Axle		
EB1048	1970-71	Standard Disc - RF Line: Routes Over Frame - 8-3/4" and Dana Axle		
EB1052	1970-71	Power Disc - RF Line: Routes Over Frame - 8-3/4" and Dana Axle		
EB1056	1970-71	Hemi & 6 Pack Big Block - Power Disc - RF Line: Routes Over Frame (5 Pc.) - 8-3/4" and Dana Axle		
EB1080	1970-71	Standard Disc - Right Front Routes Over Frame - 8-3/4" and Dana - W/ Metering Valve (2 Pc. Front to Rear)		
EB1081	1970-71	Power Disc - Right Front Routes Under Frame - 8-3/4" and Dana - W/ Metering Valve (2 Pc. Front to Rear)		
EB1024	1972-74	Standard Drum - RF Line: Routes Under Frame - 8-3/4" and Dana Axle		
EB1028	1972-74	Power Drum - RF Line: Routes Under Frame - 8-3/4" and Dana Axle		
EB1032	1972-74	Standard Disc - RF Line: Routes Under Frame - 8-3/4" and Dana Axle		
EB1036	1972-74	Power Disc - RF Line: Routes Under Frame - 8-3/4" and Dana Axle		
EB1060	1972-74	Standard Drum - RF Line: Routes Over Frame - 8-3/4" and Dana Axle		
EB1064	1972-74	Power Drum - RF Line: Routes Over Frame - 8-3/4" and Dana Axle		
EB1068	1972-74	Standard Disc - RF Line: Routes Over Frame - 8-3/4" and Dana Axle		
EB1072	1972-74	Power Disc - RF Line: Routes Over Frame - 8-3/4" and Dana Axle		

#### Fuel - Tank To Pump Line

Part No.	Year	Description	Challenger	
			O.E. Steel	Stainless Steel
CLF1001	1970-74	Small Block - 5/16"		
CLF1002	1970-74	Big Block - 3/8"		
DDF1024	2009	Tank to Pump Line		

#### Fuel - Return Line

Part No.	Year	Description	Challenger	
			O.E. Steel	Stainless Steel
CLR1001	1970-74	1/4"		

#### Fuel - Vapor Line

Part No.	Year	Description	Challenger	
			O.E. Steel	Stainless Steel
CLV1001	1970-74	5/16" (2 Pc.)		

#### Transmission Lines (Sold In Pairs)

Part No.	Year	Description	Challenger	
			O.E. Steel	Stainless Steel
BBT1010	1970	Small Block - A727 Transmission		
BBT1005	1970-74	Small Block - 904 Transmission		
BBT1006	1970-74	Big Block - 727 Transmission		
BBT1013	1972-74	Hemi - 727 with Aux Cooler (4 Pc.)		

### CHARGER

#### Complete Brake Line Kit

Part No.	Year	Description	Charger	
			O.E. Steel	Stainless Steel
BB1003	1966	Standard Brake - Right Line Straight at Center - Drum - 7-1/4" Axle		
BB1004	1966	Standard Brake - Right Front Line Straight at Center - Drum - 8-3/4" Axle		
BB1005	1966	Standard Brake - Right Front Line Straight at Center - Drum - Dana Axle		
BB1009	1966	Standard Brake - Right Front Line 4" Rise at Center - Drum - 7-1/4" Axle		
BB1010	1966	Standard Brake - Right Front Line 4" Rise at Center - Drum - 8-3/4" Axle		
BB1011	1966	Standard Brake - Right Front Line 4" Rise at Center - Drum - Dana Axle		
BB1015	1966	Power Brake - Right Front Line Straight at Center - Drum - 7-1/4" Axle		

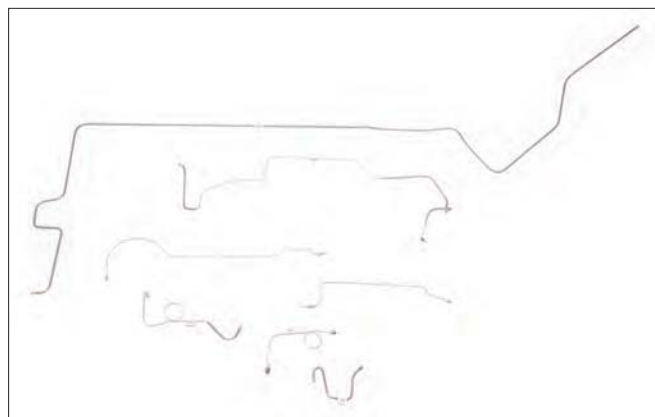

BB1016	1966	Power Brake & Hemi - Right Front Line Straight at Center - Drum - 8-3/4" Axle
BB1017	1966	Power Brake & Hemi - Right Front Line Straight at Center - Drum - Dana Axle
BB1020	1966	Power Brake - Right Front Line 4" Rise at Center - Drum - 7-1/4" Axle
BB1021	1966	Power Brake & Hemi - Right Front Line 4" Rise at Center - Drum - 8-3/4" Axle
BB1022	1966	Power Brake & Hemi - Right Front Line 4" Rise at Center - Drum - Dana Axle
BB1026	1967	Standard Drum Brake - Right Front Line 4" Rise at Center - 7-1/4" Axle
BB1027	1967	Standard Drum Brake - Right Front Line Straight at Center - 8-3/4" Axle
BB1028	1967	Standard Drum Brake - Right Front Line Straight at Center - Dana Axle
BB1029	1967	Standard Disc Brake - Right Front Line Straight at Center - 7-1/4" Axle
BB1030	1967	Standard Disc Brake - Right Front Line Straight at Center - 8-3/4" Axle
BB1031	1967	Standard Disc Brake - Right Front Line Straight at Center - Dana Axle
BB1032	1967	Standard Drum Brake - Right Front Line 4" Rise at Center - 7-1/4" Axle
BB1033	1967	Standard Drum Brake - Right Front Line 4" Rise at Center - 8-3/4" Axle
BB1034	1967	Standard Drum Brake - Right Front Line 4" Rise at Center - Dana Axle
BB1035	1967	Standard Disc Brake - Right Front Line 4" Rise at Center - 7-1/4" Axle
BB1036	1967	Standard Disc Brake - Right Front Line 4" Rise at Center - 8-3/4" Axle
BB1037	1967	Standard Disc Brake - Right Front Line 4" Rise at Center - Dana Axle
BB1038	1967	Power Drum Brake - Right Front Line Straight at Center - 7-1/4" Axle
BB1039	1967	Power Drum Brake - Right Front Line Straight at Center - 8-3/4" Axle
BB1040	1967	Power Drum Brake - Right Front Line Straight at Center - Dana Axle
BB1041	1967	Power Disc Brake - Right Front Line Straight at Center - 7-1/4" Axle
BB1042	1967	Power Disc Brake - Right Front Line Straight at Center - 8-3/4" Axle
BB1043	1967	Power Disc Brake - Right Front Line Straight at Center - Dana Axle
BB1044	1967	Power Drum Brake - Right Front Line 4" Rise at Center - 7-1/4" Axle
BB1045	1967	Power Drum Brake - Right Front Line 4" Rise at Center - 8-3/4" Axle
BB1046	1967	Power Drum Brake - Right Front Line 4" Rise at Center - Dana Axle
BB1047	1967	Power Disc Brake - Right Front Line 4" Rise at Center - 7-1/4" Axle
BB1048	1967	Power Disc Brake - Right Front Line 4" Rise at Center - 8-3/4" Axle
BB1049	1967	Power Disc Brake - Right Front Line 4" Rise at Center - Dana Axle
BB1142	1967	Power Disc - Right Front straight at Center - 8-3/4" Axle
BB1145	1967	Power Disc - Right Front Line 4" Rise at Center - 8-3/4" Axle
BB1146	1967	Power Disc - Right Front Line 4" Rise at Center - Dana Axle
BB1147	1967	Standard Disc - Right Front Routes Over Frame - 8-3/4" and Dana Axle - With Metering Valve (1 Pc. Front to Rear)
BB1149	1967	Standard Disc - Right Front Routes Under Frame - 8-3/4" and Dana Axle - With Metering Valve (1 Pc. Front to Rear)
BB1050	1968-69	Standard Drum Brake - Right Front Line Routes Under Frame - 7-1/4" Axle

# DODGE

Cont. from previous page

BB1051	1968-69	Standard Drum Brake - Right Front Line Routes Under Frame - 8-3/4" Axle
BB1052	1968-69	Standard Drum Brake - Right Front Line Routes Under Frame - Dana Axle
BB1054	1968-69	Standard Disc Brake - Right Front Line Routes Under Frame - 7-1/4" Axle
BB1055	1968-69	Standard Disc Brake - Right Front Line Routes Under Frame - 8-3/4" Axle
BB1056	1968-69	Standard Disc Brake - Right Front Line Routes Under Frame - Dana Axle
BB1058	1968-69	Standard Drum Brake - Right Front Line Routes Over Frame - 7-1/4" Axle
BB1059	1968-69	Standard Drum Brake - Right Front Line Routes Over Frame - 8-3/4" Axle
BB1060	1968-69	Standard Drum Brake - Right Front Line Routes Over Frame - Dana Axle
BB1062	1968-69	Standard Disc Brake - Right Front Line Routes Over Frame - 7-1/4" Axle
BB1063	1968-69	Standard Disc Brake - Right Front Line Routes Over Frame - 8-3/4" Axle
BB1064	1968-69	Standard Disc Brake - Right Front Line Routes Over Frame - Dana Axle
BB1066	1968-69	Power Drum Brake - Right Front Line Routes Under Frame - 7-1/4" Axle
BB1067	1968-69	Power Drum Brake & Hemi - Right Front Line Routes Under Frame - 8-3/4" Axle
BB1068	1968-69	Power Drum Brake & Hemi - Right Front Line Routes Under Frame - Dana Axle
BB1070	1968-69	Power Disc Brake - Right Front Line Routes Under Frame - 7-1/4" Axle
BB1071	1968-69	Power Disc Brake & Hemi - Right Front Line Routes Under Frame - 8-3/4" Axle
BB1072	1968-69	Power Disc Brake & Hemi - Right Front Line Routes Under Frame - Dana Axle
BB1074	1968-69	Power Drum Brake - Right Front Line Routes Over Frame - 7-1/4" Axle
BB1075	1968-69	Power Drum Brake & Hemi - Right Front Line Routes Over Frame - 8-3/4" Axle
BB1076	1968-69	Power Drum Brake & Hemi - Right Front Line Routes Over Frame - Dana Axle
BB1078	1968-69	Power Disc Brake - Right Front Line Routes Over Frame - 7-1/4" Axle
BB1079	1968-69	Power Disc Brake & Hemi - Right Front Line Routes Over Frame - 8-3/4" Axle
BB1080	1968-69	Power Disc Brake & Hemi - Right Front Line Routes Over Frame - Dana Axle
BB1090	1968-69	Power Disc - Right Front Line Routes Under Frame - Master Cylinder Right Ported - 7-1/4" Axle

BB1091	1968-69	Power Disc - Right Front Line Routes Under Frame - Master Cylinder Right Ported - 8-3/4" Axle
BB1092	1968-69	Power Disc - Right Front Routes Under Frame - Right Ported Master Cylinder - Dana Axle (2 Pc. Front to Rear) (1969 - Without Metering Valve)
BB1094	1968-69	Power Disc - Right Front Routes Over Frame - Right Ported Master Cylinder - 7-1/4" Axle (2 Pc. Front to Rear) (1969 - Without Metering Valve)
BB1095	1968-69	Power Disc - Right Front Routes Over Frame - Right Ported Master Cylinder - 8-3/4" Axle (2 Pc. Front to Rear) (1969 - Without Metering Valve)
BB1096	1968-69	Power Disc - Right Front Routes Over Frame - Right Ported Master Cylinder - Dana Axle (2 Pc. Front to Rear) (1969 - Without Metering Valve)
BB1129	1969	Standard Disc - Right Front Routes Over Frame - 8-3/4" Axle - With Metering Valve (1 Pc. Front to Rear)
BB1130	1969	Standard Disc - Right Front Routes Over Frame - 7-1/4" Axle - With Metering Valve (1 Pc. Front to Rear)
BB1131	1969	Standard Disc - Right Front Routes Under Frame - 8-3/4" Axle - With Metering Valve (1 Pc. Front to Rear)
BB1132	1969	Standard Disc - Right Front Routes Under Frame - 7-1/4" Axle - With Metering Valve (1 Pc. Front to Rear)
BB1133	1969	Power Disc - Right Front Routes Over Frame - 8-3/4" Axle - Left Ported Master Cylinder - With Metering Valve (2 Pc. Front to Rear)
BB1134	1969	Power Disc - Right Front Routes Over Frame - 7-1/4" Axle - Left Ported Master Cylinder - With Metering Valve (2 Pc. Front to Rear)
BB1135	1969	Power Disc - Right Front Routes Over Frame - 8-3/4" Axle - Right Ported Master Cylinder - With Metering Valve (2 Pc. Front to Rear)
BB1136	1969	Power Disc - Right Front Routes Over Frame - 7-1/4" Axle - Right Ported Master Cylinder - With Metering Valve (2 Pc. Front to Rear)
BB1137	1969	Power Disc - Right Front Routes Under Frame - 8-3/4" Axle - Left Ported Master Cylinder - With Metering Valve (2 Pc. Front to Rear)
BB1138	1969	Power Disc - Right Front Routes Under Frame - 7-1/4" Axle - Left Ported Master Cylinder - With Metering Valve (2 Pc. Front to Rear)
BB1139	1969	Power Disc - Right Front Routes Under Frame - 8-3/4" Axle - Right Ported Master Cylinder - With Metering Valve (2 Pc. Front to Rear)
BB1140	1969	Power Disc - Right Front Routes Under Frame - 7-1/4" Axle - Right Ported Master Cylinder - With Metering Valve (2 Pc. Front to Rear)
BB1169	1969	Standard Disc - Right Front Routes Over Frame - Dana Axle - With Metering Valve (1 Pc. Front to Rear)
BB1170	1969	Standard Disc - Right Front Routes Under Frame - Dana Axle - With Metering Valve (1 Pc. Front to Rear)
BB1171	1969	Power Disc - Right Front Routes Over Frame - Left Ported Master Cylinder - Dana Axle - With Metering Valve (2 Pc. Front to Rear)
BB1172	1969	Power Disc - Right Front Routes Over Frame - Right Ported Master Cylinder - Dana - With Metering Valve (2 Pc. Front to Rear)
BB1173	1969	Power Disc - Right Front Routes Under Frame - Left Ported Master Cylinder - Dana Axle - With Metering Valve (2 Pc. Front to Rear)
BB1174	1969	Power Disc - Right Front Routes Under Frame - Right Ported Master Cylinder - Dana Axle - With Metering Valve (2 Pc. Front to Rear)

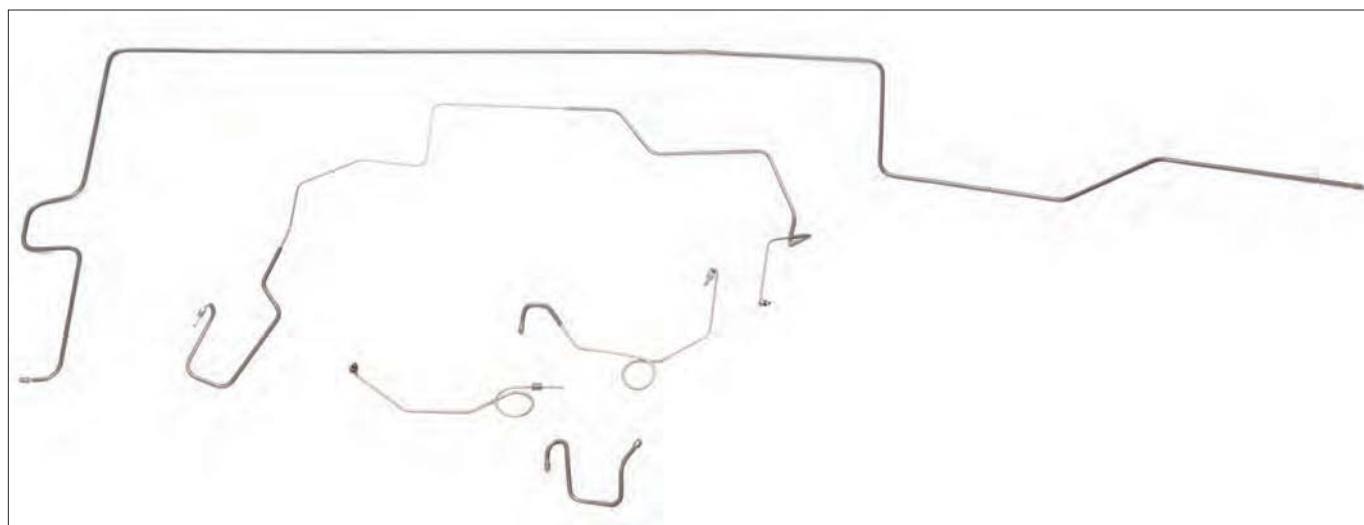

# DODGE

BB1148	1970	Power Disc - Right Front Line 4" Rise at Center - 8-3/4" Axle
BB1050	1970	Standard Drum Brake - Right Front Routes Under Frame - 7-1/4" Axle
BB1053	1970	Standard Drum Brake - Right Front Line Routes Under Frame - 8-3/4" and Dana Axle
BB1057	1970	Standard Disc Brake - Right Front Line Routes Under Frame - 8-3/4" and Dana Axle
BB1061	1970	Standard Disc Brake - Right Front Line Routes Over Frame - 8-3/4" and Dana Axle
BB1065	1970	Standard Drum Brake - Right Front Line Routes Over Frame - 8-3/4" and Dana Axle
BB1069	1970	Power Drum Brake & Hemi - Right Front Line Routes Under Frame - 8-3/4" and Dana Axle
BB1072	1970	Power Disc - Right Front Routes Under Frame - Left Ported Master Cylinder - Dana Axle (2 Pc. Front to Rear) (1969 - Without Metering Valve)
BB1073	1970	Power Disc Brake & Hemi - Right Front Line Routes Under Frame - 8-3/4" and Dana Axle
BB1077	1970	Power Drum Brake & Hemi - Right Front Line Routes Over Frame - 8-3/4" and Dana Axle
BB1081	1970	Power Disc Brake & Hemi - Right Front Line Routes Over Frame - 8-3/4" and Dana Axle
BB1093	1970	Power Disc - Right Front Routes Under Frame - Right Ported Master Cylinder - 8-3/4" and Dana Axle - Without Metering Valve (2 Pc. Front to Rear)
BB1097	1970	Power Disc - Right Front Line Routes Over Frame - Master Cylinder Right Ported- 8-3/4" and Dana Axle
BB1102	1970	Power Disc & Hemi - Right Front Line Routes Under Frame - Master Cylinder Left Ported - 8-3/4" and Dana Axle
BB1106	1970	Power Disc & Hemi- Right Front Routes Over Frame - Left Ported Master Cylinder - 8-3/4" and Dana Axle - Without Metering Valve (2 Pc. Front to Rear)
BB1143	1970	Power Disc - Right Front Line straight at Center - Dana Axle
BB1144	1970	Power Disc - Right Front Line 4" Rise at Center - 7-1/4" Axle
BB1151	1970	Power Disc - Right Front Routes Over Frame - Left Ported Master Cylinder - 8-3/4" and Dana Axle W/ Metering Valve (2 Pc. Front to Rear)
BB1152	1970	Power Disc - Right Front Routes Under Frame - Left Ported Master Cylinder - 7-1/4" Axle W/ Metering Valve
BB1153	1970	Power Disc - Right Front Routes Over Frame - Right Ported Master Cylinder - 8-3/4" and Dana Axle W/ Metering Valve (2 Pc. Front to Rear)
BB1155	1970	Power Disc - Right Front Routes Under Frame - Left Ported Master Cylinder - 8-3/4" and Dana Axle W/ Metering Valve (2 Pc. Front to Rear)
BB1157	1970	Power Disc - Right Front Routes Under Frame - Right Ported Master Cylinder - 8-3/4" and Dana Axle W/ Metering Valve (2 Pc. Front to Rear)
BB1158	1970	Standard Drum - Right Front Routes Over Frame 7-1/4" Axle
BB1107	1971	Standard Drum - 8-3/4" and Dana Axle
BB1110	1971	Power Drum - 8-3/4" and Dana Axle
BB1113	1971-72	Standard Disc - 8-3/4" and Dana Axle
BB1116	1971-72	Power Disc - 8-3/4" and Dana Axle
BB1121	1973	Standard Disc - 8-3/4" and Dana Axle
BB1122	1973	Power Disc - 8-3/4" and Dana Axle
BB1165	1974	Standard Disc - 8-3/4" and Dana Axle
BB1166	1974	Power Disc - 8-3/4" and Dana Axle

Fuel - Tank To Pump Line			Charger
Part No.	Year	Description	O.E. Steel Stainless Steel
BBF1004	1966-67	Big Block & Hemi - 3/8"	
BBR1004	1966-70	1/4"	
BBF1003	1967	Small Block - 5/16"	
BBR1002	1968-69	Big Block and Hemi - 1/4"	
BBF1005	1968-69	Small Block - 5/16"	
BBF1006	1968-69	Big Block & Hemi - 3/8"	
BBF1011	1970	Small Block - 5/16"	
BBF1012	1970	Big Block & Hemi - 3/8"	
BBF1007	1971-72	Small Block - 5/16"	
BBF1008	1971-72	Big Block & Hemi - 3/8"	
BBF1009	1973-74	Small Block - 5/16"	
DDF1025	2010	Tank to Pump Line	

Fuel - Return Line			Charger
Part No.	Year	Description	O.E. Steel Stainless Steel
BBR1002	1968-69	Big Block and Hemi - 1/4"	
BBR1004	1970	1/4"	
BBR1003	1973-74	1/4" (2 Pc.)	

Fuel - Vapor Line			Charger
Part No.	Year	Description	O.E. Steel Stainless Steel
BBV1001	1970	5/16" (2 Pc.)	
BBV1002	1971-72	5/16" (2 Pc.)	

Transmission Lines (Sold In Pairs)			Charger
Part No.	Year	Description	O.E. Steel Stainless Steel
BBT1001	1966-68	Big Block	
BBT1003	1966-70	Small Block	
BBT1012	1966-70	Small Block w/ 904 Torque Flite	
BBT1004	1969-70	Big Block - with Oil Filter at Radiator - Drivers Side	
BBT1011	1970	Hemi - with Aux Cooler (4 Pc.)	
BBT1015	1971	Small Block - with 727 Transmission	
BBT1005	1971-74	Small Block - 904 Transmission	
BBT1006	1971-74	Big Block - 727 Transmission	
BBT1008	1971-74	Hidden Headlights - Small Block	
BBT1013	1972-74	Hemi - 727 with Aux Cooler (4 Pc.)	

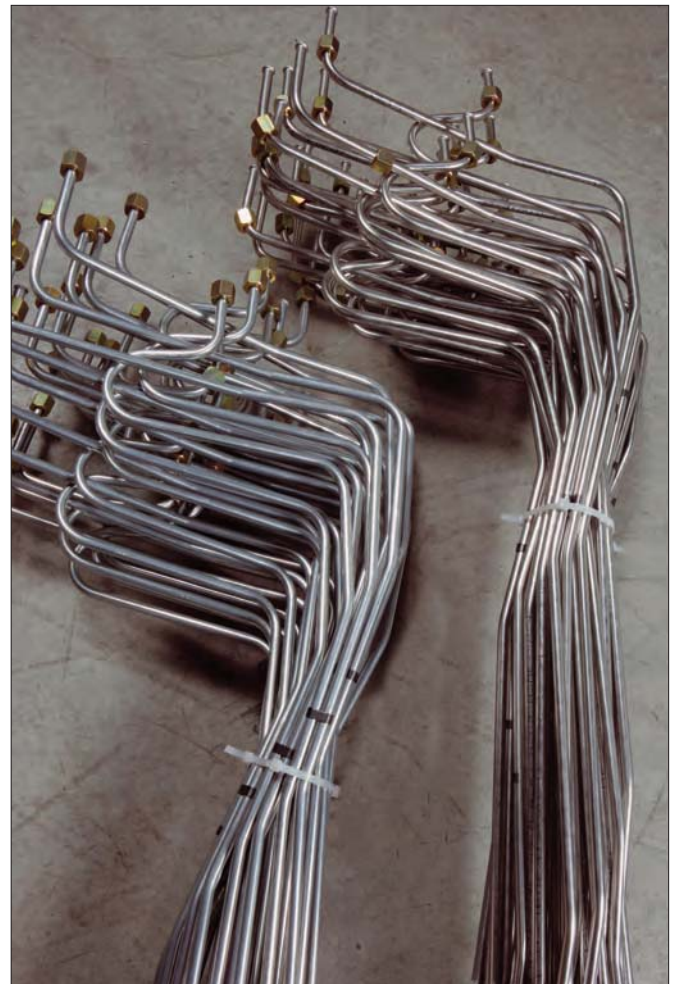

# DODGE

## CORONET

### Complete Brake Line Kit

Part No.	Year	Description	O.E. Steel	Stainless Steel
DD1001	1954	D-48		
BB1002	1962-65	Power Brake		
BB1175	1964	Standard Brake		
BB1001	1964-65	Standard Brake		
BB1003	1966	Standard Brake - Right Line Straight at Center - Drum - 7-1/4" Axle		
BB1004	1966	Standard Brake - Right Front Line Straight at Center - Drum - 8-3/4" Axle		
BB1005	1966	Standard Brake - Right Front Line Straight at Center - Drum - Dana Axle		
BB1009	1966	Standard Brake - Right Front Line 4" Rise at Center - Drum - 7-1/4" Axle		
BB1010	1966	Standard Brake - Right Front Line 4" Rise at Center - Drum - 8-3/4" Axle		
BB1011	1966	Standard Brake - Right Front Line 4" Rise at Center - Drum - Dana Axle		
BB1015	1966	Power Brake & Hemi - Right Front Line Straight at Center - Drum - 7-1/4" Axle		
BB1016	1966	Power Brake & Hemi - Right Front Line Straight at Center - Drum - 8-3/4" Axle		
BB1017	1966	Power Brake & Hemi - Right Front Line Straight at Center - Drum - Dana Axle		
BB1020	1966	Power Brake - Right Front Line 4" Rise at Center - 7-1/4" Axle		
BB1021	1966	Power Brake & Hemi - Right Front Line 4" Rise at Center - Drum - 8-3/4" Axle		
BB1022	1966	Power Brake & Hemi - Right Front Line 4" Rise at Center - Drum - Dana Axle		
BB1026	1967	Standard Drum Brake - Right Front Line Straight at Center - 7-1/4" Axle		
BB1027	1967	Standard Drum Brake - Right Front Line Straight at Center - 8-3/4" Axle		
BB1028	1967	Standard Drum Brake - Right Front Line Straight at Center - Dana Axle		
BB1029	1967	Standard Disc Brake - Right Front Line Straight at Center - 7-1/4" Axle		
BB1030	1967	Standard Disc Brake - Right Front Line Straight at Center - 8-3/4" Axle		
BB1031	1967	Standard Disc Brake - Right Front Line Straight at Center - Dana Axle		
BB1032	1967	Standard Drum Brake - Right Front Line 4" Rise at Center - 7-1/4" Axle		
BB1034	1967	Standard Drum Brake - Right Front Line 4" Rise at Center - Dana Axle		
BB1033	1967	Standard Drum - Right Front 4" Rise at Center - 8-3/4" Axle		
BB1035	1967	Standard Disc Brake - Right Front Line 4" Rise at Center - 7-1/4" Axle		
BB1036	1967	Standard Disc Brake - Right Front Line 4" Rise at Center - 8-3/4" Axle		
BB1037	1967	Standard Disc Brake - Right Front Line 4" Rise at Center - Dana Axle		
BB1038	1967	Power Drum Brake - Right Front Line Straight at Center - 7-1/4" Axle		
BB1039	1967	Power Drum Brake - Right Front Line Straight at Center - 8-3/4" Axle		
BB1040	1967	Power Drum Brake - Right Front Line Straight at Center - Dana Axle		
BB1041	1967	Power Disc Brake - Right Front Line Straight at Center - 7-1/4" Axle		
BB1042	1967	Power Disc Brake - Right Front Line Straight at Center - 8-3/4" Axle		
BB1043	1967	Power Disc - Right Front Straight at Center - Dana Axle (2 Pc. Front to Rear)		
BB1044	1967	Power Drum Brake - Right Front Line 4" Rise at Center - 7-1/4" Axle		
BB1045	1967	Power Drum Brake - Right Front Line 4" Rise at Center - 8-3/4" Axle		
BB1046	1967	Power Drum Brake - Right Front Line 4" Rise at Center - Dana Axle		
BB1047	1967	Power Disc Brake - Right Front Line 4" Rise at Center - 7-1/4" Axle		
BB1048	1967	Power Disc Brake - Right Front Line 4" Rise at Center - 8-3/4" Axle		
BB1049	1967	Power Disc Brake - Right Front Line 4" Rise at Center - Dana Axle		
BB1050	1968-69	Standard Drum Brake - Right Front Line Routes Under Frame - 7-1/4" Axle		
BB1051	1968-69	Standard Drum Brake - Right Front Line Routes Under Frame - 8-3/4" Axle		
BB1052	1968-69	Standard Drum Brake - Right Front Line Routes Under Frame - Dana Axle		

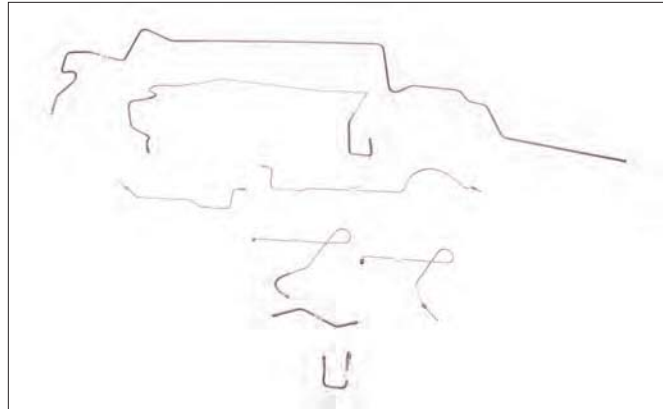

BB1054	1968-69	Standard Disc Brake - Right Front Line Routes Under Frame - 7-1/4" Axle
BB1055	1968-69	Standard Disc Brake - Right Front Line Routes Under Frame - 8-3/4" Axle
BB1056	1968-69	Standard Disc Brake - Right Front Line Routes Under Frame - Dana Axle
BB1058	1968-69	Standard Drum Brake - Right Front Line Routes Over Frame - 7-1/4" Axle
BB1059	1968-69	Standard Drum Brake - Right Front Line Routes Over Frame - 8-3/4" Axle
BB1060	1968-69	Standard Drum Brake - Right Front Line Routes Over Frame - Dana Axle
BB1062	1968-69	Standard Disc Brake - Right Front Line Routes Over Frame - 7-1/4" Axle
BB1063	1968-69	Standard Disc Brake - Right Front Line Routes Over Frame - 8-3/4" Axle
BB1064	1968-69	Standard Disc Brake - Right Front Line Routes Over Frame - Dana Axle
BB1066	1968-69	Power Drum Brake - Right Front Line Routes Under Frame - 7-1/4" Axle
BB1067	1968-69	Power Drum Brake & Hemi - Right Front Line Routes Under Frame - 8-3/4" Axle
BB1068	1968-69	Power Drum Brake & Hemi - Right Front Line Routes Under Frame - Dana Axle
BB1070	1968-69	Power Disc Brake - Right Front Line Routes Under Frame - 7-1/4" Axle
BB1071	1968-69	Power Disc Brake & Hemi - Right Front Line Routes Under Frame - 8-3/4" Axle
BB1072	1968-69	Power Disc Brake & Hemi - Right Front Line Routes Under Frame - Dana Axle
BB1074	1968-69	Power Drum Brake - Right Front Line Routes Over Frame - 7-1/4" Axle
BB1075	1968-69	Power Drum Brake & Hemi - Right Front Line Routes Over Frame - 8-3/4" Axle
BB1076	1968-69	Power Drum Brake & Hemi - Right Front Line Routes Over Frame - Dana Axle
BB1078	1968-69	Power Disc Brake - Right Front Line Routes Over Frame - 7-1/4" Axle
BB1079	1968-69	Power Disc Brake & Hemi - Right Front Line Routes Over Frame - 8-3/4" Axle
BB1080	1968-69	Power Disc Brake & Hemi - Right Front Line Routes Over Frame - Dana Axle
BB1090	1968-69	Power Disc - Right Front Line Routes Under Frame - Master Cylinder Right Ported - 7-1/4" Axle
BB1091	1968-69	Power Disc - Right Front Line Routes Under Frame - Master Cylinder Right Ported - 8-3/4" Axle
BB1092	1968-69	Power Disc - Right Front Line Routes Under Frame - Master Cylinder Right Ported - Dana Axle
BB1094	1968-69	Power Disc - Right Front Line Routes Over Frame - Master Cylinder Right Ported - 7-1/4" Axle
BB1095	1968-69	Power Disc - Right Front Line Routes Over Frame - Master Cylinder Right Ported - 8-3/4" Axle
BB1096	1968-69	Power Disc - Right Front Line Routes Over Frame - Master Cylinder Right Ported - Dana Axle

# DODGE

BB1129	1969	Standard Disc - Right Front Routes Over Frame - 8-3/4" Axle - With Metering Valve (1 Pc. Front to Rear)
BB1130	1969	Standard Disc - Right Front Routes Over Frame - 7-1/4" Axle - With Metering Valve (1 Pc. Front to Rear)
BB1131	1969	Standard Disc - Right Front Routes Under Frame - 8-3/4" Axle - With Metering Valve (1 Pc. Front to Rear)
BB1132	1969	Standard Disc - Right Front Routes Under Frame - 7-1/4" Axle - With Metering Valve (1 Pc. Front to Rear)
BB1133	1969	Power Disc - Right Front Routes Over Frame - 8-3/4" Axle - Left Ported Master Cylinder - With Metering Valve (2 Pc. Front to Rear)
BB1134	1969	Power Disc - Right Front Routes Over Frame - 7-1/4" Axle - Left Ported Master Cylinder - With Metering Valve (2 Pc. Front to Rear)
BB1136	1969	Power Disc - Right Front Routes Over Frame - 7-1/4" Axle - Right Ported Master Cylinder - With Metering Valve (2 Pc. Front to Rear)
BB1137	1969	Power Disc - Right Front Routes Under Frame - 8-3/4" Axle - Left Ported Master Cylinder - With Metering Valve (2 Pc. Front to Rear)
BB1138	1969	Power Disc - Right Front Routes Under Frame - 7-1/4" Axle - Left Ported Master Cylinder - With Metering Valve (2 Pc. Front to Rear)
BB1139	1969	Power Disc - Right Front Routes Under Frame - 8-3/4" Axle - Right Ported Master Cylinder - With Metering Valve (2 Pc. Front to Rear)
BB1140	1969	Power Disc - Right Front Routes Under Frame - 7-1/4" Axle - Right Ported Master Cylinder - With Metering Valve (2 Pc. Front to Rear)
BB1147	1970	Standard Disc - Right Front Routes Over Frame - 8-3/4" and Dana Axle - With Metering Valve (1 Pc. Front to Rear)
BB1148	1970	Power Disc - Right Front Line 4" Rise at Center - 8-3/4" Axle
BB1149	1970	Standard Disc - Right Front Routes Under Frame - 8-3/4" and Dana Axle - With Metering Valve (1 Pc. Front to Rear)
BB1050	1970	Standard Drum Brake - Right Front Routes Under Frame - 7-1/4" Axle
BB1053	1970	Standard Drum Brake - Right Front Line Routes Under Frame - 8-3/4" and Dana Axle
BB1057	1970	Standard Disc Brake - Right Front Line Routes Under Frame - 8-3/4" and Dana Axle
BB1061	1970	Standard Disc Brake - Right Front Line Routes Over Frame - 8-3/4" and Dana Axle
BB1065	1970	Standard Drum Brake - Right Front Line Routes Over Frame - 8-3/4" and Dana Axle
BB1069	1970	Power Drum Brake & Hemi - Right Front Line Routes Under Frame - 8-3/4" and Dana Axle
BB1073	1970	Power Disc Brake & Hemi - Right Front Line Routes Under Frame - 8-3/4" and Dana Axle
BB1077	1970	Power Drum Brake & Hemi - Right Front Line Routes Over Frame - 8-3/4" and Dana Axle
BB1081	1970	Power Disc Brake & Hemi - Right Front Line Routes Over Frame - 8-3/4" and Dana Axle

BB1093	1970	Power Disc - Right Front Routes Under Frame - Right Ported Master Cylinder - 8-3/4" and Dana Axle - Without Metering Valve (2 Pc. Front to Rear)
BB1097	1970	Power Disc - Right Front Routes Over Frame - Right Ported Master Cylinder - 8-3/4" and Dana Axle - Without Metering Valve (2 Pc. Front to Rear)
BB1102	1970	Power Disc & Hemi - Right Front Line Routes Under Frame - Master Cylinder Left Ported - 8-3/4" and Dana Axle
BB1106	1970	Power Disc & Hemi - Right Front Routes Over Frame - Left Ported Master Cylinder - 8-3/4" and Dana Axle - Without Metering Valve (2 Pc. Front to Rear)
BB1151	1970	Power Disc - Right Front Routes Over Frame - Left Ported Master Cylinder - 8-3/4" and Dana Axle - With Metering Valve (2 Pc. Front to Rear)
BB1153	1970	Power Disc - Right Front Routes Over Frame - Right Ported Master Cylinder - 8-3/4" and Dana Axle - With Metering Valve (2 Pc. Front to Rear)
BB1155	1970	Power Disc - Right Front Routes Under Frame - Left Ported Master Cylinder - 8-3/4" and Dana Axle - With Metering Valve (2 Pc. Front to Rear)
BB1157	1970	Power Disc - Right Front Routes Under Frame - Right Ported Master Cylinder - 8-3/4" and Dana Axle - With Metering Valve (2 Pc. Front to Rear)
BB1158	1970	Standard Drum - Right Front Routes Over Frame 7-1/4" Axle
BB1107	1971	Standard Drum - 8-3/4" and Dana Axle
BB1110	1971	Power Drum - 8-3/4" and Dana Axle
BB1113	1971-72	Standard Disc - 8-3/4" and Dana Axle
BB1116	1971-72	Power Disc - 8-3/4" and Dana Axle
BB1121	1973	Standard Disc - 8-3/4" and Dana Axle
BB1122	1973	Power Disc - 8-3/4" and Dana Axle
BB1165	1974	Standard Disc - 8-3/4" and Dana Axle
BB1166	1974	Power Disc - 8-3/4" and Dana Axle

### Fuel - Tank To Pump Line

Part No.	Year	Description	O.E. Steel	Coronet
BBF1001	1964-65	Small Block - 5/16"		
BBF1002	1965	Big Block and Hemi - 3/8"		
BBF1004	1966-67	Big Block & Hemi - 3/8"		
BBF1003	1967	Small Block - 5/16"		
BBF1005	1968-69	Small Block - 5/16"		
BBF1006	1968-69	Big Block & Hemi - 3/8"		
BBF1011	1970	Small Block - 5/16"		
BBF1012	1970	Big Block & Hemi - 3/8"		
BBF1007	1971-72	Small Block - 5/16"		
BBF1008	1971-72	Big Block & Hemi - 3/8"		
BBF1009	1973-74	Small Block - 5/16"		
BBF1010	1973-74	Big Block - 3/8"		

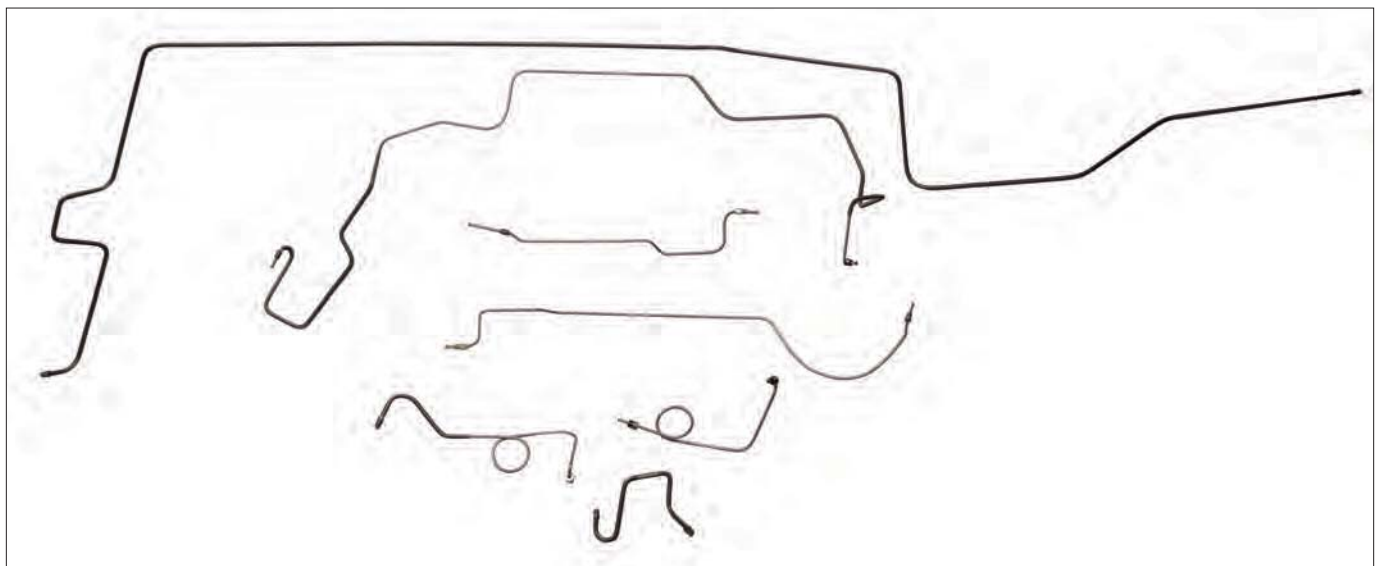

# DODGE

Fuel - Return Line			Coronet	
Part No.	Year	Description	O.E. Steel	Stainless Steel
BBR1002	1968-69	Big Block and Hemi - 1/4"		
BBR1004	1970	1/4"		
BBR1003	1973-74	1/4" (2 Pc.)		

Fuel - Vapor Line			Coronet	
Part No.	Year	Description	O.E. Steel	Stainless Steel
BBV1001	1970	5/16" (2 Pc.)		
BBV1002	1971-72	5/16" (2 Pc.)		

Transmission Lines (Sold In Pairs)			Coronet	
Part No.	Year	Description	O.E. Steel	Stainless Steel
BBT1007	1965	318 CID		
BBT1001	1966-68	Big Block		
BBT1003	1966-70	Small Block		
BBT1012	1966-71	Small Block w/ 727 Torque Flite		
BBT1002	1969	Transmission to Radiator - Radiator to Aux Cooler (4 Pc.)		
BBT1004	1969-70	Big Block - with Oil Filter at Radiator - Drivers Side		
BBT1011	1970	Hemi - with Aux Cooler (4 Pc.)		
BBT1015	1971	Small Block - with 727 Transmission		
BBT1005	1971-74	Small Block - 904 Transmission		
BBT1006	1971-74	Big Block - 727 Transmission		
BBT1008	1971-74	Hidden Headlights - Small Block		
BBT1010	1971-74	Small Block - A727 Transmission		

## DART

Complete Brake Line Kit			Dart	
Part No.	Year	Description	O.E. Steel	Stainless Steel
AB1049	1964-66	Wagon Drum - 106" WB		
AB1094	1964-66	Wagon Standard Drum - 106" Wheelbase 7-1/4" Axle		
AB1095	1964-66	Wagon Power Drum - 106" Wheelbase 7-1/4" Axle		
AB1042	1965-69	Power Disc - 111" WB - Proportioning Valve on Frame (2 Pc.) - 8-3/4" Axle		
AB1005	1967	Standard Drum - 111" WB - 7-1/4" Axle		
AB1006	1967	Standard Drum - 111" WB - 8-3/4" Axle		
AB1007	1967	Standard Disc - 111" WB - Proportioning Valve on Frame (2 Pc.) - 7-1/4" Axle		
AB1008	1967	Standard Disc - 111" WB - Proportioning Valve on Frame (2 Pc.)		
AB1015	1967	Power Drum - 111" WB - 7-1/4" Axle		
AB1016	1967	Power Drum - 111" WB - 8-3/4" Axle		

AB1017	1967	Power Disc - 111" WB - Proportioning Valve on Frame (2 Pc.) - 7-1/4" Axle
AB1018	1967	Power Disc - 111" WB - Proportioning Valve on Frame (2 Pc.) - 8-3/4" Axle
AB1042	1968-69	Power Disc - 111" Wheelbase 8-3/4" Axle (2 Pc. Front to Rear)
AB1051	1968-69	Standard Drum - 111" Wheelbase 8-3/4" Axle (1 Pc. Front to Rear)
AB1055	1968-69	Power Drum - 111" Wheelbase 8-3/4" Axle (1 Pc. Front to Rear)
AB1027	1968-70	Standard Disc - 111" WB - Proportioning Valve on Frame (2 Pc.) - 7-1/4" Axle
AB1028	1968-70	Standard Disc - 111" WB - Proportioning Valve on Frame (2 Pc.) - 8-3/4" Axle
AB1041	1968-70	Power Disc - 111" WB - Proportioning Valve on Frame (2 Pc.) - 7-1/4" Axle
AB1052	1968-70	Standard Drum - 111" Wheelbase 7-1/4" Axle (1 Pc. Front to Rear)
AB1056	1968-70	Power Drum - 111" Wheelbase 7-1/4" Axle (1 Pc. Front to Rear)
AB1034	1969-70	Standard Disc - 111" WB - Proportioning Valve Under seat - 8-3/4" Axle
AB1047	1969-70	Power Disc - 111" WB - Proportioning Valve Under Seat - 7-1/4" Axle
AB1048	1969-70	Power Disc - 111" WB - Proportioning Valve Under Seat - 8-3/4" Axle
AB1061	1970	Standard Drum - 111" Wheelbase 8-3/4" Axle (1 Pc. Front to Rear)
AB1063	1970	Power Drum - 111" Wheelbase 8-3/4" Axle (1 Pc. Front to Rear)
AB1066	1971	Standard Brake - 108" Wheelbase 8-3/4" Axle Inlet Tubes not Included but sold separately
AB1067	1971	Power Brake - 111" Wheelbase 8-3/4" Axle
AB1099	1971	Standard Brake - 111" Wheelbase 7-1/4" Axle
AB1101	1971	Power Brake - 111" Wheelbase 7-1/4" Axle
AB1025	1972	Standard Brakes - 111" WB - 7-1/4" Axle
AB1026	1972	Standard Brakes - 111" WB - 8-3/4" Axle
AB1039	1972	Power Brakes - 111" WB - 7-1/4" Axle
AB1040	1972	Power Brakes - 111" WB - 8-3/4" Axle
AB1078	1972	Standard Disc - 111" Wheelbase 8-3/4" Axle
AB1079	1972	Standard Disc - 108" Wheelbase 7-1/4" Axle
AB1083	1972	Power Disc - 111" Wheelbase 7-1/4" Axle
AB1043	1973	Sport Power Brakes - 108" WB - 8-3/4" Axle
AB1102	1973-74	Sport Power Brake - 108" Wheelbase 7-1/4" Axle
AB1103	1973-74	Sport Power Brake - 108" Wheelbase 8-1/4" Axle
AB1104	1973-74	Power Brake - 111" Wheelbase 8-1/4" Axle
AB1029	1973-76	Sport Standard Brakes - 108" WB - 8-3/4" Axle
AB1031	1973-76	Standard Brakes - 111" WB - 8-3/4" Axle
AB1045	1973-76	Power Brakes - 111" WB - 8-3/4" Axle
AB1030	1975-76	Sport Standard Brakes - 108" WB - 7-1/4" Axle
AB1046	1975-76	Power Brakes - 111" WB - 7-1/4" Axle
AB1046	1975-76	Power Drum - 111" Wheelbase 7-1/4" Axle
AB1047	1975-76	Power Disc - 111" Wheelbase 7-1/4" Axle

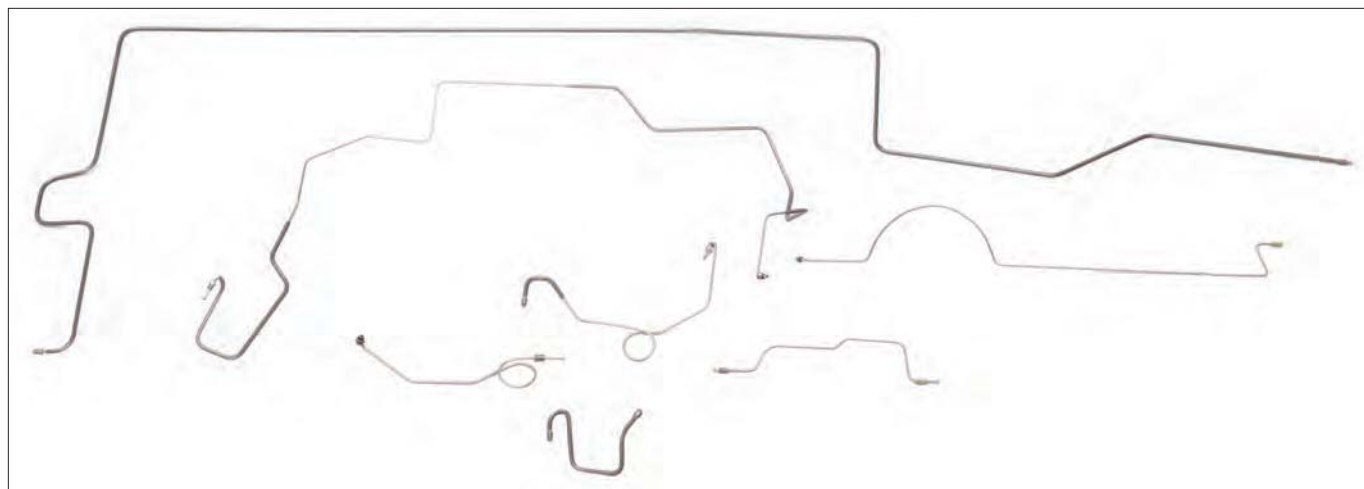

## DODGE

AB1090	1975-76	Sport Power Disc - 108" Wheelbase 7-1/4" Axle
AB1091	1975-76	Power Disc - 111" Wheelbase 7-1/4" Axle
AB1092	1975-76	Sport Standard Disc - 108" Wheelbase 7-1/4" Axle
AB1093	1975-76	Standard Disc -108" Wheelbase 7-1/4" Axle
AB1105	1975-76	Sport Power Drum - 108" Wheelbase 8-1/4" Axle
AB1106	1975-76	Power Drum - 111" Wheelbase 8-1/4" Axle
AB1107	1975-76	Sport Standard Disc - 108" Wheelbase 8-1/4" Axle
AB1108	1975-76	Sport Power Disc - 108" Wheelbase 8-1/4" Axle
AB1109	1975-76	Power Disc - 111" Wheelbase 8-1/4" Axle
AB1044	1976	Sport Power Brakes - 108" WB - 7-1/4" Axle

Fuel - Pump To Carburetor Line			Dart	
Part No.	Year	Description	O.E. Steel	Stainless Steel
ABC1001	1971-74	318 CID (2 pc.)		

Fuel - Tank To Pump Line			Dart	
Part No.	Year	Description	O.E. Steel	Stainless Steel
ABF1003	1967-68	111" WB 5/16"		
ABF1004	1967-68	111" WB 3/8"		
ABF1007	1969-72	111" WB 5/16"		
ABF1008	1969-72	111" WB 3/8"		
ABF1009	1973-76	Sport 108" WB 5/16"		
ABF1010	1973-76	Sport 108" WB 3/8"		
ABF1011	1973-76	111" WB 5/16"		
ABF1012	1973-76	111" WB 3/8"		
ABR1002	1973-76	111" WB (2 Pc.)		

Fuel - Return Line			Dart	
Part No.	Year	Description	O.E. Steel	Stainless Steel
ABR1001	1973-76	Sport 108" WB (2 Pc.)		

Fuel - Vapor Line			Dart	
Part No.	Year	Description	O.E. Steel	Stainless Steel
ABV1003	1972	111" WB		
ABV1002	1973-76	111" WB		

Transmission Lines (Sold In Pairs)			Dart	
Part No.	Year	Description	O.E. Steel	Stainless Steel
ABT1009	1964-66	6 Cylinder A904 Transmission		
ABT1002	1967-69	V8 - Dart Only		
ABT1004	1967-73	V8 A727 Transmission		
ABT1006	1968	Slant 6		
ABT1008	1969	273 CID		

## DAYTONA

Complete Brake Line Kit			Daytona	
Part No.	Year	Description	O.E. Steel	Stainless Steel
BB1051	1968-69	Standard Drum - Right Front Routes Under Frame - 8-3/4" Axle (1 Pc. Front to Rear)		
BB1052	1968-69	Standard Drum Brake - Right Front Line Routes Under Frame - Dana Axle		
BB1055	1968-69	Standard Disc Brake - Right Front Line Routes Over Frame - 8-3/4" Axle		
BB1056	1968-69	Standard Disc Brake - Right Front Line Routes Under Frame - Dana Axle		
BB1059	1968-69	Standard Drum Brake - Right Front Line Routes Over Frame - 8-3/4" Axle		
BB1060	1968-69	Standard Drum Brake - Right Front Line Routes Over Frame - Dana Axle		
BB1063	1968-69	Standard Disc Brake - Right Front Line Routes Over Frame - 8-3/4" Axle		
BB1064	1968-69	Standard Disc Brake - Right Front Line Routes Over Frame - Dana Axle		
BB1067	1968-69	Power Drum Brake & Hemi - Right Front Line Routes Under Frame - 8-3/4" Axle		
BB1068	1968-69	Power Drum Brake & Hemi - Right Front Line Routes Over Frame - Dana Axle		
BB1071	1968-69	Power Disc Brake & Hemi - Right Front Line Routes Under Frame - 8-3/4" Axle		



BB1072	1968-69	Power Disc Brake & Hemi - Right Front Line Routes Under Frame - Dana Axle		
BB1072	1968-69	Power Disc - Right Front Routes Under Frame - Left Ported Master Cylinder - Dana Axle (2 Pc. Front to Rear) (1969 - Without Metering Valve)		
BB1075	1968-69	Power Drum Brake & Hemi - Right Front Line Routes Over Frame - 8-3/4" Axle		
BB1076	1968-69	Power Drum Brake & Hemi - Right Front Line Routes Over Frame - Dana Axle		
BB1080	1968-69	Power Disc Brake & Hemi - Right Front Line Routes Over Frame - Dana Axle		
BB1080	1968-69	Power Disc - Right Front Routes Over Frame - Dana Axle - Left Ported Master Cylinder (2 Pc. Front to Rear) (1969 - Without Metering Valve)		
BB1091	1968-69	Power Disc - Right Front Line Routes Under Frame - Master Cylinder Right Ported - 8-3/4" Axle		
BB1092	1968-69	Power Disc - Right Front Line Routes Under Frame - Master Cylinder Right Ported - Dana Axle		
BB1095	1968-69	Power Disc - Right Front Routes Over Frame - Right Ported Master Cylinder - 8-3/4" Axle (2 Pc. Front to Rear) (1969 - Without Metering Valve)		
BB1096	1968-69	Power Disc - Right Front Line Routes Over Frame - Master Cylinder Right Ported - Dana Axle		
BB1079	1969	Power Disc Brake & Hemi - Right Front Line Routes Over Frame - 8-3/4" Axle		
BB1129	1969	Standard Disc - Right Front Routes Over Frame - 8-3/4" Axle - With Metering Valve (1 Pc. Front to Rear)		
BB1131	1969	Standard Disc - Right Front Routes Under Frame - 8-3/4" Axle - With Metering Valve (1 Pc. Front to Rear)		
BB1133	1969	Power Disc - Right Front Routes Over Frame - 8-3/4" Axle - Left Ported Master Cylinder - With Metering Valve (2 Pc. Front to Rear)		
BB1135	1969	Power Disc - Right Front Routes Over Frame - 8-3/4" Axle - Right Ported Master Cylinder - With Metering Valve (2 Pc. Front to Rear)		
BB1135	1969	Power Disc - Right Front Routes Over Frame - 8-3/4" Axle - Right Ported Master Cylinder - With Metering Valve (2 Pc. Front to Rear)		
BB1137	1969	Power Disc - Right Front Routes Under Frame - 8-3/4" Axle - Left Ported Master Cylinder - With Metering Valve (2 Pc. Front to Rear)		
BB1139	1969	Power Disc - Right Front Routes Under Frame - 8-3/4" Axle - Right Ported Master Cylinder - With Metering Valve (2 Pc. Front to Rear)		
BB1139	1969	Power Disc - Right Front Routes Under Frame - 8-3/4" Axle - Right Ported Master Cylinder - With Metering Valve (2 Pc. Front to Rear)		
BB1169	1969	Standard Disc - Right Front Routes Over Frame - Dana Axle - With Metering Valve (1 Pc. Front to Rear)		
BB1170	1969	Standard Disc - Right Front Routes Under Frame - Dana Axle - With Metering Valve (1 Pc. Front to Rear)		
BB1171	1969	Power Disc - Right Front Routes Over Frame - Left Ported Master Cylinder - Dana Axle - With Metering Valve (2 Pc. Front to Rear)		
BB1172	1969	Power Disc - Right Front Routes Over Frame - Right Ported Master Cylinder - Dana - With Metering Valve (2 Pc. Front to Rear)		
BB1173	1969	Power Disc - Right Front Routes Under Frame - Left Ported Master Cylinder - Dana Axle - With Metering Valve (2 Pc. Front to Rear)		
BB1174	1969	Power Disc - Right Front Routes Under Frame - Right Ported Master Cylinder - Dana Axle - With Metering Valve (2 Pc. Front to Rear)		
CY1022	1987-89			

# DODGE

### Fuel - Tank To Pump Line Daytona

Part No.	Year	Description	O.E. Steel	Stainless Steel
BBF1005	1968-69	Small Block - 5/16"		
BBF1006	1968-69	Big Block & Hemi - 3/8"		
DDF1013	1986	Turbo Z 2.2 Liter MPFI (2 Pc.)		

### Fuel - Return Line Daytona

Part No.	Year	Description	O.E. Steel	Stainless Steel
BBR1002	1968-69	Big Block and Hemi - 1/4"		
DDR1008	1986	Turbo Z 2.2 Liter MPFI		

### Fuel - Vapor Line Daytona

Part No.	Year	Description	O.E. Steel	Stainless Steel
DDV1009	1986	Turbo Z 2.2 Liter MPFI		

### Transmission Lines (Sold In Pairs) Daytona

Part No.	Year	Description	O.E. Steel	Stainless Steel
BBT1002	1969	Transmission to Radiator - Radiator to Aux Cooler (4 Pc.)		
BBT1004	1969	Big Block - with Oil Filter at Radiator - Drivers Side		

## SUPER BEE

### Complete Brake Line Kit Super Bee

Part No.	Year	Description	O.E. Steel	Stainless Steel
BB1051	1968-69	Standard Drum Brake - Right Front Line Routes Under Frame - 8-3/4" Axle		
BB1052	1968-69	Standard Drum Brake - Right Front Line Routes Under Frame - Dana Axle		
BB1055	1968-69	Standard Disc Brake - Right Front Line Routes Under Frame - 8-3/4" Axle		
BB1056	1968-69	Standard Disc Brake - Right Front Line Routes Under Frame - Dana Axle		
BB1059	1968-69	Standard Drum Brake - Right Front Line Routes Over Frame - 8-3/4" Axle		

BB1060	1968-69	Standard Drum Brake - Right Front Line Routes Over Frame - Dana Axle
BB1063	1968-69	Standard Disc Brake - Right Front Line Routes Over Frame - 8-3/4" Axle
BB1064	1968-69	Standard Disc Brake - Right Front Line Routes Over Frame - Dana Axle
BB1067	1968-69	Power Drum Brake & Hemi - Right Front Line Routes Under Frame - 8-3/4" Axle
BB1068	1968-69	Power Drum Brake & Hemi - Right Front Line Routes Under Frame - Dana Axle
BB1071	1968-69	Power Disc Brake & Hemi - Right Front Line Routes Under Frame - 8-3/4" Axle
BB1072	1968-69	Power Disc Brake & Hemi - Right Front Line Routes Under Frame - Dana Axle
BB1075	1968-69	Power Drum Brake & Hemi - Right Front Line Routes Over Frame - 8-3/4" Axle
BB1076	1968-69	Power Drum Brake & Hemi - Right Front Line Routes Over Frame - Dana Axle
BB1079	1968-69	Power Disc Brake & Hemi - Right Front Line Routes Over Frame - 8-3/4" Axle
BB1080	1968-69	Power Disc Brake & Hemi - Right Front Line Routes Over Frame - Dana Axle
BB1091	1968-69	Power Disc - Right Front Line Routes Under Frame - Master Cylinder Right Ported - 8-3/4" Axle
BB1092	1968-69	Power Disc - Right Front Line Routes Under Frame - Master Cylinder: Right ported - Dana Axle
BB1092	1968-69	Power Disc - Right Front Routes Under Frame - Right Ported Master Cylinder - Dana Axle (2 Pc. Front to Rear) (1969 - Without Metering Valve)
BB1094	1968-69	Power Disc - Right Front Line Routes Over Frame - Master Cylinder Right Ported - 7-1/4" Axle
BB1095	1968-69	Power Disc - Right Front Line Routes Over Frame - Master Cylinder Right Ported - 8-3/4" Axle
BB1095	1968-69	Power Disc - Right Front Routes Over Frame - Right Ported Master Cylinder - 8-3/4" Axle (2 Pc. Front to Rear) (1969 - Without Metering Valve)
BB1096	1968-69	Power Disc - Right Front Line Routes Over Frame - Master Cylinder Right Ported - Dana Axle
BB1096	1968-69	Power Disc - Right Front Routes Over Frame - Right Ported Master Cylinder - Dana Axle (2 Pc. Front to Rear) (1969 - Without Metering Valve)

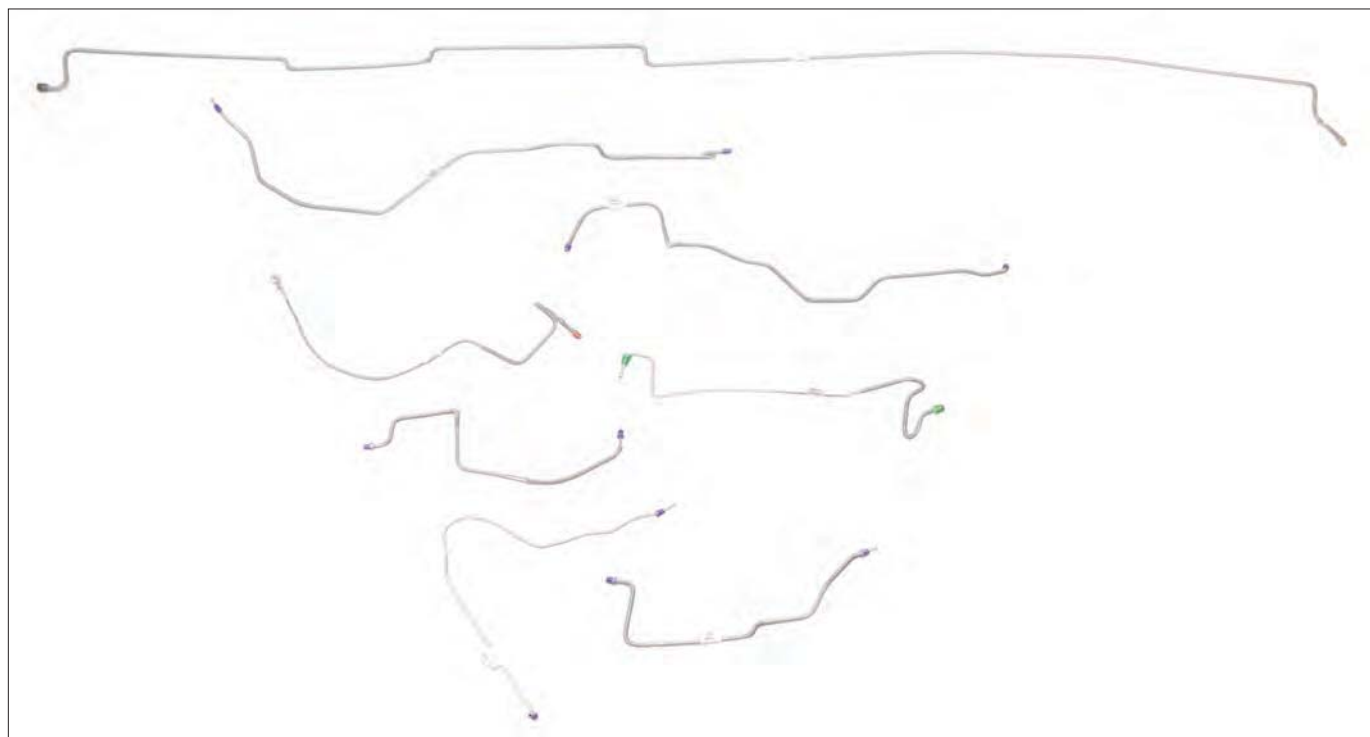

## DODGE

BB1129	1969	Standard Disc - Right Front Routes Over Frame - 8-3/4" Axle - With Metering Valve (1 Pc. Front to Rear)
BB1131	1969	Standard Disc - Right Front Routes Under Frame - 8-3/4" Axle - With Metering Valve (1 Pc. Front to Rear)
BB1133	1969	Power Disc - Right Front Routes Over Frame - 8-3/4" Axle - Left Ported Master Cylinder - With Metering Valve (2 Pc. Front to Rear)
BB1135	1969	Power Disc - Right Front Routes Over Frame - 8-3/4" Axle - Right Ported Master Cylinder - With Metering Valve (2 Pc. Front to Rear)
BB1137	1969	Power Disc - Right Front Routes Under Frame - 8-3/4" Axle - Left Ported Master Cylinder - With Metering Valve (2 Pc. Front to Rear)
BB1139	1969	Power Disc - Right Front Routes Under Frame - 8-3/4" Axle - Right Ported Master Cylinder - With Metering Valve (2 Pc. Front to Rear)
BB1169	1969	Standard Disc - Right Front Routes Over Frame - Dana Axle - With Metering Valve (1 Pc. Front to Rear)
BB1170	1969	Standard Disc - Right Front Routes Under Frame - Dana Axle - With Metering Valve (1 Pc. Front to Rear)
BB1171	1969	Power Disc - Right Front Routes Over Frame - Left Ported Master Cylinder - Dana Axle - With Metering Valve (2 Pc. Front to Rear)
BB1172	1969	Power Disc - Right Front Routes Over Frame - Right Ported Master Cylinder - Dana - With Metering Valve (2 Pc. Front to Rear)
BB1173	1969	Power Disc - Right Front Routes Under Frame - Left Ported Master Cylinder - Dana Axle - With Metering Valve (2 Pc. Front to Rear)
BB1174	1969	Power Disc - Right Front Routes Under Frame - Right Ported Master Cylinder - Dana Axle - With Metering Valve (2 Pc. Front to Rear)
BB1053	1970	Standard Drum Brake - Right Front Line Routes Under Frame - 8-3/4" and Dana Axle
BB1057	1970	Standard Disc Brake - Right Front Line Routes Under Frame - 8-3/4" and Dana Axle
BB1061	1970	Standard Disc Brake - Right Front Line Routes Over Frame - 8-3/4" and Dana Axle
BB1065	1970	Standard Drum Brake - Right Front Line Routes Over Frame - 8-3/4" and Dana Axle
BB1069	1970	Power Drum Brake & Hemi - Right Front Line Routes Under Frame - 8-3/4" and Dana Axle
BB1073	1970	Power Disc Brake & Hemi - Right Front Line Routes Under Frame - 8-3/4" and Dana Axle
BB1077	1970	Power Drum Brake & Hemi - Right Front Line Routes Over Frame - 8-3/4" and Dana Axle
BB1081	1970	Power Disc Brake & Hemi - Right Front Line Routes Over Frame - 8-3/4" and Dana Axle
BB1085	1970	Power Disc - Right Front Routes Under Frame - 8-3/4" and Dana Axle - Left Ported Master Cylinder - without Metering Valve (2 Pc. Front to Rear)
BB1093	1970	Power Disc - Right Front Line Routes Under Frame - Master Cylinder Right Ported - 8-3/4" and Dana Axle
BB1097	1970	Power Disc - Right Front Line Routes Over Frame - Master Cylinder Right Ported - 8-3/4" and Dana Axle
BB1147	1970	Standard Disc - Right Front Routes Over Frame - 8-3/4" and Dana Axle - With Metering Valve (1 Pc. Front to Rear)
BB1149	1970	Standard Disc - Right Front Routes Under Frame - 8-3/4" and Dana Axle - With Metering Valve (1 Pc. Front to Rear)
BB1151	1970	Power Disc - Right Front Routes Over Frame - Left Ported Master Cylinder - 8-3/4" and Dana Axle - With Metering Valve (2 Pc. Front to Rear)
BB1153	1970	Power Disc - Right Front Routes Over Frame - Right Ported Master Cylinder - 8-3/4" and Dana Axle - With Metering Valve (2 Pc. Front to Rear)
BB1155	1970	Power Disc - Right Front Routes Under Frame - Left Ported Master Cylinder - 8-3/4" and Dana Axle - With Metering Valve (2 Pc. Front to Rear)
BB1157	1970	Power Disc - Right Front Routes Under Frame - Right Ported Master Cylinder - 8-3/4" and Dana Axle - With Metering Valve (2 Pc. Front to Rear)
BB1107	1971	Standard Drum - 8-3/4" and Dana Axle
BB1110	1971	Power Drum - 8-3/4" and Dana Axle
BB1113	1971	Standard Disc - 8-3/4" and Dana Axle
BB1116	1971	Power Disc - 8-3/4" and Dana Axle

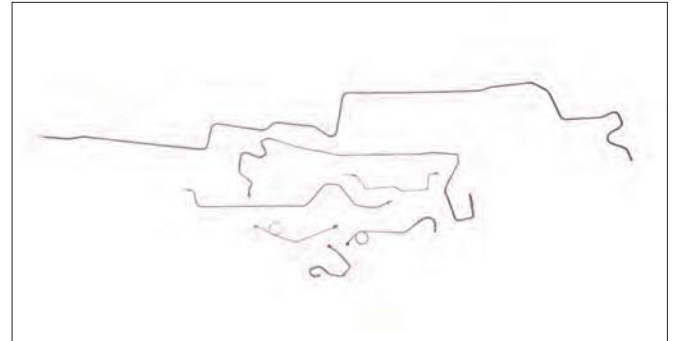

### Fuel - Return Line

Part No.	Year	Description	O.E. Steel	Stainless Steel
BBR1002	1968-69	Big Block and Hemi - 1/4"		
BBR1004	1970	1/4"		

### Fuel - Vapor Line

Part No.	Year	Description	O.E. Steel	Stainless Steel
BBV1001	1970	5/16" (2 Pc.)		
BBV1002	1971	5/16" (2 Pc.)		

### Transmission Lines (Sold In Pairs)

Part No.	Year	Description	O.E. Steel	Stainless Steel
BBT1002	1969	Transmission to Radiator - Radiator to Aux Cooler (4 Pc.)		
BBT1004	1969-70	Big Block - with Oil Filter at Radiator - Drivers Side		
BBT1001	1970	Big Block		
BBT1011	1970	Hemi - with Aux Cooler (4 Pc.)		
BBT1005	1971	Small Block - 904 Transmission		
BBT1015	1971	Small Block - with 727 Transmission		
BBT1006	1971-74	Big Block - 727 Transmission		
BBT1008	1971-74	Hidden Headlights - Small Block		
BBT1010	1971-74	Small Block - A727 Transmission		
BBT1013	1972-74	Hemi - 727 with Aux Cooler (4 Pc.)		

## SWINGER

### Complete Brake Line Kit

Part No.	Year	Description	O.E. Steel	Stainless Steel
AB1027	1968-70	Standard Disc - 111" WB - Proportioning Valve on Frame (2 Pc.) - 7-1/4" Axle		
AB1041	1968-70	Power Disc - 111" WB - Proportioning Valve on Frame (2 Pc.) - 7-1/4" Axle		
AB1042	1968-70	Power Disc - 111" WB - Proportioning Valve on Frame (2 Pc.) - 8-3/4" Axle		
AB1028	1969	Standard Disc - 111" WB - Proportioning Valve on Frame (2 Pc.) - 8-3/4" Axle		
AB1042	1969	Power Disc - 111" Wheelbase 8-3/4" Axle (2 Pc. Front to Rear)		
AB1051	1969	Standard Drum - 111" Wheelbase 8-3/4" Axle (1 Pc. Front to Rear)		
AB1055	1969	Power Drum - 111" Wheelbase 8-3/4" Axle (1 Pc. Front to Rear)		
AB1034	1969-70	Standard Disc - 111" WB - Proportioning Valve Under seat - 8-3/4" Axle		
AB1048	1969-70	Power Disc - 111" WB - Proportioning Valve Under Seat - 8-3/4" Axle		
AB1052	1969-70	Standard Drum - 111" Wheelbase 7-1/4" Axle (1 Pc. Front to Rear)		
AB1056	1969-70	Power Drum - 111" Wheelbase 7-1/4" Axle (1 Pc. Front to Rear)		
AB1061	1970	Standard Drum - 111" Wheelbase 8-3/4" Axle (1 Pc. Front to Rear)		
AB1063	1970	Power Drum - 111" Wheelbase 8-3/4" Axle (1 Pc. Front to Rear)		
AB1066	1971	Standard Brake - 108" Wheelbase 8-3/4" Axle Inlet Tubes not Included but sold separately		
AB1067	1971	Power Brake - 111" Wheelbase 8-3/4" Axle		
AB1099	1971	Standard Brake - 111" Wheelbase 7-1/4" Axle		
AB1040	1972	Power Brakes - 111" WB - 8-3/4" Axle		
AB1078	1972	Standard Disc - 111" Wheelbase 8-3/4" Axle		

### Fuel - Tank To Pump Line

Part No.	Year	Description	O.E. Steel	Stainless Steel
BBF1005	1968-69	Small Block - 5/16"		
BBF1006	1968-69	Big Block & Hemi - 3/8"		
BBF1011	1970	Small Block - 5/16"		
BBF1012	1970	Big Block & Hemi - 3/8"		
BBF1008	1971	Big Block & Hemi - 3/8"		

# DODGE

Cont. from previous page

AB1079	1972	Standard Disc -108" Wheelbase 7-1/4" Axle
AB1083	1972	Power Disc - 111" Wheelbase 7-1/4" Axle
AB1025	1973-74	Standard Brakes - 111" WB - 7-1/4" Axle
AB1026	1973-74	Standard Brakes - 111" WB - 8-3/4" Axle
AB1039	1973-74	Power Brakes - 111" WB - 7-1/4" Axle
AB1091	1975-76	Power Disc - 111" Wheelbase 7-1/4" Axle
AB1093	1975-76	Standard Disc -108" Wheelbase 7-1/4" Axle
AB1046	1976	Power Brakes - 111" WB - 7-1/4" Axle

Fuel - Tank To Pump Line			Swinger	
Part No.	Year	Description	O.E. Steel	Stainless Steel
ABF1007	1969-72	111" WB 5/16"		
ABF1008	1969-72	111" WB 3/8"		
ABF1009	1973-76	108" WB 5/16"		
ABF1010	1973-76	108" WB 3/8"		
ABF1011	1973-76	111" WB 5/16"		
ABF1012	1973-76	111" WB 3/8"		

Fuel - Return Line			Swinger	
Part No.	Year	Description	O.E. Steel	Stainless Steel
ABR1002	1973-76	111" WB (2 Pc.)		

Fuel - Vapor Line			Swinger	
Part No.	Year	Description	O.E. Steel	Stainless Steel
ABV1003	1972	111" WB		
ABV1002	1973-76	111" WB		

## DODGE TRUCK

Complete Brake Line Kit			Dodge Truck	
Part No.	Year	Description	O.E. Steel	Stainless Steel
DD1016	1929	Truck		
DD1028	1970	W200 Power Wagon Power Drum		
DD1007	1974-80	1500 4WD Ramcharger		
DD1087	1974-80	1500 2WD Ramcharger		
DD1034	1980-83	1500 4WD		
DD1008	1981-87	1500 4WD Longbed		
DD1039	1981-87	1500 4WD Shortbed		
DD1040	1981-87	1500 2WD Longbed		
DD1041	1981-87	1500 2WD Shortbed		
DD1088	1981-88	1500 2WD Ramcharger		
DD1089	1981-88	1500 4WD Shortbed 9.25 Axle		
DD1090	1981-88	1500 4WD Longbed 9.25 Axle		
DD1091	1981-88	1500 2WD Longbed 8.25 Axle		
DD1099	1981-88	3500 4WD Longbed Dana 60 Axle		
DD1099	1981-88	2500 4WD Longbed Dana 60 Axle		
DD1100	1981-88	2500 4WD Longbed 9.25 Axle		
DD1015	1984-87	Ramcharger 4WD		
DD1018	1985	1500 2WD Shortbed		
DD1019	1989	W350 4WD 131" WB Dana 60 Axle With ABS		
DD1092	1989-92	1500 4WD Longbed 8.25 Axle		
DD1093	1989-92	1500 4WD Longbed 9.25 Axle		
DD1094	1989-92	1500 2WD Longbed 9.25 Axle		
DD1101	1989-92	2500 4WD Longbed 9.25 Axle		
DD1030	1990	D150 2WD Longbed 1500 318 CID		
DD1053	1990	Dakota 2WD Standard Cab Shortbed Rear ABS		
DD1029	1993	Dakota 1500 2WD Regular Cab Shortbed Rear ABS, V8		
DD1031	1993	Dakota 1500 2WD Rear ABS Extended Cab Shortbed V8		
DD1056	1993	3500 4WD Longbed With Dana 60 Axle		
DD1056	1993	2500 4WD Longbed With Dana 60 Axle		
DD1095	1993	1500 4WD Longbed 8.25 Axle		
DD1096	1993	1500 4WD Longbed 9.25 Axle		
DD1097	1993	1500 2WD Longbed 8.25 Axle		

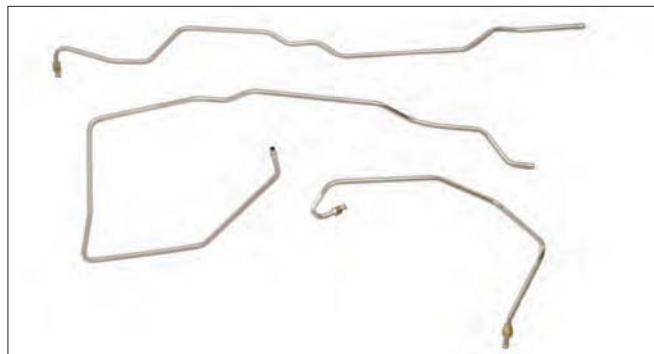

DD1098	1993	1500 2WD Longbed 9.25 Axle
DD1102	1993	2500 4WD Longbed 9.25 Axle
DD1068	1993-96	Dakota 1500 4WD Regular Cab Shortbed 4 Wheel ABS
DD1103	1993-96	Dakota 1500 4WD Extended Cab Shortbed 4 Wheel ABS
DD1058	1994	2500 4WD Regular Cab Longbed Rear ABS
DD1109	1994	3500 4WD Regular Cab Longbed Rear ABS Dual Rear Wheels
DD1021	1996-97	3500 4WD Extended Cab Longbed Rear ABS
DD1037	1996-97	2500 4WD Regular Cab Longbed 4 Wheel ABS
DD1045	1996-97	2500 4WD Regular Cab Longbed Rear ABS
DD1046	1996-97	3500 4WD Extended Cab Longbed 4 Wheel ABS
DD1049	1996-97	1500 4WD Regular Cab Shortbed Rear ABS
DD1062	1996-97	1500 4WD Regular Cab Shortbed 4 Wheel ABS
DD1069	1996-97	2500 4WD Regular Cab Longbed 4 Wheel ABS - With Rear Height Sensing Valve (2 Pc. Front to Rear)
DD1071	1996-97	2500 4WD Regular Cab Longbed Rear ABS - With Rear Height Sensing Valve (2 Pc. Front to Rear)
DD1035	1997	1500 Dakota 4WD Extended Cab Shortbed 8-1/4 Axle
DD1086	1997	1500 Dakota 2WD Extended Cab Shortbed Rear ABS
DD1107	1997	1500 4WD Extended Cab Shortbed Rear ABS
DD1020	1998	Dakota 2WD Regular Cab Shortbed With Rear ABS
DD1059	1998	Dakota 4WD Regular Cab Shortbed With Rear ABS
DD1054	1998-99	1500 4WD Quad Cab Shortbed Rear ABS
DD1066	1998-99	1500 4WD Quad Cab Shortbed 4 Wheel ABS
DD1105	1998-99	Dakota 1500 4WD Extended Cab Shortbed Rear ABS
DD1055	2000	1500 Dakota 4WD Extended Cab 6-1/2' Bed Rear ABS
DD1085	2000	1500 Dakota 2WD Extended Cab 6-1/2' Bed Rear ABS
DD1050	2000-01	2500 4WD Quadcab Longbed 4 Wheel ABS Rear Drum Brakes
DD1051	2000-01	2500 4WD Regular Cab Longbed 4 Wheel ABS Rear Drum Brakes (10 Pc.)
DD1060	2000-01	1500 4WD Regular Cab Longbed 4 Wheel ABS
DD1063	2000-01	1500 4WD Regular Cab Longbed Rear ABS
DD1064	2000-01	2500 4WD Quad Cab Longbed Rear ABS Rear Drum Brakes
DD1065	2000-01	2500 4WD Regular Cab Longbed Rear ABS Rear Drum Brakes
DD1072	2000-01	2500 4WD Quadcab Longbed 4 Wheel ABS - With Rear Height Sensing Valve (2 Pc. Front to Rear) Rear Drum Brakes
DD1073	2000-01	2500 4WD Regular Cab Longbed 4 Wheel ABS - With Rear Height Sensing Valve (2 Pc. Front to Rear) Rear Drum Brakes
DD1074	2000-01	2500 4WD Quad Cab Longbed Rear ABS - With Rear Height Sensing Valve (2 Pc. Front to Rear) Rear Drum Brakes
DD1075	2000-01	2500 4WD Regular Cab Longbed Rear ABS - With Rear Height Sensing Valve (2 Pc. Front to Rear) Rear Drum Brakes
DD1077	2000-01	2500 4WD Quadcab Longbed 4 Wheel ABS Rear Disc Brakes
DD1078	2000-01	2500 4WD Regular Cab Longbed 4 Wheel ABS Rear Disc Brakes (10 Pc.)
DD1079	2000-01	2500 4WD Quad Cab Longbed Rear ABS Rear Disc Brakes
DD1080	2000-01	2500 4WD Regular Cab Longbed Rear ABS Rear Disc Brakes
DD1081	2000-01	2500 4WD Quadcab Longbed 4 Wheel ABS - With Rear Height Sensing Valve (2 Pc. Front to Rear) Rear Disc Brakes
DD1082	2000-01	2500 4WD Regular Cab Longbed 4 Wheel ABS - With Rear Height Sensing Valve (2 Pc. Front to Rear) Rear Disc Brakes

# DODGE

DD1083	2000-01	2500 4WD Quad Cab Longbed Rear ABS - With Rear Height Sensing Valve (2 Pc. Front to Rear) Rear Disc Brakes
DD1084	2000-01	2500 4WD Regular Cab Longbed Rear ABS - With Rear Height Sensing Valve (2 Pc. Front to Rear) Rear Disc Brakes
DD1106	2000-01	1500 4WD Regular Cab Shortbed Rear ABS
DD1108	2000-01	2500 4WD Quadcab Shortbed 4 Wheel ABS Rear Drum Brakes
DD1111	2000-01	2500 4WD Quadcab Shortbed 4 Wheel ABS Rear Disc Brakes

Fuel - Pump To Carburetor Line			Dodge Truck	
Part No.	Year	Description	O.E. Steel	Stainless Steel
DDC1001	1954	D-48		
DDF1002	1957	Power Wagon		
DDF1016	1974-80	4WD Shortbed		
DDC1002	1977	Van - B200 318 CID		
DDF1010	1979	Little Red Express Shortbed Power Disc		
DDF1012	1981	Ramcharger (2 Pc.)		
DDC1003	1981-86	1500 V8 (2 Pc.)		
DDF1003	1984-86	1500 4WD Shortbed (2 Pc.)		
DDF1004	1987	1500 4WD Longbed (2 Pc.)		
DDF1005	1989	4WD 131" WB		
DDF1009	1989	1500 2WD Longbed - Filter to Engine		
DDF1008	1990	D150 2WD Longbed 318 CID - Fuel Injected		
DDF1017	1990	Dakota 2WD Standard Cab Shortbed Rear ABS (2 Pc.)		
DDF1007	1993	Dakota 2WD		
DDF1019	1994-96	2500 4WD Regular Cab Longbed V8 Gas Motor		
DDF1018	1995	2500 4WD Standard Cab Longbed Diesel Engine		

Fuel - Tank to Pump Line			Dodge Truck	
Part No.	Year	Description	O.E. Steel	Stainless Steel
DDF1026	1974	1500 Tank to Pump Line		
DDF1022	1996-97	2500 4WD Extended Cab Longbed Turbo Diesel		
DDF1022	1996-97	3500 4WD Extended Cab Longbed Turbo Diesel		

Fuel - Return Line			Dodge Truck	
Part No.	Year	Description	O.E. Steel	Stainless Steel
DDF1006	1970	W200 Power Wagon (2 Pc.)		
DDR1001	1984-86	1500 4WD Shortbed (2 Pc.)		
DDR1002	1987	1500 4WD Longbed (2 Pc.) Ram		
DDR1003	1989	4WD 131" WB		
DDR1006	1989	1500 2WD Longbed - Union to Engine		
DDR1005	1990	D150 2WD 318 CID Longbed - Fuel Injected		
DDR1009	1990	Dakota 2WD Standard Cab Shortbed Rear ABS		
DDR1007	1991	Ramcharger (2 Pc.)		
DDF1023	1992	1500 W250		
DDR1004	1993	Dakota 2WD		
DDR1010	1995	2500 4WD Standard Cab Longbed Diesel Engine		

Fuel - Vapor Line			Dodge Truck	
Part No.	Year	Description	O.E. Steel	Stainless Steel
DDV1011	1974-80	4WD Shortbed		
DDV1007	1979	Little Red Express Shortbed Power Disc		
DDV1001	1984-86	1500 4WD Shortbed (2 Pc.)		
DDV1002	1987	1500 4WD Longbed (2 Pc.) Ram		
DDV1003	1989	Ram 4WD 131" WB		
DDV1006	1989	1500 2WD Longbed - Union to engine		
DDV1005	1990	D150 2WD 318 CID Longbed - Fuel Injected		
DDV1012	1990	Dakota 2WD Standard Cab Shortbed Rear ABS		
DDV1008	1991	Ramcharger		
DDV1004	1993	Dakota 2WD		
DDV1015	1994	2500 4WD Standard Cab Longbed 360 CID		
DDV1013	1996	2500 4WD Regular Cab Longbed V8 Gas Motor		
DDV1017	1996-97	1500 4WD Extended Cab Shortbed		
DDV1010	1997	1500 & 2500 4WD Extended Cab Longbed 360 CID Gas (1 Pc.)		
DDV1016	2000-01	2500 4WD Quad Cab Longbed		



Transmission Lines (Sold In Pairs)			Dodge Truck	
Part No.	Year	Description	O.E. Steel	Stainless Steel
DDT1001	1979	Ramcharger		
DDT1002	1979	Little Red Express 727 2WD V8		
DDT1003	1982	W150 4WD 727 Transmission Without Aux Cooler		
DDT1004	1982	W150 4WD 727 Transmission With Aux Cooler		
DDT1008	1996-97	3500 4WD Diesel		
DDT1008	1996-97	2500 4WD Diesel		
DDT1007	1998	3500 4WD Diesel		
DDT1007	1998	2500 4WD Diesel		
DDT1005	1999	2500 & 3500 4WD Diesel Regular Cab Longbed		
DDT1006	1999	1500 318 CID V8 A518 OD Transmission Plow Package		

Miscellaneous & Other Lines			Dodge Truck	
Part No.	Year	Description	O.E. Steel	Stainless Steel
DDS1001	1981-86	1500 V8 - Single Tank - Standpipe Line Set (3 Pc.)		
DDO1002	1996	2500 4WD Vacuum Line - Transfer Case To Front Axle Controls		

# PLYMOUTH

## PLYMOUTH EARLY & MISC.

### Complete Brake Line Kit Plymouth Early & Misc.

Part No.	Year	Description	O.E. Steel	Stainless Steel
PY1001	1933	All Models		
PY1011	1946-49	Series P-15		
PY1010	1950	Business Man Coupe Deluxe		
PY1009	1957-59	Fury Power Brake		
PY1002	1957-59	Fury Standard Brake		
PY1013	1962-64	Fury w/ 8-3/4" Axle		
PY1013	1962-64	Belvedere w/ 8-3/4" Axle		
PY1004	1965-66	Sport Fury Standard Brake		
PY1012	1965-66	Sport Fury Power Drum		
PY1014	1967-68	Sport Fury		
PY1006	1967-68	Sport Fury Standard Brake		
BB1053	1970	Super Bird Standard Drum Brake - Right Front Line Routes Under Frame - 8-3/4" and Dana Axle		
BB1057	1970	Super Bird Standard Disc Brake - Right Front Line Routes Under Frame - 8-3/4" and Dana Axle		
BB1061	1970	Super Bird Standard Disc Brake - Right Front Line Routes Over Frame - 8-3/4" and Dana Axle		
BB1065	1970	Super Bird Standard Drum Brake - Right Front Line Routes Over Frame - 8-3/4" and Dana Axle		
BB1069	1970	Super Bird Power Drum Brake & Hemi - Right Front Line Routes Under Frame - 8-3/4" and Dana Axle		
BB1073	1970	Super Bird Power Disc Brake & Hemi - Right Front Line Routes Under Frame - 8-3/4" and Dana Axle		
BB1077	1970	Super Bird Power Drum Brake & Hemi - Right Front Line Routes Over Frame - 8-3/4" and Dana Axle		
BB1081	1970	Super Bird Power Disc Brake & Hemi - Right Front Line Routes Over Frame - 8-3/4" and Dana Axle		
BB1093	1970	Super Bird Power Disc - Right Front Routes Under Frame - Right Ported Master Cylinder - 8-3/4" and Dana Axle - Without Metering Valve (2 Pc. Front to Rear)		
BB1097	1970	Super Bird Power Disc - Right Front Line Routes Over Frame - Master Cylinder Right Ported - 8-3/4" and Dana Axle		
BB1147	1970	Super Bird Standard Disc - Right Front Routes Over Frame - 8-3/4" and Dana Axle - With Metering Valve (1 Pc. Front to Rear)		
BB1149	1970	Super Bird Standard Disc - Right Front Routes Under Frame - 8-3/4" and Dana Axle - With Metering Valve (1 Pc. Front to Rear)		
BB1151	1970	Super Bird Power Disc - Right Front Routes Over Frame - Left Ported Master Cylinder - 8-3/4" and Dana Axle - With Metering Valve (2 Pc. Front to Rear)		

BB1153	1970	Super Bird Power Disc - Right Front Routes Over Frame - Right Ported Master Cylinder - 8-3/4" and Dana Axle - With Metering Valve (2 Pc. Front to Rear)
BB1155	1970	Super Bird Power Disc - Right Front Routes Under Frame - Left Ported Master Cylinder - 8-3/4" and Dana Axle - With Metering Valve (2 Pc. Front to Rear)
AB1023	1970	Duster Standard Disc - 108" Wheelbase 7-1/4" Axle (2 Pc. Front to Rear)
AB1024	1970	Duster Standard Disc - 108" Wheelbase (2 Pc. Front to Rear) 8-3/4" Axle
AB1035	1970	Duster Standard Disc - 111" Wheelbase 8-3/4" Axle (2 Pc. Front to Rear)
AB1037	1970	Duster Power Disc - 108" Wheelbase 7-1/4" Axle 2 (Pc.) Front to rear
AB1060	1970	Duster Standard Drum - 108" Wheelbase 8-3/4" Axle (1 Pc. Front to Rear)
AB1062	1970	Duster Power Drum - 108" Wheelbase 8-3/4" Axle (1 Pc. Front to Rear)
AB1064	1970	Duster Power Disc - 108" Wheelbase 8-3/4" Axle (2 Pc. Front to Rear)
AB1035	1970-72	Duster Power Brakes - 108" WB - 7-1/4" Axle
AB1036	1971	Duster Power Drum - 108" Wheelbase 8-3/4" Axle
AB1065	1971	Duster Standard Brake - 108" Wheelbase 8-3/4" Axle
AB1098	1971	Duster Standard Brake - 108" Wheelbase 7-1/4" Axle
AB1100	1971	Duster Power Brake - 108" Wheelbase 7-1/4" Axle
AB1029	1972	Duster Standard Brake - 108" Wheelbase 8-3/4" Axle
AB1043	1972	Duster Power Drum - 108" Wheelbase 8-3/4" Axle
AB1043	1972	Scamp Power Drum - 108" Wheelbase 8-3/4" Axle
AB1075	1972	Duster Power Drum - 108" Wheelbase 7-1/4" Axle
AB1075	1972	Scamp Power Drum - 108" Wheelbase 7-1/4" Axle
AB1077	1972	Duster Standard Disc - 108" Wheelbase 7-1/4" Axle
AB1077	1972	Scamp Standard Disc - 108" Wheelbase 7-1/4" Axle
BB1122	1973	Sebring Power Disc - 8-3/4" and Dana Axle
AB1030	1973-74	Duster Standard Drum - 108" Wheelbase 7-1/4" Axle
AB1030	1973-74	Scamp Standard Drum - 108" Wheelbase 7-1/4" Axle
AB1072	1973-74	Duster Standard Drum - 108" Wheelbase 8-3/4" Axle
AB1072	1973-74	Scamp Standard Drum - 108" Wheelbase 8-3/4" Axle
BB1122	1973-74	Sebring Power Disc 8-3/4 Axle
AB1029	1973-76	Duster Standard Brakes - 108" WB - 8-3/4" Axle
AB1044	1975-76	Duster Power Drum - 108" Wheelbase 7-1/4" Axle
AB1044	1975-76	Scamp Power Drum - 108" Wheelbase 7-1/4" Axle
AB1090	1975-76	Duster Power Disc - 108" Wheelbase 7-1/4" Axle
AB1090	1975-76	Scamp Power Disc - 108" Wheelbase 7-1/4" Axle
AB1092	1975-76	Duster Standard Disc - 108" Wheelbase 7-1/4" Axle
AB1092	1975-76	Scamp Standard Disc - 108" Wheelbase 7-1/4" Axle
AB1030	1976	Duster Standard Brakes - 108" WB - 7-1/4" Axle
AB1044	1976	Duster Power Brakes - 108" WB - 7-1/4" Axle
PY1015	1995-99	Neon

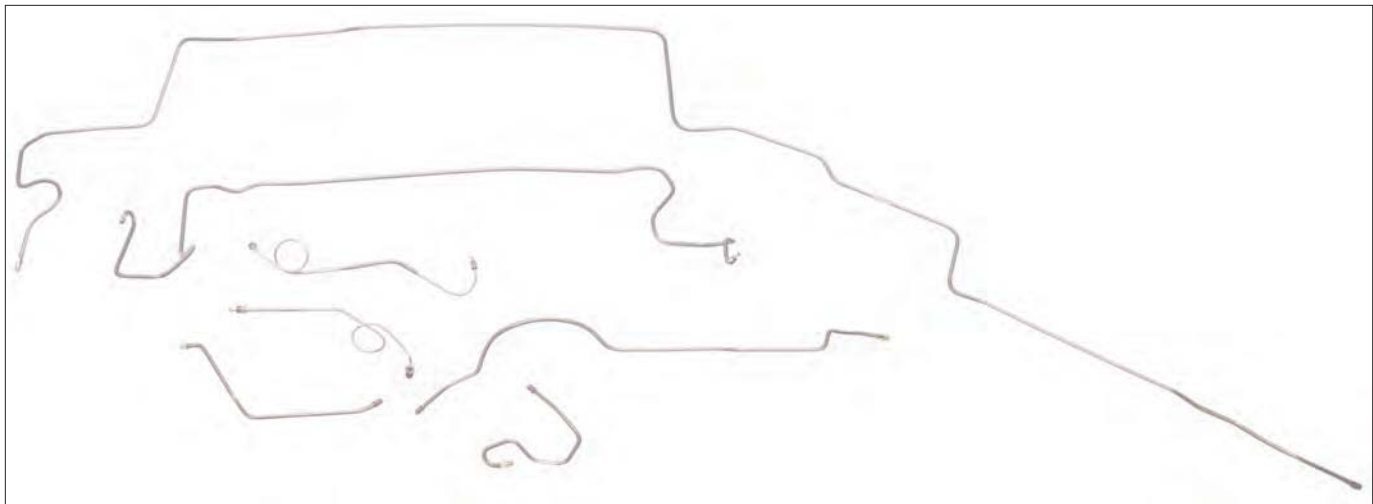

# PLYMOUTH

Wheel Cylinder Lines (Sold in Pairs)			Plymouth Early & Misc.	
Part No.	Year	Description	O.E. Steel	Stainless Steel
CYD1001	1960	Fury Dual System		

Fuel - Pump To Carburetor Line			Plymouth Early & Misc.	
Part No.	Year	Description	O.E. Steel	Stainless Steel
PYC1001	1966	Fury I 6 Cylinder (2 Pc.)		
PYC1003	1966	Fury III		
PYC1004	1974-75	Grand Fury 440 CID Carter Thermoquad Carburetor (2 Pc.)		

Fuel - Tank To Pump Line			Plymouth Early & Misc.	
Part No.	Year	Description	O.E. Steel	Stainless Steel
PYF1001	1933			
PYF1006	1956-58	Sport Fury		
PYF1006	1958	Fury		
PYF1002	1959			
PYF1008	1960	Fury (2 Pc.)		
PYF1003	1965	Sport Fury 5/16" (2 Pc.)		
PYF1004	1966	Fury III		
PYF1005	1968	Fury III (2 Pc.)		
BBF1011	1970	Super Bird Small Block - 5/16"		
BBF1012	1970	Super Bird Big Block & Hemi - 3/8"		
ABF1005	1970-72	Duster 108" WB 5/16"		
ABF1006	1970-72	Duster 108" WB 3/8"		
ABF1006	1971-72	Scamp 108" WB 3/8"		
ABF1009	1973-76	Duster 108" WB 5/16"		
ABF1010	1973-76	Duster 108" WB 3/8"		

Fuel - Return Line			Plymouth Early & Misc.	
Part No.	Year	Description	O.E. Steel	Stainless Steel
BBR1004	1970	Super Bird 1/4"		
ABR1001	1973-76	Duster 108" WB (2 Pc.)		

Fuel - Vapor Line			Plymouth Early & Misc.	
Part No.	Year	Description	O.E. Steel	Stainless Steel
BBV1001	1970	Super Bird 5/16" (2 Pc.)		
ABV1001	1971-72	Duster 108" WB		

Transmission Lines (Sold In Pairs)			Plymouth Early & Misc.	
Part No.	Year	Description	O.E. Steel	Stainless Steel
CYT1015	1959	Station Wagon		
BBT1007	1964-65	Fury A727 Transmission		
CYT1003	1966	Sport Fury III Small Block		
CYT1005	1966	Fury I 6 Cylinder		
BBT1003	1966-70	Super Bird Small Block		
BBT1004	1969-70	Super Bird Big Block - with Oil Filter at Radiator - Drivers Side		
CBT1001	1969-73	Fury 360 CID 904 Transmission		
BBT1011	1970	Super Bird Hemi - with Aux Cooler (4 Pc.)		
ABT1004	1973	Duster V8 A727 Transmission		
ABT1007	1974	Duster 360 CID - 727 Torque Flite		
PYT1001	1974-75	Grand Fury 440 CID A727 Transmission		

Miscellaneous & Other Lines			Plymouth Early & Misc.	
Part No.	Year	Description	O.E. Steel	Stainless Steel
PY01001	1991	Laser Steering Rack and Pinion Lines		

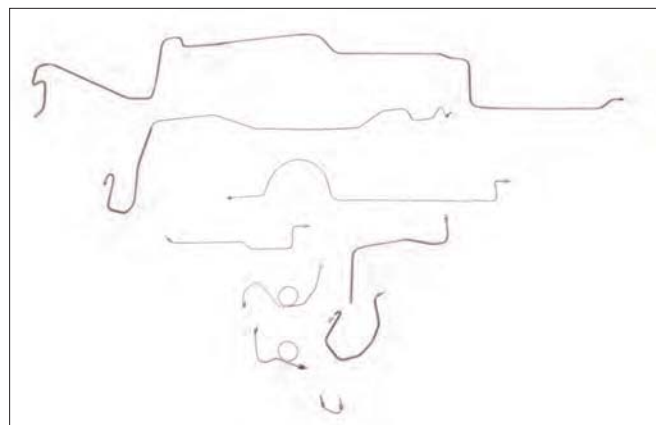

## BARRACUDA

Complete Brake Line Kit			Barracuda	
Part No.	Year	Description	O.E. Steel	Stainless Steel
AB1049	1964-66	Drum - 106" WB		
AB1094	1964-66	Standard Drum - 106" Wheelbase 7-1/4" Axle		
AB1095	1964-66	Power Drum - 106" Wheelbase 7-1/4" Axle		
AB1049	1966	Standard Drum - 106" Wheelbase 8-3/4" Axle		
AB1001	1967	Standard Drum - 108" WB - 7-1/4" Axle		
AB1002	1967	Standard Drum - 108" WB - 8-3/4" Axle		
AB1003	1967	Standard Disc - 108" WB - Proportioning Valve on Frame (2 Pc.) - 7-1/4" Axle		
AB1004	1967	Standard Disc - 108" WB - Proportioning Valve on Frame (2 Pc.) - 8-3/4" Axle		
AB1011	1967	Power Drum - 108" WB - 7-1/4" Axle		
AB1012	1967	Power Drum - 108" WB - 8-3/4" Axle		
AB1013	1967	Power Disc - 108" WB - Proportioning Valve on Frame (2 Pc.) - 7-1/4" Axle		
AB1014	1967	Power Disc - 108" WB - Proportioning Valve on Frame (2 Pc.) - 8-3/4" Axle		
AB1021	1968-69	Standard Brakes - 108" WB - 7-1/4" Axle		
AB1022	1968-69	Standard Brakes - 108" WB - 8-3/4" Axle		
AB1053	1968-69	Power Drum - 108" Wheelbase 8-3/4" Axle (1 Pc. Front to Rear)		
AB1057	1968-69	Standard Disc - 108" Wheelbase (2 Pc. Front to Rear) 8-3/4" Axle		
AB1059	1968-69	Power Disc - 108" Wheelbase 8-3/4" Axle (2 Pc. Front to Rear)		
EB1002	1970-71	Standard Drum - RF Line: Routes Under Frame - 8-3/4" and Dana Axle		
EB1006	1970-71	Power Drum - RF Line: Routes Under Frame - 8-3/4" and Dana Axle		
EB1010	1970-71	Standard Disc - RF Line: Routes Under Frame - 8-3/4" and Dana Axle		
EB1014	1970-71	Power Disc - RF Line: Routes Under Frame - 8-3/4" and Dana Axle		
EB1018	1970-71	Hemi & 6 Pack Big Block - Power Disc - RF Line: Routes Under Frame (5 Pc.) - 8-3/4" and Dana Axle		
EB1038	1970-71	Standard Drum - RF Line: Routes Over Frame - 8-3/4" and Dana Axle		
EB1042	1970-71	Power Drum - RF Line: Routes Over Frame - 8-3/4" and Dana Axle		
EB1046	1970-71	Standard Disc - RF Line: Routes Over Frame - 8-3/4" and Dana Axle		
EB1050	1970-71	Power Disc - RF Line: Routes Over Frame - 8-3/4" and Dana Axle		
EB1054	1970-71	Hemi & 6 Pack Big Block - Power Disc - RF Line: Routes Over Frame (5 Pc.) - 8-3/4" and Dana Axle		
EB1074	1970-71	Standard Disc - Right Front Routes Under Frame - 8-3/4" and Dana Axle - With Metering Valve (1 Pc. Front to Rear)		
EB1075	1970-71	Standard Disc - Right Front Routes Under Frame - 8-3/4" and Dana Axle - With Metering Valve (2 Pc. Front to Rear)		
EB1078	1970-71	Standard Disc - Right Front Routes Over Frame - 8-3/4" and Dana Axle - With Metering Valve (1 Pc. Front to Rear)		
EB1079	1970-71	Standard Disc - Right Front Routes Over Frame - 8-3/4" and Dana Axle - With Metering Valve (2 Pc. Front to Rear)		
EB1082	1970-71	Power Disc - Right Front Routes Under Frame - 8-3/4" and Dana Axle - With Metering Valve (2 Pc. Front to Rear)		

# PLYMOUTH

Cont. from previous page

EB1083	1970-71	Power Disc - Right Front Routes Over Frame - 8-3/4" and Dana Axle with Metering Valve - 2 Pc. Front to Rear
EB1022	1972-74	Standard Drum - RF Line: Routes Under Frame - 8-3/4" and Dana Axle
EB1026	1972-74	Power Drum - RF Line: Routes Under Frame - 8-3/4" and Dana Axle
EB1030	1972-74	Standard Disc - RF Line: Routes Under Frame - 8-3/4" and Dana Axle
EB1034	1972-74	Power Disc - RF Line: Routes Under Frame - 8-3/4" and Dana Axle
EB1058	1972-74	Standard Drum - RF Line: Routes Over Frame - 8-3/4" and Dana Axle
EB1062	1972-74	Power Drum - RF Line: Routes Over Frame - 8-3/4" and Dana Axle
EB1066	1972-74	Standard Disc - RF Line: Routes Over Frame - 8-3/4" and Dana Axle
EB1070	1972-74	Power Disc - RF Line: Routes Over Frame - 8-3/4" and Dana Axle

Fuel - Tank To Pump Line			Barracuda
Part No.	Year	Description	O.E. Steel Stainless Steel
BAF1003	1964-66	106" Wheelbase	
ABF1001	1967-68	108" WB 5/16"	
ABF1002	1967-68	108" WB 3/8"	
ABF1005	1969	108" WB 5/16"	
ABF1006	1969	108" WB 3/8"	
BAF1001	1970-74	Small Block and 383 CID - 5/16"	
BAF1002	1970-74	426 CID and 440 CID - 3/8"	

Fuel - Return Line			Barracuda
Part No.	Year	Description	O.E. Steel Stainless Steel
BAR1001	1970-74	1/4"	

Fuel - Vapor Line			Barracuda
Part No.	Year	Description	O.E. Steel Stainless Steel
BAV1001	1970-74	5/16" (2 Pc.)	

Fuel - Vent Line			Barracuda
Part No.	Year	Description	O.E. Steel Stainless Steel
EBO1001	1970	With Hemi (2 Pc.)	

Transmission Lines (Sold In Pairs)			Barracuda
Part No.	Year	Description	O.E. Steel Stainless Steel
ABT1003	1967-69	V8 - 904 Transmission	
BBT1010	1970	Small Block - A727 Transmission	
BBT1005	1971-74	Small Block - 904 Transmission	
BBT1006	1971-74	Big Block - 727 Transmission	
BBT1010	1970	Small Block - A727 Transmission	
BBT1013	1972-74	Hemi - 727 with Aux Cooler (4 Pc.)	

## BELVEDERE

Complete Brake Line Kit			Belvedere
Part No.	Year	Description	O.E. Steel Stainless Steel
BB1175	1964	Standard Brake	
BB1002	1964-65	Power Brake	
BB1001	1965	Standard Brake	
BB1003	1966	Standard Brake - Right Line Straight at Center - Drum - 7-1/4" Axle	
BB1004	1966	Standard Brake - Right Front Line Straight at Center - Drum - 8-3/4" Axle	
BB1005	1966	Standard Brake - Right Front Line Straight at Center - Dana Axle	
BB1009	1966	Standard Brake - Right Front Line 4" Rise at Center - Drum - 7-1/4" Axle	
BB1010	1966	Standard Brake - Right Front Line 4" Rise at Center - Drum - 8-3/4" Axle	
BB1011	1966	Standard Brake - Right Front Line 4" Rise at Center - Dana Axle	
BB1015	1966	Power Brake - Right Front Line Straight at Center - Drum - 7-1/4" Axle	
BB1016	1966	Power Brake & Hemi - Right Front Line Straight at Center - Drum - 8-3/4" Axle	
BB1017	1966	Power Brake & Hemi - Right Front Line Straight at Center - Dana Axle	
BB1020	1966	Power Brake - Right Front Line 4" Rise at Center - Drum - 7-1/4" Axle	
BB1021	1966	Power Brake & Hemi - Right Front Line 4" Rise at Center - Dana Axle	
BB1022	1966	Power Brake & Hemi - Right Front Line 4" Rise at Center - Dana Axle	
BB1026	1967	Standard Drum Brake - Right Front Line Straight at Center - 7-1/4" Axle	
BB1027	1967	Standard Drum Brake - Right Front Line Straight at Center - 8-3/4" Axle	
BB1028	1967	Standard Drum Brake - Right Front Line Straight at Center - Dana Axle	
BB1029	1967	Standard Disc Brake - Right Front Line Straight at Center - 7-1/4" Axle	
BB1030	1967	Standard Disc Brake - Right Front Line Straight at Center - 8-3/4" Axle	
BB1031	1967	Standard Disc Brake - Right Front Line Straight at Center - Dana Axle	
BB1032	1967	Standard Drum Brake - Right Front Line 4" Rise at Center - 7-1/4" Axle	
BB1033	1967	Standard Drum Brake - Right Front Line 4" Rise at Center - 8-3/4" Axle	
BB1034	1967	Standard Drum Brake - Right Front Line 4" Rise at Center - Dana Axle	
BB1035	1967	Standard Disc Brake - Right Front Line 4" Rise at Center - 7-1/4" Axle	
BB1036	1967	Standard Disc Brake - Right Front Line 4" Rise at Center - 8-3/4" Axle	
BB1037	1967	Standard Disc Brake - Right Front Line 4" Rise at Center - Dana Axle	
BB1038	1967	Power Drum Brake - Right Front Line Straight at Center - 7-1/4" Axle	

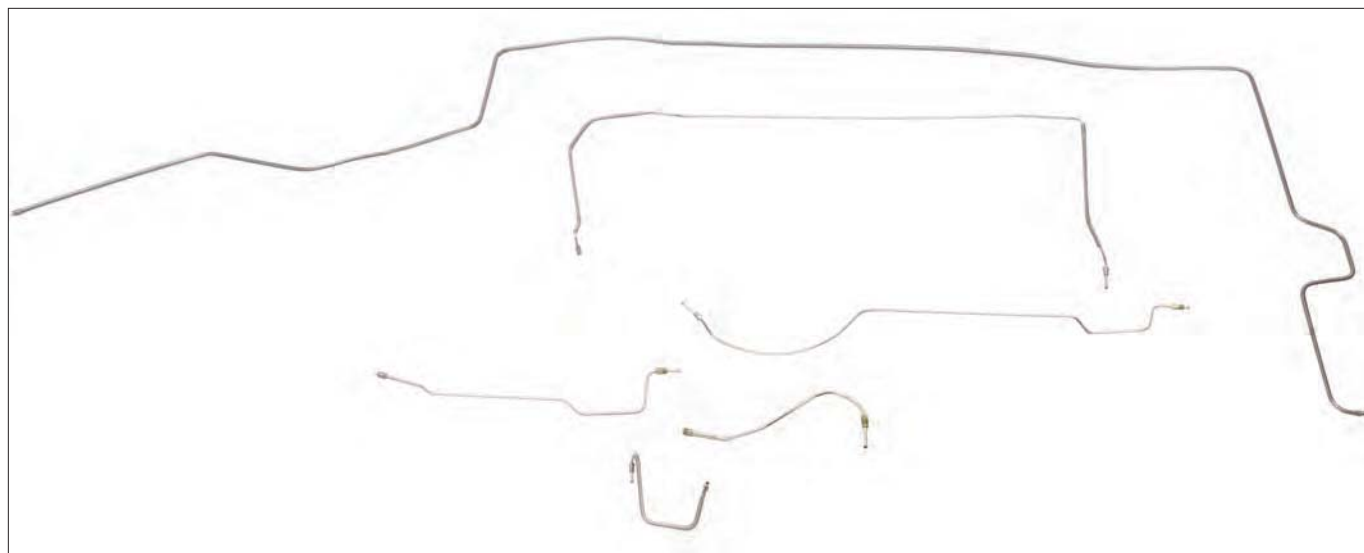

# PLYMOUTH

BB1039	1967	Power Drum Brake - Right Front Line Straight at Center - 8-3/4" Axle
BB1040	1967	Power Drum Brake - Right Front Line Straight at Center - Dana Axle
BB1041	1967	Power Disc Brake - Right Front Line Straight at Center - 7-1/4" Axle
BB1042	1967	Power Disc Brake - Right Front Line Straight at Center - 8-3/4" Axle
BB1043	1967	Power Disc Brake - Right Front Line Straight at Center - Dana Axle
BB1044	1967	Power Drum Brake - Right Front Line 4" Rise at Center - 7-1/4" Axle
BB1045	1967	Power Drum Brake - Right Front Line 4" Rise at Center - 8-3/4" Axle
BB1046	1967	Power Drum Brake - Right Front Line 4" Rise at Center - Dana Axle
BB1047	1967	Power Disc Brake - Right Front Line 4" Rise at Center - 7-1/4" Axle
BB1048	1967	Power Disc Brake - Right Front Line 4" Rise at Center - 8-3/4" Axle
BB1049	1967	Power Disc Brake - Right Front Line 4" Rise at Center - Dana Axle
BB1050	1968-69	Standard Drum Brake - Right Front Line Routes Under Frame - 7-1/4" Axle
BB1051	1968-69	Standard Drum Brake - Right Front Line Routes Under Frame - 8-3/4" Axle
BB1052	1968-69	Standard Drum Brake - Right Front Line Routes Under Frame - Dana Axle
BB1054	1968-69	Standard Disc Brake - Right Front Line Routes Under Frame - 7-1/4" Axle
BB1055	1968-69	Standard Disc Brake - Right Front Line Routes Under Frame - 8-3/4" Axle
BB1056	1968-69	Standard Disc Brake - Right Front Line Routes Under Frame - Dana Axle
BB1058	1968-69	Standard Drum Brake - Right Front Line Routes Over Frame - 7-1/4" Axle
BB1059	1968-69	Standard Drum Brake - Right Front Line Routes Over Frame - 8-3/4" Axle
BB1060	1968-69	Standard Drum Brake - Right Front Line Routes Over Frame - Dana Axle
BB1062	1968-69	Standard Disc Brake - Right Front Line Routes Over Frame - 7-1/4" Axle
BB1063	1968-69	Standard Disc Brake - Right Front Line Routes Over Frame - 8-3/4" Axle
BB1064	1968-69	Standard Disc Brake - Right Front Line Routes Over Frame - Dana Axle
BB1066	1968-69	Power Drum - Right Front Routes Under Frame - 7-1/4" Axle (1 Pc. Front to Rear)
BB1067	1968-69	Power Drum Brake & Hemi - Right Front Line Routes Under Frame - 8-3/4" Axle
BB1068	1968-69	Power Drum - Right Front Routes Under Frame - Dana Axle (1 Pc. Front to Rear)
BB1070	1968-69	Power Disc - Right Front Routes Under Frame - Left Ported Master Cylinder - 7-1/4" Axle (2 Pc. Front to Rear) (1969 - Without Metering Valve)
BB1071	1968-69	Power Disc - Right Front Routes Under Frame - Left Ported Master Cylinder - 8-3/4" Axle (2 Pc. Front to Rear) (1969 - Without Metering Valve)
BB1072	1968-69	Power Disc - Right Front Routes Under Frame - Left Ported Master Cylinder - Dana Axle (2 Pc. Front to Rear) (1969 - Without Metering Valve)
BB1074	1968-69	Power Drum - Right Front Routes Over Frame - 7-1/4" Axle (1 Pc. Front to Rear)
BB1075	1968-69	Power Drum - Right Front Routes Over Frame - 8-3/4" Axle (1 Pc. Front to Rear)
BB1076	1968-69	Power Drum - Right Front Line Routes Over Frame - Dana Axle (1 Pc. Front to Rear)
BB1078	1968-69	Power Disc Brake - Right Front Line Routes Over Frame - 7-1/4" Axle
BB1079	1968-69	Power Disc Brake & Hemi - Right Front Line Routes Over Frame - 8-3/4" Axle
BB1080	1968-69	Power Disc - Right Front Routes Over Frame - Dana Axle - Left Ported Master Cylinder (2 Pc. Front to Rear) (1969 - Without Metering Valve)
BB1090	1968-69	Power Disc - Right Front Routes Under Frame - Right Ported Master Cylinder - 7-1/4" Axle (2 Pc. Front to Rear) (1969 - Without Metering Valve)
BB1091	1968-69	Power Disc - Right Front Routes Under Frame - Right Ported Master Cylinder - 8-3/4" Axle (2 Pc. Front to Rear) (1969 - Without Metering Valve)
BB1092	1968-69	Power Disc - Right Front Routes Under Frame - Right Ported Master Cylinder - Dana Axle (2 Pc. Front to Rear) (1969 - Without Metering Valve)

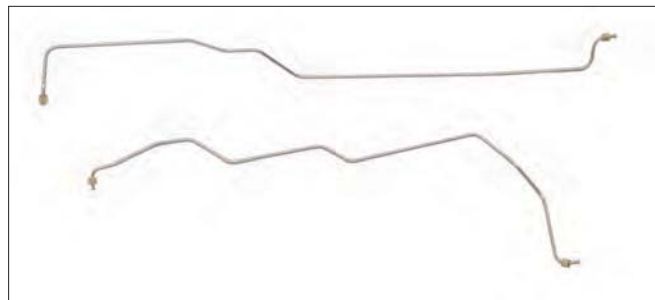

BB1094	1968-69	Power Disc - Right Front Routes Over Frame - Right Ported Master Cylinder - 7-1/4" Axle (2 Pc. Front to Rear) (1969 - Without Metering Valve)
BB1095	1968-69	Power Disc - Right Front Routes Over Frame - Right Ported Master Cylinder - 8-3/4" Axle (2 Pc. Front to Rear) (1969 - Without Metering Valve)
BB1096	1968-69	Power Disc - Right Front Routes Over Frame - Right Ported Master Cylinder - Dana Axle (2 Pc. Front to Rear) (1969 - Without Metering Valve)
BB1067	1969	Power Drum - Right Front Routes Under Frame - 8-3/4" Axle (1 Pc. Front to Rear)
BB1079	1969	Power Disc - Right Front Routes Over Frame - 8-3/4" Axle - Left Ported Master Cylinder (2 Pc. Front to Rear) (1969 - Without Metering Valve)
BB1129	1969	Standard Disc - Right Front Routes Over Frame - 8-3/4" Axle - With Metering Valve (1 Pc. Front to Rear)
BB1130	1969	Standard Disc - Right Front Routes Over Frame - 7-1/4" Axle - With Metering Valve (1 Pc. Front to Rear)
BB1131	1969	Standard Disc - Right Front Routes Under Frame - 8-3/4" Axle - With Metering Valve (1 Pc. Front to Rear)
BB1132	1969	Standard Disc - Right Front Routes Under Frame - 7-1/4" Axle - With Metering Valve (1 Pc. Front to Rear)
BB1133	1969	Power Disc - Right Front Routes Over Frame - 8-3/4" Axle - Left Ported Master Cylinder - With Metering Valve (2 Pc. Front to Rear)
BB1134	1969	Power Disc - Right Front Routes Over Frame - 7-1/4" Axle - Left Ported Master Cylinder - With Metering Valve (2 Pc. Front to Rear)
BB1135	1969	Power Disc - Right Front Routes Over Frame - 8-3/4" Axle - Right Ported Master Cylinder - With Metering Valve (2 Pc. Front to Rear)
BB1136	1969	Power Disc - Right Front Routes Over Frame - 7-1/4" Axle - Right Ported Master Cylinder - With Metering Valve (2 Pc. Front to Rear)
BB1137	1969	Power Disc - Right Front Routes Under Frame - 8-3/4" Axle - Left Ported Master Cylinder - With Metering Valve (2 Pc. Front to Rear)
BB1138	1969	Power Disc - Right Front Routes Under Frame - 7-1/4" Axle - Left Ported Master Cylinder - With Metering Valve (2 Pc. Front to Rear)
BB1139	1969	Power Disc - Right Front Routes Under Frame - 8-3/4" Axle - Right Ported Master Cylinder - With Metering Valve (2 Pc. Front to Rear)
BB1140	1969	Power Disc - Right Front Routes Under Frame - 7-1/4" Axle - Right Ported Master Cylinder - With Metering Valve (2 Pc. Front to Rear)
BB1169	1969	Standard Disc - Right Front Routes Over Frame - Dana Axle - With Metering Valve (1 Pc. Front to Rear)
BB1170	1969	Standard Disc - Right Front Routes Under Frame - Dana Axle - With Metering Valve (1 Pc. Front to Rear)
BB1171	1969	Power Disc - Right Front Routes Over Frame - Left Ported Master Cylinder - Dana Axle - With Metering Valve (2 Pc. Front to Rear)
BB1172	1969	Power Disc - Right Front Routes Over Frame - Right Ported Master Cylinder - Dana - With Metering Valve (2 Pc. Front to Rear)
BB1173	1969	Power Disc - Right Front Routes Under Frame - Left Ported Master Cylinder - Dana Axle - With Metering Valve (2 Pc. Front to Rear)
BB1174	1969	Power Disc - Right Front Routes Under Frame - Right Ported Master Cylinder - Dana Axle - With Metering Valve (2 Pc. Front to Rear)
BB1053	1970	Standard Drum - Right Front Routes Under Frame - 8-3/4" and Dana Axle (1 Pc. Front to Rear)
BB1057	1970	Standard Disc Brake - Right Front Line Routes Under Frame - 8-3/4" and Dana Axle
BB1061	1970	Standard Disc - Right Front Routes Over Frame - 8-3/4" and Dana Axle - Without Metering Valve (2 Pc. Front to Rear)
BB1065	1970	Standard Drum - Right Front Routes Over Frame - 8-3/4" and Dana Axle (1 Pc. Front to Rear)

# PLYMOUTH

Cont. from previous page

BB1073	1970	Power Disc Brake & Hemi - Right Front Line Routes Under Frame - 8-3/4" and Dana Axle
BB1077	1970	Power Drum Brake & Hemi - Right Front Line Routes Over Frame - 8-3/4" and Dana Axle
BB1081	1970	Power Disc Brake & Hemi - Right Front Line Routes Over Frame - 8-3/4" and Dana Axle
BB1085	1970	Standard Disc - Right Front Line Routes Under Frame - Master Cylinder Left Ported - 8-3/4" and Dana Axle
BB1089	1970	Standard Disc - Right Front Line Routes Under Frame - Master Cylinder Right Ported - 8-3/4" and Dana Axle
BB1093	1970	Power Disc - Right Front Line Routes Under Frame - Master Cylinder Right Ported - 8-3/4" and Dana Axle
BB1097	1970	Power Disc - Right Front Line Routes Over Frame - Master Cylinder Right Ported - 8-3/4" and Dana Axle
BB1102	1970	Power Disc & Hemi - Right Front Line Routes Under Frame - Master Cylinder Left Ported - 8-3/4" and Dana Axle
BB1106	1970	Power Disc & Hemi - Right Front Line Routes Over Frame - Master Cylinder Left Ported - 8-3/4" and Dana Axle
BB1143	1970	Power Disc - Right Front Line straight at Center - Dana Axle
BB1144	1970	Power Disc - Right Front Line 4" Rise at Center - 7-1/4" Axle
BB1147	1970	Standard Disc - Right Front Routes Over Frame - 8-3/4" and Dana Axle - With Metering Valve (1 Pc. Front to Rear)
BB1148	1970	Power Disc - Right Front Line 4" Rise at Center - 8-3/4" Axle
BB1149	1970	Standard Disc - Right Front Routes Under Frame - 8-3/4" and Dana Axle - With Metering Valve (1 Pc. Front to Rear)
BB1151	1970	Power Disc - Right Front Routes Over Frame - Left Ported Master Cylinder - 8-3/4" and Dana Axle - With Metering Valve (2 Pc. Front to Rear)
BB1152	1970	Power Disc - Right Front Routes Under Frame - Left Ported Master Cylinder - 7-1/4" Axle W/ Metering Valve
BB1153	1970	Power Disc - Right Front Routes Over Frame - Right Ported Master Cylinder - 8-3/4" and Dana Axle - W/ Metering Valve (2 Pc. Front to Rear)
BB1155	1970	Power Disc - Right Front Routes Under Frame - Left Ported Master Cylinder - 8-3/4" and Dana Axle - With Metering Valve (2 Pc. Front to Rear)
BB1157	1970	Power Disc - Right Front Routes Under Frame - Right Ported Master Cylinder - 8-3/4" and Dana Axle - With Metering Valve (2 Pc. Front to Rear)
BB1158	1970	Standard Drum - Right Front Routes Over Frame 7-1/4" Axle
EB1078	1970-71	Standard Disc - Right Front Routes Over Frame - 8-3/4" and Dana Axle - With Metering Valve (1 Pc. Front to Rear)
EB1081	1970-71	Power Disc - Right Front Routes Under Frame - 8-3/4" and Dana - With Metering Valve (2 Pc. Front to Rear)

Fuel - Tank To Pump Line			Belvedere
Part No.	Year	Description	O.E. Steel Stainless Steel
PYF1006	1956-58		
BBF1001	1964-65	Small Block - 5/16"	
BBF1002	1965	Big Block and Hemi - 3/8"	
BBF1004	1966-67	Big Block & Hemi - 3/8"	
BBF1003	1967	Small Block - 5/16"	
BBF1005	1968-69	Small Block - 5/16"	
BBF1006	1968-69	Big Block & Hemi - 3/8"	
BBF1011	1970	Small Block - 5/16"	
BBF1012	1970	Big Block & Hemi - 3/8"	

Fuel - Return Line			Belvedere
Part No.	Year	Description	O.E. Steel Stainless Steel
BBR1002	1968-69	Big Block and Hemi - 1/4"	
BBR1004	1970	1/4"	

Fuel - Vapor Line			Belvedere
Part No.	Year	Description	O.E. Steel Stainless Steel
BBV1001	1970	5/16" (2 Pc.)	

Transmission Lines (Sold In Pairs)			Belvedere
Part No.	Year	Description	O.E. Steel Stainless Steel
BBT1007	1965	318 CID	
BBT1001	1966-68	Big Block	
BBT1003	1966-70	Small Block	
BBT1002	1969	Transmission to Radiator - Radiator to Aux Cooler (4 Pc.)	
BBT1004	1969-70	Big Block - with Oil Filter at Radiator - Drivers Side	
BBT1011	1970	Hemi - with Aux Cooler (4 Pc.)	
BBT1015	1971	Small Block - with 727 Transmission	

## GTX

Complete Brake Line Kit			GTX
Part No.	Year	Description	O.E. Steel Stainless Steel
BB1026	1967	Standard Drum Brake - Right Front Line Straight at Center - 7-1/4" Axle	
BB1027	1967	Standard Drum Brake - Right Front Line Straight at Center - 8-3/4" Axle	
BB1028	1967	Standard Drum Brake - Right Front Line Straight at Center - Dana Axle	

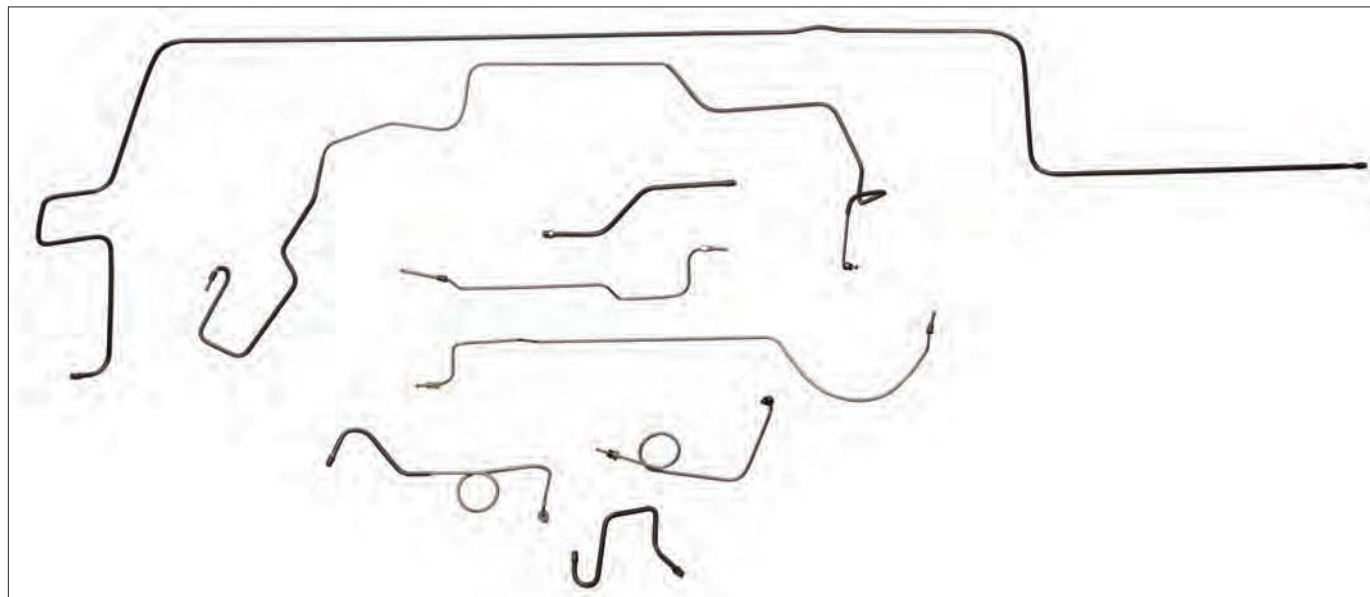

# PLYMOUTH

BB1029	1967	Standard Disc Brake - Right Front Line Straight at Center - 7-1/4" Axle
BB1030	1967	Standard Disc Brake - Right Front Line Straight at Center - 8-3/4" Axle
BB1031	1967	Standard Disc Brake - Right Front Line Straight at Center - Dana Axle
BB1032	1967	Standard Drum Brake - Right Front Line 4" Rise at Center - 7-1/4" Axle
BB1033	1967	Standard Drum Brake - Right Front Line 4" Rise at Center - 8-3/4" Axle
BB1034	1967	Standard Drum Brake - Right Front Line 4" Rise at Center - Dana Axle
BB1035	1967	Standard Disc Brake - Right Front Line 4" Rise at Center - 7-1/4" Axle
BB1036	1967	Standard Disc Brake - Right Front Line 4" Rise at Center - 8-3/4" Axle
BB1037	1967	Standard Disc Brake - Right Front Line 4" Rise at Center - Dana Axle
BB1038	1967	Power Drum Brake - Right Front Line Straight at Center - 7-1/4" Axle
BB1039	1967	Power Drum Brake - Right Front Line Straight at Center - 8-3/4" Axle
BB1040	1967	Power Drum Brake - Right Front Line Straight at Center - Dana Axle
BB1041	1967	Power Disc Brake - Right Front Line Straight at Center - 7-1/4" Axle
BB1042	1967	Power Disc Brake - Right Front Line Straight at Center - 8-3/4" Axle
BB1043	1967	Power Disc Brake - Right Front Line Straight at Center - Dana Axle
BB1044	1967	Power Drum Brake - Right Front Line 4" Rise at Center - 7-1/4" Axle
BB1045	1967	Power Drum Brake - Right Front Line 4" Rise at Center - 8-3/4" Axle
BB1046	1967	Power Drum Brake - Right Front Line 4" Rise at Center - Dana Axle
BB1047	1967	Power Disc Brake - Right Front Line 4" Rise at Center - 7-1/4" Axle
BB1048	1967	Power Disc Brake - Right Front Line 4" Rise at Center - 8-3/4" Axle
BB1049	1967	Power Disc Brake - Right Front Line 4" Rise at Center - Dana Axle
BB1050	1968-69	Standard Drum Brake - Right Front Routes Under Frame - 7-1/4" Axle
BB1051	1968-69	Standard Drum Brake - Right Front Line Routes Under Frame - 8-3/4" Axle
BB1052	1968-69	Standard Drum Brake - Right Front Line Routes Under Frame - Dana Axle
BB1054	1968-69	Standard Disc Brake - Right Front Line Routes Under Frame - 7-1/4" Axle
BB1055	1968-69	Standard Disc Brake - Right Front Line Routes Under Frame - 8-3/4" Axle
BB1056	1968-69	Standard Disc Brake - Right Front Line Routes Under Frame - Dana Axle
BB1058	1968-69	Standard Drum Brake - Right Front Line Routes Over Frame - 7-1/4" Axle
BB1059	1968-69	Standard Drum Brake - Right Front Line Routes Over Frame - 8-3/4" Axle
BB1060	1968-69	Standard Drum Brake - Right Front Line Routes Over Frame - Dana Axle
BB1062	1968-69	Standard Disc Brake - Right Front Line Routes Over Frame - 7-1/4" Axle
BB1063	1968-69	Standard Disc Brake - Right Front Line Routes Over Frame - 8-3/4" Axle
BB1064	1968-69	Standard Disc Brake - Right Front Line Routes Over Frame - Dana Axle
BB1066	1968-69	Power Drum Brake - Right Front Line Routes Under Frame - 7-1/4" Axle
BB1067	1968-69	Power Drum Brake & Hemi - Right Front Line Routes Under Frame - 8-3/4" Axle
BB1068	1968-69	Power Drum Brake & Hemi - Right Front Line Routes Under Frame - Dana Axle
BB1070	1968-69	Power Disc - Right Front Routes Under Frame - Left Ported Master Cylinder - 7-1/4" Axle (2 Pc. Front to Rear) (1969 - Without Metering Valve)
BB1071	1968-69	Power Disc Brake & Hemi - Right Front Line Routes Under Frame - 8-3/4" Axle
BB1072	1968-69	Power Disc Brake & Hemi - Right Front Line Routes Under Frame - Dana Axle
BB1074	1968-69	Power Drum Brake - Right Front Line Routes Over Frame - 7-1/4" Axle
BB1075	1968-69	Power Drum Brake & Hemi - Right Front Line Routes Over Frame - 8-3/4" Axle
BB1076	1968-69	Power Drum Brake & Hemi - Right Front Line Routes Over Frame - Dana Axle
BB1078	1968-69	Power Disc Brake - Right Front Line Routes Over Frame - 7-1/4" Axle
BB1079	1968-69	Power Disc Brake & Hemi - Right Front Line Routes Over Frame - 8-3/4" Axle
BB1080	1968-69	Power Disc Brake & Hemi - Right Front Line Routes Over Frame - Dana Axle
BB1090	1968-69	Power Disc - Right Front Line Routes Under Frame - Master Cylinder Right Ported - 7-1/4" Axle
BB1091	1968-69	Power Disc - Right Front Routes Under Frame - Right Ported Master Cylinder - 8-3/4" Axle (2 Pc. Front to Rear) (1969 without Metering Valve)
BB1092	1968-69	Power Disc - Right Front Line Routes Under Frame - Master Cylinder Right Ported - Dana Axle

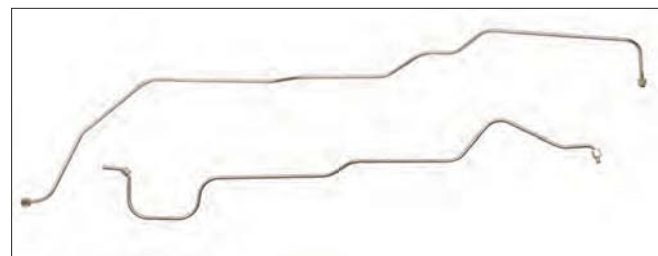

BB1094	1968-69	Power Disc - Right Front Line Routes Over Frame - Master Cylinder Right Ported - 7-1/4" Axle
BB1095	1968-69	Power Disc - Right Front Line Routes Over Frame - Master Cylinder Right Ported - 8-3/4" Axle
BB1096	1968-69	Power Disc - Right Front Line Routes Over Frame - Master Cylinder Right Ported - Dana Axle
BB1129	1969	Standard Disc - Right Front Routes Over Frame - 8-3/4" Axle - With Metering Valve (1 Pc. Front to Rear)
BB1130	1969	Standard Disc - Right Front Routes Over Frame - 7-1/4" Axle - With Metering Valve (1 Pc. Front to Rear)
BB1131	1969	Standard Disc - Right Front Routes Under Frame - 8-3/4" Axle - With Metering Valve (1 Pc. Front to Rear)
BB1132	1969	Standard Disc - Right Front Routes Under Frame - 7-1/4" Axle - With Metering Valve (1 Pc. Front to Rear)
BB1133	1969	Power Disc - Right Front Routes Over Frame - 8-3/4" Axle - Left Ported Master Cylinder - With Metering Valve (2 Pc. Front to Rear)
BB1134	1969	Power Disc - Right Front Routes Over Frame - 7-1/4" Axle - Left Ported Master Cylinder - With Metering Valve (2 Pc. Front to Rear)
BB1135	1969	Power Disc - Right Front Routes Over Frame - 8-3/4" Axle - Right Ported Master Cylinder - With Metering Valve (2 Pc. Front to Rear)
BB1136	1969	Power Disc - Right Front Routes Over Frame - 7-1/4" Axle - Right Ported Master Cylinder - With Metering Valve (2 Pc. Front to Rear)
BB1137	1969	Power Disc - Right Front Routes Under Frame - 8-3/4" Axle - Left Ported Master Cylinder - With Metering Valve (2 Pc. Front to Rear)
BB1138	1969	Power Disc - Right Front Routes Under Frame - 7-1/4" Axle - Left Ported Master Cylinder - With Metering Valve (2 Pc. Front to Rear)
BB1140	1969	Power Disc - Right Front Routes Under Frame - 7-1/4" Axle - Right Ported Master Cylinder - With Metering Valve (2 Pc. Front to Rear)
BB1169	1969	Standard Disc - Right Front Routes Over Frame - Dana Axle - With Metering Valve (1 Pc. Front to Rear)
BB1170	1969	Standard Disc - Right Front Routes Under Frame - Dana Axle - With Metering Valve (1 Pc. Front to Rear)
BB1171	1969	Power Disc - Right Front Routes Over Frame - Left Ported Master Cylinder - Dana Axle - With Metering Valve (2 Pc. Front to Rear)
BB1172	1969	Power Disc - Right Front Routes Over Frame - Right Ported Master Cylinder - Dana - With Metering Valve (2 Pc. Front to Rear)
BB1173	1969	Power Disc - Right Front Routes Under Frame - Left Ported Master Cylinder - Dana Axle - With Metering Valve (2 Pc. Front to Rear)
BB1174	1969	Power Disc - Right Front Routes Under Frame - Right Ported Master Cylinder - Dana Axle - With Metering Valve (2 Pc. Front to Rear)
BB1050	1970	Standard Drum Brake - Right Front Routes Under Frame - 7-1/4" Axle
BB1053	1970	Standard Drum Brake - Right Front Line Routes Under Frame - 8-3/4" and Dana Axle
BB1057	1970	Standard Disc Brake - Right Front Line Routes Under Frame - 8-3/4" and Dana Axle
BB1061	1970	Standard Disc Brake - Right Front Line Routes Over Frame - 8-3/4" and Dana Axle
BB1065	1970	Standard Drum Brake - Right Front Line Routes Over Frame - 8-3/4" and Dana Axle
BB1069	1970	Power Drum Brake & Hemi - Right Front Line Routes Under Frame - 8-3/4" and Dana Axle
BB1073	1970	Power Disc Brake & Hemi - Right Front Line Routes Under Frame - 8-3/4" and Dana Axle
BB1077	1970	Power Drum Brake & Hemi - Right Front Line Routes Over Frame - 8-3/4" and Dana Axle
BB1081	1970	Power Disc Brake & Hemi - Right Front Line Routes Over Frame - 8-3/4" and Dana Axle
BB1085	1970	Standard Disc - Right Front Line Routes Under Frame - Master Cylinder Left Ported - 8-3/4" and Dana Axle

# PLYMOUTH

Cont. from previous page

BB1089	1970	Standard Disc - Right Front Line Routes Over Frame - Master Cylinder Left Ported - 8-3/4" and Dana Axle
BB1093	1970	Power Disc - Right Front Line Routes Under Frame - Master Cylinder Right Ported - 8-3/4" and Dana Axle
BB1097	1970	Power Disc - Right Front Line Routes Over Frame - Master Cylinder Right Ported - 8-3/4" and Dana Axle
BB1102	1970	Power Disc & Hemi - Right Front Line Routes Under Frame - Master Cylinder Left Ported - 8-3/4" and Dana Axle
BB1106	1970	Power Disc & Hemi - Right Front Line Routes Over Frame - Master Cylinder Left Ported - 8-3/4" and Dana Axle
BB1143	1970	Power Disc - Right Front Line straight at Center - Dana Axle
BB1144	1970	Power Disc - Right Front Line 4" Rise at Center - 7-1/4" Axle
BB1147	1970	Standard Disc - Right Front Routes Over Frame - 8-3/4" and Dana Axle - With Metering Valve (1 Pc. Front to Rear)
BB1148	1970	Power Disc - Right Front Line 4" Rise at Center - 8-3/4" Axle
BB1149	1970	Standard Disc - Right Front Routes Under Frame - 8-3/4" and Dana Axle - With Metering Valve (1 Pc. Front to Rear)
BB1151	1970	Power Disc - Right Front Routes Over Frame - Left Ported Master Cylinder - 8-3/4" and Dana Axle W/ Metering Valve (2 Pc. Front to Rear)
BB1153	1970	GTX Power Disc - Right Front Routes Over Frame - Right Ported Master Cylinder - 8-3/4" and Dana Axle - W/ Metering Valve (2 Pc. Front to Rear)
BB1155	1970	Power Disc - Right Front Routes Under Frame - Left Ported Master Cylinder - 8-3/4" and Dana Axle W/ Metering Valve (2 Pc. Front to Rear)
BB1157	1970	Power Disc - Right Front Routes Under Frame - Right Ported Master Cylinder - 8-3/4" and Dana Axle W/ Metering Valve (2 Pc. Front to Rear)
BB1158	1970	Standard Drum - Right Front Routes Over Frame 7-1/4" Axle
BB1107	1971	Standard Drum - 8-3/4" and Dana Axle
BB1110	1971	Power Drum - 8-3/4" and Dana Axle
BB1113	1971	Standard Disc - 8-3/4" and Dana Axle
BB1116	1971	Power Disc - 8-3/4" and Dana Axle

Fuel - Tank To Pump Line			GTX	
Part No.	Year	Description	O.E. Steel	Stainless Steel
PYF1006	1956-58			
BBF1005	1968-69	Small Block - 5/16"		
BBF1006	1968-69	Big Block & Hemi - 3/8"		
BBF1011	1970	Small Block - 5/16"		
BBF1012	1970	Big Block & Hemi - 3/8"		
BBF1007	1971-72	Small Block - 5/16"		
BBF1008	1971-72	Small Block - 5/16"		

Fuel - Return Line			GTX	
Part No.	Year	Description	O.E. Steel	Stainless Steel
BBR1002	1968-69	Big Block and Hemi - 1/4"		
BBR1004	1970	1/4"		

Fuel - Vapor Line			GTX	
Part No.	Year	Description	O.E. Steel	Stainless Steel
BBV1001	1970	5/16" (2 Pc.)		
BBV1002	1971-72	5/16" (2 Pc.)		

Transmission Lines (Sold In Pairs)			GTX	
Part No.	Year	Description	O.E. Steel	Stainless Steel
BBT1001	1966-68	Big Block		
BBT1002	1969	Transmission to Radiator - Radiator to Aux Cooler (4 Pc.)		
BBT1004	1969-70	Big Block - with Oil Filter at Radiator - Drivers Side		
BBT1011	1970	Hemi - with Aux Cooler (4 Pc.)		
BBT1015	1971	Small Block - with 727 Transmission		
BBT1005	1971	Small Block - 904 Transmission		
BBT1006	1971-72	Big Block - 727 Transmission		
BBT1013	1972-74	Hemi - 727 with Aux Cooler (4 Pc.)		

## ROAD RUNNER

Complete Brake Line Kit			Road Runner	
Part No.	Year	Description	O.E. Steel	Stainless Steel
BB1051	1968-69	Standard Drum - Right Front Routes Under Frame - 8-3/4" Axle (1 Pc. Front to Rear)		
BB1052	1968-69	Standard Drum - Right Front Routes Under Frame - Dana Axle (1 Pc. Front to Rear)		
BB1054	1968-69	Standard Disc Brake - Right Front Line Routes Under Frame - 7-1/4" Axle		
BB1055	1968-69	Standard Disc - Right Front Routes Under Frame - 8-3/4" Axle (2 Pc. Front to Rear) (1969 - Without Metering Valve)		
BB1056	1968-69	Standard Disc Brake - Right Front Line Routes Under Frame - Dana Axle		
BB1058	1968-69	Standard Drum Brake - Right Front Line Routes Over Frame - 7-1/4" Axle		
BB1059	1968-69	Standard Drum Brake - Right Front Line Routes Over Frame - 8-3/4" Axle		

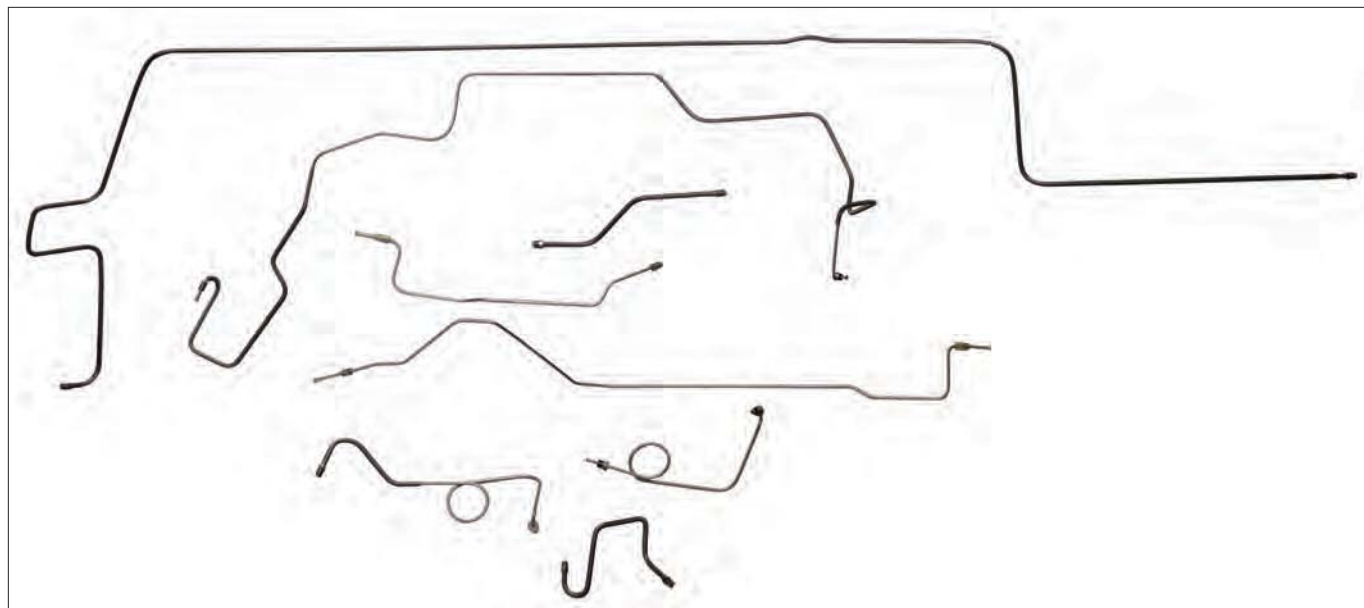

# PLYMOUTH

BB1060	1968-69	Standard Drum Brake - Right Front Line Routes Over Frame - Dana Axle
BB1063	1968-69	Standard Disc Brake - Right Front Line Routes Over Frame - 8-3/4" Axle
BB1064	1968-69	Standard Disc Brake - Right Front Line Routes Over Frame - Dana Axle
BB1067	1968-69	Power Drum Brake & Hemi - Right Front Line Routes Under Frame - 8-3/4" Axle
BB1068	1968-69	Power Drum Brake & Hemi - Right Front Line Routes Under Frame - Dana Axle
BB1071	1968-69	Power Disc - Right Front Routes Under Frame - Left Ported Master Cylinder - 8-3/4" Axle (2 Pc. Front to Rear) (1969 without Metering Valve)
BB1072	1968-69	Power Disc - Right Front Routes Under Frame - Left Ported Master Cylinder - Dana Axle (2 Pc. Front to Rear) (1969 without Metering Valve)
BB1075	1968-69	Power Drum - Right Front Routes Over Frame - 8-3/4" Axle (1 Pc. Front to Rear)
BB1076	1968-69	Power Drum - Right Front Routes Over Frame - Dana Axle (1 Pc. Front to Rear)
BB1079	1968-69	Power Disc - Right Front Routes Over Frame - 8-3/4" Axle - Left Ported Master Cylinder (2 Pc. Front to Rear) (1969 without Metering Valve)
BB1080	1968-69	Power Disc Brake & Hemi - Right Front Line Routes Over Frame - Dana Axle
BB1091	1968-69	Power Disc - Right Front Routes Under Frame - Right Ported Master Cylinder - 8-3/4" Axle (2 Pc. Front to Rear) (1969 without Metering Valve)
BB1092	1968-69	Power Disc - Right Front Routes Under Frame - Right Ported Master Cylinder - Dana Axle (2 Pc. Front to Rear) (1969 without Metering Valve)
BB1095	1968-69	Power Disc - Right Front Line Routes Over Frame - Master Cylinder Right Ported - 8-3/4" Axle
BB1096	1968-69	Power Disc - Right Front Routes Over Frame - Right Ported Master Cylinder - Dana Axle (2 Pc. Front to Rear) (1969 without Metering Valve)
BB1129	1969	Standard Disc - Right Front Routes Over Frame - 8-3/4" Axle - With Metering Valve (1 Pc. Front to Rear)
BB1131	1969	Standard Disc - Right Front Routes Under Frame - 8-3/4" Axle - With Metering Valve (1 Pc. Front to Rear)
BB1133	1969	Power Disc - Right Front Routes Over Frame - 8-3/4" Axle - Left Ported Master Cylinder - With Metering Valve (2 Pc. Front to Rear)
BB1135	1969	Power Disc - Right Front Routes Over Frame - 8-3/4" Axle - Right Ported Master Cylinder - With Metering Valve (2 Pc. Front to Rear)
BB1137	1969	Power Disc - Right Front Routes Under Frame - 8-3/4" Axle - Left Ported Master Cylinder - With Metering Valve (2 Pc. Front to Rear)
BB1139	1969	Power Disc - Right Front Routes Under Frame - 8-3/4" Axle - Right Ported Master Cylinder - With Metering Valve (2 Pc. Front to Rear)
BB1080	1969	Power Disc - Right Front Routes Over Frame - Dana Axle - Left Ported Master Cylinder (2 Pc. Front to Rear) (1969 - Without Metering Valve)
BB1053	1970	Standard Drum Brake - Right Front Line Routes Under Frame - 8-3/4" and Dana Axle
BB1056	1970	Standard Disc - Right Front Routes Over Frame - Dana Axle
BB1057	1970	Standard Disc Brake - Right Front Line Routes Under Frame - 8-3/4" and Dana Axle
BB1158	1970	Standard Drum - Right Front Routes Over Frame 7-1/4" Axle
BB1061	1970	Standard Disc Brake - Right Front Line Routes Over Frame - 8-3/4" and Dana Axle
BB1065	1970	Standard Drum Brake - Right Front Line Routes Over Frame - 8-3/4" and Dana Axle
BB1069	1970	Power Drum Brake & Hemi - Right Front Line Routes Under Frame - 8-3/4" and Dana Axle
BB1073	1970	Power Disc - Right Front Routes Under Frame - 8-3/4" and Dana Axle - Left Ported Master Cylinder without Metering Valve (2 Pc. Front to Rear)
BB1077	1970	Power Drum - Right Front Routes Over Frame - 8-3/4" and Dana Axle (1 Pc. Front to Rear)
BB1081	1970	Power Disc - Right Front Routes Over Frame - 8-3/4" and Dana Axle - Left Ported Master Cylinder without Metering Valve (2 Pc. Front to Rear)
BB1093	1970	Power Disc - Right Front Line Routes Under Frame - Master Cylinder Right Ported - 8-3/4" and Dana Axle
BB1097	1970	Power Disc - Right Front Routes Over Frame - Right Ported Master Cylinder - 8-3/4" and Dana Axle without Metering Valve (2 Pc. Front to Rear)
BB1147	1970	Standard Disc - Right Front Routes Over Frame - 8-3/4" and Dana Axle - With Metering Valve (1 Pc. Front to Rear)
BB1149	1970	Standard Disc - Right Front Routes Under Frame - 8-3/4" and Dana Axle - With Metering Valve (1 Pc. Front to Rear)
BB1151	1970	Power Disc - Right Front Routes Over Frame - Left Ported Master Cylinder - 8-3/4" and Dana Axle W/ Metering Valve (2 Pc. Front to Rear)



BB1152	1970	Power Disc - Right Front Routes Under Frame - Left Ported Master Cylinder - 7-1/4" Axle W/ Metering Valve
BB1153	1970	Power Disc - Right Front Routes Over Frame - Right Ported Master Cylinder - 8-3/4" and Dana Axle W/ Metering Valve (2 Pc. Front to Rear)
BB1155	1970	Power Disc - Right Front Routes Under Frame - Left Ported Master Cylinder - 8-3/4" and Dana Axle W/ Metering Valve (2 Pc. Front to Rear)
BB1107	1971	Standard Drum - 8-3/4" and Dana Axle
BB1110	1971	Power Drum - 8-3/4" and Dana Axle
BB1113	1971	Standard Disc - 8-3/4" and Dana Axle
BB1116	1971	Power Disc - 8-3/4" and Dana Axle
BB1121	1973	Standard Disc - 8-3/4" and Dana Axle
BB1122	1973	Power Disc - 8-3/4" and Dana Axle
BB1165	1974	Standard Disc - 8-3/4" and Dana Axle
BB1166	1974	Power Disc - 8-3/4" and Dana Axle

Fuel - Tank To Pump Line			Road Runner	
Part No.	Year	Description	O.E. Steel	Stainless Steel
BBF1005	1968-69	Small Block - 5/16"		
BBF1006	1968-69	Big Block & Hemi - 3/8"		
BBF1011	1970	Small Block - 5/16"		
BBF1012	1970	Big Block & Hemi - 3/8"		
BBF1007	1971-72	Small Block - 5/16"		
BBF1008	1971-72	Big Block & Hemi - 3/8"		
BBF1009	1973-74	Small Block - 5/16"		
BBF1010	1973-74	Big Block - 3/8"		

Fuel - Return Line			Road Runner	
Part No.	Year	Description	O.E. Steel	Stainless Steel
BBR1002	1968-69	Big Block and Hemi - 1/4"		
BBR1004	1970	1/4"		
BBR1003	1973-74	1/4" (2 Pc.)		

Fuel - Vapor Line			Road Runner	
Part No.	Year	Description	O.E. Steel	Stainless Steel
BBV1001	1970	5/16" (2 Pc.)		
BBV1002	1971-72	5/16" (2 Pc.)		

Transmission Lines (Sold In Pairs)			Road Runner	
Part No.	Year	Description	O.E. Steel	Stainless Steel
BBT1001	1966-68	Big Block		
BBT1002	1969	Transmission to Radiator - Radiator to Aux Cooler (4 Pc.)		
BBT1004	1969-70	Big Block - with Oil Filter at Radiator - Drivers Side		
BBT1011	1970	Hemi - with Aux Cooler (4 Pc.)		
BBT1015	1971	Small Block - with 727 Transmission		
BBT1005	1971-74	Small Block - 904 Transmission		
BBT1006	1971-74	Big Block - 727 Transmission		
BBT1010	1971-74	Small Block - A727 Transmission		
BBT1013	1972-74	Hemi - 727 with Aux Cooler (4 Pc.)		

# PLYMOUTH

## SATELLITE

### Complete Brake Line Kit

Part No.	Year	Description	O.E. Steel	Stainless Steel
BB1175	1964	Standard Brake		
BB1002	1964-65	Power Brake		
BB1001	1965	Standard Brake		
BB1003	1966	Standard Brake - Right Line Straight at Center - Drum - 7-1/4" Axle		
BB1004	1966	Standard Brake - Right Front Line Straight at Center - Drum - 8-3/4" Axle		
BB1005	1966	Standard Brake - Right Front Line Straight at Center - Drum - Dana Axle		
BB1009	1966	Standard Brake - Right Front Line 4" Rise at Center - Drum - 7-1/4" Axle		
BB1010	1966	Standard Brake - Right Front Line 4" Rise at Center - Drum - 8-3/4" Axle		
BB1011	1966	Standard Brake - Right Front Line 4" Rise at Center - Drum - Dana Axle		
BB1015	1966	Power Brake - Right Front Line Straight at Center - Drum - 7-1/4" Axle		
BB1016	1966	Power Brake & Hemi - Right Front Line Straight at Center - Drum - 8-3/4" Axle		
BB1017	1966	Power Brake & Hemi - Right Front Line Straight at Center - Drum - Dana Axle		
BB1020	1966	Power Brake - Right Front Line 4" Rise at Center - Drum - 7-1/4" Axle		
BB1021	1966	Power Brake & Hemi - Right Front Line 4" Rise at Center - Drum - 8-3/4" Axle		
BB1022	1966	Power Brake & Hemi - Right Front Line 4" Rise at Center - Drum - Dana Axle		
BB1026	1967	Standard Drum Brake - Right Front Line Straight at Center - 7-1/4" Axle		
BB1027	1967	Standard Drum Brake - Right Front Line Straight at Center - 8-3/4" Axle		
BB1028	1967	Standard Drum Brake - Right Front Line Straight at Center - Dana Axle		
BB1029	1967	Standard Disc Brake - Right Front Line Straight at Center - 7-1/4" Axle		
BB1030	1967	Standard Disc Brake - Right Front Line Straight at Center - 8-3/4" Axle		
BB1031	1967	Standard Disc Brake - Right Front Line Straight at Center - Dana Axle		
BB1032	1967	Standard Drum Brake - Right Front Line 4" Rise at Center - 7-1/4" Axle		
BB1033	1967	Standard Drum Brake - Right Front Line 4" Rise at Center - 8-3/4" Axle		
BB1034	1967	Standard Drum Brake - Right Front Line 4" Rise at Center - Dana Axle		
BB1035	1967	Standard Disc Brake - Right Front Line 4" Rise at Center - 7-1/4" Axle		
BB1036	1967	Standard Disc Brake - Right Front Line 4" Rise at Center - 8-3/4" Axle		
BB1037	1967	Standard Disc Brake - Right Front Line 4" Rise at Center - Dana Axle		
BB1038	1967	Power Drum Brake - Right Front Line Straight at Center - 7-1/4" Axle		
BB1039	1967	Power Drum Brake - Right Front Line Straight at Center - 8-3/4" Axle		
BB1040	1967	Power Drum Brake - Right Front Line Straight at Center - Dana Axle		
BB1041	1967	Power Disc Brake - Right Front Line Straight at Center - 7-1/4" Axle		
BB1042	1967	Power Disc Brake - Right Front Line Straight at Center - 8-3/4" Axle		
BB1043	1967	Power Disc Brake - Right Front Line Straight at Center - Dana Axle		
BB1044	1967	Power Drum Brake - Right Front Line 4" Rise at Center - 7-1/4" Axle		
BB1045	1967	Power Drum Brake - Right Front Line 4" Rise at Center - 8-3/4" Axle		
BB1046	1967	Power Drum Brake - Right Front Line 4" Rise at Center - Dana Axle		
BB1047	1967	Power Disc Brake - Right Front Line 4" Rise at Center - 7-1/4" Axle		

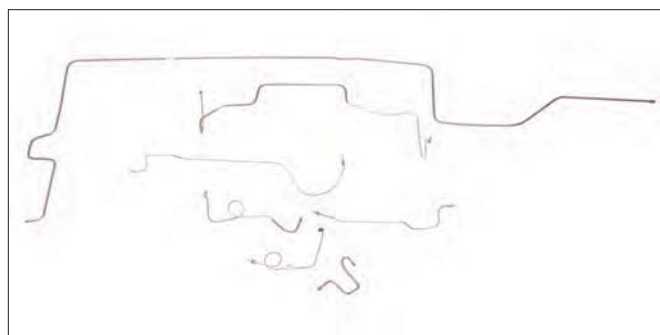

BB1048	1967	Power Disc Brake - Right Front Line 4" Rise at Center - 8-3/4" Axle
BB1049	1967	Power Disc Brake - Right Front Line 4" Rise at Center - Dana Axle
BB1050	1968-69	Standard Drum Brake - Right Front Routes Under Frame - 7-1/4" Axle
BB1051	1968-69	Standard Drum Brake - Right Front Line Routes Under Frame - 8-3/4" Axle
BB1052	1968-69	Standard Drum Brake - Right Front Line Routes Under Frame - Dana Axle
BB1054	1968-69	Standard Disc Brake - Right Front Line Routes Under Frame - 7-1/4" Axle
BB1055	1968-69	Standard Disc Brake - Right Front Line Routes Under Frame - 8-3/4" Axle
BB1056	1968-69	Standard Disc Brake - Right Front Line Routes Under Frame - Dana Axle
BB1058	1968-69	Standard Drum Brake - Right Front Line Routes Over Frame - 7-1/4" Axle
BB1059	1968-69	Standard Drum Brake - Right Front Line Routes Over Frame - 8-3/4" Axle
BB1060	1968-69	Standard Drum Brake - Right Front Line Routes Over Frame - Dana Axle
BB1062	1968-69	Standard Disc Brake - Right Front Line Routes Over Frame - 7-1/4" Axle
BB1063	1968-69	Standard Disc Brake - Right Front Line Routes Over Frame - 8-3/4" Axle
BB1064	1968-69	Standard Disc Brake - Right Front Line Routes Over Frame - Dana Axle
BB1066	1968-69	Power Drum Brake - Right Front Line Routes Under Frame - 7-1/4" Axle
BB1067	1968-69	Power Drum Brake & Hemi - Right Front Line Routes Under Frame - 8-3/4" Axle
BB1068	1968-69	Power Drum Brake & Hemi - Right Front Line Routes Under Frame - Dana Axle
BB1070	1968-69	Power Disc Brake - Right Front Line Routes Under Frame - 7-1/4" Axle
BB1071	1968-69	Power Disc Brake & Hemi - Right Front Line Routes Under Frame - 8-3/4" Axle
BB1072	1968-69	Power Disc Brake & Hemi - Right Front Line Routes Under Frame - Dana Axle
BB1074	1968-69	Power Drum Brake - Right Front Line Routes Over Frame - 7-1/4" Axle
BB1075	1968-69	Power Drum Brake & Hemi - Right Front Line Routes Over Frame - 8-3/4" Axle
BB1076	1968-69	Power Drum Brake & Hemi - Right Front Line Routes Over Frame - Dana Axle
BB1078	1968-69	Power Disc Brake - Right Front Line Routes Over Frame - 7-1/4" Axle
BB1079	1968-69	Power Disc Brake & Hemi - Right Front Line Routes Over Frame - 8-3/4" Axle
BB1080	1968-69	Power Disc Brake & Hemi - Right Front Line Routes Over Frame - Dana Axle
BB1090	1968-69	Power Disc - Right Front Routes Under Frame - Right Ported Master Cylinder - 7-1/4" Axle (2 Pc. Front to Rear) (1969 without Metering Valve)
BB1091	1968-69	Power Disc - Right Front Routes Under Frame - Right Ported Master Cylinder - 8-3/4" Axle (2 Pc. Front to Rear) (1969 without Metering Valve)
BB1092	1968-69	Power Disc - Right Front Routes Under Frame - Right Ported Master Cylinder - Dana Axle (2 Pc. Front to Rear) (1969 without Metering Valve)
BB1094	1968-69	Power Disc - Right Front Routes Over Frame - Right Ported Master Cylinder - 7-1/4" Axle (2 Pc. Front to Rear) (1969 without Metering Valve)
BB1095	1968-69	Power Disc - Right Front Routes Over Frame - Right Ported Master Cylinder - 8-3/4" Axle (2 Pc. Front to Rear) (1969 without Metering Valve)
BB1096	1968-69	Power Disc - Right Front Routes Over Frame - Right Ported Master Cylinder - Dana Axle (2 Pc. Front to Rear) (1969 without Metering Valve)
BB1129	1969	Standard Disc - Right Front Routes Over Frame - 8-3/4" Axle - With Metering Valve (1 Pc. Front to Rear)
BB1130	1969	Standard Disc - Right Front Routes Over Frame - 7-1/4" Axle - With Metering Valve (1 Pc. Front to Rear)
BB1131	1969	Standard Disc - Right Front Routes Under Frame - 8-3/4" Axle - With Metering Valve (1 Pc. Front to Rear)
BB1132	1969	Standard Disc - Right Front Routes Under Frame - 7-1/4" Axle - With Metering Valve (1 Pc. Front to Rear)
BB1133	1969	Power Disc - Right Front Routes Over Frame - 8-3/4" Axle - Left Ported Master Cylinder - With Metering Valve (2 Pc. Front to Rear)
BB1134	1969	Power Disc - Right Front Routes Over Frame - 7-1/4" Axle - Left Ported Master Cylinder - With Metering Valve (2 Pc. Front to Rear)
BB1135	1969	Power Disc - Right Front Routes Over Frame - 8-3/4" Axle - Right Ported Master Cylinder - With Metering Valve (2 Pc. Front to Rear)

# PLYMOUTH

BB1136	1969	Power Disc - Right Front Routes Over Frame - 7-1/4" Axle - Right Ported Master Cylinder - With Metering Valve (2 Pc. Front to Rear)
BB1137	1969	Power Disc - Right Front Routes Under Frame - 8-3/4" Axle - Left Ported Master Cylinder - With Metering Valve (2 Pc. Front to Rear)
BB1138	1969	Power Disc - Right Front Routes Under Frame - 7-1/4" Axle - Left Ported Master Cylinder - With Metering Valve (2 Pc. Front to Rear)
BB1140	1969	Power Disc - Right Front Routes Under Frame - 7-1/4" Axle - Right Ported Master Cylinder - With Metering Valve (2 Pc. Front to Rear)
BB1169	1969	Standard Disc - Right Front Routes Over Frame - Dana Axle - With Metering Valve (1 Pc. Front to Rear)
BB1170	1969	Standard Disc - Right Front Routes Under Frame - Dana Axle - With Metering Valve (1 Pc. Front to Rear)
BB1171	1969	Power Disc - Right Front Routes Over Frame - Left Ported Master Cylinder - Dana Axle - With Metering Valve (2 Pc. Front to Rear)
BB1172	1969	Power Disc - Right Front Routes Over Frame - Right Ported Master Cylinder - Dana - With Metering Valve (2 Pc. Front to Rear)
BB1173	1969	Power Disc - Right Front Routes Under Frame - Left Ported Master Cylinder - Dana Axle - With Metering Valve (2 Pc. Front to Rear)
BB1174	1969	Power Disc - Right Front Routes Under Frame - Right Ported Master Cylinder - Dana Axle - With Metering Valve (2 Pc. Front to Rear)
BB1050	1970	Standard Drum Brake - Right Front Routes Under Frame - 7-1/4" Axle
BB1053	1970	Standard Drum - Right Front Routes Under Frame - 8-3/4" and Dana Axle (1 Pc. Front to Rear)
BB1057	1970	Standard Disc - Right Front Routes Under Frame - 8-3/4" and Dana Axle - Without Metering Valve (2 Pc. Front to Rear)
BB1061	1970	Standard Disc Brake - Right Front Line Routes Over Frame - 8-3/4" and Dana Axle
BB1065	1970	Standard Drum Brake - Right Front Line Routes Over Frame - 8-3/4" and Dana Axle
BB1069	1970	Power Drum Brake & Hemi - Right Front Line Routes Under Frame - 8-3/4" and Dana Axle
BB1073	1970	Power Disc Brake & Hemi - Right Front Line Routes Under Frame - 8-3/4" and Dana Axle
BB1077	1970	Power Drum Brake & Hemi - Right Front Line Routes Over Frame - 8-3/4" and Dana Axle
BB1081	1970	Power Disc Brake & Hemi - Right Front Line Routes Over Frame - 8-3/4" and Dana Axle
BB1085	1970	Standard Disc - Right Front Line Routes Under Frame - Master Cylinder Left Ported - 8-3/4" and Dana Axle
BB1089	1970	Standard Disc - Right Front Line Routes Under Frame - Master Cylinder Right Ported - 8-3/4" and Dana Axle
BB1093	1970	Power Disc - Right Front Line Routes Under Frame - Master Cylinder Right Ported - 8-3/4" and Dana Axle
BB1097	1970	Power Disc - Right Front Line Routes Over Frame - Master Cylinder Right Ported - 8-3/4" and Dana Axle
BB1102	1970	Power Disc & Hemi - Right Front Line Routes Under Frame - Master Cylinder Left Ported - 8-3/4" and Dana Axle
BB1106	1970	Power Disc & Hemi - Right Front Line Routes Over Frame - Master Cylinder Left Ported - 8-3/4" and Dana Axle
BB1143	1970	Power Disc - Right Front Line straight at Center - Dana Axle
BB1144	1970	Power Disc - Right Front Line 4" Rise at Center - 7-1/4" Axle
BB1147	1970	Standard Disc - Right Front Routes Over Frame - 8-3/4" and Dana Axle - With Metering Valve (1 Pc. Front to Rear)
BB1148	1970	Power Disc - Right Front Line 4" Rise at Center - 8-3/4" Axle
BB1149	1970	Standard Disc - Right Front Routes Under Frame - 8-3/4" and Dana Axle - With Metering Valve (1 Pc. Front to Rear)
BB1151	1970	Power Disc - Right Front Routes Over Frame - Left Ported Master Cylinder - 8-3/4" and Dana Axle W/ Metering Valve (2 Pc. Front to Rear)
BB1152	1970	Power Disc - Right Front Routes Under Frame - Left Ported Master Cylinder - 7-1/4" Axle W/ Metering Valve
BB1153	1970	Power Disc - Right Front Routes Over Frame - Right Ported Master Cylinder - 8-3/4" and Dana Axle W/ Metering Valve (2 Pc. Front to Rear)
BB1155	1970	Power Disc - Right Front Routes Under Frame - Left Ported Master Cylinder - 8-3/4" and Dana Axle W/ Metering Valve (2 Pc. Front to Rear)
BB1157	1970	Power Disc - Right Front Routes Under Frame - Right Ported Master Cylinder - 8-3/4" and Dana Axle W/ Metering Valve (2 Pc. Front to Rear)
BB1107	1971	Standard Drum - 8-3/4" and Dana Axle
BB1110	1971	Power Drum - 8-3/4" and Dana Axle
BB1113	1971	Standard Disc - 8-3/4" and Dana Axle
BB1116	1971	Power Disc - 8-3/4" and Dana Axle



BB1121	1973	Standard Disc - 8-3/4" and Dana Axle
BB1122	1973	Power Disc - 8-3/4" Axle
BB1165	1974	Standard Disc - 8-3/4" and Dana Axle
BB1166	1974	Power Disc - 8-3/4" and Dana Axle

Fuel - Pump To Carburetor Line			Satellite
Part No.	Year	Description	O.E. Steel
PYC1002	1973-74	318 CID (2Pc.)	Stainless Steel

Fuel - Tank To Pump Line			Satellite
Part No.	Year	Description	O.E. Steel
BBF1001	1964-65	Small Block - 5/16"	Stainless Steel
BBF1002	1965	Big Block and Hemi - 3/8"	
BBF1004	1966-67	Big Block & Hemi - 3/8"	
BBF1003	1967	Small Block - 5/16"	
BBF1005	1968-69	Small Block - 5/16"	
BBF1006	1968-69	Big Block & Hemi - 3/8"	
BBF1011	1970	Small Block - 5/16"	
BBF1012	1970	Big Block & Hemi - 3/8"	
BBF1007	1971-72	Small Block - 5/16"	
BBF1008	1971-72	Big Block & Hemi - 3/8"	
BBF1009	1973-74	Small Block - 5/16"	
BBF1010	1973-74	Big Block - 3/8"	

Fuel - Return Line			Satellite
Part No.	Year	Description	O.E. Steel
BBR1002	1968-69	Big Block and Hemi - 1/4"	Stainless Steel
BBR1004	1970	1/4"	
BBR1003	1973-74	1/4" (2 Pc.)	

Fuel - Vapor Line			Satellite
Part No.	Year	Description	O.E. Steel
BBV1001	1970	5/16" (2 Pc.)	Stainless Steel
BBV1002	1971-72	5/16" (2 Pc.)	

Transmission Lines (Sold In Pairs)			Satellite
Part No.	Year	Description	O.E. Steel
BTT1007	1965	318 CID	Stainless Steel
BTT1001	1966-68	Big Block	
BTT1003	1966-70	Small Block	
BTT1012	1968	Small Block w/ 727 Torque Flite	
BTT1002	1969	Transmission to Radiator - Radiator to Aux Cooler (4 Pc.)	
BTT1004	1969-70	Big Block - with Oil Filter at Radiator - Drivers Side	
BTT1011	1970	Hemi - with Aux Cooler (4 Pc.)	
BTT1015	1971	Small Block - with 727 Transmission	
BTT1005	1971-74	Small Block - 904 Transmission	

# PLYMOUTH

## VALIANT

### Complete Brake Line Kit

Part No.	Year	Description	Valiant	
			O.E. Steel	Stainless Steel
AB1094	1964-66	Standard Drum - 106" Wheelbase 7-1/4" Axle		
AB1095	1964-66	Power Drum - 106" Wheelbase 7-1/4" Axle		
AB1096	1964-66	Standard Drum - 108" Wheelbase 7-1/4" Axle		
AB1097	1966	Standard Drum - 108" Wheelbase 8-3/4" Axle		
AB1001	1967	Standard Drum - 108" WB - 7-1/4" Axle		
AB1002	1967	Standard Drum - 108" WB - 8-3/4" Axle		
AB1003	1967	Standard Disc - 108" WB - Proportioning Valve on Frame (2 Pc.) - 7-1/4" Axle		
AB1004	1967	Standard Disc - 108" WB - Proportioning Valve on Frame (2 Pc.) - 8-3/4" Axle		
AB1011	1967	Power Drum - 108" WB - 7-1/4" Axle		
AB1012	1967	Power Drum - 108" WB - 8-3/4" Axle		
AB1013	1967	Power Disc - 108" WB - Proportioning Valve on Frame (2 Pc.) - 7-1/4" Axle		
AB1014	1967	Power Disc - 108" WB - Proportioning Valve on Frame (2 Pc.) - 8-3/4" Axle		
AB1053	1968-69	Power Drum - 108" Wheelbase 8-3/4" Axle (1 Pc. Front to Rear)		
AB1057	1968-69	Standard Disc - 108" Wheelbase (2 Pc. Front to Rear) 8-3/4" Axle		
AB1059	1968-69	Power Disc - 108" Wheelbase 8-3/4" Axle (2 Pc. Front to Rear)		
AB1035	1968-70	Power Brakes - 108" WB - 7-1/4" Axle		
AB1021	1968-72	Standard Brakes - 108" WB - 7-1/4" Axle		
AB1022	1968-72	Standard Brakes - 108" WB - 8-3/4" Axle		
AB1023	1970	Standard Disc - 108" WB - Proportioning Valve on Frame (2 Pc.) - 7-1/4" Axle		
AB1024	1970	Standard Disc - 108" WB - Proportioning Valve on Frame (2 Pc.) - 8-3/4" Axle		
AB1037	1970	Power Disc - 108" WB - Proportioning Valve on Frame (2 Pc.) - 7-1/4" Axle		
AB1060	1970	Standard Drum - 108" Wheelbase 8-3/4" Axle (1 Pc. Front to Rear)		
AB1062	1970	Power Drum - 108" Wheelbase 8-3/4" Axle (1 Pc. Front to Rear)		
AB1064	1970	Power Disc - 108" Wheelbase 8-3/4" Axle (2 Pc. Front to Rear)		
AB1065	1971	Standard Brake - 108" Wheelbase 8-3/4" Axle		
AB1098	1971	Standard Brake - 108" Wheelbase 7-1/4" Axle		
AB1100	1971	Power Brake - 108" Wheelbase 7-1/4" Axle		
AB1036	1971-72	Power Brakes - 108" WB - 8-3/4" Axle		
AB1075	1972	Power Drum - 108" Wheelbase 7-1/4" Axle		

AB1077	1972	Standard Disc - 108" Wheelbase 7-1/4" Axle
AB1072	1973-74	Standard Drum - 108" Wheelbase 8-3/4" Axle
AB1102	1973-74	Power Brake - 108" Wheelbase 7-1/4" Axle
AB1103	1973-74	Power Brake - 108" Wheelbase 8-1/4" Axle
AB1029	1973-76	Standard Brakes - 108" WB - 8-3/4" Axle
AB1043	1973-76	Power Brakes - 108" WB - 8-3/4" Axle
AB1090	1975-76	Power Disc - 108" Wheelbase 7-1/4" Axle
AB1092	1975-76	Standard Disc - 108" Wheelbase 7-1/4" Axle
AB1105	1975-76	Power Drum - 108" Wheelbase 8-1/4" Axle
AB1107	1975-76	Standard Disc - 108" Wheelbase 8-1/4" Axle
AB1108	1975-76	Power Disc - 108" Wheelbase 8-1/4" Axle
AB1030	1976	Standard Brakes - 108" WB - 7-1/4" Axle
AB1044	1976	Power Brakes - 108" WB - 7-1/4" Axle

### Fuel - Tank To Pump Line

Part No.	Year	Description	Valiant	
			O.E. Steel	Stainless Steel
ABF1001	1967-68	108" WB 5/16"		
ABF1002	1967-68	108" WB 3/8"		
ABF1005	1969-72	108" WB 5/16"		
ABF1006	1969-72	108" WB 3/8"		
ABF1013	1970-72	108" WB 5/16" - Dual Exhaust		
ABF1009	1973-76	108" WB 5/16"		
ABF1010	1973-76	108" WB 3/8"		

### Fuel - Return Line

Part No.	Year	Description	Valiant	
			O.E. Steel	Stainless Steel
ABR1001	1973-76	108" WB (2 Pc.)		

### Fuel - Vapor Line

Part No.	Year	Description	Valiant	
			O.E. Steel	Stainless Steel
ABV1001	1971-72	108" WB		

### Transmission Lines (Sold In Pairs)

Part No.	Year	Description	Valiant	
			O.E. Steel	Stainless Steel
CYT1010	1964	Slant 6 904		
ABT1010	1964-66	6 Cylinder		
ABT1004	1973	V8 A727 Transmission		

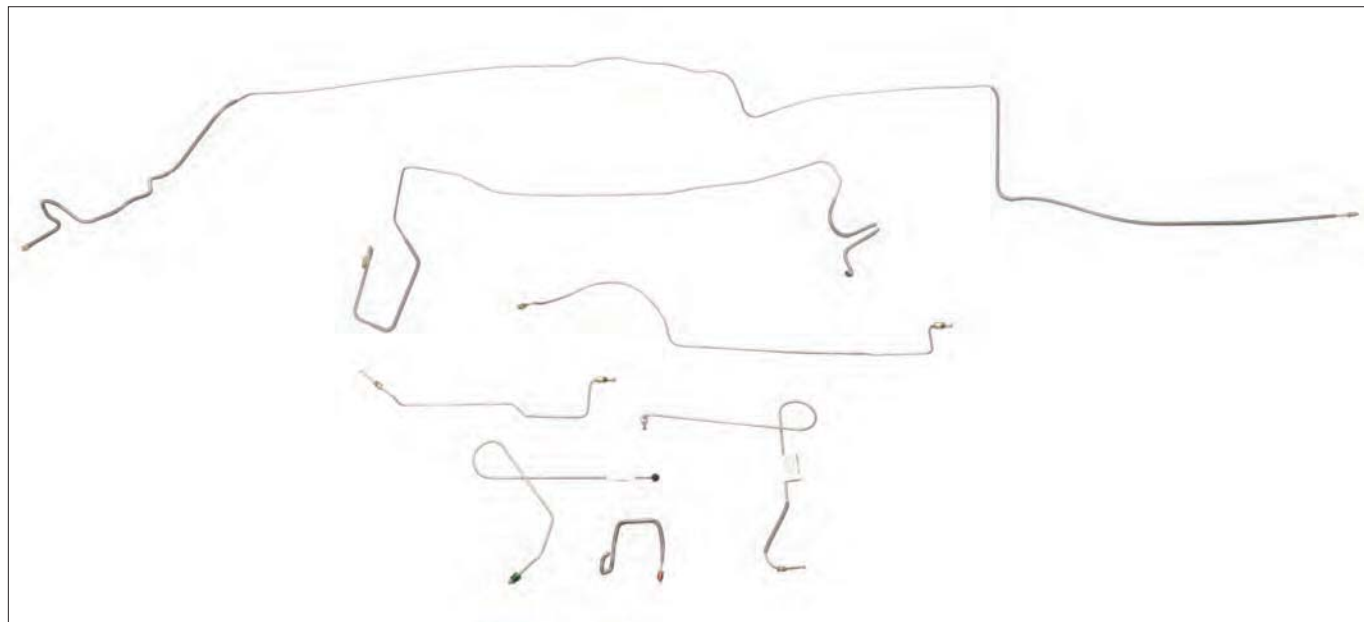

# FORD

## FORD EARLY & MISC.

### Complete Brake Line Kit

Ford Early & Misc.

Part No.	Year	Description	O.E. Steel	Stainless Steel
FD1001	1939	Model 91A		
FD1001	1939	Model 92A		
FD1002	1940	Model 91A		
FD1002	1940	Model 92A		
FD1003	1941-42	Wagon		
FD1004	1941-42	Passenger Cars		
FD1003	1946-48	Wagon		
FD1004	1946-48	Passenger Cars		
FD1005	1949-50			
FD1028	1951			
FD1006	1952-53	All Models		
FD1007	1954-55	All Models		
FD1024	1956	Passenger Cars		
FD1035	1956	4 Door Wagon		
FD1009	1957	Custom Standard Drum		
FD1010	1957	Wagon		
FD1011	1958	Edsel Convertible		
FD1025	1958	All Models Except Fairlane		
FD1012	1959	Ranchero		
FD1033	1960-61	Falcon Standard Drum		
FD1034	1962-63	Falcon Standard Drum - 6 Cylinder 7 1/4" Rear End		
FD1015	1963	Falcon Standard Drum - V8		
FD1016	1964-65	Falcon Standard Drum (5 Pc.)		
FD1038	1964-65	Falcon Wagon V-8		
FR1016	1968-69	Ranchero Standard Drum 8" Axle		
FR1016	1968-69	Falcon Standard Drum - 8" Axle		
FR1018	1968-69	Ranchero Power Disc - 8" Axle		
FR1020	1968-69	Ranchero Power Disc - 9" Axle		
FR1021	1968-69	Ranchero Standard Drum 9" Axle		
FD1045	1970-71	Comet Standard Drum		
FD1045	1970-71	Maverick Grabber Standard Drum		
FD1017	1978-80	Fiesta Power Brake		
FD1047	1978-80	Fiesta Standard Brake		
FD1026	1989	Taurus SHO 4 Door 4 Wheel Disc (6 Pc.)		
FD1037	1996	Crown Victoria		

### Caliper Inlet Lines & Transfer Tubes (Sold in Pairs)

Ford Early & Misc.

Part No.	Year	Description	O.E. Steel	Stainless Steel
FDD1001	1996-99	Taurus and SHO Without ABS - Rear Inlet Line Set		

### Fuel - Pump To Carburetor Line

Ford Early & Misc.

Part No.	Year	Description	O.E. Steel	Stainless Steel
FDC1025	1939-40	Model 91A		
FDC1025	1939-40	Model 92A		
FDC1025	1941-42	Special		
FDC1025	1941-42	Deluxe		
FDC1025	1941-42	Super Deluxe		
FDC1025	1946-48	Special		
FDC1025	1946-48	Deluxe		
FDC1025	1946-48	Super Deluxe		
FDC1001	1949-51	All Models V8		
FDC1002	1954	Skyliner 239 CID - 4 Barrel		

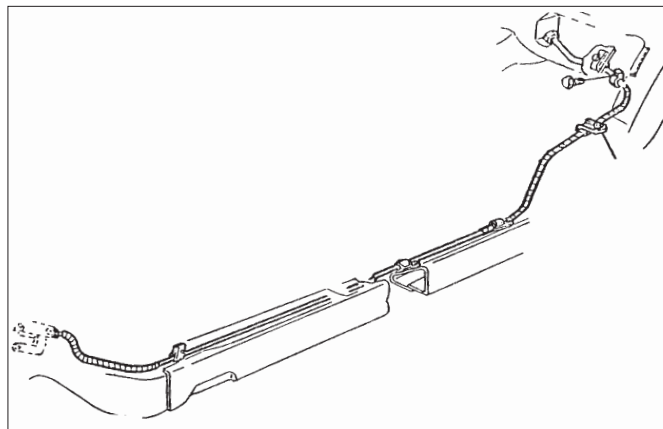
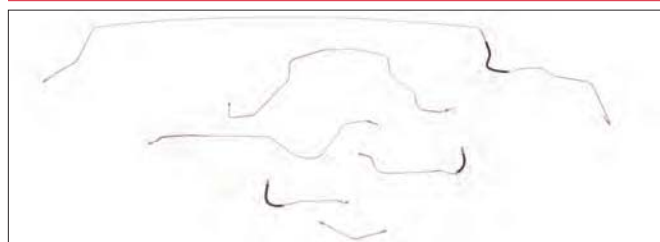

FDC1005	1954	All Models 239 CID - V8 - 2 Barrel
FDC1030	1955	Crown Victoria 272 CID 2 Barrel
FDC1028	1957	All Models 292 & 312 CID - 2 Barrel & 4 Barrel - Autolite
FDC1003	1960	Falcon 144 CID - 5/16" (1 Pc.)
FDC1004	1961-65	All Models 390/406/427 CID (2 Pc.) - w/ Inline Filter 2 - 4 Barrel or 3 - 2 Barrel
MUC1001	1964-65	Falcon Wagon 170 CID
MRC1003	1966	Fairlane 390 CID - 4 Barrel - Holley

### Fuel - Tank To Pump Line

Ford Early & Misc.

Part No.	Year	Description	O.E. Steel	Stainless Steel
FDF1001	1939-40	All Models		
FDF1002	1949-50	All Models (2 Pc.)		
FDF1002	1949-50	Wagon		
FDF1003	1951	Wagon		
FDF1015	1951	All Models (2 Pc.)		
FDF1004	1952-53	All Models (2 Pc.)		
FDF1005	1954	All Models		
FDF1014	1955-56	All Models		
FDF1006	1957	All Models With No Post		
FRF1001	1957	Retractable Fuel line		
FDF1007	1958	Wagon Fuel line		
FDF1018	1958	Edsel Hardtop - 124" WB		
FRF1014	1958	All Models With No Post Tank to Pump Line		
FRF1015	1958	All Models With Post Tank to Pump Line		
FDF1013	1959	Ranchero		
FRF1002	1959	Retractable Fuel line		
FDF1022	1960	Sunliner V8 - 352 - Convertible		
FDF1008	1960-62	Falcon 5/16" (1 Pc.)		
FDF1025	1963	Falcon Sprint - 2 Door Fastback - V8		
FDF1021	1964	Falcon Wagon V8		
FDF1024	1965	Falcon Wagon		
TNF1010	1967	Ranchero		
FDF1016	1968-69	Ranchero		
FRF1007	1968-69	Fairlane 6 Cylinder and Small Block V8 (5/16") - Convertible (2 Pc.)		
TNF1004	1968-69	Ranchero (2 Pc.)		
FDF1026	1971	Maverick Grabber		
FDF1010	1978-80	Fiesta		
FDF1023	1980	Pinto		

### Fuel - Return Line

Ford Early & Misc.

Part No.	Year	Description	O.E. Steel	Stainless Steel
FDR1002	1978-80	Fiesta		
FDR1001	1980	Pinto		

### Fuel - Vapor Line

Ford Early & Misc.

Part No.	Year	Description	O.E. Steel	Stainless Steel
FDV1002	1978-80	Fiesta		

# FORD

### Transmission Lines (Sold In Pairs) Ford Early & Misc.

Part No.	Year	Description	O.E. Steel	Stainless Steel
FDT1013	1957	All Models V8		
FDT1014	1958	Edsel 124" WB 3/8" Tubing		
FRT1017	1958-59	Full Size Medium Case - 2SP f Ford-O-Matic 3SP Cruise-O-Matic - Lines Enter From Rear 5/16" Tubing		
FDT1001	1966	Falcon 6 Cylinder - C-4		
FDT1004	1966	LTD 390 CID - C-6 Transmission		

### Transmission Modulator Line Ford Early & Misc.

Part No.	Year	Description	O.E. Steel	Stainless Steel
FDM1001	1966	LTD 390 CID		
MRM1003	1969-70	Comet 351 CID C6		

### Choke Tube Ford Early & Misc.

Part No.	Year	Description	O.E. Steel	Stainless Steel
FDK1001	1967	All Models 352 CID		
FDK1011	1973	All Models Choke Tube - (D3DZ-9819-B)		
FDK1012	1978	All Models Choke Tube - (D8BZ-9819-B)		

### Miscellaneous & Other Lines Ford Early & Misc.

Part No.	Year	Description	O.E. Steel	Stainless Steel
FD01013	1940	All Models		
FD01012	1946-48	All Models Hydraulic Lines		
FD01021	1947	All Models Oil Filter Lines (2 Pc.)		
FD01001	1948-51	Custom		
FD01002	1949-51	All Models 239 CID Flathead V8 - Oil Line Set		
FD01003	1950	All Models Convertible - Hydraulic Top Lines - Set (8 Pc.)		
FD01001	1950-53	Crestliner		
FD01001	1952-53	Customline		
FD01001	1952-53	Mainline		
FD01004	1954	All Models Fuel - Pump to Wiper - 239 CID - V8		
FD01005	1954	All Models Fuel - Pump to Manifold - 239 CID - V8		
FD01006	1954	All Models 239 CID - V8 - Distributor Vacuum Line		
FD01017	1954	Flat Head V8 Convertible Oil Filter Line		
FD01018	1955	Crown Victoria 272 CID 2 Barrel Carburetor - Distributor Vacuum Line		
FD01019	1955	Crown Victoria Fuel - Pump to Wiper 272 CID and 292 CID 2 Barrel Carburetor (2 Pc.)		
FD01007	1955-56	All Models Distributor Vacuum Line (2 Pc.)		
FD01015	1959	All Models 352 CID - 2 Barrel or 4 Barrel - Autolite - Distributor Vacuum Line (2 Pc.)		
FD01014	1964	Falcon Sprint 260 - Distributor Vacuum Line		
MVA1003	1964-66	All Models 260 & 289 CID Distributor Vacuum Line		
FD01020	1965	Falcon Wagon - Distributor Vacuum Line		
FD01008	1965-66	All Models 390/428 - Brake Booster Vacuum Line		
FDT1002	1965-66	All Models Transmission Case Vent Line		
GX01001	1965-66	LTD Brake Booster Vacuum Line - 390 CID - 4 Barrel		
GX01003	1965-66	LTD Brake Booster Vacuum - 428 CID		

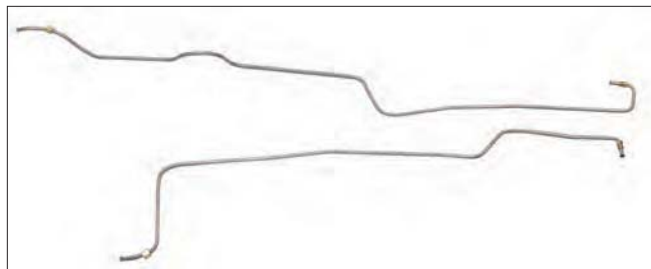

FDO1009	1978	All Models Vacuum Tube - (D8BZ-9816-B)
MU01010	1982	All Models 5.0 Liter Power Steering Line

## FAIRLANE

### Complete Brake Line Kit Fairlane

Part No.	Year	Description	O.E. Steel	Stainless Steel
FR1001	1957			
FR1002	1957	Retractable		
FR1003	1958	Retractable		
FR1004	1959	Retractable		
FR1007	1962-65	Standard Drum		
FR1008	1962-65	Power Drum		
FR1010	1966	Power Drum All Except 390 CID		
FR1011	1966	Power Drum 390 CID - Only		
FR1013	1967	Standard Drum		
FR1014	1967	Power Drum		
FR1015	1967	Power Disc 2-Piece Front to Rear		
FR1019	1967	Power Disc - 427 CID 2-Piece Front to Rear		
FR1016	1968-69	Standard Drum 8" Axle		
FR1018	1968-69	Power Disc - 8" Axle		
FR1020	1968-69	Power Disc - 9" Axle		
FR1021	1968-69	Standard Drum 9" Axle		

### Caliper Inlet Lines & Transfer Tubes (Sold in Pairs) Fairlane

Part No.	Year	Description	O.E. Steel	Stainless Steel
MUD1001	1965-67	Caliper Transfer Tubes		

### Fuel - Pump To Carburetor Line Fairlane

Part No.	Year	Description	O.E. Steel	Stainless Steel
FRC1001	1957	312 CID - 4 Barrel - Carter		
FRC1002	1957			
FRC1003	1957-58	352 CID - 4 Barrel - Carter		
FRC1006	1963	221 CID - V8 - 2 Barrel		
MRC1003	1966	390 CID - 4 Barrel - Holley		

### Fuel - Tank To Pump Line Fairlane

Part No.	Year	Description	O.E. Steel	Stainless Steel
FRF1001	1957			
FRF1002	1959			
FRF1003	1963-65	5/16" (1 Pc.)		
FRF1004	1963-65	3/8"		
FRF1005	1966	6 Cylinder 5/16" (1 Pc.)		
FRF1006	1967	6 Cylinder - 5/16" (2 Pc.)		
FRF1012	1967	Hardtop - Big Block - 3/8" (2 Pc.)		
FRF1009	1968-69	6 Cylinder - 5/16" (2 Pc.)		

### Transmission Lines (Sold In Pairs) Fairlane

Part No.	Year	Description	O.E. Steel	Stainless Steel
FRT1002	1957			
FRT1003	1963-64	V8 - 289 CID - C-4		
FRT1004	1966	V8 - C-4		

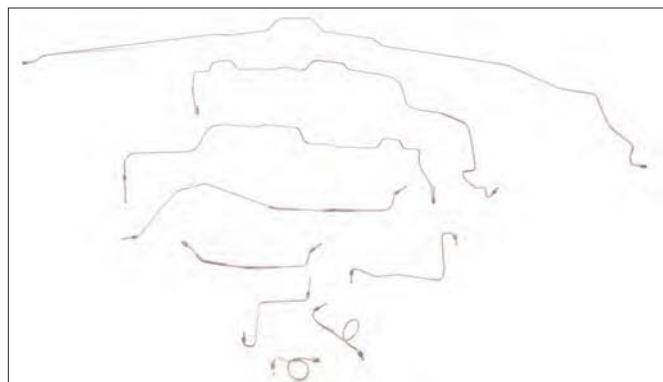

## FORD

FRT1011	1966	V8 - C-6
FRT1018	1967	390 CID C6 Transmission
FRT1005	1967-69	V8 - C-6

Transmission Modulator Line			Fairlane	
Part No.	Year	Description	O.E. Steel	Stainless Steel
FRM1001	1964	289 CID 2 Barrel Carburetor Cruise-o-matic Transmission		
FRM1002	1966	390 CID C6 Transmission		
MUM1005	1967-68	V8 - C4		

Choke Tube			Fairlane	
Part No.	Year	Description	O.E. Steel	Stainless Steel
FRK1001	1964	289 CID (2 Pc.)		

Miscellaneous & Other Lines			Fairlane	
Part No.	Year	Description	O.E. Steel	Stainless Steel
FR01001	1957	Vacuum Line from Fuel Pump To Carburetor		
FR01002	1957	Retractable - Vacuum Line - Fuel Pump to Wiper Motor - 312 CID - 4 Barrel		
FR01003	1957	Retractable 312 CID - 4 Barrel - Distributor Vacuum Line		
FR01007	1957	Distributor Vacuum Line 292 CID - 2 Barrel		
FR01008	1957	Retractable 312 CID - 4 Barrel - Holley - Distributor Vacuum Line		
FR01004	1957-59	Retractable 352 CID - Distributor Vacuum Line		
FR01009	1958	Retractable - Power Steering Lines (2 Pc.)		
FR01006	1959	Retractable Power - Steering CrossOver Line		
FR01010	1964-66	289 CID - Distributor Vacuum Line		

## GALAXIE

Complete Brake Line Kit			Galaxie	
Part No.	Year	Description	O.E. Steel	Stainless Steel
GX1014	1960	Standard Brake		
GX1001	1962	Standard Drum		
GX1019	1963	427 CID - 406 CID - 390 CID Hi-Performance - Right Front Under Radiator		
GX1003	1963-64	Standard Drum Non-Big Block		
GX1009	1963-64	Power Drum		
GX1005	1965	Standard Drum		
GX1006	1965	Power Drum		

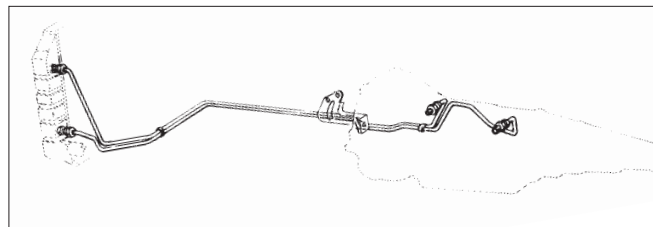

GX1007	1965	Standard Disc
GX1017	1965	Power Disc
GX1010	1966	Standard Disc
GX1020	1966	Standard Drum
GX1021	1966	Power Drum
GX1022	1966	Power Disc
GX1018	1967	Power Disc
GX1011	1967-68	Power Drum
GX1015	1967-68	Standard Drum
GX1023	1968	Power Disc
GX1016	1969	Power Disc
GX1013	1971-72	Power Disc - w/9" Axle

Caliper Inlet Lines & Transfer Tubes (Sold in Pairs)			Galaxie	
Part No.	Year	Description	O.E. Steel	Stainless Steel
GXD1001	1965-66	Disc Brake - Inlet Line		
TBD1002	1965-67	Caliper Transfer Tube		
GXD1003	1967	Disc Brake - Inlet Line		

Fuel - Pump To Carburetor Line			Galaxie	
Part No.	Year	Description	O.E. Steel	Stainless Steel
GXC1007	1963-64	500 XL 352 CID - 2 Barrel		
GXC1002	1965-66	390/428 CID - 2 Barrel & 4 Barrel - Autolite 4100 Carburetor		
MUC1007	1966	289 CID - 4 Barrel Carburetor		
MUC1007	1966-69	289 CID - 2 Barrel Carburetor		
MUC1009	1967	390 CID - 2 Barrel and 4 Barrel - California Emissions		

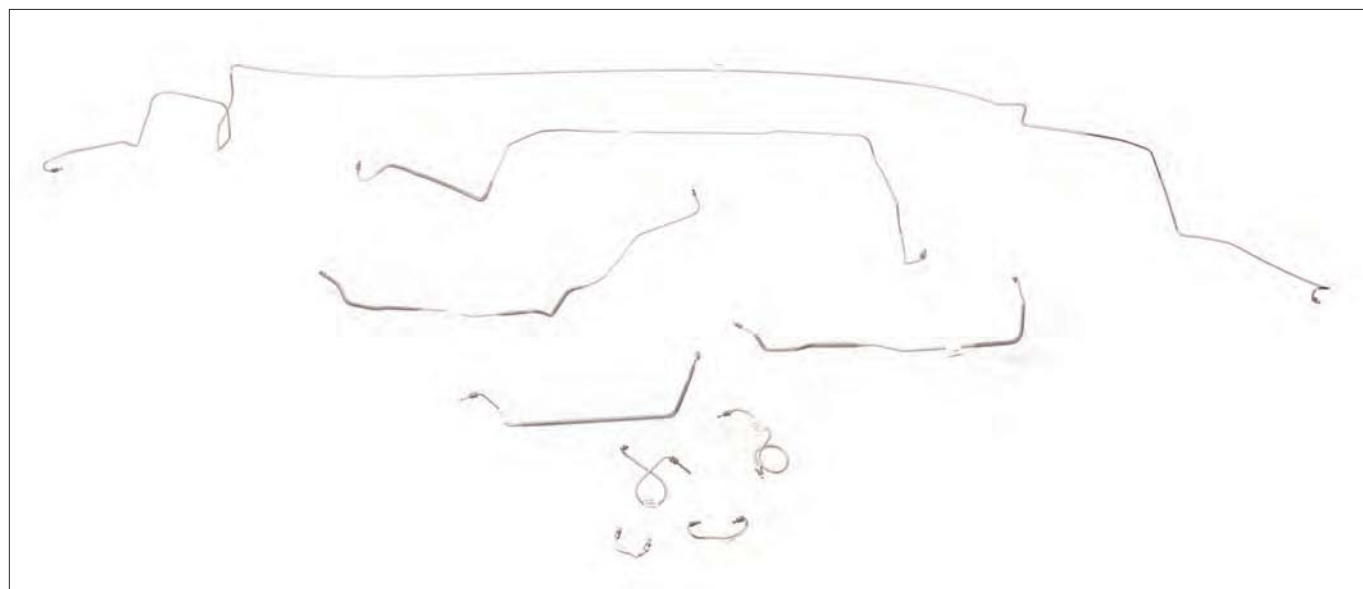

# FORD

## Fuel - Tank To Pump Line Galaxie

Part No.	Year	Description	O.E. Steel	Stainless Steel
GXF1010	1961	Starliner		
GXF1001	1961-62	5/16"		
GXF1002	1961-62	3/8"		
GXF1004	1963	3/8" - 427 CID (1963-1/2)		
GXF1003	1963-64	5/16"		
GXF1006	1965	3/8" - 427 CID R Model		
GXF1005	1965-67	4 Door Sedan - 5/16" (1 Pc.)		
GXF1007	1967	(1 Pc.)		
GXF1009	1968	5/16" - (1 Pc.)		
GXF1008	1969	Convertible - 429 CID		

## Fuel - Vapor Line Galaxie

Part No.	Year	Description	O.E. Steel	Stainless Steel
GXV1001	1972			

## Transmission Lines (Sold In Pairs) Galaxie

Part No.	Year	Description	O.E. Steel	Stainless Steel
GXT1005	1960	MX		
GXT1006	1960	Cruise-O-Matic - 352 CID		
GXT1003	1962-63	C-4		
GXT1010	1962-63	MX (Galaxie 500 XL)		
GXT1011	1964	289 CID - C-4		
GXT1001	1964-65	MX		
GXT1004	1966	C-4 (Early 1966)		
GXT1012	1966	C-6		
GXT1002	1966-67	C-4 (Late 1966)		
GXT1008	1967	C-6		
GXT1013	1967	C-4		
GXT1014	1971			

## Transmission Modulator Line Galaxie

Part No.	Year	Description	O.E. Steel	Stainless Steel
GXM1001	1963-64	Transmission Modulator Line - 352 CID		
GXM1002	1965-66	390 CID		
MRM1002	1967-68	2 Barrel - 390 CID		

## Choke Tube Galaxie

Part No.	Year	Description	O.E. Steel	Stainless Steel
LNK1001	1968-69	Choke Tube Set - 429 CID - 4 Barrel		

## Miscellaneous & Other Lines Galaxie

Part No.	Year	Description	O.E. Steel	Stainless Steel
GX01006	1960	Power Steering Return Lines & Power Steering Cylinder Lines (4 Pc.)		
GX01007	1963-64	352 CID 2 Barrel Distributor Vacuum Line		
TBA1006	1964-66	Distributor Vacuum Line - 390 CID		
GX01008	1965	LTD Midland Booster 390 CID 4 Barrel Carburetor - Brake Booster Vacuum Line		
GX01001	1965-66	Brake Booster Vacuum Line - 390 CID - 4 Barrel		
GX01002	1965-66	390 CID - Holley Carburetor - Distributor Vacuum Line		

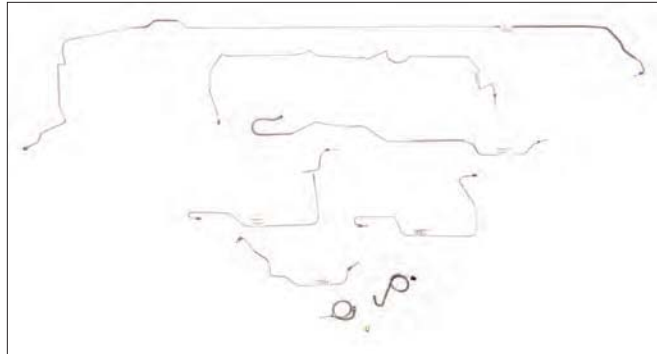

## MUSTANG

### Complete Conversion Brake Line Kit Mustang

Part No.	Year	Description	O.E. Steel	Stainless Steel
CUST/MUS	1964-73	Custom Bent Disc Brake Conversion Kit Brake Line Kit. Call with your specifications and components eg. SSBC, BAER, MP, CPP, etc.		

### Floor Pan Reinforcement Plate Mustang

Part No.	Year	Description	O.E. Steel	Stainless Steel
6511161-L	1965	Floor Pan, Left - Dual Exhaust Floor Pan Reinforcement Plates		
6511161-R	1965	Floor Pan, Right - Dual Exhaust Floor Pan Reinforcement Plates		
FPEH-65	1965	Dual Exhaust Floor Pan Set R&L, 2 Pans, 2 Exhaust Hangers and 2 Stud Brackets ** Sold as a 6 Pc. Set		
6511162-L	1966	Floor Pan, Left, With Seat Belt Access Holes - Dual Exhaust Floor Pan Reinforcement Plates		
6511162-R	1966	Floor Pan, Right, With Seat Belt Access Holes - Dual Exhaust Floor Pan Reinforcement Plates		
FPEH-66	1966	Dual Exhaust Floor Pan Set R&L, 2 Pans, 2 Exhaust Hangers and 2 Stud Brackets ** Sold as a 6 Pc. Set		
6511163-L	1967-69	Floor Pan, Left, With Seat Belt Access Holes - Dual Exhaust Floor Pan Reinforcement Plates		
6511163-R	1967-69	Floor Pan, Right, With Seat Belt Access Holes - Dual Exhaust Floor Pan Reinforcement Plates		
FPEH-67	1967-69	Dual Exhaust Floor Pan Set R&L, 2 Pans, 2 Exhaust Hangers and 2 Stud Brackets ** Sold as a 6 Pc. Set		

### Complete Brake Line Kit Mustang

Part No.	Year	Description	O.E. Steel	Stainless Steel
MU1001	1964-65	Standard Drum - 6 Cylinder		
MU1002	1964-65	Power Drum - 6 Cylinder		
MU1003	1964-65	Standard Drum - V8 Factory Single Exhaust		
MU1067	1964-65	Standard Drum - V8 Factory Dual Exhaust		
MU1068	1964-65	Power Drum - V8 - Factory Dual Exhaust		
MU1005	1965	Standard Disc - V8 - 8" and 9" Axle - Factory Dual Exhaust		
MU1057	1965-66	Standard Disc - V8 - 8" and 9" Axle - Factory Single Exhaust		
MU1007	1966	Standard Drum - 6 Cylinder		
MU1008	1966	Power Drum - 6 Cylinder		
MU1009	1966	Standard Drum - V8 - Factory Single Exhaust		
MU1010	1966	Power Drum - V8 - Factory Single Exhaust		
MU1065	1966	Standard Drum - Factory Dual Exhaust		
MU1066	1966	Power Drum - Factory Dual Exhaust		
MU1081	1966	Standard Disc - V8 - 8" and 9" Axle - Factory Dual Exhaust		
MU1011	1967	Standard Drum - 6 Cylinder (Built Before Feb. 1967) - Right Front and Front to Rear Route Over Steering Box		
MU1012	1967	Power Drum - 6 Cylinder (Built Before Feb. 1967) - Right Front and Front to Rear Route Over Steering Box		
MU1013	1967	Standard Drum - V8 - 8" and 9" Axle (Built Before Feb. 1967) - Right Front and Front to Rear Route Over Steering Box		
MU1014	1967	Power Drum - V8 - 8" and 9" Axle (Built Before Feb. 1967) - Right Front and Front to Rear Route Over Steering Box		
MU1015	1967	Power Disc - V8 - 8" and 9" Axle (Built Before Feb. 1967) - Right Front and Front to Rear Route Over Steering Box		

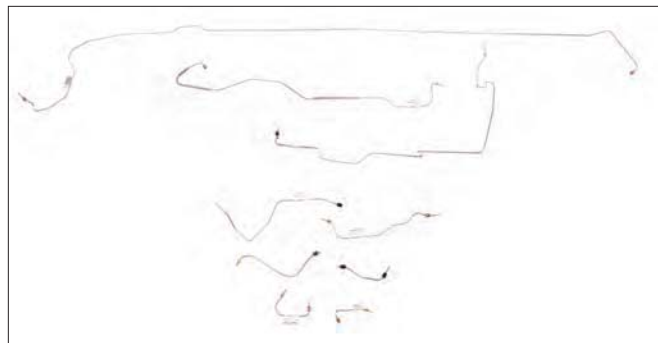

# FORD

MU1016	1967	Power Disc - V8 - 8" and 9" Axle (Built After Feb. 1967) - Right Front and Front to Rear Routes Under Steering Box
MU1051	1967	Standard Drum - 6 Cylinder (Built After Feb. 1967) - Right Front and Front to Rear Routes Under Steering Box
MU1052	1967	Power Drum - 6 Cylinder (Built After Feb. 1967) - Right Front and Front to Rear Routes Under Steering Box
MU1053	1967	Standard Drum - V8 - 8" and 9" Axle (Built After Feb. 1967) - Right Front and Front to Rear Routes Under Steering Box
MU1055	1967	Power Drum - V8 - 8" and 9" Axle (Built After Feb. 1967) - Right Front and Front to Rear Routes Under Steering Box
MU1017	1968-69	Standard Drum - 6 Cylinder
MU1018	1968-69	Power Drum - 6 Cylinder
MU1019	1968-69	Standard Drum - V8 - 8" Axle
MU1020	1968-69	Standard Drum - V8 - 9" Axle - 31 Spline
MU1021	1968-69	Power Drum - V8 - 8" Axle
MU1022	1968-69	Power Drum - V8 - 9" Axle - 28 Spline
MU1023	1968-69	Power Drum - V8 - 9" Axle - 31 Spline
MU1024	1968-69	Power Disc - V8 - 8" Axle
MU1025	1968-69	Power Disc - V8 - 9" Axle - 28 Spline
MU1026	1968-69	Power Disc - V8 - 9" Axle - 31 Spline
MU1056	1968-69	Standard Drum - V8 - 9" Axle - 28 Spline
MU1027	1969	Boss 429 Only
MU1028	1970	Standard Drum - All
MU1029	1970	Power Drum - All
MU1030	1970	Power Disc - All
MU1031	1970	Boss 429 Only
MU1050	1971	Power Disc - V8 - 9" Axle - with Factory Rear Swaybar
MU1036	1971-72	Power Disc - V8 - 9" Axle (Built before July 1972)
MU1049	1971-72	Power Disc - 6 Cylinder and V8 - 8" Axle (Built before July 1972)
MU1037	1971-73	Standard Drum - 6 Cylinder and V8 - 8" Axle
MU1038	1971-73	Standard Drum - V8 - 9" Axle
MU1039	1971-73	Power Drum - 6 Cylinder and V8 - 8" Axle
MU1040	1971-73	Power Drum - V8 - 9" Axle
MU1041	1972-73	Power Disc - 6 Cylinder and V8 - 8" Axle (Built After July 1972)
MU1042	1972-73	Power Disc - V8 - 9" Axle - (Built After July 1972)
MU1043	1974-78	Power Disc
MU1058	1979	Power Disc
MU1071	1979	4 Cylinder - Standard Disc
MU1076	1980	Standard Disc
MU1044	1980-81	Power Disc
MU1045	1982-84	Power Disc
MU1072	1984	SVO
MU1046	1985	SVO (Early 1985) - 3/16" Axle Lines (4 Wheel Disc)
MU1047	1985-86	SVO (Late 1985-1986) - 1/4" Axle Lines (4 Wheel Disc)
MU1061	1985-86	Power Disc - Non V8 Motor (7.5 Axle)
MU1077	1985-86	Power Disc - V8 Motor With 7.5 Axle
MU1054	1986	V8 - Power Disc - 8.8 Axle
MU1048	1987-93	Power Disc 8 Cylinder
MU1083	1987-93	Power Disc 4 Cylinder
MU1064	1993	Cobra Only Factory Rear Disc
MU1070	1994-95	V6 - Non ABS
MU1078	1994-95	With 8.8 Axle - With ABS
MU1085	1994-95	With 7.5 Axle - With ABS

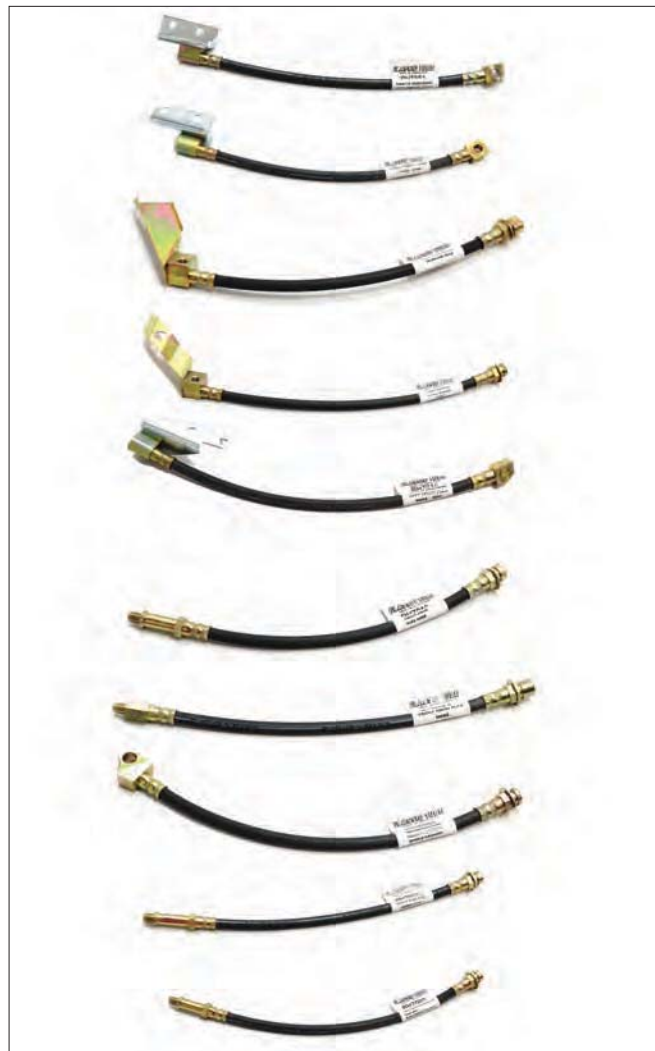

MU1086	1994-95	With 8.8 Axle - Non ABS
MU1087	1994-95	Cobra With ABS
MU1084	1996	Non ABS
MU1069	1997	Cobra With ABS
MU1074	1998	V6 - Non ABS
MU1075	1999-04	With ABS

**NOTE: FOR STOPFLEX D.O.T. STAINLESS BRAIDED BRAKE HOSES, SEE PAGE 107.**

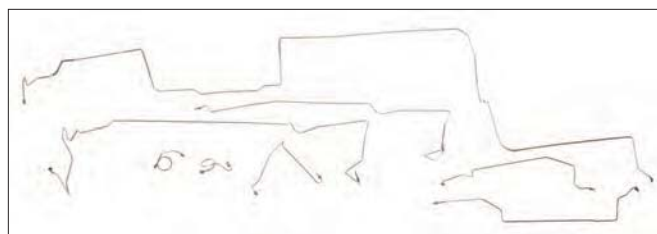

Rubber Brake Hose			Mustang	
Part No.	Year	Description	O.E. Steel	Stainless Steel
RH7009	1964-65	Front Drum Flex Hose - Built before Aug.1965		
RH7003	1965-66	Rear Flex Hose - Single Exhaust		
RH7007	1965-66	Rear Flex Hose - Dual Exhaust Hi-Po		
RH7001	1965-66	Front Disc Flex Hose - 3/8" Inlet		
RH7010	1965-66	Front Drum Flex Hose - Built before August 1965		
RH7002	1966-67	Front Disc Flex Hose - 7/16" Inlet		
RH7006	1967-69	Rear Flex Hose - 28 Spline		
RH7008	1967-70	Front Drum Flex Hose		

# FORD

Cont. from previous page

RH7011	1968-69	Rear Flex Hose - 31 Spline - Big Block
RH7004	1968-70	Left Front Flex Hose - Disc
RH7005	1968-70	Right Front Flex Hose - Disc
RH7013	1970	Rear Flex Hose
RH7012	1971-73	Front Drum Flex Hose
RH7014	1971-73	Rear Flex Hose
RH7015	1971-73	Left Front Flex Hose - Disc
RH7016	1971-73	Right Front Flex Hose - Disc

Caliper Inlet Lines & Transfer Tubes (Sold in Pairs)			Mustang	
Part No.	Year	Description	O.E. Steel	Stainless Steel
MUD1001	1965-67	4 Piston - Kelsey Hayes - Disc Brake Transfer Tube		

Hydraulic Clutch Line			Mustang	
Part No.	Year	Description	O.E. Steel	Stainless Steel
MUH1001	2005-09	V8 4.6 Liter 5 Speed		
MUH1002	2007-09	5.4 Liter 6 Speed		

Fuel - Pump To Carburetor Line			Mustang	
Part No.	Year	Description	O.E. Steel	Stainless Steel
MUC1001	1964-65	170 CID		
MUC1002	1964-65	260 CID - V8-2 Barrel and 4 Barrel		
MUC1003	1964-65	289 CID - V8-2 Barrel and 4 Barrel		
MUB1001	1964-67	Holley - 715 CFM - Center Pivot - Bowl to Bowl Transfer Tube		
MUC1004	1965	289 CID - Carburetor Line - with Holley 715 CFM		
MUC1005	1965	427 Cammer (AFX - etc.) (2 Pc.)		
MUC1026	1965-66	Custom - with Holley - 600 CFM - Left Side Outlet		
MUC1007	1966	289 CID - 2 Barrel and 4 Barrel		
MUC1008	1966-67	289 CID - with 715 CFM - Holley (Shelby)		
MUC1007	1966-68	289 CID - 2 Barrel and 4 Barrel		
MUC1006	1966-70	6 Cylinder - 200 CID - 250 CID - Non-California Emissions		
MUC1031	1966-70	6 Cylinder- 200 CID and 250 CID - California Emissions		
MUC1009	1967	390 CID - 2 Barrel and 4 Barrel - California Emissions		
MUC1011	1967	428 CID - (2) 4 Barrel		
MUC1032	1967	390 CID - 2 Barrel California Emissions		
MUC1013	1967-68	GT350 - 302 CID - 4 Barrel		
MUB1002	1968-70	Holley - 735 / 780 CFM - 428 CID / 302 CID Boss - Bowl to Bowl Transfer Tube		
MUC1012	1968-70	302 CID and 351W - 2 Barrel		
MUC1014	1968-70	351W 4 Barrel		
MUC1015	1968-70	428 & 390 CID - 4 Barrel		
MUC1016	1969-70	Boss 302 CID		
MUC1017	1969-70	429 CID		
MUC1018	1970-73	351C - 2 Barrel		
MUC1019	1970-73	Boss 351 and 351 Cleveland - 4 Barrel Carburetor		

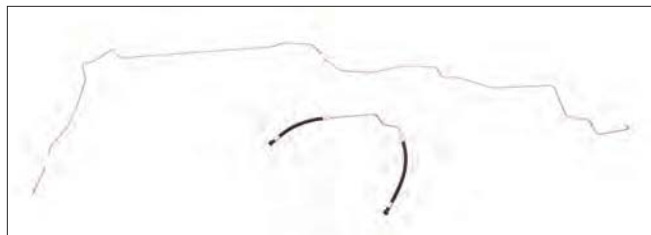

MUC1020	1970-73	429 SCJ - Holley
MUC1030	1970-73	351C 2 Barrel - AC Factory
MUC1022	1971	429 CID CJ - 4 Barrel - Quadrajel (Only)
MUC1027	1971-73	302 CID - 2 Barrel
MUC1023	1974-76	302 CID
MUC1024	1977-78	302 CID
MUC1034	1979	302 CID
MUC1033	1982	302 CID - 2 Barrel Carburetor - With Air Conditioning
MUC1029	1983	V6 - 3.6 Liter
MUC1028	1983-84	GT - 302 CID - 4 Barrel - 5.0 Liter
MUC1025	1985	GT - 302 CID - 4 Barrel - Holley/Autolite Carburetor

**NOTE: BRAKE AND FUEL LINE CLIP KITS CONCOURSE CORRECT, SEE PAGE 104.**

Fuel - Tank To Pump Line			Mustang	
Part No.	Year	Description	O.E. Steel	Stainless Steel
MUF1024	1964	6 Cylinder (1964-1/2)		
MUF1025	1964	V8 (1964-1/2)		
MUF1002	1964-66	V8 - 5/16"		
MUF1001	1965-66	6 Cylinder		
MUF1003	1966	V8 - 3/8" (Race)		
MUF1005	1967	V8-Early - 5/16" (1 Pc.) - Runs Down Tunnel		
MUF1023	1967	Early - 6 Cylinder (1 Pc.)		
MUF1006	1967-68	V8 (Late 1967 & All 1968) 5/16" (2 Pc.) - Runs Down Rocker		
MUF1007	1967-68	V8 (Late 1967 & All 1968) 3/8" (2 Pc.) Runs Down Rocker		
MUF1004	1967-70	6 Cylinder - (2 Pc.)		
MUF1013	1967-70	With 6 Cylinder California emissions 5/16" (2 Pc.)		
MUF1022	1967-70	6 Cylinder California emission - 3/8"		
MUF1008	1968	V8-428CJ - Stagger Rear Shock		
MUF1009	1969-70	V8 - 3/8" (2 Pc.)		
MUF1010	1969-70	V8 - 3/8" (2 Pc.) with Factory Rear Sway Bar, not Boss 429		
MUF1035	1970	6 Cylinder California emission - 3/8"		
MUF1012	1971-73	V8 - 3/8" (2 Pc.)		

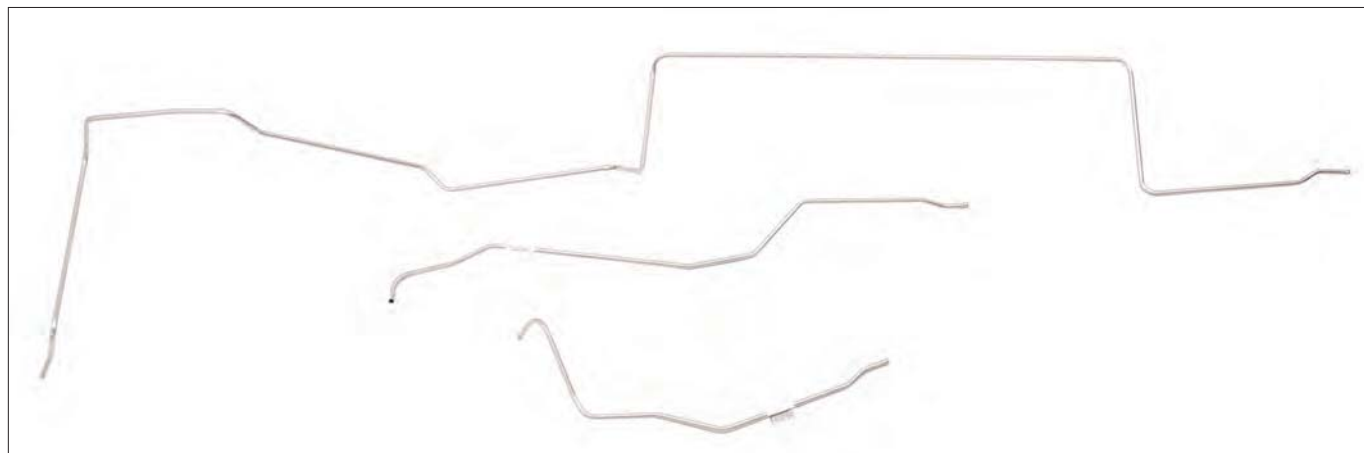

## FORD

MUF1033	1974-76
MUF1029	1977-78 V6 and V8 - 5/16" (1 Pc.)
MUF1030	1982-83 GT 5.0
MUF1019	1983-86 V6 - 5/16" (2 Pc.)
MUF1018	1984 GT - V8 - 5/16"
MUF1036	1985 GT - V8 - 5/16"
MUF1021	1986-93 V8 - 5/16" With Factory Hoses and Connections
MUF1026	1987-93 Fuel - Injected 2.3 Liter
MUF1027	1994-95 V8
MUF1034	1996-98 V6 and V8 Motors

### Fuel - Return Line Mustang

Part No.	Year	Description	O.E. Steel	Stainless Steel
MUR1001	1971	429 CID Only		
MUR1023	1974-76			
MUR1003	1977-78	V6 and V8		
MUR1022	1982	GT 5.0		
MUR1018	1984	1/4" GT		
MUR1025	1985	GT - V8 - 5/16"		
MUR1017	1986-93	V8 - 1/4" With Factory Hoses & Connections		
MUR1021	1987-93	Fuel - Injected 2.3 Liter		
MUR1005	1994	V6		
MUR1024	1996-98	V6 and V8 Motors		

### Fuel - Vapor Line Mustang

Part No.	Year	Description	O.E. Steel	Stainless Steel
MUV1001	1970	V8 - With California Emissions (5/16")		
MUV1002	1971-73	V8 - 5/16" (1 Pc.)		
MUV1003	1977-78	1/4" (1 Pc.)		
MUV1018	1986-93	5.0 Liter - V8 - 1/4"		
MUV1004	1994	V6		
MUV1021	1999-04			

### Fuel - Vent Line Mustang

Part No.	Year	Description	O.E. Steel	Stainless Steel
MUV1011	1969-70	Trunk Mount		

### Transmission Lines (Sold In Pairs) Mustang

Part No.	Year	Description	O.E. Steel	Stainless Steel
MUT1001	1964-65	C-4 - 6 Cylinder		
MUT1002	1964-65	C-4 - V8		
MUT1024	1965	Conversion From C-4 Transmission to AOD Transmission With Small Block Engines		
MUT1003	1966	C-4 - 6 Cylinder		
MUT1004	1966	C-4 - V8		



MUT1022	1966	Conversion From C-4 Transmission to AOD Transmission With Small Block Engines		
MUT1007	1967-68	C-6 - V8 - Early 1968		
MUT1005	1967-70	C-4 - 6 Cylinder		
MUT1006	1967-70	C-4 - V8		
MUT1023	1967-70	Conversion From C-4 Transmission to AOD Transmission With Small Block Engines		
MUT1008	1968-70	C-6 - V8 - Late 1968		
MUT1009	1969-70	351W - FMX - V8 - Heavy Duty Cooling		
MUT1017	1970	351C - FMX - V8		
MUT1018	1970	C-6 - Big Block - Early 1970		
MUT1019	1970	C-6 - Big Block - Late 1970 - 428 CJ		
MUT1010	1971-73	C-4 - V8		
MUT1011	1971-73	C-6 - V8		
MUT1012	1971-73	FMX - V8		
MUT1013	1974-75	171 CID-6 Cylinder with C-4 without HD cooler		
MUT1025	1975	With 302 CID Engine		
MUT1016	1976-78	C-4 - V8		
MUT1014	1980	C-4 - V8		
MUT1020	1983	All Models		
MUT1021	1984-93	5.0 Liter AOD Transmission		

### Transmission Modulator Line Mustang

Part No.	Year	Description	O.E. Steel	Stainless Steel
MUM1001	1964-65	6 Cylinder - (1 Pc.) with Fitting		
MUM1002	1964-65	289 CID - V8 - C4 with Fitting		
MUM1003	1965-66	V8 - C4 - Hose on Both Ends		
MUM1004	1966-68	6 Cylinder (2 Pc.)		
MUM1011	1966-69	Intake Line for Modulator-3/8"		
MUM1005	1967-69	V8 - C4		
MUM1006	1967-70	V8 - C6		
MUM1012	1969-70	351 CID - FMX		
MUM1014	1971	V8 - 429 CID - C6 Automatic Transmission		
MUM1007	1971-73	V8 - C4		
MUM1008	1971-73	V8 - C6		
MUM1013	1972-73	FMX Transmission		
MUM1015	1973	351 C - 4 Barrel - C-6 Transmission		
MUM1009	1974-78	V8		

### Transmission Vent Line Mustang

Part No.	Year	Description	O.E. Steel	Stainless Steel
MUM1010	1964-78	C4-Transmission Vent Tube - 5/16"		

# FORD

## Choke Tube Mustang

Part No.	Year	Description	O.E. Steel	Stainless Steel
MUK1001	1964-66	260 CID - 289 CID - 2 Barrel or 4 Barrel (2 Pc.)		
MUK1002	1964-69	170 - 200 CID 6 Cylinder (1 Pc.)		
MUK1016	1967	6 Cylinder Carter YF Carburetor California Emissions		
MUK1003	1967-68	390 CID - 4 Barrel (2 Pc.)		
MUK1001	1967-73	289 CID - 302 CID - 2 Barrel (2 Pc.)		
MUK1005	1968	302 - 4 Barrel (2 Pc.)		
MUK1017	1968-69	Shelby Small Block Motor With Holley Carburetor and Aluminum Intake (2 Pc.)		
MUK1006	1968-69	428 CID - 4 Barrel		
MUK1018	1969	R Code - 428 CID Motor Mid-Feb. 1969 to 1969 end of production		
MUK1008	1969-70	351W - 2 Barrel - Enter Through Bottom of Choke Housing (2 Pc.)		
MUK1009	1969-70	351W - 4 Barrel - Enter Through Side of Choke Housing (2 Pc.)		
MUK1011	1970-73	351C - 2 Barrel (2 Pc.)		
MUK1012	1970-73	351C - 4 Barrel (2 Pc.)		
MUK1013	1971	429 Quadrajet		
MUK1014	1971	429 SCJ		
MUK1015	1983-84	302 CID 4 Barrel Carburetor ( 2 Pc.)		

## Miscellaneous & Other Lines Mustang

Part No.	Year	Description	O.E. Steel	Stainless Steel
MUA1001	1964-65	Distributor Vacuum Line - 6 Cylinder - 170/200 CID		
MUO1001	1964-65	Brake Booster Vacuum Lines - 260 CID & 289 CID - V8		
MUA1003	1964-66	Distributor Vacuum Line - 260 & 289 CID (Except Holley)		
MUA1004	1966	Distributor Vacuum Line - 289 CID California Emissions With Anti-Backfire Valve		
MUO1002	1966-68	Brake Booster Vacuum Lines - 289 CID - V8		
MUA1002	1966-68	6 Cylinder- 200 CID Distributor Vacuum Line		
MUO1008	1967	Brake Booster Vacuum Lines - 390 CID - 4 Barrel - Automatic Transmission		
MUO1004	1968	Brake Booster Vacuum Line - 302 CID - V8		
MUO1005	1968-69	Brake Booster Vacuum Lines - 428 CID (Except Shelby)		
MUO1007	1969-70	Brake Booster Vacuum Line - 351W		
MUO1011	1974-77	Rack and Pinion Lines (2 Pc.)		
MUO1013	1983	Carburetor Fuel Bowl to Canister Line - 5.0 Liter GT With A/C Holley Carburetor		
MUO1012	1986	Turbo Oil Separator Line - SV0		

## THUNDERBIRD

## Complete Brake Line Kit Thunderbird

Part No.	Year	Description	O.E. Steel	Stainless Steel
TB1001	1955	Standard Brake Manual Transmission		
TB1002	1955	Power Brake		
TB1019	1955	Standard Brake Automatic Transmission		
TB1003	1956	Standard Brake Manual Transmission		
TB1004	1956	Power Brake		
TB1020	1956	Standard Brake Automatic Transmission		
TB1005	1957	Standard Brake Manual Transmission		
TB1006	1957	Power Brake		
TB1021	1957	Standard Brake Automatic Transmission		
TB1007	1958	Standard Brake		
TB1008	1958	Power Brake-Booster - Under Dash		
TB1009	1959-60	Standard Brake		
TB1010	1959-60	Power Brake-Booster on Firewall		
TB1022	1959-60	Power Brake - Booster Under Dash		
TB1011	1961-62	Power Brake		
TB1012	1963	Power Brake		
TB1013	1964	Power Brake		
TB1014	1965-66	Power Disc		
TBD1001	1965-67	Disc Brake - 4 Piston - Kelsey-Hayes Caliper- Cross Over Tubes		

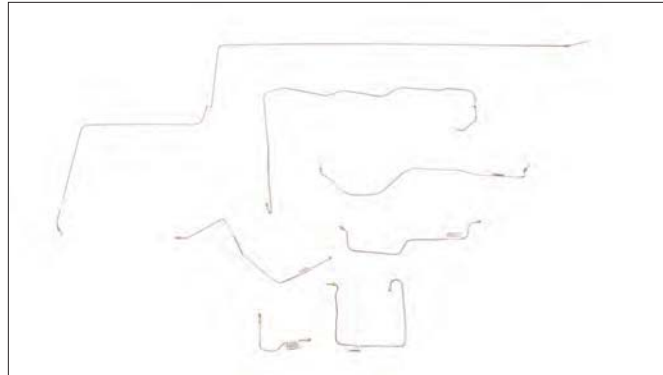

TB1024	1967-69	4 Door		
TB1017	1970-71	Power Disc		
TB1015	1977-79	Power Disc		
TB1018	1983-86	Coupe - Turbo		
TB1026	1983-86	With V8 Motors		
TB1023	1987-88	Non V8 Motors		
TB1025	1987-88	With V8 Motors		

## Fuel - Pump To Carburetor Line Thunderbird

Part No.	Year	Description	O.E. Steel	Stainless Steel
TBC1001	1955	(2 Pc.)		
TBC1012	1956	(2 Pc.)		
TBC1002	1957	312 CID - "E" - 2-4V (4 Pc.)		
TBC1013	1957	312 CID (2 Pc.)		
TBC1003	1958-60	352 CID (1 Pc.) w/Air Conditioning		
TBC1009	1958-60	352 CID (1 Pc.) without Air Conditioning		
TBC1004	1961	390 CID (2 Pc.)		
TBC1005	1962-63	390 CID (1 Pc.)		
TBC1006	1964	390 CID (1 Pc.)		
TBC1007	1965-66	390 - 4 Barrel - Holley (Factory)		
TBC1010	1965-66	390 - 4 Barrel - Holley (Factory)		
TBC1014	1970	429 CID - 4 Barrel - Autolite Carburetor		

## Fuel - Tank To Pump Line Thunderbird

Part No.	Year	Description	O.E. Steel	Stainless Steel
TBF1001	1955-57	5/16" (2 Pc.)		
TBF1002	1956-57	F Code - 5/16" (2 Pc.) Supercharged		
TBF1010	1957	5/16" (2 Pc.) Non Supercharged		
TBF1003	1958-60	5/16" (1 Pc.)		
TBF1004	1961	5/16" (2 Pc.)		
TBF1005	1962	5/16" (2 Pc.)		
TBF1007	1964	3/8" (2 Pc.)		
TBF1008	1965-66	3/8" (2 Pc.)		
TBF1009	1970	429 CID - 4 Barrel - Autolite Carburetor - 3/8"		

## Transmission Lines (Sold In Pairs) Thunderbird

Part No.	Year	Description	O.E. Steel	Stainless Steel
TBT1003	1958-59	With Swagged Hoses as OE		
TBT1010	1959	430 CID - Large Case Transmission		
TBT1005	1961	MX		
TBT1006	1962-63	MX		
TBT1009	1968-69	C-6 - 429 CID		

## Transmission Modulator Line Thunderbird

Part No.	Year	Description	O.E. Steel	Stainless Steel
TBM1003	1958-64	MX Transmission Modulator Line		
TBM1005	1958-64	MX Transmission		
TBM1001	1960	Modulator Line		
TBM1004	1966	C-6 Modulator Line		

## FORD

Choke Tube			Thunderbird	
Part No.	Year	Description	O.E. Steel	Stainless Steel
TBK1001	1955	Inlet Tube		
TBK1002	1956	Inlet Tube		
TBK1007	1957	E-Type Hot Air Choke Tube (2 Pc.)		
TBK1008	1957	E-Type Fresh Air Choke Tube (2 Pc.)		
TBK1003	1958-60	Choke Tube (1 Pc.)		
TBK1004	1961-62	Choke Tube (2 Pc.)		
TBK1009	1963	390 CID 3 2 Barrel Carburetors (Factory M Code Car)		
TBK1006	1963-64	Choke Tube (2 Pc.)		
TBK1005	1965-66	Choke Tube (2 Pc.)		
LNK1001	1968-69	Choke Tube Set- 429 CID - 4 Barrel		

Miscellaneous & Other Lines			Thunderbird	
Part No.	Year	Description	O.E. Steel	Stainless Steel
TBA1008	1955	Distributor Vacuum (1 Pc.)		
TBO1001	1955	Carburetor & Vacuum Line (4 Pc.)		
TBO1017	1955-57	Manifold to Brake Booster		
TBA1001	1956	Distributor Vacuum Line (2 Pc.)		
TBA1002	1956	Distributor Vacuum to Intake Loop (2 Pc.)		
TBO1002	1956	Carburetor & Vacuum Line (4 Pc.)		
TBO1021	1956	Brake Booster to Manifold Vacuum Line		
TBO1029	1956-57	Brake Booster Vacuum Line		
TBA1003	1957	"E" Distributor Vacuum (1 Pc.)		
TBA1007	1957	Distributor Vacuum (1 Pc.)		
TBO1003	1957	Carburetor & Vacuum Line (4 Pc.)		
TBO1007	1957	E Manifold to Booster		
TBO1022	1957	Manifold To Booster Line - 312 CID		
TBO1024	1957	Manifold To Carburetor Line - Flat Head V8		
TBO1009	1958-60	Fuel - Pump to Wiper Motor		
TBO1010	1958-60	Manifold to Brake Booster		
TBO1011	1958-60	Power Steering Valve to Cylinder (4 Pc.)		
TBO1023	1958-60	352 CID with AC - Pump to Manifold Vacuum Line 5/16"		
TBO1030	1958-66	MX Transmission - Transmission Vent Line		
TBA1004	1958-61	Distributor Vacuum (1 Pc.)		
TBO1025	1960	Power Steering Pressure Line - 3-7/8"		
TBO1012	1961	Vacuum Tank Line - Early 1961		
TBO1013	1961	Brake Booster Vacuum Line		
TBO1014	1961-62	Power Steering Box to Return Hose - 3/8"		
TBO1028	1962	Breather Tube		
TBA1005	1962-63	Distributor Vacuum		
TBO1015	1963	Power Steering Box to Return Hose - 3/8"		
TBO1016	1963	Wiper Motor Return Lines (2 Pc.)		
TBA1006	1964-66	Distributor Vacuum		
TBO1020	1965-66	Power Steering Line - 3/8" (Ford Pump)		
TBO1031	1965-66	C6 Transmission - Transmission Vent Line		
TBO1019	1966	Manifold to Brake Booster		
TBO1026	1987-88	Turbo Coupe - Turbo Oil Return Line		

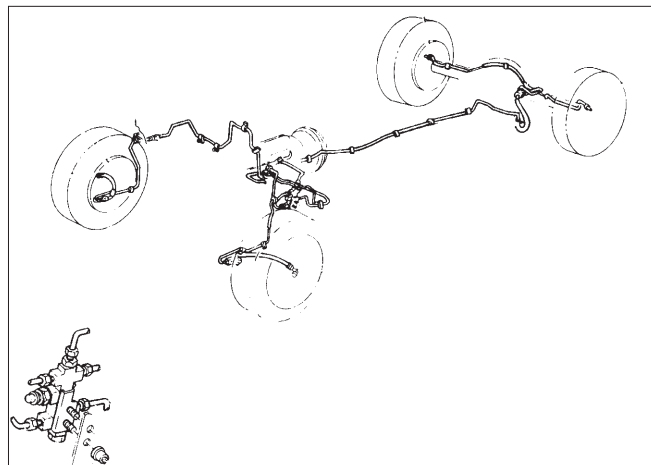
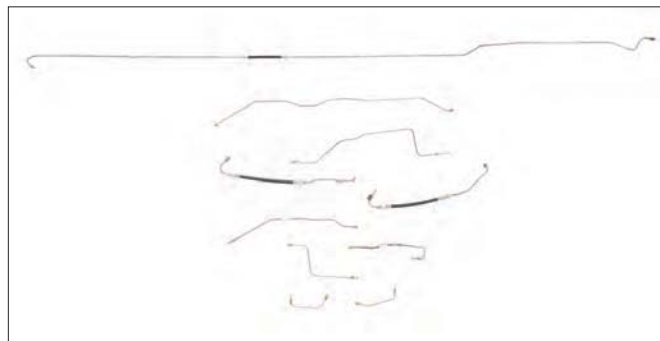

## TORINO

Complete Brake Line Kit			Torino	
Part No.	Year	Description	O.E. Steel	Stainless Steel
FR1018	1968-69	Power Disc - 8" Axle		
FR1020	1968-69	Power Disc - 9" Axle		
FR1016	1968-69	Standard Drum 8" Axle		
FR1021	1968-69	Standard Drum 9" Axle		
TN1004	1970-71	Standard Drum 8" Axle		
TN1006	1970-71	Power Disc 8" Axle		
TN1011	1970-71	Standard Drum 9" Axle		
TN1012	1970-71	Power Disc 9" Axle		
TN1010	1972-73	Gran Torino Sport Only - Fastback Power Disc 351C 4 Barrel Carburetor		
TN1013	1972-73	Gran Torino Power Disc - 8" Axle		

Fuel - Pump To Carburetor Line			Torino	
Part No.	Year	Description	O.E. Steel	Stainless Steel
TNC1003	1969	302 CID - 2 Barrel Carburetor		
MUC1015	1969-70	428 & 390 CID - 4 Barrel		
MUC1022	1969-70	429 CID CJ - 4 Barrel - Quadrajets (Only)		
FDC1022	1971	429 CJ		

Fuel - Tank To Pump Line			Torino	
Part No.	Year	Description	O.E. Steel	Stainless Steel
TNF1002	1968-69	Hardtop (2 Pc.)		
TNF1003	1968-69	Convertible (2 Pc.)		
TNF1009	1968-69	428 CJ - Hardtop		
TNF1005	1970-71	(2 Pc.)		
TNF1008	1970-71	429 SCJ (2 Pc.)		
TNR1001	1970-71	Cobra Jet Only - (2 Pc.)		
TNR1002	1970-71	(2 Pc.)		
FDF1020	1973	Gran Torino Only - Power Disc 351C 4 Barrel Carburetor		

Fuel - Vapor Line			Torino	
Part No.	Year	Description	O.E. Steel	Stainless Steel
TNV1001	1971	351C - 2 & 4 Barrel		
FDV1001	1973	Gran Torino Only - Power Disc 351C 4 Barrel Carburetor		

Transmission Lines (Sold In Pairs)			Torino	
Part No.	Year	Description	O.E. Steel	Stainless Steel
FRT1006	1967-70	V8 - C-4		
TNT1001	1969	FMX		
FRT1010	1970	C-6 - V8		
TNT1002	1971-73	C-6		

# FORD

Transmission Modulator Line			Torino	
Part No.	Year	Description	O.E. Steel	Stainless Steel
TNM1001	1970	429 CJ Engine		

Miscellaneous & Other Lines			Torino	
Part No.	Year	Description	O.E. Steel	Stainless Steel
MU01005	1968-69	428 CID (Except Shelby) Brake Booster Vacuum Lines		

## FORD TRUCK

Complete Brake Line Kit			Ford Truck	
Part No.	Year	Description	O.E. Steel	Stainless Steel
FT1001	1948-52	F1 (5 Pc.)		
FT1007	1955	F100 (5 Pc.)		
FT1012	1965	F100 2WD Longbed - Standard Drum		
FT1022	1967	F100 Standard Drum (6 Pc.)		
FT1014	1967-75	Bronco Standard Drum		
FT1030	1974	F250 4WD Power Drum (10 Pc.)		
FT1038	1976	F350 2WD Camper Special - Supercab - Dual Tanks - Power Disc		
FT1013	1976-77	Bronco Power Disc		
FT1029	1976-77	Bronco Standard Disc		
FT1004	1976-79	F150 4WD Longbed - Power Disc		
FT1011	1977-79	F250 4WD Regular Cab - Longbed - Power Disc - Lowboy		
FT1026	1977-79	F100 F150 2WD Regular Cab Longbed Power Disc		
FT1076	1977-79	F250 2WD Regular Cab Longbed Single Piston		
FT1085	1977-79	F250 2WD Extended Cab Longbed Dual Piston		
FT1086	1977-79	F250 2WD Regular Cab Longbed Dual Piston		
FT1087	1977-79	F250 2WD Extended Cab Longbed Single Piston		
FT1015	1978-79	F250 4WD Longbed - Supercab - Power Disc		
FT1031	1978-79	Bronco 4WD Power Disc - W/Sway Bar		
FT1005	1983	F250 4WD Regular Cab Longbed without Load leveler		
FT1018	1983	F250 4WD Extended Cab Longbed without Load Leveler		
FT1062	1983	F250 4WD Standard Cab Longbed with Load Leveler		

FT1063	1983	F250 4WD Extended Cab Longbed with Load Leveler		
FT1066	1983	F350 4WD Standard Cab Longbed without Load Leveler		
FT1067	1983	F350 4WD Extended Cab Longbed without Load Leveler		
FT1068	1983	F350 4WD Standard Cab Longbed with Load Leveler		
FT1069	1983	F350 4WD Extended Cab Longbed with Load Leveler		
FT1132	1983-85	Ranger Standard Cab 2WD Shortbed		
FT1050	1983-85	F150 4WD Super Cab Shortbed		
FT1097	1983-85	F150 4WD Regular Cab Shortbed		
FT1002	1983-86	Bronco Power Disc		
FT1017	1983-86	F150 4WD Standard Cab Longbed Power Disc		
FT1036	1984-85	F250 4WD Extended Cab Longbed with Load Leveler		
FT1042	1984-85	F250 4WD Extended Cab Longbed without load Leveler		
FT1049	1984-85	F250 4WD Regular Cab Longbed without Load Leveler		
FT1056	1984-85	F250 F350 4WD With Load Leveler Regular Cab Longbed		
FT1064	1984-85	F250 4WD Standard Cab Longbed with Load Leveler		
FT1071	1984-85	F350 4WD Extended Cab Longbed without Load Leveler		
FT1072	1984-85	F350 4WD Extended Cab Longbed with Load Leveler		
FT1070	1984-85	F350 4WD Standard Cab Longbed without Load Leveler		
FT1055	1986	Ranger 4WD Regular Cab Longbed 2.3 Liter 5 Speed		
FT1065	1986	F250 4WD Standard Cab Longbed without Load Leveler		
FT1050	1986	F250 F350 4WD With Load Leveler Regular Cab Longbed		
FT1061	1986	F350 4WD Standard Cab Longbed with Load Leveler		
FT1059	1986	F350 Standard Cab Longbed 4WD Dana 60 Front Axle without Load Leveler		
FT1133	1986-88	Bronco II 4WD		
FT1074	1986-88	Ranger 4WD Super Cab Shortbed		
FT1021	1988	F150 4WD Longbed Regular Cab (8 Pc.)		
FT1025	1988-89	F250 F350 4WD Longbed - 351W CID Regular Cab - Power Disc		
FT1040	1988-89	F250 F350 4WD Extended Cab Longbed - Rear Anti Lock		
FT1024	1989	Bronco II Power Disc		
FT1134	1989-92	Ranger 4WD Regular Cab Longbed		
FT1077	1989-92	Ranger 4WD Super Cab Shortbed		
FT1027	1990	Bronco 4WD Power Disc (6 Pc.)		
FT1039	1990-91	F250 F350 4WD Regular Cab - Longbed - Rear Anti Lock		
FT1047	1990-91	F150 2WD and 4WD Regular Cab Longbed		

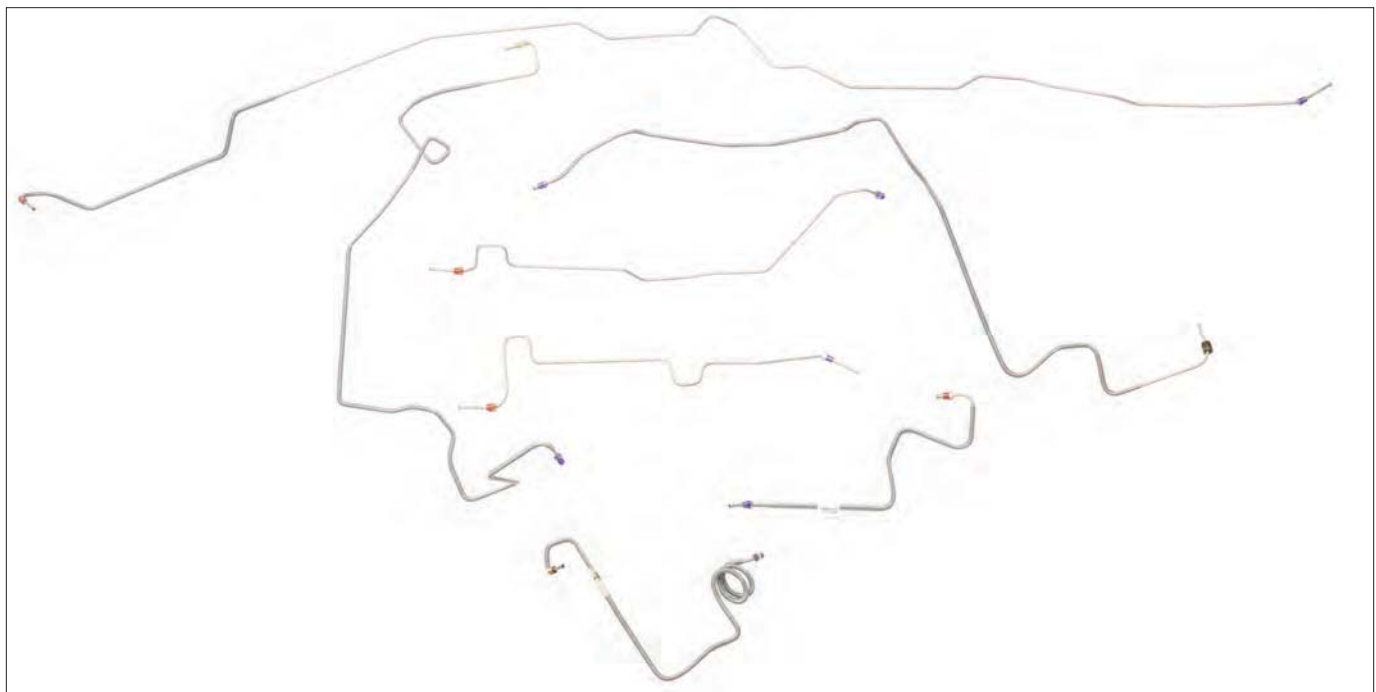

# FORD

FT1135	1992-93	F250	F350	Regular Cab Longbed	
FT1136	1992-93	F350		Crew Cab Longbed	
FT1137	1992-93	F250		Super Cab Shortbed	
FT1138	1992-93	F150		Regular Cab Longbed	
FT1139	1992-93	F150		Regular Cab Shortbed	
FT1140	1992-93	F150		Super Cab Shortbed	
FT1141	1992-93	F150		Super Cab Longbed	
FT1081	1992-96	F150		2WD and 4WD Regular Cab Shortbed	
FT1082	1992-96	F150		2WD and 4WD Extended Cab Shortbed and Super Cab Shortbed	
FT1083	1992-96	F150		2WD and 4WD Extended Cab Longbed	
FT1088	1992-96	F350		4WD Crew Cab Longbed Diesel	
FT1094	1992-96	F250		2WD and 4WD Extended Cab Shortbed and Super Cab Shortbed	
FT1037	1993	F250	F350	4WD Regular Cab - Longbed- Anti-Lock	
FT1054	1993-94	Ranger		Standard Cab 2WD Rear ABS Shortbed	
FT1092	1993-97	Ranger		Standard Cab 2WD Rear ABS Shortbed With 8.8 Axle	
FT1051	1994-96	F150		4WD Regular Cab - Longbed	
FT1095	1995	F350		4WD Crew Cab - Longbed - Anti-Lock	
FT1023	1997	F450		2WD Power Disc with Hydra Boost - 4 Wheel Disc - 137"WB	
FT1035	1997	F350		4WD Regular Cab - Dual Tanks	
FT1043	1997	F450		2WD 4 Wheel disc Hydra Boost 161" WB (Crew Cab)	
FT1089	1997	F350		2WD and 4WD Crew Cab Longbed	
FT1147	1997	F150		2WD Extended Cab Shortbed Rear ABS 8.8 Axle	
FT1096	1998	F150		2WD Regular Cab Shortbed Rear ABS 8.8 Axle	
FT1099	1998	F150		2WD Regular Cab Longbed and Extended Cab Shortbed Rear ABS 8.8 Axle	
FT1100	1998	F150		2WD Regular Cab Shortbed Rear ABS 9.75 Axle	
FT1101	1998	F150		2WD Regular Cab Longbed and Extended Cab Shortbed Rear ABS 9.75 Axle	
FT1102	1998	F150		Regular Cab Shortbed Rear ABS 8.8 Axle	
FT1103	1998	F150		4WD Regular Cab Shortbed Rear ABS 9.75 Axle	
FT1104	1998	F150		4WD Regular Cab Longbed and Extended Cab Shortbed Rear ABS 9.75 Axle	
FT1105	1998	F150		4WD Regular Cab Shortbed 4 Wheel ABS 8.8 Axle	
FT1106	1998	F150		4WD Regular Cab Longbed and Extended Cab Shortbed 4 Wheel ABS 8.8 Axle	
FT1107	1998	F150		4WD Regular Cab Shortbed 4 Wheel ABS 9.75 Axle	
FT1108	1998	F150		4WD Regular Cab Longbed and Extended Cab Shortbed 4 Wheel ABS 9.75 Axle	
FT1142	1998	F150		2WD With Rear ABS and 8.8 Axle Extended Cab Shortbed	
FT1143	1998	F150		4WD With 4 Wheel ABS and 8.8 Axle Extended Cab Shortbed	
FT1144	1998	F150		2WD With Rear ABS and 9.75 Axle Extended Cab Shortbed	
FT1060	1999	F350		4WD Super Duty Regular Cab Longbed 4 Wheel ABS Non Dual Rear Wheels	
FT1084	1999	F250		4WD Super Cab Shortbed Super Duty Rear ABS	
FT1093	1999	F350		4WD Super Duty Super Cab Longbed 4 Wheel ABS Non Dual Rear Wheels	
FT1109	1999	F350		4WD Super Cab Shortbed Super Duty Rear ABS Non Dual Rear Wheels	
FT1110	1999	F350		4WD Super Cab Shortbed Super Duty Rear ABS Dual Rear Wheels	
FT1111	1999	F250		4WD Super Cab Shortbed Super Duty 4 Wheel ABS	
FT1112	1999	F350		4WD Super Cab Shortbed Super Duty 4 Wheel ABS Non Dual Rear Wheels	
FT1113	1999	F350		4WD Super Cab Shortbed Super Duty 4 Wheel ABS Dual Rear Wheels	
FT1114	1999	F350		4WD Regular Cab Longbed Super Duty 4 Wheel ABS Dual Rear Wheels	
FT1115	1999	F350		4WD Regular Cab Longbed Super Duty Rear ABS Non Dual Rear Wheels	
FT1116	1999	F350		4WD Regular Cab Longbed Super Duty Rear ABS Dual Rear Wheels	
FT1117	1999	F350		4WD Super Cab Longbed Super Duty 4 Wheel ABS Dual Rear Wheels	
FT1118	1999	F350		4WD Super Cab Longbed Super Duty Rear ABS Non Dual Rear Wheels	
FT1119	1999	F350		4WD Super Cab Longbed Super Duty Rear ABS Dual Rear Wheels	
FT1145	1999-02			Expedition (7 Pc.)	
FT1080	2000-04	F250		4WD Superduty Supercab Shortbed - Diesel Motor	
FT1098	2000-04	F250		4WD Super Duty Super Cab Shortbed - Gas Motor	
FT1120	2000-04	F350		4WD Super Cab Shortbed Super Duty Diesel Motor Non Dual Rear Wheels	
FT1121	2000-04	F350		4WD Super Cab Shortbed Super Duty Diesel Motor Dual Rear Wheels	
FT1122	2000-04	F350		4WD Super Cab Shortbed Super Duty Gas Motor Non Dual Rear Wheels	
FT1123	2000-04	F350		4WD Super Cab Shortbed Super Duty Gas Motor Dual Rear Wheels	
FT1124	2000-04	F350		4WD Regular Cab Longbed Super Duty Diesel Motor Non Dual Rear Wheels	
FT1125	2000-04	F350		4WD Regular Cab Longbed Super Duty Diesel Motor Dual Rear Wheels	
FT1126	2000-04	F350		4WD Regular Cab Longbed Super Duty Gas Motor Non Dual Rear Wheels	
FT1127	2000-04	F350		4WD Regular Cab Longbed Super Duty Gas Motor Dual Rear Wheels	
FT1128	2000-04	F350		4WD Super Cab Longbed Super Duty Diesel Motor Non Dual Rear Wheels	
FT1129	2000-04	F350		4WD Super Cab Longbed Super Duty Diesel Motor Dual Rear Wheels	
FT1130	2000-04	F350		4WD Super Cab Longbed Super Duty Gas Motor Non Dual Rear Wheels	
FT1131	2000-04	F350		4WD Super Cab Longbed Super Duty Gas Motor Dual Rear Wheels	
FT1148	2000-04	F350		4WD Superduty Super Cab Longbed - Diesel Motor	
FT1146	2000-06	Excursion		4WD (8 Pc.)	

**Caliper Inlet Lines & Transfer Tubes (Sold in Pairs)**

Part No.	Year	Description	O.E. Steel	Stainless Steel	Ford Truck
FTD1001	1966-75	Bronco Front Inlet Lines (2 Pc.)			

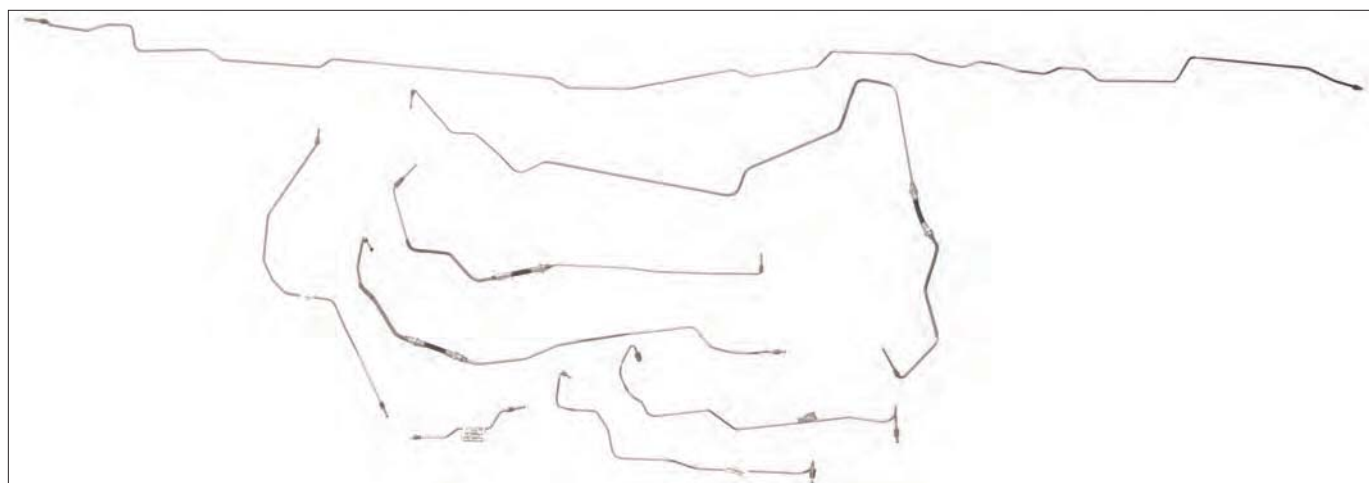

# FORD

## Fuel - Pump To Carburetor Line

Part No.	Year	Description	Ford Truck	
			O.E. Steel	Stainless Steel
FTC1012	1948-50	F1		
FTC1003	1950	F1 Straight 6 - 1/4"		
FTC1002	1954-56	F100		
FTC1007	1965	Truck 4WD 360 CID		
FTC1016	1966	Truck		
FTC1018	1966	Bronco 170 CID		
FTC1011	1969	F100 360 CID & 390 CID		
FTC1017	1971	F100 302 CID		
FTC1014	1976	F350 2WD Camper Special - Dual Tanks Supercab Power Disc		
FTC1019	1976	F100 F250 4WD 360 CID		
FTC1009	1977-79	F100 F150 Bronco 302 - 2 Barrel		
FTC1015	1978-79	Bronco & F150 351M		
FTC1010	1978-79	F150 Bronco 351 CID & 400 CID		
FTC1013	1981	F100 300CID		
FTC1008	1982	F150 4WD 300 CID Automatic		
FTC1004	1984-85	F250 351W - 4 Barrel - Holley		
FTC1005	1987	Van E150 351W		
FTC1006	1987	F250 351W CID 5.8 Liter - 5/16"		

## Fuel - Tank To Pump Line

Part No.	Year	Description	Ford Truck	
			O.E. Steel	Stainless Steel
FTF1026	1941	Truck 1/4" (1 Pc.)		
FTF1001	1950	F1 (2 Pc.)		
FD1003	1951	Wagon Fuel line		
FTF1021	1951	F1		
FTF1002	1955	F100 With 6 Cylinder Motor		
FTF1027	1964	F100 5/16" (1 Pc.)		
FTF1013	1967	F100 Shortbed		
FTF1005	1972	F150 4WD Longbed - Tank Behind Drivers Seat		
FTF1016	1973-74	F250 4WD (3 Pc.)		
FTF1006	1975	F150 2WD - Dual Tank		
FTF1006	1975	F350 4WD Super Cab 155" Wheelbase		
FTF1006	1975	F250 4WD Crew Cab 155" Wheelbase.		
FTF1037	1975	F250 4WD Crew Cab 155" Wheelbase - with Dual Tanks (3 pc.)		
FTF1037	1975	F350 4WD Super Cab 155" Wheelbase - with Dual Tanks (3 pc.)		
FTF1018	1976	F350 2WD Camper Special - Supercab - Power Disc - Dual Tanks		
FTF1020	1976-77	F100 4WD Super Cab 155" Wheelbase		
FTF1003	1976-79	F250 4WD Longbed Supercab 155" Wheelbase		
FTF1019	1976-79	F250 F350 4WD Regular Cab - Longbed - 133" WB (2 Pc.)		
FTF1020	1976-79	F250 F350 4WD Supercab Longbed - 155" WB - Dual Tanks (3 Pc.)		
FTF1022	1976-79	F250 F350 4WD Crew Cab Longbed dual tank 168" WB		
FTF1024	1976-79	F250 F350 4WD Crew Cab Longbed - 168" WB - Dual Tanks (3 Pc.)		
FTF1014	1977	Bronco Tank Line - 3/8" (3 Pc.)		
FTF1007	1978	F100 2WD		
FTF1009	1978	F250 4WD Supercab - Longbed		
FTF1028	1978	Bronco 3/8" (2 Pc.)		
FTF1003	1978-79	F150 4WD Super Cab 155" Wheelbase		
FTF1003	1978-79	F350 4WD Super Cab 155" Wheelbase		
FTF1017	1978-79	F250 4WD Regular Cab 133" Wheelbase		
FTF1038	1978-79	F250 4WD Super Cab and Crew Cab 155" Wheelbase		
FTF1038	1978-79	F150 4WD Super Cab 155" Wheelbase		
FTF1038	1978-79	F350 4WD Super Cab 155" Wheelbase		
FTF1039	1978-79	F150 4WD Regular Cab 133" Wheelbase		
FTF1039	1978-79	F250 4WD Regular Cab 133" Wheelbase		
FTF1040	1978-79	F250 4WD Crew Cab 155" Wheelbase		
FTF1015	1979	F150 2WD V8 - 302 CID - 2 Barrel		
FTF1017	1979	F150 4WD Shortbed		
FTF1030	1980	Bronco 302 CID 5/16" (2 Pc.)		
FTF1004	1981	F150 4WD V8		
FTF1023	1982-86	F150 Super Cab Longbed - V8 - (2 Pc.)		

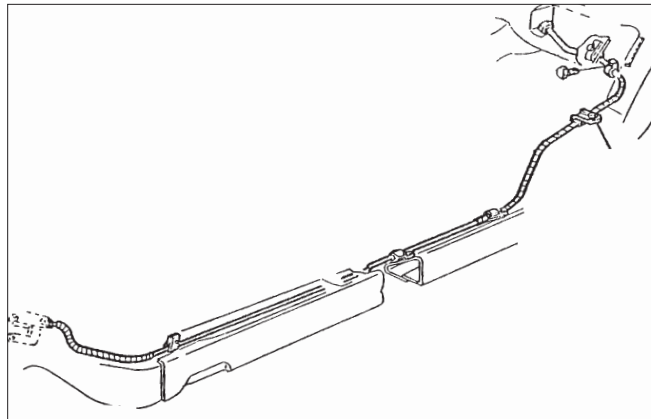

FTF1023	1983	F250 Extended Cab - Longbed - V8 - (2 Pc.)		
FTF1033	1983	F250 4WD 5.0 Liter Dual Tank Valve to Pump Line		
FTF1029	1983-86	F350 4WD Regular Cab Longbed - Diesel - (3 Pc.)		
FTF1029	1984	F250 4WD Regular Cab - Longbed - Diesel - (3 Pc.)		
FTF1025	1986	F150 4WD Shortbed - 5/16"		
FTF1041	1987-90	F150 Regular Cab Shortbed (2 pc.)		
FTF1035	1994	F350 4WD Crew Cab Longbed		
FTF1034	2001	F250 4WD Superduty		
FTF1036	2001	F350 Diesel		

## Fuel - Return Line

Part No.	Year	Description	Ford Truck	
			O.E. Steel	Stainless Steel
FTR1005	1976	F100 2WD Longbed		
FTR1009	1978	F250 4WD Longbed - Supercab		
FTR1011	1979	F250 4WD Longbed - Supercab - 1/4" (4 Pc.)		
FTR1015	1979	F250 4WD Longbed (2 Pc.)		
FTR1002	1984	Bronco (2 Pc.)		
FTR1001	1986	F150 4WD Shortbed - 3/16"		
FTR1004	1986	F250 4WD Longbed - 3/16" (3 Pc.)		
FTR1016	1994	F350 4WD Crew Cab Longbed		
FTR1013	1996	F350 7.3 Diesel - Injection Return Line		
FTR1014	2001	F250 4WD Superduty		
FTR1017	2001	F350 Diesel		

## Fuel - Vapor Line

Part No.	Year	Description	Ford Truck	
			O.E. Steel	Stainless Steel
FTV1002	1984	F250 4WD Regular Cab - Longbed - Diesel - (2 Pc.)		
FTV1003	1984	Bronco (2 Pc.)		
FTV1001	1986	F150 4WD Shortbed - 3/16"		
FTV1006	1988	F150 Regular Cab Shortbed		
FTV1004	1992	Bronco (2 Pc.) - 302 CID Full Size		
FTV1005	2001	F250 4WD Superduty (4 Pc. Set)		

## Fuel - Miscellaneous

Part No.	Year	Description	Ford Truck	
			O.E. Steel	Stainless Steel
FTF1032	1996	F350 7.3 Diesel - Injection Line		

## Transmission Lines (Sold In Pairs)

Part No.	Year	Description	Ford Truck	
			O.E. Steel	Stainless Steel
FTT1006	1973-77	Bronco 4WD V8 - C-4		
FTT1002	1975-79	F250 2WD 351C - 351M - 400M - C-6		
FTT1004	1975-79	F250 4WD Inline Cooler - (4 Pc.) includes new 1/2-20 Radiator Adapter Fittings		
FTT1020	1976	F350 2WD Dual Tanks - Camper Special		
FTT1001	1976-79	F350 4WD 400M Engine - C6		
FTT1008	1978	F100 2WD		

# FORD

FTT1011	1979	F150 2WD 302 CID - V8
FTT1025	1980	Bronco 302 - C4
FTT1016	1981	F100 300 CID - C4
FTT1005	1984	F250 4WD C-6 - Includes Adapter at Radiator - No Auxiliary Cooler
FTT1018	1984	F250 4WD C-6 W/Auxiliary Oil Cooler (4 Pc.)
FTT1014	1986	1500 4WD C-6 Factory Transmission Cooler
FTT1017	1986	F150 2WD
FTT1019	1987	F250 Diesel 4WD
FTT1009	1990	F350 (4 Pc.)
FTT1022	1993	Van - E150 6 Cylinder E4 Overdrive
FTT1013	1993-97	F250 4WD E4 Overdrive with Cooler Includes New Radiator Adapter Fittings (4 Pc.)
FTT1013	1993-97	F350 4WD E4 Overdrive with Cooler Includes New Radiator Adapter Fittings (4 Pc.)
FTT1021	1993-97	F250 4WD E4 Overdrive without Cooler Includes New Radiator Adapter Fittings (2 Pc.)
FTT1021	1993-97	F350 4WD E4 Overdrive without Cooler Includes New Radiator Adapter Fittings (2 Pc.)
FTT1021	1993-97	Truck - Bronco 4WD E4 Overdrive without Cooler Includes New Radiator Adapter Fittings (2 Pc.)
FTT1021	1993-97	Truck - F150 4WD E4 Overdrive Without Cooler Includes New Radiator Adapter Fittings (2 Pc.)
FTT1027	1995	Van - E150
FTT1026	1997	Expedition 5.4 Liter 4R70W
FTT1031	1997	Truck - Expedition 4.6 Liter 4R70W
FTT1028	1998	Van - Windstar 3.0 Liter
FTT1029	2000	F250 7.3 Diesel
FTT1030	2001	F250 4WD Superduty

Transmission Modulator Line			Ford Truck	
Part No.	Year	Description	O.E. Steel	Stainless Steel
FTM1002	1973-77	Bronco V8 - C4		
FTM1008	1975-79	F100 2WD		
FTM1001	1980-91	Truck - F250 1/4"		
FTM1001	1990	F350 1/4"		

Choke Tube			Ford Truck	
Part No.	Year	Description	O.E. Steel	Stainless Steel
MUK1002	1964-69	Truck 170 CID 200 CID (1Pc.)		
MUK1003	1967-68	Truck 390 CID - 4 Barrel (2 Pc.)		
MUK1017	1968-69	Small Block Motor With Holley Carburetor and Aluminum Intake (2 Pc.)		
MUK1008	1969-70	Truck 351W - 2 Barrel - Enter Through Bottom of Choke Housing (2 Pc.)		
MUK1009	1969-70	Mustang 351W - 4 Barrel - Enter Through Side of Choke Housing (2 Pc.)		

Miscellaneous & Other Lines			Ford Truck	
Part No.	Year	Description	O.E. Steel	Stainless Steel
FTO1010	1949	F1 Distributor Vacuum Line - 6 Cylinder		
FTO1001	1951	F1 Distributor Vacuum Line - 3/16"		
FTO1002	1951	F150 F-1 - Oil Line 1/4" - Filter to Crank Case & Gallery to Oil Filter (2 Pc.)		
FTO1005	1951	F1 Distributor Vacuum Line - Straight 6		
FTO1009	1951	F1 Distributor Vacuum Line - 6 cylinder		
FTO1006	1955	F100 Distributor Vacuum Line		
FTO1021	1966	Truck - Bronco 170 CID - Distributor Vacuum Line		
FTO1022	1966	Bronco 170 CID - Pump to Wiper Vacuum Line		
FTO1003	1973-77	Bronco V8 - PCV Line		
FTO1017	1978	F100 Power Steering Cooler Line		
FTO1018	1979	F350 4WD 400 CID Power Steering Cooler Line		
FTO1007	1984	Bronco Power Steering Cooling Line		
FTO1008	1984	Bronco Vacuum Modulator Line		
FTO1014	1984	F250 4WD 351 CID Power Steering Cooling Line		
FTO1015	1984	F250 4WD 460 CID Power Steering Cooling Line		
FTO1013	1984-91	F150 4WD Power Steering Cooling Line V8 C6 E4-OD Power/Disc Regular Cab Longbed		
FTO1011	1987	F350 Power Steering Cooling Line - 460 CID - 4 Speed		
FTO1019	1989	Ranger Power Steering Return Line		
FTO1023	1991-93	Bronco V8 Motor - TBI Pre Heater Line		
FTO1023	1991-93	F150 V8 Motor - TBI Pre Heater Line		
FTO1016	1996	F350 4WD Power Steering Cooler Line		
FTF1032	1996	Truck - F350 7.3 Diesel - Injection Line F.I. Feed Line		
FTO1020	2001	F250 4WD Superduty - Power Steering Lines		
FTO1024	2004	F250 5.4 Liter Motor - Fuel Line Set 3 Pc. - (7/16" tubes are made in 3/8" tubing)		

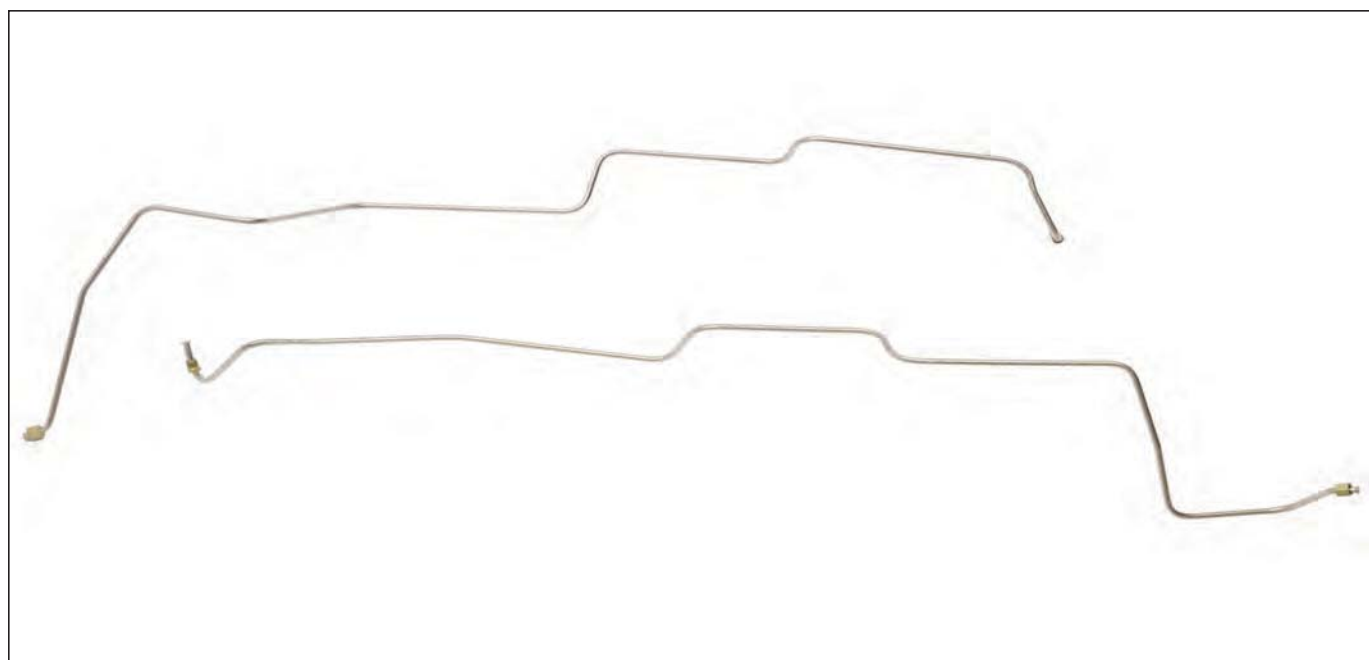

# SHELBY

## GT 350 & GT 500

### Complete Brake Line Kit GT 350 & GT 500

Part No.	Year	Description	O.E. Steel	Stainless Steel
MU1005	1965	GT 350 Standard Disc		
MU1081	1966	GT 350 Standard Disc		
MU1015	1967	GT 350 GT 500 Power Disc - 9" Axle (Built Before Feb. 1967) Right Front and Front to Rear Route Over Steering Box		
MU1016	1967	GT 350 GT 500 Power Disc - 9" Axle (Built After Feb. 1967) Right Front and Front to Rear Routes Under Steering Box		
MU1025	1968-70	GT 350 Power Disc - 9" Axle - 28 Spline		
MU1026	1968-70	GT 500 Power Disc - 9" Axle - 31 Spline		

### Rubber Brake Hose GT 350 & GT 500

Part No.	Year	Description	O.E. Steel	Stainless Steel
RH7001	1965-66	Front Disc Flex Hose - 3/8" Inlet		
RH7007	1965-66	GT350 Rear Flex Hose - Dual Exhaust Hi-Po		
RH7002	1967	GT 350 GT 500 Front Disc Flex Hose - 7/16" Inlet		
RH7006	1967	GT500 Rear Flex Hose - 28 Spline		
RH7006	1967-69	GT350 Rear Flex Hose - 28 Spline		
RH7004	1968-70	GT 350 GT 500 Left Front Flex Hose - Disc		
RH7005	1968-70	GT 350 GT 500 Right Front Flex Hose - Disc		
RH7011	1968-70	GT500 Rear Flex Hose - 31 Spline - Big Block		

### Caliper Inlet Lines & Transfer Tubes (Sold in Pairs) GT 350 & GT 500

Part No.	Year	Description	O.E. Steel	Stainless Steel
MUD1001	1965-67	GT 350 GT 500 4 Piston - Kelsey Hayes - Disc Brake Transfer Tube		

### Fuel - Pump To Carburetor Line GT 350 & GT 500

Part No.	Year	Description	O.E. Steel	Stainless Steel
MUB1001	1964-67	GT 350 Holley - 715 CFM - Center Pivot - Bowl to Bowl Transfer Tube		
MUC1004	1965	GT 350 289 CID - Carburetor Line - W/ Holley 715 CFM		
MUC1008	1966-67	GT 350 289 CID - W/ 715 CFM - Holley (Shelby)		
MUC1011	1967	GT 500 428 CID - (2) 4 Barrel		
MUC1035	1967	GT 350 W/ Holley 715 CFM and Power Steering		
MUC1013	1968	GT 350 302 CID - 4 Barrel		
MUB1002	1968-70	GT 500 Holley - 735 / 780 CFM - Bowl to Bowl Transfer Tube		
MUC1015	1968-70	GT 500 428 & 390 CID - 4 Barrel		
MUC1014	1969-70	GT 350 351 CID - 4 Barrel		

### Fuel - Tank To Pump Line GT 350 & GT 500

Part No.	Year	Description	O.E. Steel	Stainless Steel
MUF1002	1965-66	GT 350 - 5/16"		
MUF1003	1965-66	GT 350 - 3/8" (Race)		
MUF1005	1967	GT 350 - Early - 5/16" (1 Pc.) - Runs Down Tunnel		
MUF1006	1967-68	GT 350 (Late 1967 & All 1968) 5/16" (2 Pc.) - Runs Down Rocker		
MUF1007	1967-68	GT 500 (Late 1967 & All 1968) 3/8" (2 Pc.) Runs Down Rocker		
MUF1008	1968	GT 500 - 428CJ - Stagger Rear Shock		
MUF1009	1969-70	GT 350 - 3/8" (2 Pc.)		
MUF1010	1969-70	GT 350 GT 500 - 3/8" (2 Pc.) W/ Factory Rear Sway Bar		

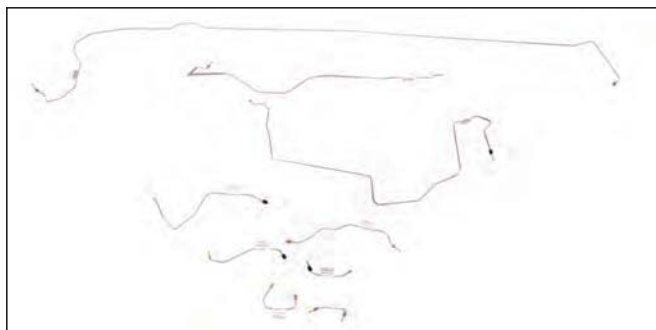

### Fuel - Vent Line GT 350 & GT 500

Part No.	Year	Description	O.E. Steel	Stainless Steel
MUV1011	1969-70	Trunk Mount GT-500		

### Transmission Lines (Sold In Pairs) GT 350 & GT 500

Part No.	Year	Description	O.E. Steel	Stainless Steel
MUT1004	1966	GT 350 C-4 - V8		
MUT1007	1967-68	GT 500 C-6 - to early 1968		
MUT1006	1967-70	GT 350 C-4 - V8		
MUT1008	1968-70	GT 500 C-6 - V8 - Late 1968 - UP		
MUT1009	1969-70	GT 350 351W - FMX - V8 - Heavy Duty Cooling		

### Transmission Modulator Line GT 350 & GT 500

Part No.	Year	Description	O.E. Steel	Stainless Steel
MUM1003	1966	GT 350 V8 - C4 - Hose on Both Ends		
MUM1005	1967-69	GT 350 V8 - C4		
MUM1006	1967-70	GT 500 V8 - C6		

### Choke Tube GT 350 & GT 500

Part No.	Year	Description	O.E. Steel	Stainless Steel
MUK1004	1967	GT 500 428 CID - 2-4 Barrel Dual Quad (2 Pc.)		
MUK1005	1968	GT 350 302 - 4 Barrel (2 Pc.)		
MUK1006	1968-70	GT 500 428 CID - 4 Barrel		
MUK1009	1969-70	GT 350 351W - 4 Barrel - Enter Through Side of Choke Housing (2 Pc.)		

### Miscellaneous & Other Lines GT 350 & GT 500

Part No.	Year	Description	O.E. Steel	Stainless Steel
MUO1002	1967	GT350 350 & 289 CID - V8 Brake Booster Vacuum Lines		
MUO1009	1967	GT 500 428 CID Brake Booster Vacuum Lines - (2) 4 Barrel - 4 Speed		
MUO1004	1968	GT 350 Brake Booster Vacuum Line 302 CID - V8		
MUO1006	1968-69	GT 500 Brake Booster Vacuum Line 428 CID		
MUO1007	1969-70	GT 350 Brake Booster Vacuum Line 351W		

## COBRA

### Complete Brake Line Kit Cobra

Part No.	Year	Description	O.E. Steel	Stainless Steel
AC1002	1962-63	260 CID - Single Master Cylinder System		
AC1005	1962-63	289 CID - Single Master Cylinder System		
AC1003	1963-65	289 CID - Dual Master Cylinder		
AC1004	1965-67	427 CID		

### Caliper Inlet Lines & Transfer Tubes (Sold in Pairs) Cobra

Part No.	Year	Description	O.E. Steel	Stainless Steel
ACD1001	1962-67	Front Girling Caliper Transfer Tube		
ACD1002	1968-73	Rear Girling Caliper Transfer Tube		

### Fuel - Pump To Carburetor Line Cobra

Part No.	Year	Description	O.E. Steel	Stainless Steel
ACC1001	1962-63	260 CID - Carburetor Line 4 Barrel		
MUC1004	1965	289 CID - Carburetor Line - W/ Holley 715 CFM		
ACC1003	1965-67	427 CID - 2-4 Barrel		
ACC1004	1965-67	2-4 Barrel or 1-4 Barrel - Inline Filter 3/8" (2 Pc.) to Fuel Log		

### Fuel - Tank To Pump Line Cobra

Part No.	Year	Description	O.E. Steel	Stainless Steel
ACF1005	1965-67	427 CID - Tank to Pump Street Car Only		

### Hydraulic Clutch Line Cobra

Part No.	Year	Description	O.E. Steel	Stainless Steel
ACH1002	1962-65	260 and 289 CID		
ACH1004	1962-65	260 and 289 CID - Competition		
ACH1003	1965-67	427 CID		

# LINCOLN

## LINCOLN EARLY & MISC.

### Complete Brake Line Kit

			Lincoln Early & Misc.	
Part No.	Year	Description	O.E. Steel	Stainless Steel
LN1001	1939-42	Continental Zephyr		
LN1002	1946-48	Continental		
LN1004	1956	Continental - Mark II Convertible		
LN1016	1956-57	Premier		
LN1021	1957	Premier		
LN1005	1958	Continental - Mark II		
LN1005	1958	Continental - Mark IV		
LN1006	1960	Continental - Mark V 1960		
LN1007	1961-63	Continental		
LN1008	1965	Continental		
LN1024	1966	Continental 4 Door		
LN1013	1967	Continental (12 Pc.)		
LN1027	1968	Continental Power Brake		
LN1019	1970	Mark III Non Sure Track System		
LN1017	1971	Mark III Power Drum - Sure Track (8 Pc.)		
LN1020	1996	Town Car With ABS Without Traction Control		
LN1022	1996-97	Town Car With ABS With Traction Control		
FT1145	1999-02	Navigator		

### Caliper Inlet Lines & Transfer Tubes (Sold in Pairs)

			Lincoln Early & Misc.	
Part No.	Year	Description	O.E. Steel	Stainless Steel
LND1003	1965	Continental Caliper Inlet Lines - Pair		
LND1002	1965-66	Continental Caliper Transfer Tubes (2 Pc.)		
TBD1001	1965-69	All Models Disc Brake - 4 Piston - Kelsey-Hayes Caliper - Cross Over Tubes		
LND1004	1966-67	All Models Front Inlet Lines (2 Pc.)		

### Fuel - Pump To Carburetor Line

			Lincoln Early & Misc.	
Part No.	Year	Description	O.E. Steel	Stainless Steel
LNC1002	1952-54	All Models 317 CID - 4 Barrel - 5/16"		
LNC1005	1953	Mark III 460 CID - 5/16"		
LNC1011	1956	Mark II		
LNC1013	1956	Continental Fuel Pump to Carburetor Line		
LNC1001	1958	All Models 3/8" (1 Pc.)		
LNC1010	1962	Convertible 430 CID Large Case FMX Trans 2 Barrel Carburetor		
LNC1003	1965	All Models		
LNC1012	1966-67	Continental		
LNC1008	1968	Continental 5/16"		
LNC1006	1969	Mark III		
LNC1007	1971	Mark III 460 CID		
LNC1009	1976	Mark IV 460 CID - 4 Barrel		

### Fuel - Tank To Pump Line

			Lincoln Early & Misc.	
Part No.	Year	Description	O.E. Steel	Stainless Steel
LNF1001	1953-54	All Models		
LNF1010	1956	Premier		
LNF1002	1956-57	All Models 5/16" (1 Pc.)		
LNF1003	1958	Mark III 3/8" (2 Pc.)		
LNF1007	1959-60	Mark III 3/8" (2 Pc.)		
LNF1004	1961-62	All Models (2 Pc.)		
LNF1009	1964-65	All Models		
LNF1008	1966-67	All Models Convertible - 3/8" (2 Pc.)		
LNF1006	1969	All Models		
LNF1011	1971	Mark III 460 CID - 3/8"		

### Fuel - Return Line

			Lincoln Early & Misc.	
Part No.	Year	Description	O.E. Steel	Stainless Steel
LNR1005	1962	All Models (2 Pc.)		
LNR1003	1964	All Models		
LNR1002	1964-65	Continental (2 Pc.)		
LNR1001	1966-67	All Models Convertible - 3/16" (2 Pc.)		

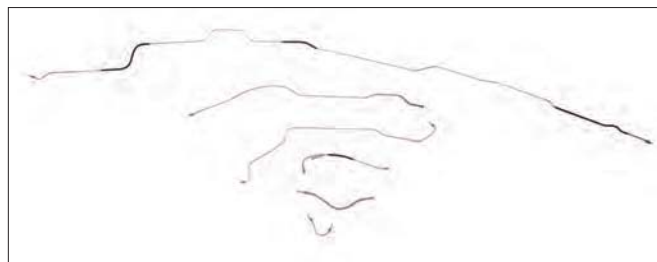

### Fuel - Vapor Line

			Lincoln Early & Misc.	
Part No.	Year	Description	O.E. Steel	Stainless Steel
LNV1002	1961-63			
LNV1003	1961-63	Sedan		
LNV1001	1971	Mark III 460 CID		

### Fuel - Miscellaneous

			Lincoln Early & Misc.	
Part No.	Year	Description	O.E. Steel	Stainless Steel
LNF1017	1990-94	Town Car Fuel - Filter to Fuel Rail - 5/16"		
LNF1016	1997	Town Car Fuel - Filter to Fuel Rail - 5/16"		

### Transmission Lines (Sold In Pairs)

			Lincoln Early & Misc.	
Part No.	Year	Description	O.E. Steel	Stainless Steel
LNT1001	1956-57	All Models		
LNT1002	1959	1959 1960 All Models		
LNT1010	1962	Convertible 430 CID Large Case FMX Trans 2 Barrel Carburetor		
LNT1009	1964-65	All Models 3/8"		
LNT1007	1966	All Models 3/8"		
LNT1003	1967	All Models 3/8"		
LNT1005	1971	Mark III 460 CID - C6		
LNT1008	1991	Continental		

### Transmission Modulator Line

			Lincoln Early & Misc.	
Part No.	Year	Description	O.E. Steel	Stainless Steel
LNM1003	1962	Convertible 430 CID Large Case FMX Trans 2 Barrel Carburetor		
LNM1002	1965	All Models Hardtop - Convertible		
LNM1004	1967	Continental 462 CID		
LNM1001	1971	Mark III C6 - 460 CID - 1/4"		

### Miscellaneous & Other Lines

			Lincoln Early & Misc.	
Part No.	Year	Description	O.E. Steel	Stainless Steel
LN01001	1946	Zephyr Convertible Hydraulic Top Lines (4 Pc.)		
LN01004	1952-54	All Models Vacuum Line (2 Pc.)		
LNA1001	1956	Mark II Distributor Vacuum Line Set (2 Pc.)		
LN01006	1956	Continental Heat Riser Pump to Wiper		
LN01016	1956	Mark II Fuel Pump to Vacuum Block Line		
LN01017	1956	Mark II Fuel Pump to Intake Line		
LN01018	1956	Continental Fuel Pump to Fuel Block Line		
LN01003	1958	All Models Distributor Vacuum Line - 430 CID		
LN01022	1960	Continental Distributor Vacuum Line		
LN01008	1961	Choke Tube (2 Pc.)		
LN01010	1962	Convertible Wiper motor to Reservoir Line		
LN01011	1962	Convertible 430 CID Power Gear Box to Wiper Motor		
LN01012	1962	Convertible 430 CID High Pressure Power Steering Feed Line		
LN01013	1962	Convertible 430 CID Distributor Vacuum advance line		
LN01014	1964-65	All Models Power Steering Pump to Box Line		
LN01015	1964-65	All Models Steering Box to Wiper Motor Line		
LN01005	1965	Continental Power Steering Line		
LN01009	1965	Continental Convertible - Distributor Vacuum Line		
LN01020	1967	Continental 462 CID - Power Steering Pressure Line		
LN01021	1967	Continental Wiper motor Bypass Valve Line		
LN01019	1967	Continental Transmission Vent Line		
LN01007	1969	Mark III Booster Vacuum Line - 460 CID		

## MERCURY

### MERCURY EARLY & MISC.

#### Complete Brake Line Kit Mercury Early & Misc.

Part No.	Year	Description	O.E. Steel	Stainless Steel
MR1015	1939	All Models 2 Door - 4 Door		
MR1010	1941-42	Wagon (6 Pc.)		
MR1010	1946-48	Wagon (6 Pc.)		
MR1008	1946-48	Non Wagon Models (6 Pc.)		
MR1001	1949-51	Eight		
MR1009	1952-53	Monterey Non Wagon		
MR1006	1954	Monterey Non Wagon		
MR1011	1954	Wagon		
FD01019	1955	Monterey Fuel - Pump to Wiper 272 CID and 292 CID 2 Barrel Carburetor (2 Pc.)		
MR1016	1955-56	Monterey Standard Drum		
MR1005	1956	Monterey Power Brakes		
MR1020	1957-58	Monterey Standard Brake		
MR1021	1957-58	Monterey Power Brake		
CM1001	1960-63	Comet		
MR1007	1962	Monterey Power Brakes		
CM1002	1964-65	Comet Standard Drum		
CM1002	1964-65	Cyclone Standard Drum		
CM1005	1966	Power Drum		
CM1005	1966	Cyclone Power Drum		
CM1006	1966	Comet (6 Pc.)		
CM1006	1966	Cyclone (6 Pc.)		
MR1014	1966	Monterey 2 Door - Power Drum - Hardtop		
MR1019	1967	Monterey Power Disc		
MR1017	1967-68	Monterey Standard Drum		
MR1018	1967-68	Monterey Power Drum		
MR1013	1968	Park Lane Monterey 4 Door - Hardtop - Disc Brakes		
FR1016	1968-69	Cyclone Standard Drum 8" Axle		
FR1016	1968-69	Comet Standard Drum - 8" Axle		
FR1018	1968-69	Cyclone Power Disc - 8" Axle		
FR1020	1968-69	Cyclone Power Disc - 9" Axle		
FR1021	1968-69	Cyclone Standard Drum 9" Axle		
FD1032	1972	Comet Standard Drum		
FD1032	1972	Maverick Grabber Standard Drum		
FD1039	1997	Sable Without ABS		

#### Caliper Inlet Lines & Transfer Tubes (Sold in Pairs) Mercury Early & Misc.

Part No.	Year	Description	O.E. Steel	Stainless Steel
MRD1002	1965-67	Monterey Disc Brake - 4 Piston Kelsey-Hayes Caliper - Inlet Lines		
FDD1001	1996-99	Sable Without ABS - Rear Inlet Line Set		

#### Fuel - Pump To Carburetor Line Mercury Early & Misc.

Part No.	Year	Description	O.E. Steel	Stainless Steel
MRC1005	1953	4 Door Sedan - V8 - Flat Head		
MRC1006	1954	Monterey Non Wagon		
FDC1029	1965-66	All Models 390 CID - 4 Barrel - Holley (Factory)		
MRC1003	1966-67	Cyclone 390 CID		

#### Fuel - Tank To Pump Line Mercury Early & Misc.

Part No.	Year	Description	O.E. Steel	Stainless Steel
MRF1001	1949-51	All Models Coupe		
MRF1010	1951	Cosmo Convertible		
MRF1007	1952	Monterey (2 Pc.)		
MRF1011	1953	4 Door Sedan - 8 Cylinder - Flat Head		
MRF1009	1954	Sedan (2 Pc.)		
MRF1012	1954	Wagon (2 Pc.)		
MRF1006	1962	Comet 6 Cylinder		
MRF1008	1962	Monterey V8		
MRF1004	1963	Comet 4 Door - 6 Cylinder - 5/16"		
MRF1002	1965	Cyclone Inside Frame		



MRF1003	1965	Cyclone Convertible - 5/16"		
MRF1005	1966	Cyclone 5/16"		
MRF1013	1966	Cyclone 390 CID - 4 Barrel - 9" Rear		
MRF1014	1968-69	Cyclone 1 (Pc.) Fuel Line		

#### Transmission Lines (Sold In Pairs) Mercury Early & Misc.

Part No.	Year	Description	O.E. Steel	Stainless Steel
MRT1001	1957	All Models		
MRT1002	1965-66	All Models MX		
FRT1018	1967	Comet 390 CID C6 Transmission		

#### Transmission Modulator Line Mercury Early & Misc.

Part No.	Year	Description	O.E. Steel	Stainless Steel
MRM1002	1967-68	Park Lane 2 Barrel - 390 CID		
MRM1002	1968	C-6		

#### Choke Tube Mercury Early & Misc.

Part No.	Year	Description	O.E. Steel	Stainless Steel
MRK1002	1953	4 Door Sedan - V8 Manifold to Carburetor		
MRK1001	1958	Comet 6 Cylinder		

#### Miscellaneous & Other Lines Mercury Early & Misc.

Part No.	Year	Description	O.E. Steel	Stainless Steel
MRO1001	1951	Cosmo Distributor Vacuum Lines		
MRO1002	1951	Cosmo Fuel - Pump to Manifold		
MRO1004	1956	All Models Pump to Manifold - Vacuum Line		
MRO1005	1956	All Models Distributor Vacuum Line		
MRO1003	1963	Comet Distributor Vacuum Line - 170 CID - 6 Cylinder		

### COUGAR

#### Complete Brake Line Kit Cougar

Part No.	Year	Description	O.E. Steel	Stainless Steel
CO1001	1967	Standard Drum - V8 - 8" and 9" Axle - Early (Built Before Feb. 1967)		
CO1002	1967	Power Drum - V8 - 8" and 9" Axle - Early (Built Before Feb. 1967)		
CO1003	1967	Power Disc - V8 - 8" and 9" Axle - Early (Built Before Feb. 1967)		
CO1022	1967	Standard Drum - V8 - 8" and 9" Axle Late (Built After Feb. 1967)		
CO1023	1967	Power Drum - V8 - 8" and 9" Axle Late (Built After Feb. 1967)		
CO1024	1967	Power Disc - V8 - 8" and 9" Axle Late (Built After Feb. 1967)		
CO1004	1968-69	Standard Drum - 8" Axle		
CO1005	1968-69	Standard Drum - 9" Axle - 28 Spline		
CO1006	1968-69	Standard Drum - 9" Axle - 31 Spline		
CO1008	1968-69	Power Drum - 9" Axle - 28 Spline		
CO1009	1968-69	Power Drum - 9" Axle - 31 Spline		
CO1007	1968-69	Power Drum - 8" Axle		
CO1010	1968-69	Power Disc - 8" Axle		
CO1011	1968-69	Power Disc - 9" Axle - 28 Spline		
CO1012	1968-69	Power Disc - 9" Axle - 31 Spline		
CO1013	1970	Standard Drum		
CO1014	1970	Power Drum		
CO1015	1970	Power Disc		

## MERCURY

CO1018	1971-72	Power Disc (Before July 1972)
CO1016	1971-73	Standard Drum
CO1017	1971-73	Power Drum
CO1020	1972-73	Power Disc (After July 1972)
TB1018	1983-84	Non V8 Motors
TB1026	1983-84	With V8 Motors
CO1021	1985-86	6 Cylinder
CO1025	1985-86	V8
CO1019	1987-88	Power Disc - V8
CO1026	1987-88	Non V8 Motors

Rubber Brake Hose			Cougar	
Part No.	Year	Description	O.E. Steel	Stainless Steel
RH7002	1966-67	Front Disc Flex Hose - 7/16" Inlet		
RH7006	1967-69	Rear Flex Hose - 28 Spline		
RH7008	1967-70	Front Drum Flex Hose		
RH7011	1968-69	Rear Flex Hose - 31 Spline - Big Block		
RH7004	1968-70	Left Front Flex Hose - Disc		
RH7005	1968-70	Right Front Flex Hose - Disc		
RH7012	1971-73	Front Drum Flex Hose		
RH7015	1971-73	Left Front Flex Hose - Disc		
RH7016	1971-73	Right Front Flex Hose - Disc		
RH7014	1972-73	Rear Flex Hose		

Fuel - Pump To Carburetor Line			Cougar	
Part No.	Year	Description	O.E. Steel	Stainless Steel
MUC1007	1967-68	289 CID - 2 Barrel and 4 Barrel		
MUC1012	1968-70	302 CID and 351W - 2 Barrel		
MUC1013	1968-70	302 CID - 4 Barrel		
MUC1014	1968-70	351W 4 Barrel		
MUC1015	1968-70	428 & 390 CID - 4 Barrel		
MUC1016	1969-70	Boss 302 CID		
MUC1018	1970-73	351C - 2 Barrel		
MUC1019	1970-73	351C 4 Barrel		

Fuel - Tank to Pump Line			Cougar	
Part No.	Year	Description	O.E. Steel	Stainless Steel
COF1014	1967	V8 Early 5/16" (1 Pc.) - Runs Down Tunnel		
COF1015	1967	Early 6 Cylinder (2 Pc.)		
COF1001	1967-68	V8 (Late 1967 & All 1968) 5/16" (2 Pc.) - Runs Down Rocker		
COF1002	1967-68	V8 (Late 1967 & All 1968) 3/8" (2 Pc.) - Runs Down Rocker		
COF1008	1967-70	6 Cylinder - (2 Pc.)		
COF1009	1967-70	6 Cylinder California emissions 5/16" (2 Pc.)		
COF1010	1967-70	6 Cylinder California emission - 3/8"		
COF1011	1968	V8-428CJ - Stagger Rear Shock		
COF1003	1969-70	(2 Pc.)		
COF1012	1969-70	V8 - 3/8" (2 Pc.)		
COF1013	1969-70	V8 - 3/8" (2 Pc.) w/ Factory Rear Sway Bar		
COF1005	1971-73	(2 Pc.)		
COF1006	1971-73	5/16"		

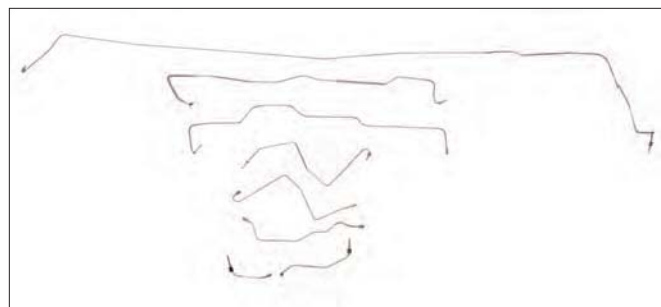

Fuel - Vapor Line			Cougar	
Part No.	Year	Description	O.E. Steel	Stainless Steel
COV1001	1970-73	5/16"		

Transmission Lines (Sold In Pairs)			Cougar	
Part No.	Year	Description	O.E. Steel	Stainless Steel
MUT1007	1967-68	C-6 - V8 - Early 1968		
MUT1005	1967-70	C-4 - 6 Cylinder		
MUT1006	1967-70	C-4 - V8		
MUT1008	1968-70	C-6 - V8 - Late 1968		
MUT1009	1969-70	351W - FMX - V8 - Heavy Duty Cooling		
MUT1017	1970	351C - FMX - V8		
MUT1018	1970	C-6 - Big Block - Early 1970		
MUT1019	1970	C-6 - Big Block - Late 1970 - 428 CJ		
MUT1010	1971-73	C-4 - V8		
MUT1011	1971-73	C-6 - V8		
MUT1012	1971-73	FMX - V8		

Transmission Modulator Line			Cougar	
Part No.	Year	Description	O.E. Steel	Stainless Steel
MUM1005	1967-69	V8 - C4		
MUM1006	1967-70	V8 - C6		
MUM1012	1969-70	351 CID - FMX		
MUM1014	1971	V8 - 429 CID - C6 Automatic Transmission		
MUM1007	1971-73	V8 - C4		
MUM1008	1971-73	V8 - C6		
MUM1013	1972-73	FMX Transmission		
MUM1015	1973	351 C - 4 Barrel - C-6 Transmission		

Choke Tube			Cougar	
Part No.	Year	Description	O.E. Steel	Stainless Steel
MUK1001	1967-68	289 CID - 2 Barrel or 4 Barrel (2 Pc.)		
MUK1003	1967-68	390 CID - 4 Barrel (2 Pc.)		
MUK1005	1968-69	302 - 4 Barrel (2 Pc.)		
MUK1006	1968-69	428 CID - 4 Barrel		
MUK1001	1968-73	302 CID - 2 Barrel (2 Pc.)		
MUK1005	1968-73	302 - 4 Barrel (2 Pc.)		
MUK1008	1969-70	351W - 2 Barrel - Enter Through Bottom of Choke Housing (2 Pc.)		
MUK1009	1969-70	351W - 4 Barrel - Enter Through Side of Choke Housing (2 Pc.)		
MUK1011	1970-73	351C - 2 Barrel (2 Pc.)		
MUK1012	1970-73	351C - 4 Barrel (2 Pc.)		

# JEEP

## JEEP

### Complete Brake Line Kit

Part No.	Year	Description	Jeep Early & Misc.	
			O.E. Steel	Stainless Steel
JE1037	1946-49	CJ2a (1946-49)		
JE1047	1949	Willys Pick up 4WD		
JE1048	1950	Willys Pick up 4WD		
JE1048	1950-52	Truck Willys 4WD 3500		
JE1042	1955	Wagon 4WD		
JE1059	1962-65	Willys Station Wagon 4WD		
JE1041	1963	CJ5		
JE1046	1967	M715 (7 pc.)		
JE1001	1967-68	CJ5 Standard Drum - (12 Pc.)		
JE1062	1967-71	Gladiator 4WD - Power Brake		
JE1024	1969	Wagoneer (10 Pc.) Brake Line Kit, (4 Pc.) Vacuum Line Set		
JE1033	1969-71	CJ5 Standard Drum - (12 Pc.)		
JE1073	1970-71	Gladiator Standard Brake		
JE1039	1971	Truck - J10		
JE1004	1972-73	CJ5 without Power		
JE1055	1973	CJ5 304 CID Engine		
JE1015	1974-75	CJ5 without Power		
JE1026	1976-79	QuadraTrac - Power Drum		
JE1027	1976-79	QuadraTrac - Standard Disc		
JE1028	1976-79	QuadraTrac - Power Disc		
JE1029	1976-79	QuadraTrac - Standard Drum		
JE1071	1976-79	J-10 Shortbed		
JE1072	1976-79	J-20 Shortbed		
JE1002	1976-80	CJ5 Standard Drum		
JE1005	1976-80	CJ7 Standard Disc		
JE1006	1976-80	CJ5 Power Drum		
JE1007	1976-80	CJ7 Standard Drum		
JE1008	1976-80	CJ7 Power Drum		
JE1009	1976-80	CJ7 Power Disc		
JE1019	1976-80	CJ5 Standard Disc		

JE1021	1976-80	CJ5 Power Disc
JE1031	1978	Truck - J10
JE1054	1981	2 Door Widetrack
JE1003	1981-82	CJ7 Standard Disc
JE1014	1981-82	CJ7 Power Disc
JE1034	1981-82	QuadraTrac - Power Disc
JE1035	1981-82	Scrambler Manual Disc
JE1036	1981-82	Scrambler Power Disc
JE1038	1981-82	QuadraTrac - Manual Disc
JE1023	1981-83	CJ5 Standard Disc
JE1025	1981-83	CJ5 Power Disc
JE1057	1981-83	Wagoneer Power Disc
JE1057	1981-83	Cherokee With Narrow Track Power Disc
JE1010	1983-86	CJ7 Standard Disc
JE1011	1983-86	CJ7 Power Disc
JE1044	1983-86	CJ8 Manual Disc
JE1045	1983-86	CJ8 Power Disc
JE1032	1984-88	Wagoneer Power Disc
JE1040	1984-89	Cherokee With Dana 35 Axle
JE1049	1986-89	Comanche With Dana 35 Axle
JE1065	1987-90	Cherokee With Dana 44 Axle
JE1066	1987-90	Comanche With Dana 44 Axle
JE1030	1987-95	Wrangler Power Disc without ABS
JE1056	1993-95	Wrangler With ABS
JE1053	1995-96	Wrangler Non ABS
JE1050	1996	Grand Cherokee Laredo With ABS
JE1043	1997-06	Wrangler TJ Non ABS
JE1051	1997-06	Wrangler With ABS
JE1067	1997-06	Wrangler With ABS - With Rear Disc - Dana 44 Axle (9 Pc.)
JE1068	1997-06	Wrangler Without ABS - With Rear Drum - Dana 44 Axle (9 Pc.)
JE1069	1997-06	Wrangler With ABS - With Rear Drum - Dana 44 Axle (9 Pc.)
JE1052	1999	Cherokee Non ABS 4WD - 4.0 Liter Motor
JE1070	1999-04	Grand Cherokee (8 Pc.) Front to rear made in 2 pieces for easy install
JE1074	2003-06	Wrangler Rubicon with Dana 44 Axle - Non ABS - Rear Disc

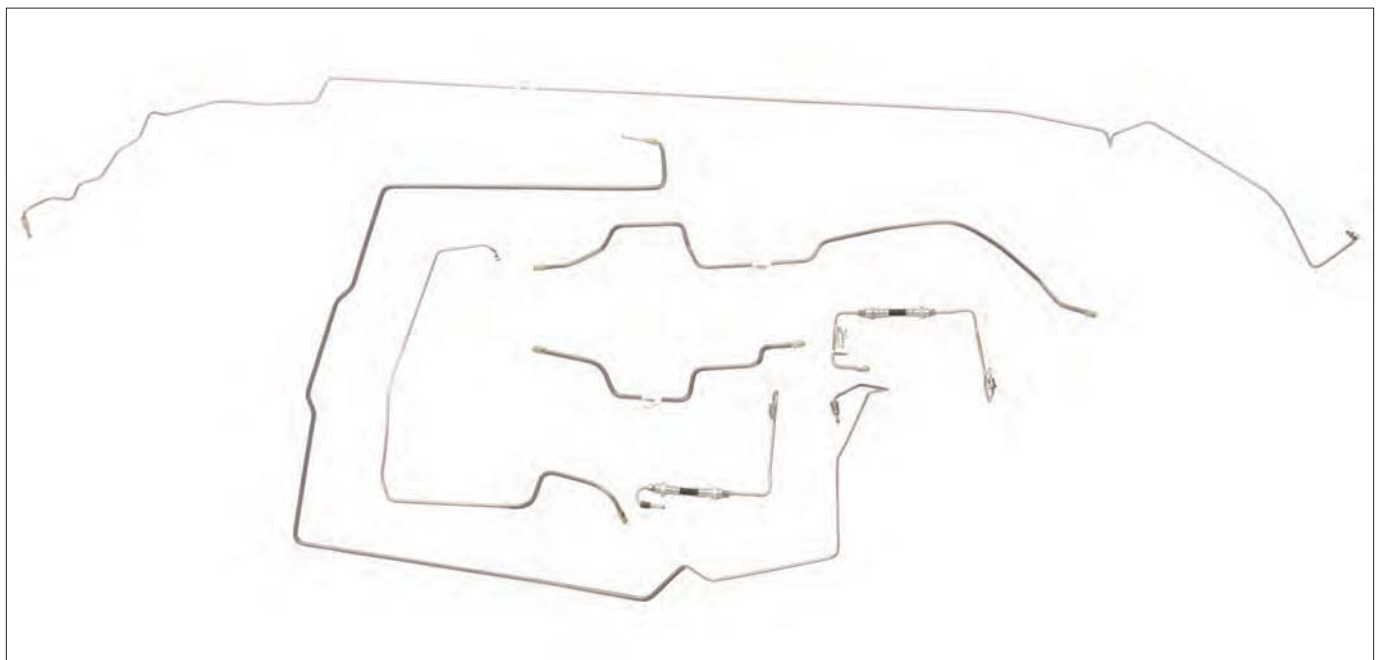

# JEEP

## Miscellaneous & Other Lines Jeep Early & Misc.

Part No.	Year	Description	O.E. Steel	Stainless Steel
JEO1001	1963	CJ5 Manifold Vacuum line		
JEO1002	1963	CJ5 Vacuum Pump Line		
JEO1003	1967	Truck - M-715 Vacuum Line Set (14 Pc.)		
JEO1005	1976-79	CJ7 Quadratrak Lock Up Lines - V8		

## Fuel - Pump To Carburetor Line Jeep Early & Misc.

Part No.	Year	Description	O.E. Steel	Stainless Steel
JEC1003	1963	CJ5		
JEC1002	1966-69	CJ5 V6 - 255 CID - Inline Filter (2 Pc.)		
JEC1006	1967	M715 (2 Pc.)		
JEC1008	1968	Wagoneer 232 CID 6 Cylinder - (1PC.)		
JEC1009	1972-75	304 CID Engine		
JEC1004	1973	CJ5 258 CID - 6 Cylinder - 2 Barrel		
JEC1001	1976-81	CJ7 304 - 360 - 401-2V (2 Pc.)		
JEC1010	1976-81	CJ7 6 Cylinder - (3 Pc.)		
JEC1005	1985	CJ7 6 Cylinder - (3 Pc.)		

## Fuel - Tank To Pump Line Jeep Early & Misc.

Part No.	Year	Description	O.E. Steel	Stainless Steel
JEF1012	1955	Willys 4WD		
JEF1013	1963	Willys 4WD		
JEF1007	1966-71	CJ5 6 Cylinder - Front Section over Engine		
JEF1014	1967	M715 (3 Pc.)		
JEF1017	1968	Wagoneer 232 CID 6 Cylinder (3 Pc.)		
JEF1009	1971	Truck - J10 (3 Pc.)		
JEF1011	1973	CJ5 6 Cylinder		
JEF1001	1976-81	CJ7 6 Cylinder		
JEF1002	1976-81	CJ5 6 Cylinder		
JEF1004	1976-81	CJ7 8 Cylinder		
JEF1006	1976-81	CJ5 8 Cylinder		
JEF1019	1976-81	CJ5 4 Cylinder		
JEF1018	1977	CJ5 304 CID V8		
JEF1010	1978	Wagoneer (2 Pc.)		
JEF1003	1982-86	CJ7 6 Cylinder		
JEF1016	1982-86	CJ8		
JEF1021	1987-91	4.0 Liter - Non fuel Injected		
JEF1008	1988	Wagoneer 5/16"		
JEF1015	1994	YJ (2 Pc.)		
JEF1020	1999	Wrangler 4.0 Liter		

## Fuel - Return Line Jeep Early & Misc.

Part No.	Year	Description	O.E. Steel	Stainless Steel
JER1007	1966-71	CJ5 6 Cylinder - Front Section over Engine		
JER1001	1976-81	CJ7 6 Cylinder		
JER1002	1976-81	CJ5 6 Cylinder		
JER1004	1976-81	CJ7 8 Cylinder		
JER1006	1976-81	CJ5 8 Cylinder		
JER1011	1977	CJ5 304 CID V8		
JER1009	1978	Wagoneer (2 Pc.)		
JER1003	1982-86	CJ7 6 Cylinder		
JER1008	1988	Wagoneer 4WD 1/4"		
JER1010	1994	YJ		

## Fuel - Vapor Line Jeep Early & Misc.

Part No.	Year	Description	O.E. Steel	Stainless Steel
JEV1001	1976-81	CJ7 6 Cylinder		
JEV1002	1976-81	CJ5 6 Cylinder		
JEV1004	1976-81	CJ7 Cylinder		
JEV1005	1976-81	CJ5 8 Cylinder		
JEV1003	1982-86	CJ7 6 Cylinder		
JEV1010	1982-86	CJ8 1982 1983 1984 1985 1986		
JEV1007	1987	Cherokee Sport		
JEV1008	1987-91	Wrangler 4.0 6 Cylinder Non Fuel Injected		
JEV1006	1989	Wrangler 4.2 Liter - 6 Cylinder		
JEV1011	1999	Wrangler 4.0 Liter		
JEV1009	2004	Grand Cherokee		

## Transmission Lines (Sold In Pairs) Jeep Early & Misc.

Part No.	Year	Description	O.E. Steel	Stainless Steel
JEO1004	1973	CJ5 Vacuum Advance Line		
JET1002	1976-79	CJ5 V8 - T-400		
JET1001	1981-86	CJ7 6 Cylinder		
JET1001	1981-86	CJ8 Scrambler 6 Cylinder		
JET1004	1988-89	Wrangler 4.2 Liter - Straight Cylinder		
JET1005	1998	Wrangler 4		
JET1006	1999-04	Cherokee Sport 4WD 4.0 Liter Motor		

## Hydraulic Clutch Line Jeep Early & Misc.

Part No.	Year	Description	O.E. Steel	Stainless Steel
JEH1001	1988	Wrangler Clutch Line		

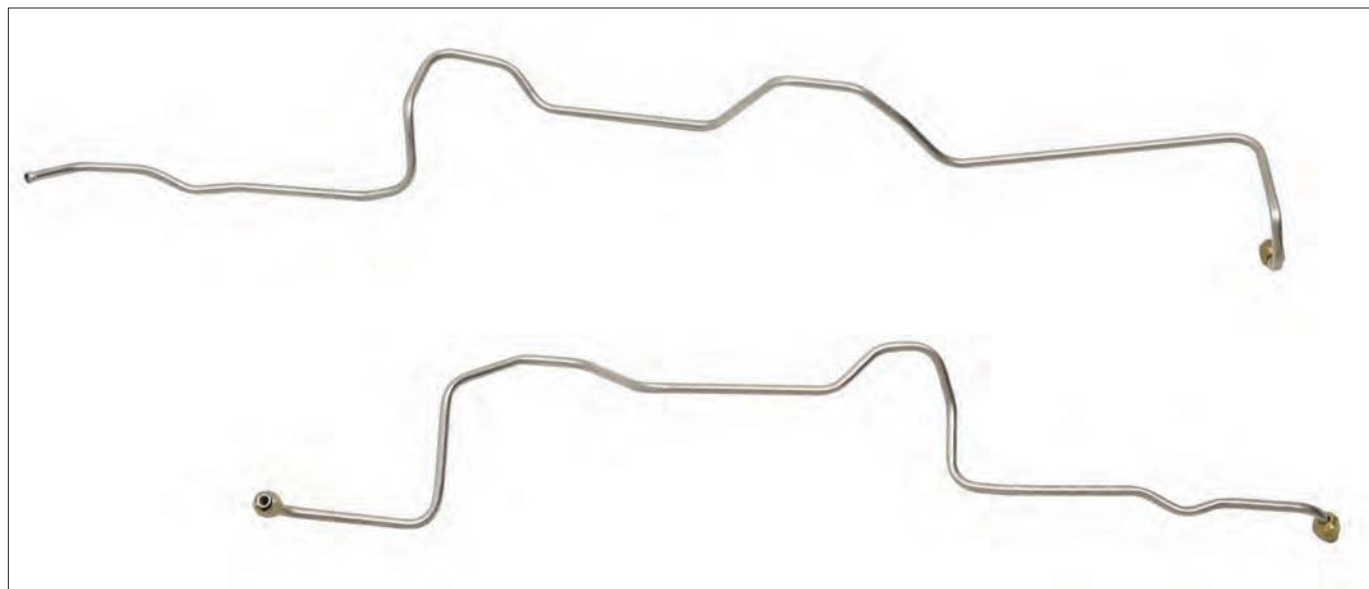

# OLDSMOBILE

## OLDSMOBILE EARLY & MISC.

### Complete Brake Line Kit Oldsmobile Early & Misc.

Part No.	Year	Description	O.E. Steel	Stainless Steel
OL1030	1935-36	All Models 6 Cylinder		
OL1028	1937-38	L-38		
OL1026	1940	Model 90		
OL1033	1946-47	98		
OL1001	1946-48	Series 60		
OL1013	1949	Delta 88 Deluxe Club Coupe		
OL1003	1950	88 Club Coupe Convertible		
OL1034	1950	98		
OL1020	1951	98		
OL1009	1953	98		
OL1019	1954	98		
OL1011	1954	Delta 88 2 Door		
OL1005	1956	Delta 88		
OL1005	1956	98		
OL1010	1956	98 Convertible		
OL1012	1957	Delta 88 2 Door		
OL1016	1957	Delta 88 4 Door		
OL1025	1957	88 Super		
OL1025	1957	98		
OL1015	1958	88 and 98 4 Door		
OL1027	1961-64	98 Power Drum		
OL1006	1965-66	98 Convertible		
CU1006	1966	Skylark Hardtop - Power Drum - V8		
CU1008	1966	Skylark Convertible - Power Drum - V8		
OL1022	1967	Vista Cruiser		
OL1029	1967	Toronado Power Drum		
GLR1003	1967	Skylark Hardtop		
IB1038	1971-73	Delta 88 Hardtop - Power Disc		
IB1040	1971-73	Delta 88 Convertible - Power Disc		
IB1061	1974-76	88 Convertible Power Disc		
OL1008	1976-84	98 2 Door		
OL1031	1976-84	Wagon Power Disc		

### Caliper Inlet Lines & Transfer Tubes (Sold in Pairs) Oldsmobile Early & Misc.

Part No.	Year	Description	O.E. Steel	Stainless Steel
TBD1001	1967-69	Toronado Disc Caliper Transfer Tube		

### Fuel - Pump To Carburetor Line Oldsmobile Early & Misc.

Part No.	Year	Description	O.E. Steel	Stainless Steel
OLC1013	1938	Coupe 6 Cylinder		
OLC1001	1946	All Models 5/16"		
OLC1007	1951	98		
OLC1005	1955	98 324 - 4 Barrel		
OLC1006	1956	98		
OLC1002	1961	All Models 394 CID - Quadrajets (2 Pc.)		
OLC1008	1963	Starfire 394 CID w/ A/C		
OLC1014	1966	Toronado 425 CID		
CUC1004	1969	98 455 CID - Quadrajets		
CUC1005	1969	98 400 CID - Quadrajets		
CUC1004	1973	Delta 88 - Royale 455 CID		

### Fuel - Tank To Pump Line Oldsmobile Early & Misc.

Part No.	Year	Description	O.E. Steel	Stainless Steel
OLF1011	1938	Coupe 6 Cylinder		
OLF1002	1946	Series 78		
OLF1003	1950	Delta 88 Convertible - 5/16" (2 Pc.)		
OLF1004	1953	98		
OLF1005	1956	98		
OLF1006	1957	88 Super 4 Door 3/8"		
OLF1007	1957	88 Super 2 Door 3/8"		
OLF1008	1958	Delta 88 Convertible		
OLF1009	1958	98 Convertible		
OLF1010	1959	98 Convertible		
OLF1012	1964	98 2 Door Hardtop - 394 CID - (3 Pc.)		
CTF1089	2000	Bravada 4WD 4.3 V6 Engine		

### Fuel - Return Line Oldsmobile Early & Misc.

Part No.	Year	Description	O.E. Steel	Stainless Steel
OLR1001	1958	All Models		
CTR1067	2000	Bravada 4WD 4.3 V6 Engine		

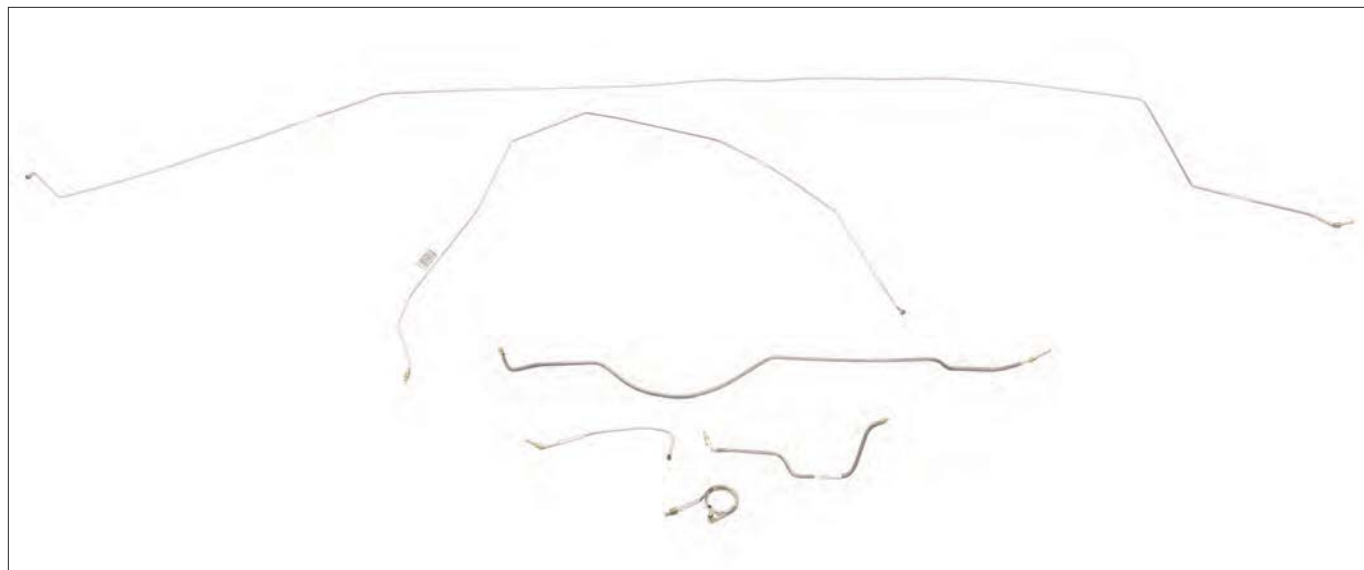

# OLDSMOBILE

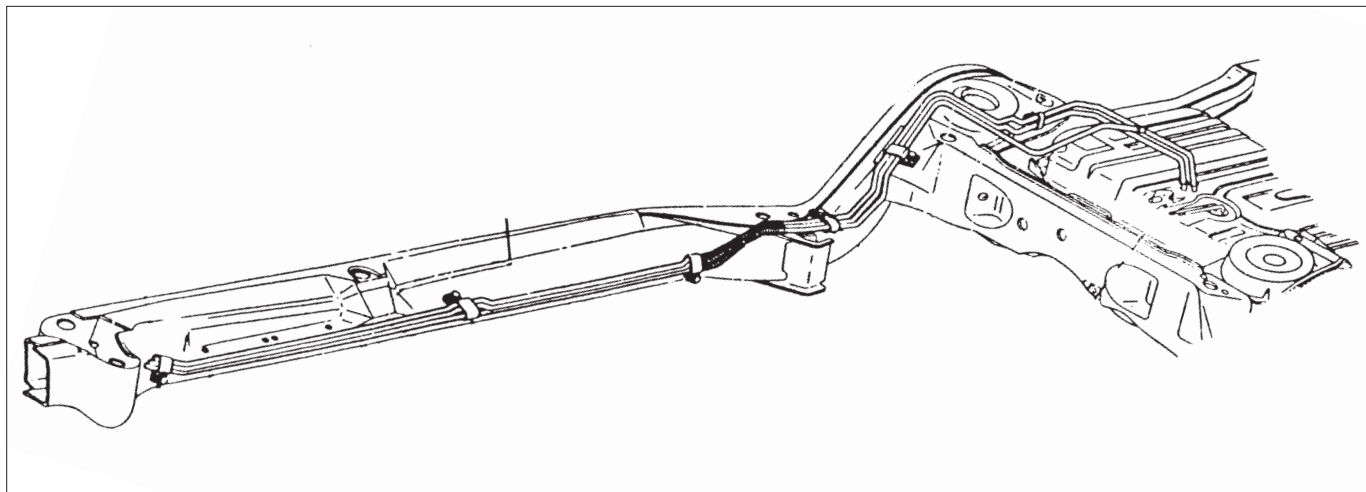

Fuel - Vapor Line			Oldsmobile Early & Misc.
Part No.	Year	Description	O.E. Steel    Stainless Steel
CTV1060	2000	Bravada 4WD 4.3 V6 Engine	

Fuel - Vent Line			Oldsmobile Early & Misc.
Part No.	Year	Description	O.E. Steel    Stainless Steel
OLV1001	1964-66	98 Tank Vent Line	

Transmission Lines (Sold In Pairs)			Oldsmobile Early & Misc.
Part No.	Year	Description	O.E. Steel    Stainless Steel
OLT1005	1956	98	
OLT1006	1957	Delta 88	
OLT1004	1967	Vista Cruiser Power Glide	
OLT1002	1969	98 T-400	
OLT1003	1970	Toronado T-400	
OLT1007	1984	98 200 R-4	

Choke Tube			Oldsmobile Early & Misc.
Part No.	Year	Description	O.E. Steel    Stainless Steel
OLK1007	1951	98 Choke Tube	
OLK1004	1955	98 324 - 4 Barrel - Choke Tube	
CUK1003	1962	F-85 4 Barrel (2 Pc.)	

Miscellaneous & Other Lines			Oldsmobile Early & Misc.
Part No.	Year	Description	O.E. Steel    Stainless Steel
OLO1003	1938	Coupe 6 Cylinder - Vacuum Line	
OLO1002	1938	Coupe 6 Cylinder - Wiper Line	
OLO1004	1946	All Models Fuel - Pump to Wiper Vacuum	
OLO1014	1946	Series 78 Wiper Vacuum	
OLO1006	1951	98 Distributor Vacuum Line	
OLO1007	1951	98 Pump to Vacuum Motor	
OLO1015	1953	98 Vacuum Line	
OLO1008	1955	88 Super Brake Booster Vacuum Line	
OLO1009	1956	98 Pump to Wiper Motor	
OLO1010	1956	98 Pump to Carburetor - Vacuum Line	
OLO1011	1956	98 Intake to Carburetor Vacuum	
OLO1012	1956	98 Power Steering Line	
OLO1013	1956	98 Brake Booster Vacuum Line	
OLO1005	1969-70	98 455 CID - Brake Booster Vacuum Line	
OLO1001	1984	98 (7 Pc.) Power Top/ Window Lines	

## CUTLASS / 442

Complete Brake Line Kit			Cutlass / 442
Part No.	Year	Description	O.E. Steel    Stainless Steel
SG1002	1964-65	Cutlass Hardtop - Standard Drum - 6 Cylinder	
SG1003	1964-65	Cutlass Hardtop - Power Drum - 6 Cylinder	
SG1004	1964-65	Cutlass Convertible - Standard Drum - 6 Cylinder	
SG1005	1964-65	Cutlass Convertible - Power Drum - 6 Cylinder	
SG1006	1964-65	Hardtop - Standard Drum - V8	
SG1008	1964-65	Convertible - Standard Drum - V8	
SG1009	1964-65	Hardtop - Power Drum - V8	
SG1036	1964-65	Convertible - Power Drum - V8	
CU1003	1966	442 Convertible - Standard Drum - V8	
CU1005	1966	442 Hardtop - Standard Drum - V8	
SG1010	1966	Cutlass Only - Hardtop - Standard Drum - 6 Cylinder	
SG1011	1966	Cutlass Only - Hardtop - Power Drum - 6 Cylinder	
SG1013	1966	Cutlass Only - Convertible - Standard Drum - 6 Cylinder	
SG1037	1966	Cutlass Only - Convertible - Power Drum - 6 Cylinder	
CU1009	1967	Cutlass Only - Hardtop - Standard Drum - 6 Cylinder	
CU1010	1967	Cutlass Only - Hardtop - Power Drum - 6 Cylinder	
CU1012	1967	Cutlass Only - Hardtop - Power Disc - 6 Cylinder	
CU1013	1967	Cutlass Only - Convertible - Standard Drum - 6 Cylinder	
CU1014	1967	Cutlass Only - Convertible - Power Drum - 6 Cylinder	
CU1016	1967	442 Only - Convertible - Power Disc - V8	
CU1040	1967	442 Only - Hardtop - Standard Drum - V8	
CU1041	1967	442 Only - Hardtop - Power Drum - V8	
CU1042	1967	442 Only - Hardtop - Power Disc - V8	
CU1043	1967	442 Only - Convertible - Standard Drum - V8	
CU1044	1967	442 Only - Convertible - Power Drum - V8	
CU1045	1967	Cutlass Convertible - Power Disc - 6 Cylinder	
CU1033	1968-69	Hardtop - Standard Disc	
SG1022	1968-69	Hardtop - Standard Drum	
SG1023	1968-69	Hardtop - Power Drum	
SG1024	1968-69	Hardtop - Power Disc	
SG1025	1968-69	Convertible - Standard Drum	
SG1026	1968-69	Convertible - Power Drum	
SG1027	1968-69	Convertible - Power Disc	
CU1023	1970	442 Only - Hardtop - Standard Disc	
CU1024	1970	442 Only - Convertible - Standard Disc	

# OLDSMOBILE

Cont. from previous page

SG1028	1970	Hardtop - Power Disc
SG1029	1970	Convertible - Power Disc
SG1030	1970	442 Hardtop - Standard Drum
SG1031	1970	442 Hardtop - Power Drum
SG1033	1970	442 Convertible - Standard Drum
SG1034	1970	442 Convertible - Power Drum
CU1025	1971-72	442 Only - Hardtop - Standard Drum
CU1026	1971-72	442 Only - Hardtop - Power Drum
CU1028	1971-72	442 Only - Convertible - Standard Drum
CU1029	1971-72	442 Only - Convertible - Power Drum
SG1032	1971-72	Hardtop - Power Disc
SG1035	1971-72	Convertible - Power Disc
CU1031	1973-77	442 Only - Hardtop Power Disc
CE1053	1973-77	Cutlass (Non 442) Power Disc
CE1054	1978-81	Cutlass Only - Power Disc
BU1029	1982-87	Cutlass only - Power Disc
CU1046	1988-93	Cutlass Supreme - Non - ABS
BU1047	1988-94	Cutlass Supreme With ABS

### Caliper Inlet Lines & Transfer Tubes (Sold in Pairs) Cutlass / 442

Part No.	Year	Description	O.E. Steel	Stainless Steel
CUD1001	1967	Disc Inlet Line - Inlet: 3/8" and 3/8"		
GLD1001	1967	Disc Inlet Line - Inlet: 7/16" and 1/2"		
GLD1003	1968	Disc (Inlet 7/16" and 1/2")		

### Fuel - Pump To Carburetor Line Cutlass / 442

Part No.	Year	Description	O.E. Steel	Stainless Steel
CUC1007	1965	400 CID - Quadrajets With Air Conditioning		
CUC1001	1966	442 Only - Tri-Power (4 Pc.)		
CUC1002	1968-72	350 CID - Quadrajets		
CUC1005	1968-72	400 CID - Quadrajets		
CUC1003	1970-72	442 Only - 455 CID - Quadrajets (2 Pc.)		
CUC1004	1970-72	455 CID Rochester Quadrajets		
CUC1006	1977-83	260 CID 307 CID - Quadrajets		
CUC1008	1985	Cutlass Only - 307 CID 4 Barrel Carburetor		

### Fuel - Tank To Pump Line Cutlass / 442

Part No.	Year	Description	O.E. Steel	Stainless Steel
CUF1001	1964-67	Cutlass Only - Hardtop - 5/16"		
CUF1002	1964-67	Cutlass Only - Convertible - 5/16"		



# OLDSMOBILE

CUF1003	1964-67	442 Only - Hardtop - 3/8"
CUF1005	1968-72	442 Only - Hardtop (2 Pc.)
CUF1006	1968-72	442 Only - Convertible (2 Pc.)
CUF1007	1973-77	442 Only - Hardtop
CEF1013	1978-88	3.8 Liter- V6 - Buick Engine & 307 CID - V8 k Oldsmobile Engine
CUF1011	1988-91	442 3.1 Liter - 3/8"

Fuel - Return Line			Cutlass / 442	
Part No.	Year	Description	O.E. Steel	Stainless Steel
CUR1001	1964-67	Hardtop		
CUR1002	1964-67	442 Only - Convertible		
CUR1005	1968-72	442 Only - Hardtop (2 Pc.)		
CUR1006	1968-72	442 Only - Convertible - Type 1 Jogs Around Frame (2 Pc.)		
CUR1009	1971-72	442 Only - Convertible - Type 2 Straight (2 Pc.)		
CUR1007	1973-77	442 Only - Hardtop (1 Pc.)		
MCR1002	1978-87	442 V8 Engine		

Fuel - Vapor Line			Cutlass / 442	
Part No.	Year	Description	O.E. Steel	Stainless Steel
CUV1001	1971-72	442 Only - Hardtop (1 Pc.)		
CUV1002	1971-72	Convertible (1 Pc.)		
CUV1003	1973-77	Hardtop (2 Pc.)		
MCV1002	1978-88	Cutlass Without AC		

Fuel - Stand Pipe Set			Cutlass / 442	
Part No.	Year	Description	O.E. Steel	Stainless Steel
BUS1005	1970	Cutlass (3 Pc.)		
BUS1004	1971-72	442 Vent Set (3 Pc.)		
BUS1004	1971-72	Cutlass Vent Set (3 Pc.)		
BUS1001	1978-87	Cutlass Only - (3 Pc.)		
BUS1002	1988-91	Cutlass Only - Fuel Injected (3 Pc.)		

Transmission Lines (Sold In Pairs)			Cutlass / 442	
Part No.	Year	Description	O.E. Steel	Stainless Steel
CUT1001	1964-65	442 Only - Powerglide and T-350		
CUT1002	1966-67	442 Only - T-400		
CUT1003	1968-71	442 Only - T-350 and T-400		
CUT1004	1972	442 Only - T-350 and T-400		
CUT1005	1973-77	442 Only - T-350 and T-400		
CUT1007	1978-79	442 Only - T-350		
CUT1008	1984-87	442 Only - 307 CID - V8		
CUT1009	1984-87	Cutlass Only - 6 Cylinder		

Transmission Modulator Line			Cutlass / 442	
Part No.	Year	Description	O.E. Steel	Stainless Steel
CUM1002	1964-65	442 Only - T-400		
CUM1001	1965	Power Glide		
CUM1007	1967	T-400 - Side Modulator		
CUM1009	1967	442 Only - With Jetaway Transmission		
CUM1003	1968-72	442 Only - T-400 - Side Modulator		
CUM1004	1968-72	442 Only - T-350		
CUM1005	1973-77	442 Only - T-350		
CUM1008	1973-77	442 Only - T-400		

Choke Tube			Cutlass / 442	
Part No.	Year	Description	O.E. Steel	Stainless Steel
CUK1001	1970-72	442 Only - 455 CID - Automatic Transmission (2 Pc.)		
CUK1002	1970-72	442 Only - 455 CID - Standard Transmission (2 Pc.)		
CUK1004	1978	Cutlass Only - 260 CID (2 Pc.)		
CUK1005	1984	Cutlass Only - (2 Pc.)		

Miscellaneous & Other Lines			Cutlass / 442	
Part No.	Year	Description	O.E. Steel	Stainless Steel
CUO1001	1970-72	442 Only - 455 CID - Brake Booster Vacuum		
CUO1002	1973-77	Brake Booster Vacuum Line		
CUO1003	1974	Cutlass Only - 350 CID No Air Conditioning - Power Steering Lines		

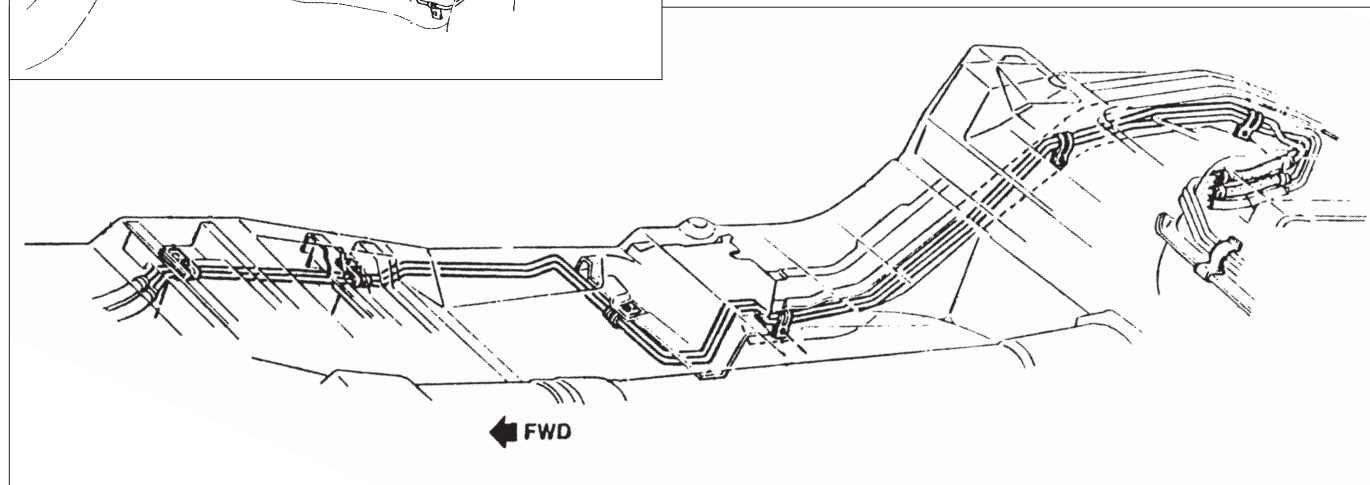
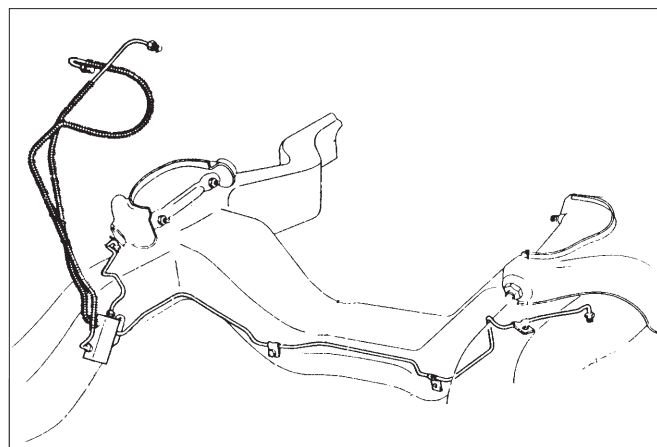

# PONTIAC

## PONTIAC EARLY & MISC.

### Complete Brake Line Kit

Part No.	Year	Description	Pontiac Early & Misc.	
			O.E. Steel	Stainless Steel
PO1001	1940	Series 26		
PO1012	1949-52	All Models		
PO1003	1954	Star Chief Hardtop		
PO1004	1955-56	Star Chief Convertible		
PO1028	1955-56	All Models Hardtop		
PO1006	1957	Star Chief		
PO1011	1961-62	Star Chief Power Drum		
PO1015	1961-62	Star Chief Standard Drum		
NV1001	1962-65	Ventura 4 Cylinder and 6 Cylinder Motors		
CU1009	1967	GS Hardtop - Standard Drum - 6 Cylinder		
CU1010	1967	GS Hardtop - Power Drum - 6 Cylinder		
CU1012	1967	GS Hardtop - Power Disc - 6 Cylinder		
CU1013	1967	Convertible - Standard Drum - 6 Cylinder		
PO1014	1970	Grandville Convertible		
PO1018	1971-73	Grandville Convertible		
BU1042	1996	Bonneville With Traction control		
BU1058	1996	Bonneville Without Traction control		

### Fuel - Pump To Carburetor Line

Part No.	Year	Description	Pontiac Early & Misc.	
			O.E. Steel	Stainless Steel
POC1010	1949-51	All Models Carburetor Line		
POC1013	1952			
POC1001	1954	All Models Fuel Line		
POC1011	1955	Star Chief 2 Barrel Carburetor		
POC1004	1957	Star Chief 5/16" and 3/8" (2 Pc.)		
POC1005	1958	All Models Tri-Power (4 Pc.)		

### Fuel - Tank To Pump Line

Part No.	Year	Description	Pontiac Early & Misc.	
			O.E. Steel	Stainless Steel
POF1012	1949-51	All Models		
POF1003	1953	Chieftain 5/16"		
POF1001	1954	All Models Hardtop		
POF1002	1955	All Models Convertible		
POF1020	1955	Star Chief Hardtop 2 door		
POF1016	1957	Star Chief Safari Wagon 3/8"		
POF1007	1958	Chieftain Hardtop and Convertible - 3/8" (2 Pc.)		
POF1013	1962	Chieftain 5/16"		
POF1019	1968	Star Chief Hardtop - 5/16"		
POF1011	1969	Star Chief (2 Pc.)		
POF1017	1970	Grandville Convertible		
POR1002	1970	Grandville Convertible		
GLF1010	1973	Grand Am Hardtop		
GLR1011	1973	Grand Am Chevrolet Motor		
NVF1005	1974	Ventura 3/8" (2 Pc.)		

### Fuel - Vapor Line

Part No.	Year	Description	Pontiac Early & Misc.	
			O.E. Steel	Stainless Steel
POV1001	1970	Grandville Convertible		
NWV1001	1974	Ventura 1974		

### Transmission Lines (Sold In Pairs)

Part No.	Year	Description	Pontiac Early & Misc.	
			O.E. Steel	Stainless Steel
POT1006	1960	Ventura		
GLT1007	1973	Grand Am V8 - T-400		



## PONTIAC

Choke Tube			Pontiac Early & Misc.	
Part No.	Year	Description	O.E. Steel	Stainless Steel
POA1003	1954	All Models Manifold to Carburetor - Choke Tube Set		
POA1011	1954	Star Chief Choke Tube		

Miscellaneous & Other Lines			Pontiac Early & Misc.	
Part No.	Year	Description	O.E. Steel	Stainless Steel
POA1010	1949-51	All Models Oil Line Kit		
POA1016	1949-51	All Models Wiper to Pump		
POA1001	1951-52	All Models Vacuum Line		
POA1018	1951-52	Distributor Vacuum Line		
POA1004	1954	All Models Brake Booster Vacuum Line		
POA1017	1954	All Models Wiper to Pump (2 Pc.)		
POA1005	1955-56	All Models Brake Booster Vacuum Line (2 Pc.)		
POA1006	1955-56	All Models Fuel Pump to Wiper Vacuum Line		

## BONNEVILLE

Complete Brake Line Kit			Bonneville	
Part No.	Year	Description	O.E. Steel	Stainless Steel
PO1006	1957	Convertible		
PO1008	1958	Convertible		
PO1007	1958	Hardtop		
PO1009	1959-60	Hardtop		
PO1010	1959-60	Convertible		
PO1011	1961-62	Power Drum		
PO1015	1961-62	Standard Drum		
PO1023	1963-64	Standard Brake - Wide Saddle		
PO1024	1963-64	Power Brakes - Wide Saddle		
BU1048	1997-99	Without Traction control		
BU1051	1997-99	With Traction control		

Caliper Inlet Lines & Transfer Tubes (Sold in Pairs)			Bonneville	
Part No.	Year	Description	O.E. Steel	Stainless Steel
BUD1003	1997-99	Rear Inlet Lines		

Fuel - Pump To Carburetor Line			Bonneville	
Part No.	Year	Description	O.E. Steel	Stainless Steel
POC1014	1957	347 CID		
POC1012	1959-60	389 CID - Tri-Power - (3 Pc.)		
POC1006	1962			
POC1017	1962	Carb to Filter Line		
POC1015	1964	389 CID - 4 Barrel		
POC1016	1965	389 CID		

Fuel - Tank To Pump Line			Bonneville	
Part No.	Year	Description	O.E. Steel	Stainless Steel
POF1004	1957	Hardtop - 3/8"		
POF1005	1957	Convertible 5/16"		
POF1006	1957	Convertible - 3/8"		
POF1018	1957	Hardtop - 5/16"		
POF1007	1958	Hardtop and Convertible - 3/8" (2 Pc.)		
POF1009	1959	Hardtop and Convertible - 3/8" (2 Pc.)		
POF1014	1962	Hardtop		
POF1008	1971	Convertible - 3/8" (2 Pc.)		
POF1010	1971	Convertible - 3/8" (2 Pc.)		

Fuel - Return Line			Bonneville	
Part No.	Year	Description	O.E. Steel	Stainless Steel
POR1001	1962	4 Door - Hardtop		



Transmission Lines (Sold In Pairs)			Bonneville	
Part No.	Year	Description	O.E. Steel	Stainless Steel
POT1001	1957-59			
POT1002	1963			
POT1004	1964	Super Hydramatic		

Transmission Modulator Line			Bonneville	
Part No.	Year	Description	O.E. Steel	Stainless Steel
POM1001	1965	389 CID		

Choke Tube			Bonneville	
Part No.	Year	Description	O.E. Steel	Stainless Steel
POA1012	1962	Choke Tube Set (2 Pc.)		

Miscellaneous & Other Lines			Bonneville	
Part No.	Year	Description	O.E. Steel	Stainless Steel
POA1007	1957	Brake Booster Vacuum Line (2 Pc.)		
POA1008	1957	Manifold to Vacuum Canister (3 Pc.)		
POA1009	1957	Fuel Pump to Wiper Vacuum Line		

## CATALINA

Complete Brake Line Kit			Catalina	
Part No.	Year	Description	O.E. Steel	Stainless Steel
CN1001	1960	Non-Power		
CN1002	1962	Standard Brake		
CN1004	1962	Power Brake		
CN1010	1963-64	Standard Brake - Narrow Saddle		
CN1012	1963-64	Power Brake - Narrow Saddle		
CN1014	1963-64	Standard Brake - Wide Saddle		
CN1016	1963-64	Power Brake - Wide Saddle		
CN1018	1965	Hardtop - Standard Brake - Narrow Saddle		
CN1019	1965	Convertible - Standard Brake - Narrow Saddle		
CN1020	1965	Hardtop - Power Brake - Narrow Saddle		
CN1021	1965	Convertible - Power Brake - Narrow Saddle		
CN1027	1965	Hardtop - Standard Brake - Wide Saddle		
CN1028	1965	Convertible - Standard Brake - Wide Saddle		
CN1029	1965	Hardtop - Power Brake - Wide Saddle		
CN1030	1965	Convertible - Power Brake - Wide Saddle		
GP1017	1965	Standard Brake		
GP1019	1965	Power Brake		
CN1022	1966	Hardtop - Standard Brake		
CN1023	1966	Convertible - Standard Brake		
CN1024	1966	Hardtop - Power Brake		
CN1025	1966	Convertible - Power Brakes		
GP1021	1966	Standard Brake		
GP1023	1966	Power Brake		

# PONTIAC

## Fuel - Tank To Pump Line Catalina

Part No.	Year	Description	O.E. Steel	Stainless Steel
POF1020	1955	Hardtop 2 door		
CNF1001	1960	(2 Pc.)		
CNF1002	1961-64	Narrow Saddle - 3/8" (1 Pc.)		
CNF1003	1961-64	Wide Saddle - 3/8" (1 Pc.)		
CNF1005	1965	3/8"		
CNF1004	1967	Hardtop		

## Fuel - Return Line Catalina

Part No.	Year	Description	O.E. Steel	Stainless Steel
CNR1002	1962-64	Wide Saddle		
CNR1001	1965	Wide Saddle		

## Transmission Lines (Sold In Pairs) Catalina

Part No.	Year	Description	O.E. Steel	Stainless Steel
CNT1002	1965	Turbo Hydramatic - 389 and 421 CID		
CNT1001	1967	T-350 and T-400- 3/8"		
CNT1003	1968	T-400		

## Transmission Modulator Line Catalina

Part No.	Year	Description	O.E. Steel	Stainless Steel
CNM1001	1968	T-400		

## Choke Tube Catalina

Part No.	Year	Description	O.E. Steel	Stainless Steel
POA1013	1965	Choke Tube - 389 and 421 CID - 2 Barrel (2 Pc.)		
POA1014	1965	Choke Tube - 389 CID and 421 CID - 4 Barrel (2 Pc.)		

## Miscellaneous & Other Lines Catalina

Part No.	Year	Description	O.E. Steel	Stainless Steel
POA1015	1965	Brake Booster Vacuum Line - 389 CID & 421 CID - 2 Barrel & 4 Barrel		

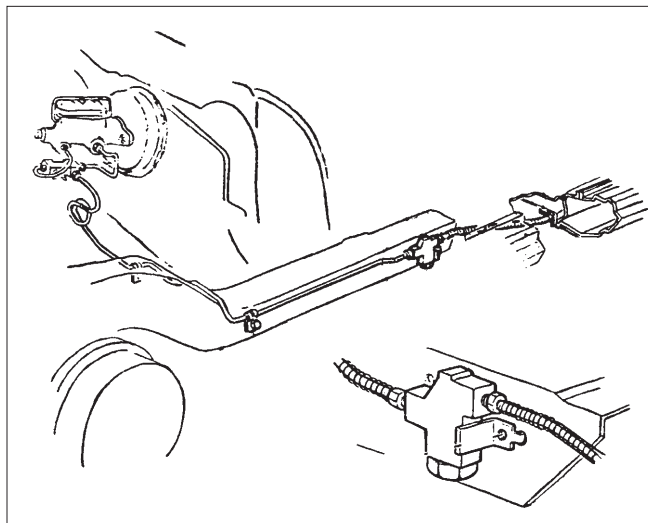

## Transmission Lines (Sold In Pairs) Fiero

Part No.	Year	Description	O.E. Steel	Stainless Steel
POT1007	1984-87	6 Cylinder		
POT1008	1988			

## Hydraulic Clutch Line Fiero

Part No.	Year	Description	O.E. Steel	Stainless Steel
POH1001	1984-87	Clutch Line		
POH1002	1988	Clutch Line		

## FIERO

## Complete Brake Line Kit Fiero

Part No.	Year	Description	O.E. Steel	Stainless Steel
PO1016	1984	6 Cylinder		
PO1025	1985	4 Cylinder		
PO1026	1985-87	6 Cylinder		
PO1027	1988	6 Cylinder		

## Fuel - Return Line Fiero

Part No.	Year	Description	O.E. Steel	Stainless Steel
POR1005	1984-87	4 & 6 Cylinder		
POR1006	1985-88	Fuel - Rail Return Line V6 - 2.8 Liter		
POR1003	1986	Canister to Sending Unit		
POR1007	1987-88	4 Cylinder Fuel Rail Return Line		

## Fuel - Vapor Line Fiero

Part No.	Year	Description	O.E. Steel	Stainless Steel
POV1002	1986	4 Cylinder		
POV1003	1986	6 Cylinder		

## Fuel - Miscellaneous Fiero

Part No.	Year	Description	O.E. Steel	Stainless Steel
POF1023	1984-87	Throttle Body - Fuel Injected - 4 Cylinder - Fuel Rail to Filter		
POF1024	1984-87	Throttle Body - Fuel Injected - 4 Cylinder - Filter to Tank		
POF1025	1985-88	Fuel - Rail to Feed Line V6 - 2.8 Liter		
POF1021	1986	Filter To Sending Unit		
POF1022	1986	Throttle Body Feed Line		
POR1004	1986	Throttle Body Return		
POF1026	1987-88	4 Cylinder		

## FIREBIRD / TRANS AM

## Complete Brake Line Kit Firebird / Trans Am

Part No.	Year	Description	O.E. Steel	Stainless Steel
FB1003	1967-68	Standard Disc - (1 Pc.) Front to Rear		
FB1004	1967-68	Standard Disc - (2 Pc.) Front to Rear		
FB1005	1967-68	Power Disc - (1 Pc.) Front to Rear		
FB1006	1967-68	Power Disc - (2 Pc.) Front to Rear		
FB1007	1967-68	Standard Drum Mono-Leaf Rear Spring		
FB1008	1967-68	Power Drum Mono-Leaf Spring		
FB1014	1969	Power Drum - (1 Pc.) Front to Rear		
FB1015	1969	Standard Disc - (1 Pc.) Front to Rear		
FB1016	1969	Standard Disc - (2 Pc.) Front to Rear		
FB1017	1969	Power Disc - (1 Pc.) Front to Rear		
FB1018	1969	Power Disc - (2 Pc.) Front to Rear		
FB1040	1969	Firebird Standard Drum - (2 Pc. Front to Rear)		
FB1041	1969	Firebird Power Drum (2 Pc. Front to Rear)		
CA1020	1970	Firebird Only - Standard Disc		
CA1021	1970	Firebird Only - Power Disc		
CA1024	1971-74	Standard Disc		
CA1024	1971-74	Trans Am Standard Disc		
CA1025	1971-74	Power Disc		
CA1025	1971-74	Trans Am Power Disc		
CA1026	1975-80	Standard Disc		
CA1026	1975-80	Firebird Standard Disc		
CA1027	1975-80	Power Disc		
CA1027	1975-80	Trans Am Non Z28 - Power Disc		
FB1026	1979	Power Disc - 4 Wheel (WS-6)		
FB1027	1980	Power Disc - 4 Wheel (WS-6)		
FB1031	1981	Power Disc - 4 Wheel (WS-6)		
CA1041	1981	Firebird Only - Standard Disc		

## PONTIAC

CA1042	1981	Power Disc
CA1045	1982-83	Power Disc - Rear Drum
CA1046	1982-83	Power Disc - Rear Disc
CA1047	1984-86	Power Disc - Rear Drum
CA1048	1984-86	Power Disc - Rear Disc
CA1049	1984-86	Power Disc - Rear Drum - 4 and 6 Cylinder

Caliper Inlet Lines & Transfer Tubes (Sold in Pairs)			Firebird / Trans Am	
Part No.	Year	Description	O.E. Steel	Stainless Steel
CAD1001	1967-68			
CAD1003	1967-68	Inlet Size: 7/16" & 1/2"		
CAD1002	1969	Firebird Only - 4 Wheel - Power Disc JL-8		

Fuel - Pump To Carburetor Line			Firebird / Trans Am	
Part No.	Year	Description	O.E. Steel	Stainless Steel
FBC1002	1967	400 CID - 4 Barrel - Except H.O.		
FBC1003	1967	400 CID - 4 Barrel - Inline Filter w/ Return Line (3 Pc.)		
FBC1001	1967-68	400 CID - 326 - 2 Barrel - Quadrajjet (1 Pc.)		
FBC1004	1968	400 CID - 4 Barrel		
FBC1005	1969	4 Barrel - Except Ram Air - IV		
FBC1006	1969	Ram Air - IV - 400 CID (1 Pc.)		
FBC1007	1970	Ram Air - IV - 400 CID (1 Pc.)		
FBC1013	1970	400 CID - 4 Barrel - Non-Ram Air		
FBC1008	1971-74	350 - 2 Barrel		
FBC1009	1971-75	4 Barrel - Except 455 CID - Super Duty		
FBC1010	1973-78	400 CID - Pontiac Motor - 4 Barrel		
FBC1016	1975	Trans-Am Engine - 455 H.O. - Quadrajjet - 3/8"		
FBC1017	1975	Late - 400 CID - 4 Barrel		
FBC1011	1975-79	Oldsmobile 403 CID - 4 Barrel		

FBC1012	1979-81	301 CID - 4 Barrel (1 Pc.)
FBC1014	1979-81	301 CID - Turbo Only (2 Pc.)
CAC1018	1986	305 CID Rochester Quadrajjet

Fuel - Tank To Pump Line			Firebird / Trans Am	
Part No.	Year	Description	O.E. Steel	Stainless Steel
FBF1001	1967-68	5/16" (2 Pc.)		
FBF1002	1967-68	Small Block - 3/8" (2 Pc.)		
FBF1003	1967-68	Big Block - 3/8" (2 Pc.)		
FBF1004	1969	Small and Big Block		
FBF1013	1970-74	455 S.D. (2 Pc.)		
FBF1005	1971-72	350 CID & 400 CID		
FBF1017	1973-76	250 CID Motor - (2 Pc.)		
FBF1012	1977-79	With Oldsmobile Motor - Left Side Route (2 Pc.)		
FBF1007	1977-81	With Pontiac Motor Left Side Route (2 Pc.)		
FBF1010	1977-81	231 CID Motor - Right Side Route (2 Pc.)		
FBF1008	1977-81			
CAF1008	1982-83	V8		
CAF1009	1984-86	V8 - Carbureted only		
FBF1015	1985	Fuel - Injected 2.8 Liter - (2pc.)		
CAF1010	1986-89	V8 Throttle Body - Fuel Injection		
FBF1016	1989	20th Anniv. Turbo T/A Fuel Rail Feed Line		

Fuel - Return Line			Firebird / Trans Am	
Part No.	Year	Description	O.E. Steel	Stainless Steel
FBR1001	1967-68	(1 Pc.)		
FBR1002	1969	(1 Pc.)		
FBR1003	1970-74	Right Side Route (2 Pc.)		
FBR1008	1971-72	Pontiac Motor - Small and Big Block		
FBR1017	1973-74	455 CID Super Duty		
FBR1004	1977-81	With Oldsmobile Motor (2 Pc.)		

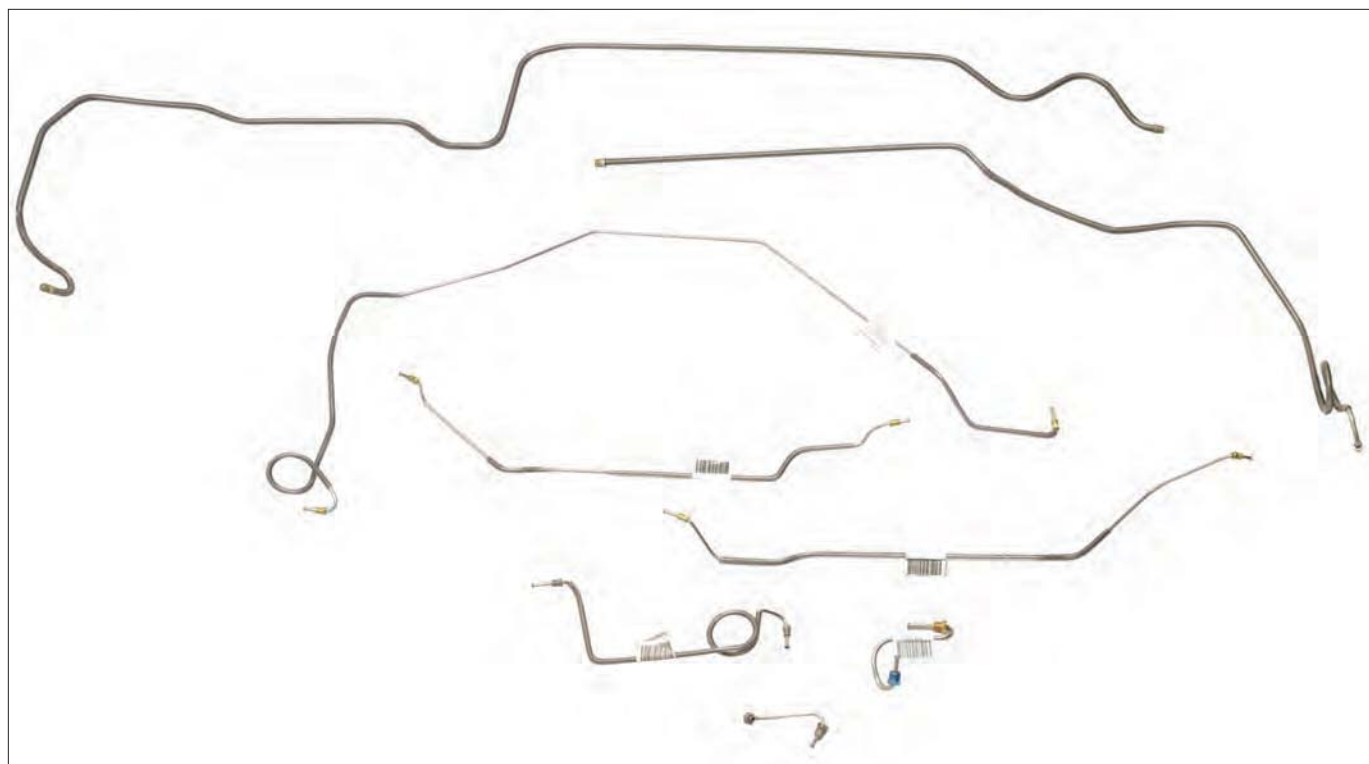

# PONTIAC

Cont. from previous page

FBR1006	1977-81	With Pontiac Motor (2 Pc.)
CAR1004	1982-83	V8 - Carbureted
CAR1008	1984-86	V8 Carbureted Motor
CAR1005	1986-89	V8 - Fuel Injected
CAR1006	1990-91	5/16"
CAR1007	1993-97	All Motors

### Fuel - Vapor Line Firebird / Trans Am

Part No.	Year	Description	O.E. Steel	Stainless Steel
FBV1007	1970	(2 Pc.)		
FBV1001	1972-73	(2 Pc.)		
FBV1002	1977-81	Pontiac Motor		
FBV1004	1977-81	231 CID and 305 CID		
CAV1004	1982-83	V8		
CAV1004	1982-83	Firebird V8		
CAV1009	1982-83	Trans Am V6		
CAV1005	1984-86	Firebird V8 - Carbureted		
CAV1006	1985-89	Firebird V8 TPI Motors		
CAV1008	1993-97	Trans Am All Motors		

### Fuel - Stand Pipe Set Firebird / Trans Am

Part No.	Year	Description	O.E. Steel	Stainless Steel
CAS1001	1970-74	(3 Pc.)		
FBS1002	1977-81	Firebird Without 231 CID or 305 CID Motors (2 Pc.)		

### Fuel - Vent Line Firebird / Trans Am

Part No.	Year	Description	O.E. Steel	Stainless Steel
FBO1004	1969	Crank Case Vent Tube		

### Transmission Lines (Sold In Pairs) Firebird / Trans Am

Part No.	Year	Description	O.E. Steel	Stainless Steel
FBT1001	1967-69	Powerglide & T-350		
FBT1002	1967-69	T-400		
FBT1003	1970-74	T-400 - 1/2" Radiator Inlets		
FBT1004	1970-74	T-400 - 5/8" Radiator Inlets		
FBT1008	1975-77	T-350 and T-400 - V8		
FBT1006	1975-81	T-350 - 6 Cylinder		
FBT1011	1978	700R4		
FBT1007	1979-80	T-400 and T-350		

FBT1010	1988	700R4
FBT1012	1989	25th Anniversary - 3.8 Liter - Turbo 6 Cylinder
CAT1012	1989-92	V8 - 700R4

### Transmission Modulator Line Firebird / Trans Am

Part No.	Year	Description	O.E. Steel	Stainless Steel
FBM1001	1967-69	Powerglide		
FBM1002	1967-69	T-350		
FBM1004	1970-72	T-400 - 2 Barrel		
FBM1005	1973	T-350		
FBM1006	1974	T-400 455 CID Non Super Duty		
FBM1003	1975-81	T-350 with Trans Am Motor (1 Pc.)		

### Choke Tube Firebird / Trans Am

Part No.	Year	Description	O.E. Steel	Stainless Steel
FBK1002	1967-68	326 CID - 2 Barrel - Choke Tubes (2 Pc.)		

### Miscellaneous & Other Lines Firebird / Trans Am

Part No.	Year	Description	O.E. Steel	Stainless Steel
FBO1009	1967	Brake Booster to Manifold - 326 CID - 2 Barrel		
FBO1005	1967-68	Power Steering - Return Line		
FBO1001	1969	Ram Air - IV - Power Steering Cooler Line		
FBO1006	1975	Trans-Am - 455 CID - Brake Booster Vacuum Line		
FBO1010	1978	Brake Booster to Manifold		
FBO1008	1979	403 CID - Power Steering Pressure Hose		
FBO1007	1980	Turbo - WS6 Oil Line		
FBO1012	1988-89	Power Steering Line		

## GRAND PRIX

### Complete Brake Line Kit Grand Prix

Part No.	Year	Description	O.E. Steel	Stainless Steel
CN1002	1962	Standard Brake		
CN1010	1963-64	Standard Brake - Narrow Saddle		
CN1012	1963-64	Power Brake - Narrow Saddle		
CN1014	1963-64	Standard Brake - Wide Saddle		
CN1016	1963-64	Power Brake - Wide Saddle		
GP1017	1965	Standard Brake		
GP1019	1965	Power Brake		

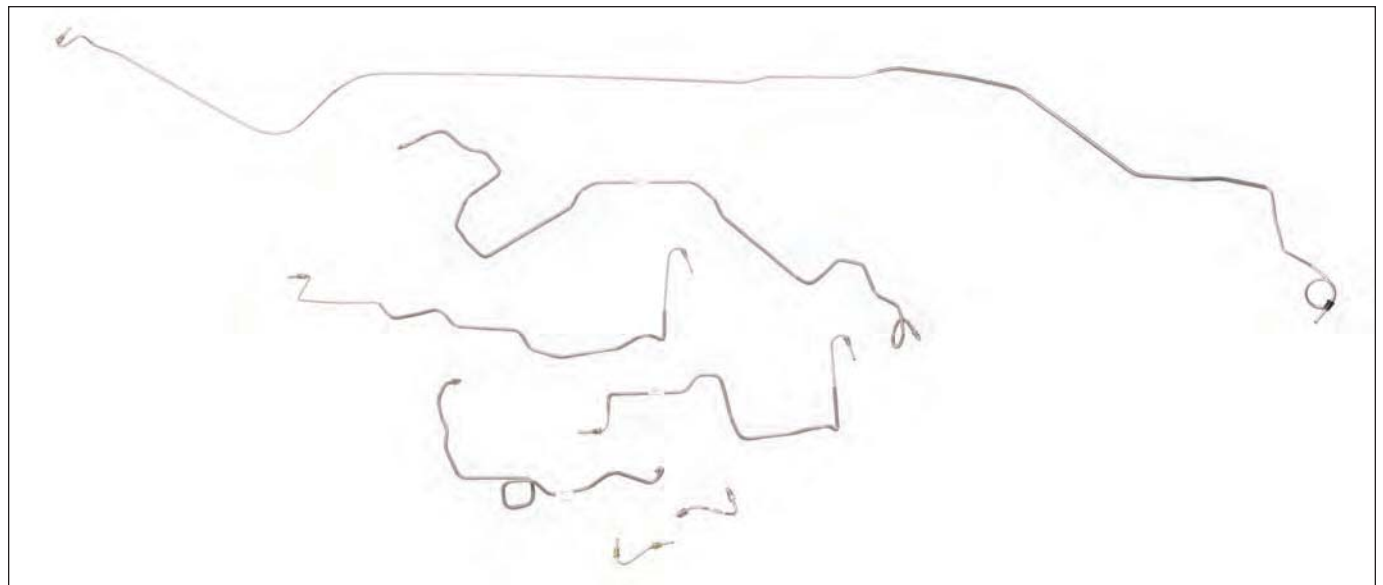

# PONTIAC

GP1021	1966	Standard Brake
GP1023	1966	Power Brake
GP1025	1967	Hardtop - Standard Drum
GP1027	1967	Hardtop - Power Drum
GP1029	1967	Hardtop - Power Disc
GP1031	1968	Standard Drum
GP1032	1968	Power Drum
GP1033	1968	Power Disc
GP1034	1969-70	Standard Drum
GP1035	1969-70	Power Drum
GP1036	1969-70	Power Disc
GP1043	1970	
GP1041	1971-72	Power Disc
CE1054	1978-81	Power Disc
GP1042	1978-87	Power Disc
BU1029	1982-87	Power Disc
CU1046	1988-93	Non - ABS
BU1047	1992-94	With ABS
PO1029	1997-99	Individual Front to Rear lines for Right Rear & Left Front

Caliper Inlet Lines & Transfer Tubes (Sold in Pairs)			O.E. Steel	Stainless Steel
Part No.	Year	Description		
GPD1001	1967	Front Inlet Lines - 4 Piston Caliper		

Fuel - Pump To Carburetor Line			O.E. Steel	Stainless Steel
Part No.	Year	Description		
GPC1001	1967	400 CID AFB Carburetor ( 3 Pc. )		
POC1009	1969	428 CID - 4 Barrel		
GLC1015	1972	400 455 CID - 4 Barrel - Quadrajel		

Fuel - Tank To Pump Line			O.E. Steel	Stainless Steel
Part No.	Year	Description		
GPF1002	1965	Convertible - 5/16"		
GPF1001	1966	Hardtop and Convertible - 3/8"		
GPF1006	1967	Hardtop 400 CID		
GPF1003	1969			
GPF1004	1970-72			
GPF1007	1973			
POF1027	1997-99	V6 F.I. Feed Line		
CUF1011	1988-91	3.1 Liter - 3/8"		
BUF1037	2000-05	3.8 Liter V6		

Fuel - Return Line			O.E. Steel	Stainless Steel
Part No.	Year	Description		
GPR1001	1966-68	Hardtop and Convertible		
GPR1002	1967	Convertible		
GPR1006	1967	Hardtop 400 CID		
GPR1003	1969			
GPR1004	1970-72	Hardtop and Convertible		
CUR1010	1988-91	3.1 Liter		
POR1008	1997-99	V6		
BUR1019	2000-05	3.8 Liter V6		

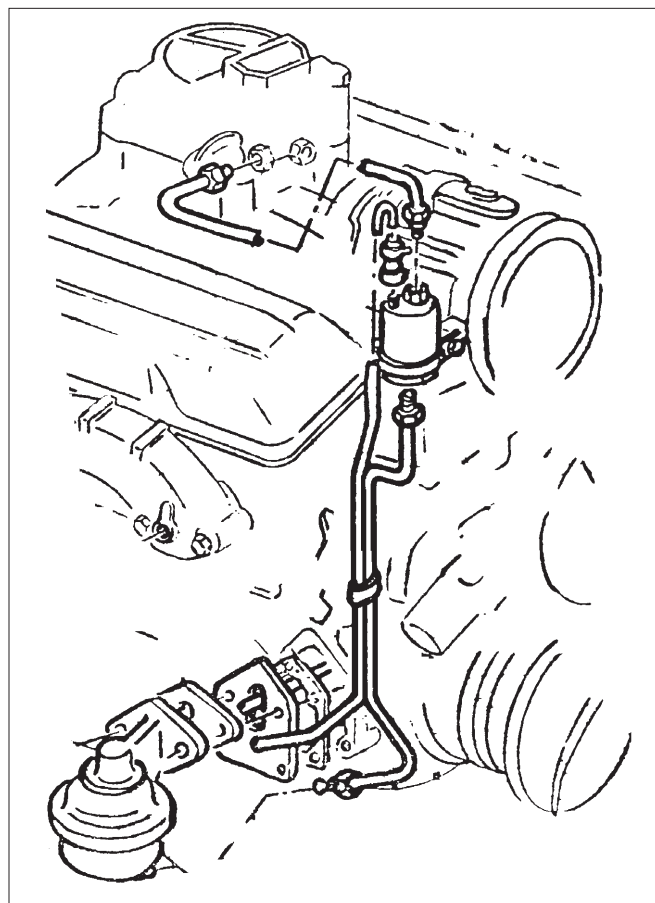
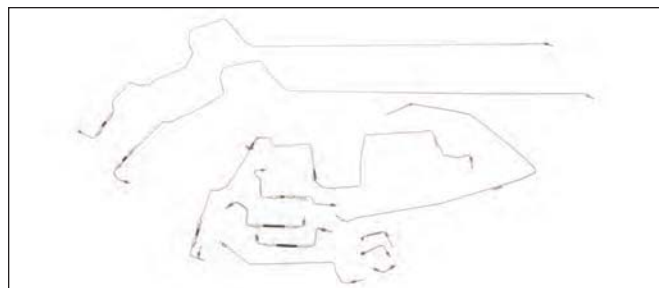

Fuel - Vapor Line			O.E. Steel	Stainless Steel
Part No.	Year	Description		
GPV1001	1971-72	5/16"		
BUV1005	1978-88	With A/C Only		
BUV1007	2000-05	3.8 Liter V6		

Fuel - Stand Pipe Set			O.E. Steel	Stainless Steel
Part No.	Year	Description		
BUS1002	1988-91	(3 Pc.) Fuel Injected		

Transmission Lines (Sold In Pairs)			O.E. Steel	Stainless Steel
Part No.	Year	Description		
GPT1001	1965	Powerglide - Hydramatic		
GPT1004	1969	T-400		
GPT1003	1970-72	T-400 - With 8" Between Radiator Ports		
GPT1005	1970-72	T-400 With 12" Between Radiator Ports		
GPT1006	1990-94	3.1 V6 4T60E Transmission		

Miscellaneous & Other Lines			O.E. Steel	Stainless Steel
Part No.	Year	Description		
GPM1002	1969	Modulator Vacuum Line		
GPO1001	1969	Power Steering Cooler Line		
GPM1001	1970-72	T-400 Modulator Vacuum Line		
POA1019	1976	400 CID - 4 Barrel Carburetor - With Air Conditioning - Brake Booster Vacuum Line		

# PONTIAC

## LeMANS / GTO

### Complete Brake Line Kit

Part No.	Year	Description	LeMans / GTO	
			O.E. Steel	Stainless Steel
SG1002	1964-65	LeMans Only - Hardtop - Standard Drum - 6 Cylinder		
SG1003	1964-65	LeMans Only - Hardtop - Power Drum - 6 Cylinder		
SG1004	1964-65	LeMans Only - Convertible - Standard Drum - 6 Cylinder		
SG1005	1964-65	LeMans Only - Convertible - Power Drum - 6 Cylinder		
GL1009	1964-65	Hardtop - Standard Drum - V8		
GL1010	1964-65	Hardtop - Power Drum - V8		
GL1011	1964-65	Convertible - Standard Drum - V8		
GL1012	1964-65	Convertible - Power Drum - V8		
GL1013	1966	Hardtop - Standard Drum - V8		
GL1014	1966	Hardtop - Power Drum - V8		
GL1015	1966	Convertible - Standard Drum - V8		
GL1016	1966	Convertible - Power Drum - V8		
SG1010	1966	LeMans Only - Hardtop - Standard Drum - 6 Cylinder		
SG1011	1966	LeMans Only - Hardtop - Power Drum - 6 Cylinder		
SG1013	1966	LeMans Only - Convertible - Standard Drum - 6 Cylinder		
SG1037	1966	LeMans Only - Convertible - Power Drum - 6 Cylinder		
CU1014	1967	LeMans Convertible - Power Drum - 6 Cylinder		
GL1045	1967	LeMans Convertible - Power Disc - 6 Cylinder		
GL1047	1967	Standard Drum - Hardtop - V8		
GL1048	1967	Power Drum - Hardtop - V8		
GL1049	1967	Power Disc - Hardtop - V8		
GL1050	1967	Standard Drum - Convertible - V8		
GL1051	1967	Power Drum - Convertible - V8		
GL1052	1967	Power Disc - Convertible - V8		
CU1033	1968-69	Hardtop - Standard Disc		
SG1022	1968-69	Hardtop - Standard Drum		
SG1023	1968-69	Hardtop - Power Drum		
SG1024	1968-69	Hardtop - Power Disc		
SG1025	1968-69	Convertible - Standard Drum		
SG1026	1968-69	Convertible - Power Drum		
SG1027	1968-69	Convertible - Power Disc		
CU1023	1970	Hardtop - Standard Disc		
CU1024	1970	Convertible - Standard Disc		
SG1028	1970	Hardtop - Power Disc		
SG1029	1970	Convertible - Power Disc		
CU1028	1971	Convertible - Standard Drum		
CU1029	1971	Convertible - Power Drum		
SG1035	1971	GTO Only - Convertible - Power Disc		
CU1025	1971-72	Hardtop - Standard Drum		
CU1026	1971-72	Hardtop - Power Drum		

SG1032	1971-72	Hardtop - Power Disc
SG1035	1971-72	LeMans Only - Convertible - Power Disc
GL1039	1973	Power Disc - Hardtop
NV1024	1974	GTO Only - Power Disc

### Caliper Inlet Lines & Transfer Tubes (Sold in Pairs)

Part No.	Year	Description	LeMans / GTO	
			O.E. Steel	Stainless Steel
CUD1001	1967	Disc (Inlet 3/8" and 3/8")		
GLD1001	1967	Disc (Inlet 7/16" and 1/2")		
GLD1003	1968	Disc Caliper Inlet: 7/16" and 1/2"		
GLD1005	1968-72	Drum Inlet Lines (2 Pc.)		

### Fuel - Pump To Carburetor Line

Part No.	Year	Description	LeMans / GTO	
			O.E. Steel	Stainless Steel
GLC1004	1964-65	Tri-Power (3 Pc.) Aluminum Only		
GLC1003	1966	4 Barrel (1 Pc.)		
GLC1005	1966	Tri-Power (3 Pc.) Aluminum Only		
FBC1002	1967	400 CID 335 HP Quadrajel Carburetor (1 Pc.)		
FBC1003	1967	400 CID - 4 Barrel - Inline Filter w/Return Line (3 Pc.)		
GLC1007	1967	400 CID - 2 Barrel		
FBC1004	1968	GTO 400 CID 4 Barrel Carburetor Non Ram Air IV		
GLC1017	1968-75	350 CID - 2 Barrel		
FBC1005	1969	400 CID 4 Barrel Carburetor		
GLC1012	1969	Ram Air - IV		
FBC1013	1970	400 CID 4 Barrel Carburetor		
GLC1014	1970	Ram Air - IV		
GLC1015	1971-74	455 CID - Quadrajel (1 Pc.)		

### Fuel - Tank To Pump Line

Part No.	Year	Description	LeMans / GTO	
			O.E. Steel	Stainless Steel
GLF1001	1964-66	Hardtop - 3/8" Left Side Routed		
GLF1002	1964-66	Convertible - 3/8"		
GLF1018	1964-66	LeMans Only - 5/16 - Hardtop - Right Side Routed - Inline 6		
GLF1019	1964-66	3/8" Hardtop Right Side Routed V8		
SGF1003	1964-66	LeMans Only - Convertible - 5/16"		
GLF1003	1967	Hardtop - 3/8"		
GLF1004	1967	Convertible - 3/8"		
SGF1004	1967	LeMans Only - Hardtop - 5/16"		
GLF1007	1968-69	Convertible - 3/8"		
SGF1008	1968-69	LeMans Only - Hardtop - 5/16" (1 Pc.)		
SGF1009	1968-69	LeMans Only - Convertible - 5/16" (1 Pc.)		
GLF1012	1970	455 CID H.O. Motor		
GLF1008	1970-72	Hardtop		
GLF1010	1973	Hardtop		
NVF1005	1974	GTO Only - 3/8" (2 Pc.)		

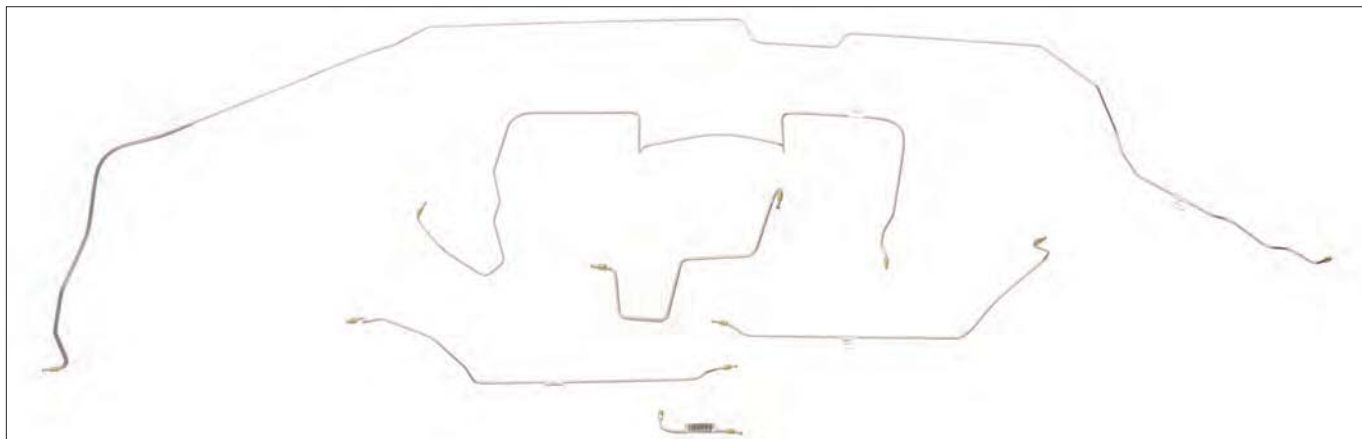

# PONTIAC

Fuel - Return Line			LeMans / GTO	
Part No.	Year	Description	O.E. Steel	Stainless Steel
GLR1002	1964-66	Convertible		
GLR1003	1967	Hardtop		
GLR1004	1967	Convertible		
GLR1005	1968-69	Hardtop		
GLR1006	1968-69	Convertible		
GLR1007	1970	Hardtop (2 Pc.)		
GLR1008	1970	Convertible - (2 Pc.)		
GLR1010	1971	Convertible - (2 Pc.)		
GLR1009	1971-72	Hardtop - (2 Pc.)		
GLR1011	1973			



Fuel - Vapor Line			LeMans / GTO	
Part No.	Year	Description	O.E. Steel	Stainless Steel
GLV1002	1971	Convertible (2 Pc.)		
GLV1001	1971-72	Hardtop (2 Pc.)		
GLV1004	1973	Chevrolet Motor - Right Side Route (2 Pc.)		
NWV1001	1974	GTO 1974		

Transmission Modulator Line			LeMans / GTO	
Part No.	Year	Description	O.E. Steel	Stainless Steel
GLM1001	1964-67	T-400 Only		
GLM1002	1967	T-400 - 400 CID - 4 Barrel		

Fuel - Vent Line			LeMans / GTO	
Part No.	Year	Description	O.E. Steel	Stainless Steel
GLV1006	1964-66	Gas Tank Filler Neck Vent Line		

Choke Tube			LeMans / GTO	
Part No.	Year	Description	O.E. Steel	Stainless Steel
GLK1002	1964	Tri-Power (2 Pc.)		
GLK1004	1965	Tri-Power (2 Pc.)		

Fuel - Stand Pipe Set			LeMans / GTO	
Part No.	Year	Description	O.E. Steel	Stainless Steel
BUS1005	1970	LeMans (3 Pc.)		

Hydraulic Clutch Line			LeMans / GTO	
Part No.	Year	Description	O.E. Steel	Stainless Steel
GLH1001	2004-06	GTO Only - Clutch Line Set (4 Pc.)		
GLH1003	2005-06	GTO - LS2 Engine - Hydraulic Clutch Bleed Hose		

Transmission Lines (Sold In Pairs)			LeMans / GTO	
Part No.	Year	Description	O.E. Steel	Stainless Steel
GLT1001	1964-67	Powerglide - 3/8"		
GLT1002	1967	T-400 - 5/16" Only		
GLT1003	1968-72	Powerglide		
GLT1004	1968-72	T-350 & T-400		
GLT1005	1973	T-350		
GLT1006	1974			

Miscellaneous & Other Lines			LeMans / GTO	
Part No.	Year	Description	O.E. Steel	Stainless Steel
GLO1005	1964-65	4 Barrel - Brake Booster Vacuum Line		
GLO1001	1964-66	Fuel - Filter to Return - A/C		
GLO1003	1964-66	Power Steering Line		
GLO1004	1964-66	Tri-Power - Brake Booster Vacuum		
GLA1001	1967	GTO Distributor Vacuum Advance Line w/ California Emissions		
GLA1001	1967	LeMans Distributor Vacuum Advance Line w/ California Emissions		
GLO1006	1967	400 CID - 4 Barrel - Brake Booster Vacuum Line		

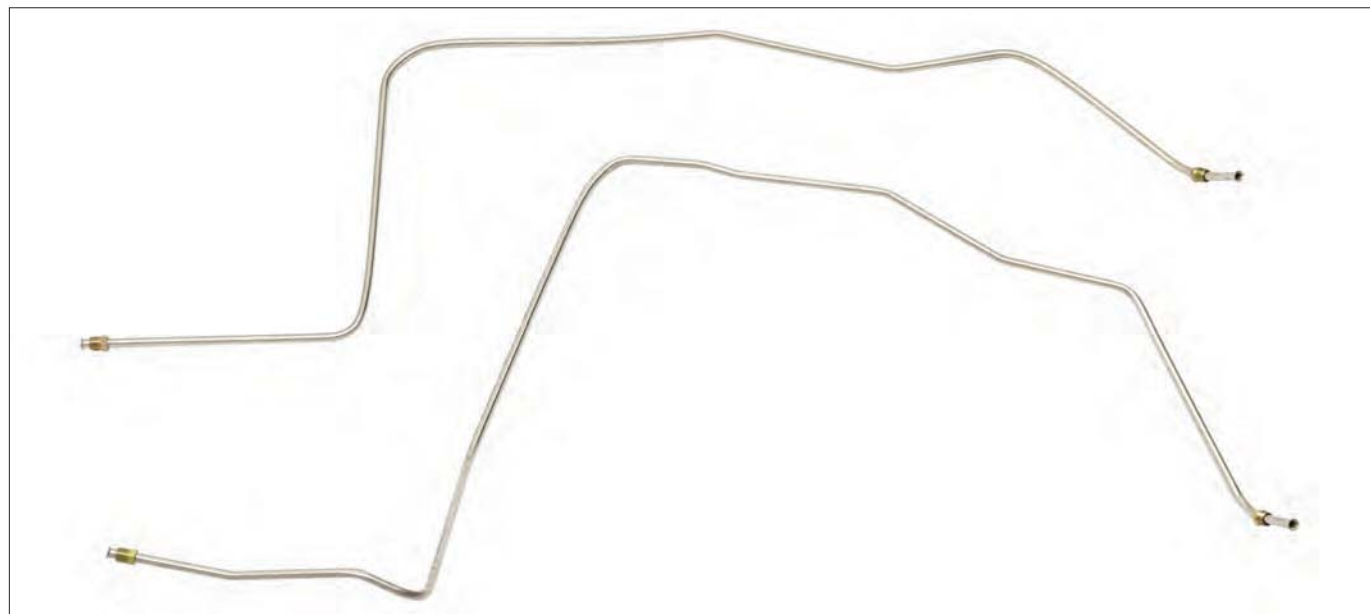

# MISC. DOMESTICS

## AMC

### Complete Brake Line Kit AMC

Part No.	Year	Description	O.E. Steel	Stainless Steel
AM1006	1964	Rambler		
AM1009	1967-69	Rambler American V8 - Power Disc		
AM1002	1968-69	AMX Power Disc Brakes - Without Sway Bar (8 Pc.)		
AM1003	1969	AMX Power Disc Brakes - With Sway Bar		
AM1004	1970	AMX Power Disc Brakes - Without Sway Bar		
AM1010	1970	AMX Power Disc Brakes - With Sway Bar		
AM1007	1971	Javelin Can Am Fenders		
AM1011	1979	Pacer Standard Disc		

### Caliper Inlet Lines & Transfer Tubes (Sold in Pairs) AMC

Part No.	Year	Description	O.E. Steel	Stainless Steel
AMD1002	1967	Rambler American V8 Power Disc		

### Fuel - Pump to Carburetor Line AMC

Part No.	Year	Description	O.E. Steel	Stainless Steel
AMC1001	1970-71	Javelin AMX With 390 CID Motor		

### Fuel - Tank To Pump Line AMC

Part No.	Year	Description	O.E. Steel	Stainless Steel
AMF1003	1968	Javelin		
AMF1001	1968-69	AMX (1 Pc.)		
AMF1002	1970	AMX 390 CID 4 Barrel		
AMF1004	1979	Pacer		

### Fuel - Vapor Line AMC

Part No.	Year	Description	O.E. Steel	Stainless Steel
AMV1001	1970	Javelin		

### Transmission Lines (Sold In Pairs) AMC

Part No.	Year	Description	O.E. Steel	Stainless Steel
AMT1001	1968	AMX		
AMT1002	1971	Javelin		

### Transmission Modulator Line AMC

Part No.	Year	Description	O.E. Steel	Stainless Steel
AMM1001	1970	AMX		
AMM1002	1970	Javelin Can Am Fenders		

## DeLOREAN

### Complete Brake Line Kit DeLorean

Part No.	Year	Description	O.E. Steel	Stainless Steel
DL1001	1981-83	DMC 12		

### Caliper Inlet Lines & Transfer Tubes (Sold in Pairs) DeLorean

Part No.	Year	Description	O.E. Steel	Stainless Steel
DLD1001	1981-83	DMC Front Inlet Lines		

### Fuel - Tank To Pump Line DeLorean

Part No.	Year	Description	O.E. Steel	Stainless Steel
DLF1001	1981-83	DMC 12 Tank to Pump		

### Fuel - Return Line DeLorean

Part No.	Year	Description	O.E. Steel	Stainless Steel
DLR1001	1981-83	DMC 12 Fuel - Return Line		

### Miscellaneous & Other Lines DeLorean

Part No.	Year	Description	O.E. Steel	Stainless Steel
DLO1002	1981-83	DMC 12 Booster Vacuum Line		
DLO1001	1981-83	DMC 12 Heater Lines		
DLO1003	1981-83	DMC 12 Radiator Overflow Line		

## GEO

### Complete Brake Line Kit GEO

Part No.	Year	Description	O.E. Steel	Stainless Steel
CT1116	1994-95	Tracker with ABS		



## HUDSON

### Complete Brake Line Kit Hudson

Part No.	Year	Description	O.E. Steel	Stainless Steel
HU1001	1940	44 8 Cylinder - Sedan		

### Fuel - Tank To Pump Line Hudson

Part No.	Year	Description	O.E. Steel	Stainless Steel
HUF1001	1940	44 8 Cylinder - Sedan		

## INTERNATIONAL

### Complete Brake Line Kit International

Part No.	Year	Description	O.E. Steel	Stainless Steel
IN1002	1978	Scout II 4WD Standard Disc		
IN1003	1978	Scout Traveler / Terra 4WD Standard Disc		
IN1001	1996	3800 Series (Bus)		

### Caliper Inlet Lines & Transfer Tubes (Sold in Pairs) International

Part No.	Year	Description	O.E. Steel	Stainless Steel
IND1001	1971-73	Scout II Drum - Front Inlet Lines		

### Fuel - Miscellaneous International

Part No.	Year	Description	O.E. Steel	Stainless Steel
INF1001	1965	Fuel - Pump Line 7.3 Liter Engine - (3 pc.)		

### Transmission Lines (Sold In Pairs) International

Part No.	Year	Description	O.E. Steel	Stainless Steel
INT1001	1978	Scout II 4WD Standard Disc		

## KAISER

### Complete Brake Line Kit Kaiser

Part No.	Year	Description	O.E. Steel	Stainless Steel
KA1003	1949			
KA1001	1954	Darrin		
KA1002	1954			

### Fuel - Tank To Pump Line Kaiser

Part No.	Year	Description	O.E. Steel	Stainless Steel
KAF1001	1949			

### Miscellaneous & Other Lines Kaiser

Part No.	Year	Description	O.E. Steel	Stainless Steel
KA01001	1954	Darrin Oil Line Set		
KA01002	1954	Darrin Water Coolant Line		

## LaSALLE

### Complete Brake Line Kit LaSalle

Part No.	Year	Description	O.E. Steel	Stainless Steel
LA1003	1934-38	All Models		
LA1001	1939	All Models		
LA1002	1940	All Models		

### Fuel - Pump To Carburetor Line LaSalle

Part No.	Year	Description	O.E. Steel	Stainless Steel
LAC1001	1938	All Models Fuel - Pump To Carburetor		

# MISC. DOMESTICS

Fuel - Tank To Pump Line			LaSalle	
Part No.	Year	Description	O.E. Steel	Stainless Steel
LAF1002	1938	All Models		
LAF1001	1940	All Models Fuel - Tank Line		

Miscellaneous & Other Lines			LaSalle	
Part No.	Year	Description	O.E. Steel	Stainless Steel
LA01001	1938	All Models Vacuum Lines (3 Pc.)		

## NASH

Complete Brake Line Kit			Nash	
Part No.	Year	Description	O.E. Steel	Stainless Steel
NA1001	1941	Ambassador Model # 4160		

## PACKARD

Complete Brake Line Kit			Packard	
Part No.	Year	Description	O.E. Steel	Stainless Steel
PA1006	1938	8 139" Wheel Base without Axle Lns.		
PA1006	1938	Super 8 139" Wheel Base without Axle Lns.		
PA1001	1938-41	Clipper 127" Wheelbase		
PA1001	1938-41	Custom Super 8 127" Wheelbase		
PA1001	1938-41	Super 8 127" Wheelbase		
PA1015	1938-41	6 & 110 With 122" Wheelbase		
PA1001	1939-40	120 127" Wheelbase		
PA1009	1946-47	Deluxe Clipper 120" Wheelbase		
PA1009	1946-47	Standard Clipper 120" Wheelbase		
PA1009	1948-49	Super 8 120" Wheelbase		
PA1009	1948-50	Deluxe 8 120" Wheelbase		
PA1009	1948-50	Standard 8 120" Wheelbase		
PA1013	1951-52	200 250 122" Wheelbase		
PA1013	1951-52	250 122" Wheel Base		
PA1022	1951-52	Patrician 127" Wheelbase		
PA1022	1951-52	300 127" Wheelbase		
PA1023	1953	Caribbean 127" Wheelbase		
PA1023	1953	Cavalier 127" Wheelbase		
PA1023	1953	Patrician 127" Wheelbase		
PA1024	1954	Caribbean 127" Wheelbase		
PA1024	1954	Cavalier 127" Wheelbase		
PA1024	1954	Patrician 127" Wheelbase		

Fuel - Pump To Carburetor Line			Packard	
Part No.	Year	Description	O.E. Steel	Stainless Steel
PAC1001	1954	All Models		
PAC1002	1955-56	Caribbean Carburetor Line 2 Barrel & 4 Barrel (3 Pc.)		
PAC1003	1956	2 Barrel 352 CID		

Fuel - Tank To Pump Line			Packard	
Part No.	Year	Description	O.E. Steel	Stainless Steel
PAF1007	1938	Tank to Pump (2 Pc.)		
PAF1006	1940	1800 only 110" - Customer needs to supply fittings		
PAF1001	1951	All Models		
PAF1002	1953-54	All Models		
PAF1005	1955	Caribbean Convertible - Tank Line		

Transmission Lines (Sold In Pairs)			Packard	
Part No.	Year	Description	O.E. Steel	Stainless Steel
PAT1001	1951	All Models 3/8"		
PAT1004	1953	All Models 3/8"		
PAT1002	1954	All Models 3/8"		
PAT1003	1955-56	All Models 5/16"		

Choke Tube			Packard	
Part No.	Year	Description	O.E. Steel	Stainless Steel
PAO1004	1956	Caribbean 2 - 4 Barrel		
PAK1001	1956	2 Barrel 352 CID		

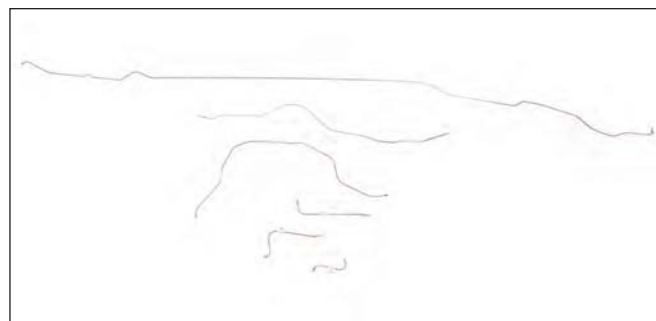

Miscellaneous & Other Lines			Packard	
Part No.	Year	Description	O.E. Steel	Stainless Steel
PA01017	1939	Super 8 Heater Line		
PA01002	1954	All Models Engine Vacuum Line Set		
PA01001	1954	All Models Hydraulic Convertible Top Lines		
PA01016	1955	All Models Hydraulic & Vacuum 352 CID (2 Pc.)		
PA01006	1955	All Models Power Steering Hoses - (2 Pc.)		
PA01003	1955-56	Caribbean 352 CID - V8 - Oil Filter Inlet and Outlet (2 Pc.)		
PA01019	1955-56	Caribbean Caribbean-Oil Vacuum Line		
PA01005	1955-56	Caribbean Vacuum To Wiper		
PA01018	1956	Caribbean Distributor Vacuum Line		

## STUDEBAKER

Complete Brake Line Kit			Studebaker	
Part No.	Year	Description	O.E. Steel	Stainless Steel
SA1004	1939	Commander		
SA1005	1950	Commander		
SA1006	1961	Hawk Manual Drum		
SA1001	1963	Avanti (7 Pc.)		

Caliper Inlet Lines & Transfer Tubes (Sold in Pairs)			Studebaker	
Part No.	Year	Description	O.E. Steel	Stainless Steel
SAD1002	1963-64	Avanti Caliper Inlet Lines - Pair		
SAD1001	1963-67	Avanti Dunlop Caliper Transfer Tubes - Pair		

Fuel - Pump To Carburetor Line			Studebaker	
Part No.	Year	Description	O.E. Steel	Stainless Steel
SAC1001	1950	Commander Carburetor to Pump Line		
PAC1003	1956	2 Barrel 352 CID		
SAC1002	1956	Golden Hawk 352 CID (Packard Engine) W/ (2) 4 Barrel Quadrajét Carburetor (3 pc.)		
SAC1003	1961	Lark 170 CID		

Fuel - Tank To Pump Line			Studebaker	
Part No.	Year	Description	O.E. Steel	Stainless Steel
SAF1001	1939	Commander 9A - 5/16" (2 Pc.)		
SAF1002	1950	Commander Fuel - Tank Line (3 Pc.)		
SAF1004	1956	Golden Hawk		
SAF1003	1961	Hawk All Models		

Choke Tube			Studebaker	
Part No.	Year	Description	O.E. Steel	Stainless Steel
SAK1001	1950	Commander Choke Tube		
Pak1001	1956	2 Barrel 352 CID		

Miscellaneous & Other Lines			Studebaker	
Part No.	Year	Description	O.E. Steel	Stainless Steel
SAV1001	1950	Commander Distributor Vacuum Line		
SAO1001	1950	Commander Oil Line (2 Pc.)		
SAO1002	1950	Commander Wiper Vacuum Line		
SAO1004	1956	Golden Hawk 352 CID (Packard Engine) W/ (2) 4 Barrel Quadrajét Carburetor - Engine Oil Filter Feed Line		
SAO1003	1956	Golden Hawk 352 CID (Packard Engine) W/ (2) 4 Barrel Quadrajét Carburetor - Engine Oil Filter Return Line		
SAA1001	1961	Lark 170 CID - Distributor Vacuum Line		

# IMPORTS

## AC CARS

Complete Brake Line Kit			AC Cars	
Part No.	Year	Description	O.E. Steel	Stainless Steel
AC1001	1954	Ace		

Hydraulic Clutch Line			AC Cars	
Part No.	Year	Description	O.E. Steel	Stainless Steel
ACH1001	1954	Ace		

## ALFA ROMEO

Complete Brake Line Kit			Alfa Romeo	
Part No.	Year	Description	O.E. Steel	Stainless Steel
AR1001	1960	All Models		
AR1002	1963	1600 Spyder		

Caliper Inlet Lines & Transfer Tubes (Sold in Pairs)			Alfa Romeo	
Part No.	Year	Description	O.E. Steel	Stainless Steel
ARD1001	1965	1600 Spyder Transfer Tubes		

Fuel - Tank To Pump Line			Alfa Romeo	
Part No.	Year	Description	O.E. Steel	Stainless Steel
ARF1001	1960	All Models Fuel - Tank Line		
ARF1003	1963	1600 Spyder Fuel - Tank Line (2 Pc.)		

## ALLARD

Complete Brake Line Kit			Allard	
Part No.	Year	Description	O.E. Steel	Stainless Steel
AL1001	1952	K-2		

## ASTON MARTIN

Complete Brake Line Kit			Aston Martin	
Part No.	Year	Description	O.E. Steel	Stainless Steel
AS1003	1965-71	DB6 Left Hand Drive		
AS1001	1967-72	DBS		

Hydraulic Clutch Line			Aston Martin	
Part No.	Year	Description	O.E. Steel	Stainless Steel
ASH1001	1968	DB5		

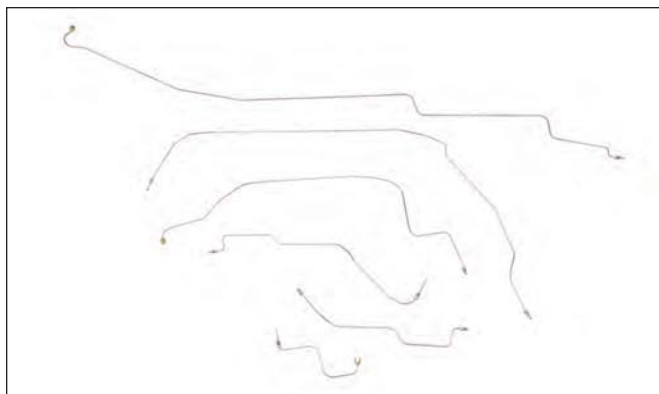

## AUSTIN HEALEY

Complete Brake Line Kit			Austin Healey	
Part No.	Year	Description	O.E. Steel	Stainless Steel
AH1008	1953-55	100-4 BN1		
AH1008	1955-56	100-4 BN2		
AH1003	1956-59	100-6 BN4 Left Hand Drive Non-Servo		
AH1003	1958-59	100-6 BN6 Left Hand Drive Non-Servo		
AH1002	1958-63	Sprite Left Hand Drive (6 Pc.)		
AH1001	1958-63	Sprite Right Hand Drive		
AH1003	1959-61	3000 BN7 Mk I Left Hand Drive Non-Servo		
AH1003	1959-61	3000 BT7 Mk I Left Hand Drive Non-Servo		
AH1004	1959-61	3000 BN7 Mk I Left Hand Drive With Servo		
AH1004	1959-61	3000 BT7 Mk I Left Hand Drive With Servo		
AH1006	1960-68	Princess - Limousine Right Hand Drive		
AH1003	1961-62	3000 BN7 Mk II Left Hand Drive Non-Servo		
AH1003	1961-62	3000 BT7 Mk II Left Hand Drive Non-Servo		
AH1004	1961-62	3000 BN7 Mk II Left Hand Drive With Servo		
AH1004	1961-62	3000 BT7 Mk II Left Hand Drive With Servo		
AH1003	1962-63	3000 BJ7 Left Hand Drive Non-Servo		
AH1004	1962-63	3000 BJ7 Left Hand Drive With Servo		
AH1004	1963-68	3000 BJ8 Left Hand Drive With Servo		
AH1007	1964-69	Sprite Left Hand Drive (6 Pc.)		

Caliper Inlet Lines & Transfer Tubes (Sold in Pairs)			Austin Healey	
Part No.	Year	Description	O.E. Steel	Stainless Steel
AHD1002	1953-55	100-4 BN1 Front Bridge Pipe - Drum (2 Pc.)		
AHD1002	1955-56	100-4 BN6 Front Bridge Pipe - Drum (2 Pc.)		
AHD1002	1956-59	100-6 BN4 Front Bridge Pipe - Drum (2 Pc.)		
AHD1004	1956-59	100-6 BN4 Front Bridge Pipe (2 Pc.)		
AHD1004	1958-59	100-6 BN6 Front Bridge Pipe (2 Pc.) with Non wire wheels		
AHD1003	1958-60	Midget Front Drum - Front Bridgepipe Set (2 Pc.)		
AHD1003	1958-60	Sprite Front Transfer Tubes		
AHD1001	1959-61	3000 BN7 MK I Front Inlet Lines - Disc		
AHD1001	1959-61	3000 BT7 MK I Front Inlet Lines - Disc		
AHD1001	1961-62	3000 BN7 MK II Front Inlet Lines - Disc		
AHD1001	1961-62	3000 BT7 MK II Front Inlet Lines - Disc		
AHD1001	1962-63	3000 BJ7 Front Inlet Lines - Disc		
AHD1001	1963-67	3000 BJ8 Front Inlet Lines - Disc		

Fuel - Tank To Pump Line			Austin Healey	
Part No.	Year	Description	O.E. Steel	Stainless Steel
AHF1004	1954	100-4 Fuel - Tank Line (2 Pc.) - Customer supplies male fitting		
AHF1005	1960	MK I 2 Pc.		
AHF1003	1958-61	Sprite (2 Pc.)		
AHF1001	1965-67	3000 Customer must supply fittings (2 Pc.)		

Hydraulic Clutch Line			Austin Healey	
Part No.	Year	Description	O.E. Steel	Stainless Steel
AHH1001	1958-60	Sprite		
AHH1001	1958-60	Midget Clutch Line		
AHH1002	1959-61	3000 BN7 MK I Left Hand Drive (2 Pc.)		
AHH1002	1959-61	3000 BT7 MK I Left Hand Drive (2 Pc.)		
AHH1002	1961-62	3000 BN7 MK II Left Hand Drive (2 Pc.)		
AHH1002	1961-62	3000 BT7 MK II Left Hand Drive (2 Pc.)		
AHH1002	1962-63	3000 BJ7 Left Hand Drive (2 Pc.)		
AHH1002	1963-68	3000 BJ8 Left Hand Drive (2 Pc.)		
AHH1005	1964-66	Sprite		

Miscellaneous & Other Lines			Austin Healey	
Part No.	Year	Description	O.E. Steel	Stainless Steel
AHO1002	1965-67	3000 Oil Line - Customer to supply fittings		

# IMPORTS

### BMW

#### Complete Brake Line Kit

Part No.	Year	Description	O.E. Steel	Stainless Steel
BM1001	1968-77	Model 2002 (9 Pc.)		
BM1004	1972-74	2002 tii (9 Pc.)		
BM1003	1985	325		

#### Caliper Inlet Lines & Transfer Tubes (Sold in Pairs)

Part No.	Year	Description	O.E. Steel	Stainless Steel
BMD1001	1969-76	Model 2002 Inlet Lines (4 Pc.)		
BMD1002	1972-74	2002 tii (4 Pc.)		

#### Fuel - Pump To Carburetor Line

Part No.	Year	Description	O.E. Steel	Stainless Steel
BMC1001	1968-71	2002 Carburetor Line		

#### Fuel - Tank To Pump Line

Part No.	Year	Description	O.E. Steel	Stainless Steel
BMF1003	1976	2002		
BMF1002	1985	325 Fuel - Set - (3 Pc.)		

#### Hydraulic Clutch Line

Part No.	Year	Description	O.E. Steel	Stainless Steel
BMH1001	1968-71	Model 2002		

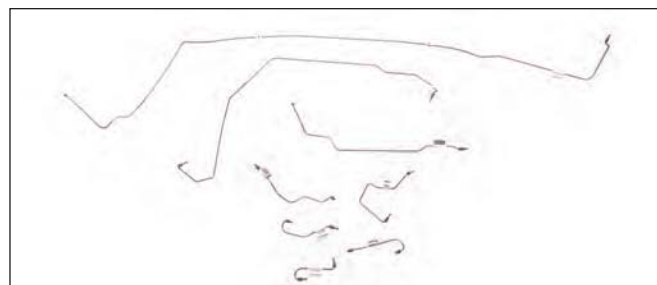

### DATSUN

#### Complete Brake Line Kit

Part No.	Year	Description	O.E. Steel	Stainless Steel
DA1001	1966	1600		
DA1008	1969-72	240Z (Oct 1969 - June 1972)		
DA1009	1973	240Z (July 1972 - July 1973)		
DA1006	1975-78	280Z		

#### Caliper Inlet Lines & Transfer Tubes (Sold in Pairs)

Part No.	Year	Description	O.E. Steel	Stainless Steel
DAD1006	1965-67	1600 Roadster Caliper Transfer Tubes		
DAD1001	1965-70	Roadster 1600 Inlet Lines		
DAD1001	1967-70	2000 Roadster Inlet Lines		
DAD1002	1970-72	240Z June 1972 - Rear Inlet Lines		
DAD1004	1970-73	240Z April 1973 - Front Inlet Lines		
DAD1003	1973	240Z April 1973 - Rear Inlet Lines		
DAD1005	1975-78	280Z Front Inlet Lines		
DAD1003	1977	280Z Rear Inlet Lines		

#### Fuel - Tank To Pump Line

Part No.	Year	Description	O.E. Steel	Stainless Steel
DAF1004	1966	1600 Roadster		
DAF1001	1968-69	1600 Roadster		
DAF1006	1973	240Z Apr-73		
DAF1003	1977	280Z Fuel - Injected		
DAF1007	1968-73	510 Tank Line		
DAF1005	1969-72	240Z Early 1972		
DAF1002	1974-75	240Z Late 1974		

#### Fuel - Return Line

Part No.	Year	Description	O.E. Steel	Stainless Steel
DAR1001	1968-69	1600 Roadster		
DAR1001	1968-69	Roadster 2000 Return Line (2 Pc.)		
DAR1006	1968-73	510		
DAR1004	1969-72	240Z Early 1972		
DAR1005	1973	240Z Apr-73		
DAR1002	1974-75	240Z Late 1974		
DAR1003	1977	280Z Fuel Injected		

#### Fuel - Vapor Line

Part No.	Year	Description	O.E. Steel	Stainless Steel
DAV1005	1968-73	510		
DAV1003	1972	240Z 4 Speed 6 Cylinder		
DAV1004	1973	240Z Apr-73		
DAV1001	1974-75	240Z Late 1974		
DAV1002	1977	280Z Fuel Injected		

#### Hydraulic Clutch Line

Part No.	Year	Description	O.E. Steel	Stainless Steel
DAH1006	1965-67	1600 Roadster Clutch Line		
DAH1002	1968-70	1600 Roadster Clutch Line		
DAH1002	1969	Roadster 2000		
DAH1001	1969-72	240Z Jun-72		
DAH1004	1972	240Z July-72		
DAH1003	1975-78	260Z Clutch Line		
DAH1003	1977	280Z		

#### Miscellaneous & Other Lines

Part No.	Year	Description	O.E. Steel	Stainless Steel
DAO1002	1969	Roadster 2000 Oil Pressure Line - (2 Pc.)		
DAO1002	1969	Roadster 1600 Oil Pressure Line - (2 Pc.)		

### DeTOMASO

#### Complete Brake Line Kit

Part No.	Year	Description	O.E. Steel	Stainless Steel
PN1001	1971	Pantera Early 1971		
PN1002	1972-87	Pantera Late 1971		

#### Fuel - Pump To Carburetor Line

Part No.	Year	Description	O.E. Steel	Stainless Steel
PNC1001	1971-87	Pantera 351C - 4 Barrel - Carburetor Line		

#### Hydraulic Clutch Line

Part No.	Year	Description	O.E. Steel	Stainless Steel
PNH1001	1971-87	Pantera Clutch Line - 1/4"		
PNH1003	1971-87	Pantera Clutch Line to Replace Plastic Hose to Slave Cylinder		
PNH1002	1971-87	Pantera Radiator Overflow Tube - 1/4"		
PNH1004	1971-87	Pantera Transmission Vent Tube - 3/16 w/Bracket		

### FERRARI

#### Caliper Inlet Lines & Transfer Tubes (Sold in Pairs)

Part No.	Year	Description	O.E. Steel	Stainless Steel
FED1004	1968-73	365 GT 2+2 Transfer Tubes		
FED1005	1968-73	365 GTB4 Rear Inlet Lines		
FED1002	1968-76	246 Dino Caliper Inlet Lines		
FED1003	1968-76	246 Dino Caliper Transfer Tubes		
ACD1002	1969-72	365GT Rear Girling Caliper Transfer Tube		

#### Fuel - Tank To Pump Line

Part No.	Year	Description	O.E. Steel	Stainless Steel
FEF1001	1969	365 GT 2+2 (2 Pc.)		

# IMPORTS

## FIAT

Fuel - Tank To Pump Line			Fiat	
Part No.	Year	Description	O.E. Steel	Stainless Steel
FIF1001	1974-88	X-19 Tank Line - 1/4"		

## GRIFFITH

Complete Brake Line Kit			Griffith	
Part No.	Year	Description	O.E. Steel	Stainless Steel
GR1001	1965-66	Series 200		

Transmission Lines (Sold In Pairs)			Griffith	
Part No.	Year	Description	O.E. Steel	Stainless Steel
GRT1001	1983	5.0L C4		

## HILLMAN

Complete Brake Line Kit			Hillman	
Part No.	Year	Description	O.E. Steel	Stainless Steel
HM1001	1962	All Models Convertible		

## HONDA

Fuel - Return Line			Honda	
Part No.	Year	Description	O.E. Steel	Stainless Steel
HOR1001	2000	Civic 1.6 Liter 4 Cylinder - 4 Door		

Fuel - Vapor Line			Honda	
Part No.	Year	Description	O.E. Steel	Stainless Steel
HOV1001	2000	Civic (2000) - 1.6 Liter 4 Cylinder - 4 Door		

## HUMMER

Complete Brake Line Kit			Hummer	
Part No.	Year	Description	O.E. Steel	Stainless Steel
HR1001	2003-07	H2 Brake Line Kit		

Fuel - Feed Line			Hummer	
Part No.	Year	Description	O.E. Steel	Stainless Steel
HRF1002	2003	H2		

Fuel - Return Line			Hummer	
Part No.	Year	Description	O.E. Steel	Stainless Steel
HRR1001	2003-07	H2		

Fuel - Vapor Line			Hummer	
Part No.	Year	Description	O.E. Steel	Stainless Steel
HRV1002	2003	H2		
HRV1001	2004-07	H2		

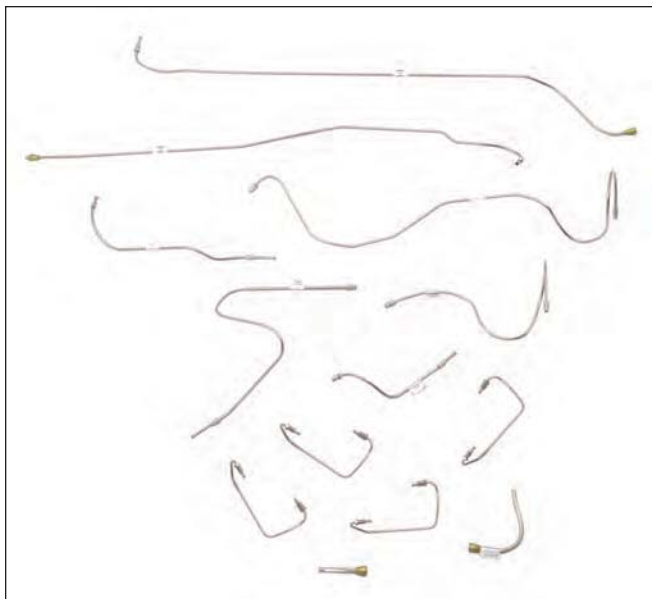

## JAGUAR

Complete Brake Line Kit			Jaguar	
Part No.	Year	Description	O.E. Steel	Stainless Steel
JG1001	1949-52	XK120 (Early 1952) - Single M/C Right Hand Drive (10 Pc.) - Left Front Missing		
JG1002	1951-53	C-Type Race Car		
JG1012	1951-57	Mark VII (9 Pc.)		
JG1016	1952-54	XK120 (Late 1952) Dual M/C Left Hand Drive (13 Pc.)		
JG1004	1954-58	XK140 Standard Transmission		
JG1018	1958-61	XK150 Automatic Transmission (9 Pc.)		
JG1005	1958-61	XK150 Standard Transmission (8 Pc.)		
JG1003	1959-61	MK 9 (10 Pc.)		
JG1011	1959-67	MK II Right Hand Drive		
JG1023	1959-67	MK II Left Hand Drive - Manual Transmission		
JG1006	1961-64	XKE Series 1 (Early)		
JG1007	1965-68	XKE Series 1		
JG1009	1966-68	2 + 2 Light switch on Fire wall		
JG1022	1968	4.2 Series 1.5		
JG1008	1968-71	XKE Series 2- (Early 1968 to Late 1971)		
JG1010	1971	XKE Series 3 V-12 (9 Pc.)		
JG1013	1972-74	XKE Series 3 V-12 (9 Pc.)		
JG1019	1973-79	XJ6-C All Models		
JG1019	1973-79	XJ12 (12 Pc.)		

Caliper Inlet Lines & Transfer Tubes (Sold in Pairs)			Jaguar	
Part No.	Year	Description	O.E. Steel	Stainless Steel
JGD1010	1949-58	XK140 Wheel Cylinder Transfer Tube		
JGD1021	1951-57	MK 7 Front Inlet Lines		
JGD1020	1959-60	XK150 Front Inlet lines (2 Pc.)		
JGD1023	1959-61	MK 9 Front Inlet Lines		
JGD1001	1959-67	All Models Dunlop - Front Caliper Transfer Tube		
JGD1004	1959-67	All Models Dunlop - Rear Caliper Transfer Tube		
JGD1024	1959-67	MK 2 Front Inlet Lines		

# IMPORTS

JGD1014	1961-64	XKE Front Inlet Lines Series 1
JGD1011	1963-68	3.8 "S" Dunlop - Front Caliper Inlet Lines
JGD1013	1965-68	XKE Front Inlet Lines
JGD1022	1968-71	XKE 4.2 Series 2 - Front Inlet Lines
JGD1009	1968-74	XKE Girling - Rear Caliper Transfer Tube
JGD1009	1969-87	XJ12 Girling - Rear Caliper Transfer Tube
JGD1012	1971-74	V12 Front Inlet Lines
JGD1003	1973-79	XJ6 Front Inlet Lines
JGD1003	1975	XJ6 Front Inlet Lines
JGD1009	1976-93	3.4 Liter & 3.8 Liter Girling - Rear Caliper Transfer Tube
JGD1009	1976-93	XJ-S Girling - Rear Caliper Transfer Tube

Fuel - Tank To Pump Line			Jaguar	
Part No.	Year	Description	O.E. Steel	Stainless Steel
JGF1010	1949-58	XK120 and XK140 (4 Pc.)		
JGF1001	1962	MK II Fuel - Line Short - 3/8"		
JGF1002	1964-67	XKE Fuel - Tank Line (2 Pc.)		
JGF1009	1971	XKE (2 Pc)		
JGF1006	1971-74	XKE V-12 3/8" No bulkhead fittings (3 Pc.)		

Fuel - Return Line			Jaguar	
Part No.	Year	Description	O.E. Steel	Stainless Steel
JGF1007	1971-74	XKE V 12 5/16" (3 Pc.)		

Fuel - Vent Line			Jaguar	
Part No.	Year	Description	O.E. Steel	Stainless Steel
JGV1001	1970	XKE (2 Pc.)		
JGF1008	1971-74	XKE V 12 3/16" (2 Pc.)		

Hydraulic Clutch Line			Jaguar	
Part No.	Year	Description	O.E. Steel	Stainless Steel
JGH1001	1958-61	XK150 Set (4 Pc.)		
JGH1002	1961-64	XKE Set (3 Pc.) - Right Hand Drive		
JGH1007	1961	XKE Set (4 Pc.) - Left Hand Drive		
JGH1003	1965	XKE Set (4 Pc.)		
JGH1004	1966-68	XKE Series 2 - Set (5 Pc.)		
JGH1006	1968-71	XKE Set (4 Pc.)		
JGH1008	1971-74	XKE Series 3 V12 - Left Hand Drive		

Miscellaneous & Other Lines			Jaguar	
Part No.	Year	Description	O.E. Steel	Stainless Steel
JG01002	1962	MK II Brake Booster Vacuum		
JG01001	1974	XKE Vacuum Tank to Firewall		

## JENSEN HEALEY

Complete Brake Line Kit			Jensen Healey	
Part No.	Year	Description	O.E. Steel	Stainless Steel
JH1001	1972-75	Left Hand Drive		

Caliper Inlet Lines & Transfer Tubes (Sold in Pairs)			Jensen Healey	
Part No.	Year	Description	O.E. Steel	Stainless Steel
JHD1001	1972-75	Front Inlet Lines		

## LAMBORGHINI

Miscellaneous & Other Lines			Lamborghini	
Part No.	Year	Description	O.E. Steel	Stainless Steel
LB01001	2002-05	Exhaust Sensors Lines		

## LAND ROVER

Complete Brake Line Kit			Land Rover	
Part No.	Year	Description	O.E. Steel	Stainless Steel
LR1002	1984-94	Truck - Defender 110 V8 Electronic Fuel Injection Only		
LR1003	1997	Truck - Defender 90 V8 Electronic Fuel Injection Only		

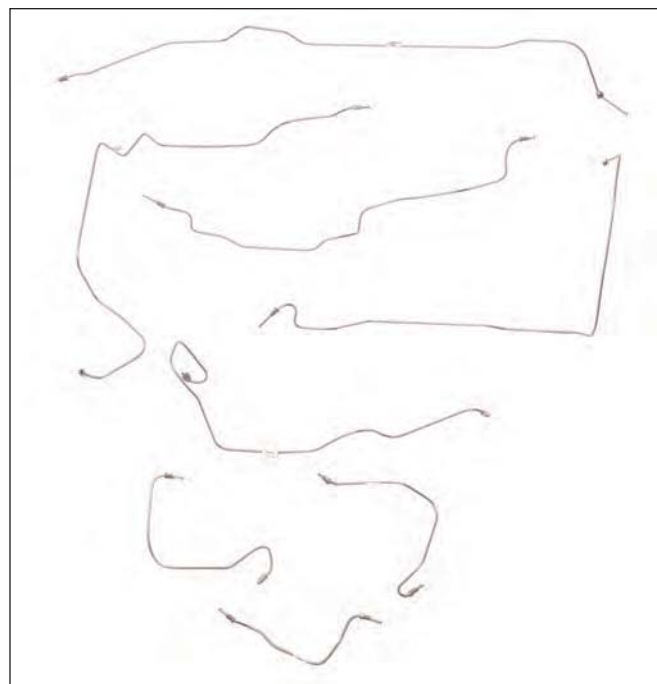

Fuel - Tank To Pump Line			Land Rover	
Part No.	Year	Description	O.E. Steel	Stainless Steel
LRF1002	1994-97	Truck - Defender 110 V8 Electronic Fuel Injection		
LRF1001	1994-97	Truck - Defender 90 V8 Electronic Fuel Injection Only - (2 Pc.)		

Fuel - Return Line			Land Rover	
Part No.	Year	Description	O.E. Steel	Stainless Steel
LRR1002	1997	Truck - Defender 110 V8 Electronic Fuel Injection (2 Pc.)		
LRR1003	1997	Truck - Defender 90 V8 Electronic Fuel Injection Only		

Hydraulic Clutch Line			Land Rover	
Part No.	Year	Description	O.E. Steel	Stainless Steel
LRH1002	1984-97	Truck - Defender 90 and Defender 110 V8 Diesel Only		
LRH1001	1984-97	Truck - Defender 90 & 110 V8 Electronic Fuel Injection Only - Gas Motor (2 Pc.)		

## LOTUS

Complete Brake Line Kit			Lotus	
Part No.	Year	Description	O.E. Steel	Stainless Steel
LO1001	1960	Elite		
LO1002	1969	Elan		
LO1003	1973	Elan		

## MERCEDES

Complete Brake Line Kit			Mercedes	
Part No.	Year	Description	O.E. Steel	Stainless Steel
MD1006	1954	300 SL Kit (6 Pc.)		
MD1001	1954	220		
MD1005	1956	300 C		
MD1002	1957	300 S/SC		
MD1003	1964	230 SL		
MD1004	1970	280 SL		
MD1007	1981	280 SE		

# IMPORTS

Fuel - Tank To Pump Line			Mercedes	
Part No.	Year	Description	O.E. Steel	Stainless Steel
MDF1003	1956	300 C Fuel - Tank Line		
MDF1001	1964	230 SL Fuel - Tank Line - 3/8"		

Fuel - Return Line			Mercedes	
Part No.	Year	Description	O.E. Steel	Stainless Steel
MDF1002	1964	230 SL Fuel - Return Line - 5/16"		

Fuel - Vent Line			Mercedes	
Part No.	Year	Description	O.E. Steel	Stainless Steel
MDF1005	1954	300 SL Tank Vent Line - 3/16"		

Miscellaneous & Other Lines			Mercedes	
Part No.	Year	Description	O.E. Steel	Stainless Steel
MDO1001	1954	300 SL Heater Pipes		
MDF1004	1956	300 C Oil Line		

## MG

Complete Brake Line Kit			MG	
Part No.	Year	Description	O.E. Steel	Stainless Steel
MG1013	1950-53	TF Right Hand Drive		
MG1018	1950-53	TF Left Hand Drive		
MG1018	1950-55	TD Left Hand Drive		
MG1013	1950-55	TD Right Hand Drive		

MG1001	1955-56	MGA Left Hand Drive		
MG1021	1957-59	MGA 1500 Left Hand Drive		
MG1006	1958-60	MGA Twin cam 4 Wheel Disc Twin Cam - 4 Wheel Disc Brakes		
AH1002	1958-63	Midget Left Hand Drive (6 Pc.)		
MG1006	1959-60	MGA 1600 Mk II Deluxe (4 Wheel Disc Brakes) - Left Hand Drive		
MG1020	1960	1600 (Non 4 Wheel Disc Brakes) Left Hand Drive		
MG1020	1960	MGA Mark II - Left Hand Drive		
AH1001	1961-63	Midget Right Hand Drive		
MG1016	1962	MGA 1600 MKII Roadster - (7 pc.)		
AH1007	1964-69	Midget Left hand drive		
MG1015	1967	MGB (6 Pc.)		
MG1002	1969	MGC Wire Wheel (13 Pc.) Customer to Supply (2) 7/16-20 Female Fittings		
MG1003	1973-74	MGB MK III		
MG1004	1974-76	MGB GT-V8 (5 Pc.)		
MG1007	1974-79	Midget		
MG1019	1975-76	MGB Power Disc (6 Pc.)		
MG1008	1977-80	MGB Power Disc (6 Pc.)		

Caliper Inlet Lines & Transfer Tubes (Sold in Pairs)			MG	
Part No.	Year	Description	O.E. Steel	Stainless Steel
MGD1003	1950-53	TD Front Transfer Tubes (2 Pc.)		
MGD1003	1953-55	TF Front Bridgepipe Set (2 Pc.)		
MGD1004	1955-59	MGA Front Drum - Front Bridgepipe Set (2 Pc.)		
MGD1002	1959	MGA Twin Cam 4 Wheel Disc Brakes - Inlet Lines		
MGD1001	1959	MGA Twin Cam 4 Wheel Disc Brakes - Transfer Tubes		
MGD1001	1959-60	MGA Twin Cam 4 Wheel Disc Brakes - Rear Transfer Tubes		



## IMPORTS

Fuel - Pump To Carburetor Line			MG	
Part No.	Year	Description	O.E. Steel	Stainless Steel
MGC1001	1955-62	MGA		
MGC1002	1969	MGC Carburetor Overflow (2 Pc.)		

Fuel - Tank To Pump Line			MG	
Part No.	Year	Description	O.E. Steel	Stainless Steel
MGF1006	1955-62	MGA (1 Pc.)		
MGF1007	1963-67	MGB (2 Pc.)		
MGF1001	1969	MGC Fuel - Tank Line (5 Pc.)		
MGF1003	1972-74	MGB (2 Pc.)		
MGF1004	1974-80	MGB Fuel - Tank Line - 5/16"		

Fuel - Return Line			MG	
Part No.	Year	Description	O.E. Steel	Stainless Steel
MGR1001	1969	MGB Fuel- Return Line - 5/16"		
MGR1005	1974-80	MGB Return 1/4"		

Hydraulic Clutch Line			MG	
Part No.	Year	Description	O.E. Steel	Stainless Steel
MGH1006	1955-62	MGA Non Twin Cam		
MGH1003	1958-60	MGA Twin Cam 4 Wheel Disc Brakes (2 Pc.)		
MGH1005	1962-67	MGB		
MGH1004	1967-69	MGC		
MGH1001	1972-74	MGB		
MGH1002	1975-80	MGB 1/4" (1 Pc.)		

Miscellaneous & Other Lines			MG	
Part No.	Year	Description	O.E. Steel	Stainless Steel
MGF1002	1969	MGC Carburetor Overflow Line Set (2 Pc.)		
MG01001	1971	MGB Heater Line - 1/2"		

### MINI

Fuel - Tank To Pump Line			Mini	
Part No.	Year	Description	O.E. Steel	Stainless Steel
MIF1001	1967	Cooper 1/4" Line		

Miscellaneous & Other Lines			Mini	
Part No.	Year	Description	O.E. Steel	Stainless Steel
MIO1001	1967	Cooper Suspension Line Set (2 Pc.) 3/8" Lines		

### MITSUBISHI

Complete Brake Line Kit			Mitsubishi	
Part No.	Year	Description	O.E. Steel	Stainless Steel
MB1001	1990-94	Eclipse GSX AWD - Non ABS		
MB1001	1990-94	Talon Tsi AWD - Non ABS		

Caliper Inlet Lines & Transfer Tubes (Sold in Pairs)			Mitsubishi	
Part No.	Year	Description	O.E. Steel	Stainless Steel
MBD1001	1990-94	Eclipse GSX AWD - Non ABS		
MBD1001	1990-94	Talon Tsi AWD - Non ABS		

Fuel - Tank To Pump Line			Mitsubishi	
Part No.	Year	Description	O.E. Steel	Stainless Steel
MBF1001	1990-94	Eclipse GSX Fuel Line		
MBF1001	1990-94	Talon Tsi Fuel Line		

Fuel - Return Line			Mitsubishi	
Part No.	Year	Description	O.E. Steel	Stainless Steel
MBR1001	1990-94	Eclipse GSX Fuel Return Line		
MBR1001	1990-94	Talon Tsi Fuel Return Line		

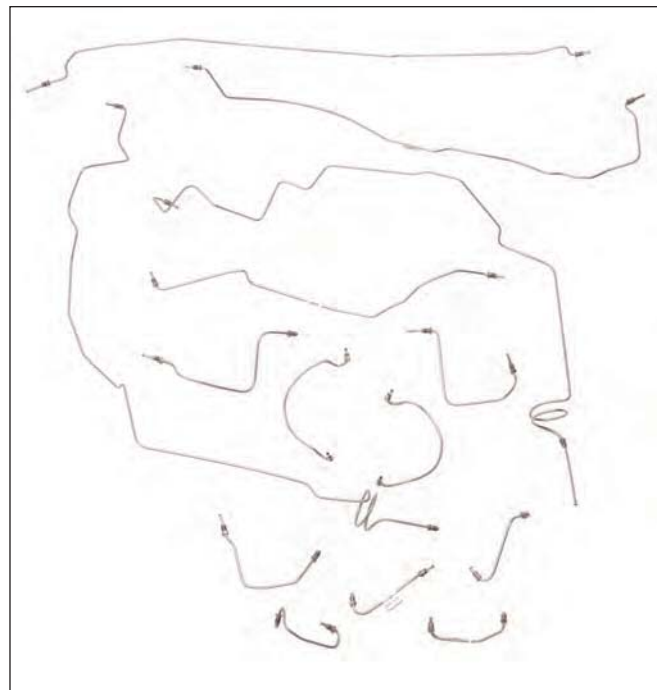

Fuel - Vapor Line			Mitsubishi	
Part No.	Year	Description	O.E. Steel	Stainless Steel
MBV1001	1990-94	Eclipse GSX Fuel Vapor Line		
MBV1001	1990-94	Talon Tsi Fuel Vapor Line		

Hydraulic Clutch Line			Mitsubishi	
Part No.	Year	Description	O.E. Steel	Stainless Steel
MBH1001	1990-94	Eclipse GSX AWD - Non ABS		
MBH1001	1990-94	Talon Tsi AWD - Non ABS		

### MORGAN

Complete Brake Line Kit			Morgan	
Part No.	Year	Description	O.E. Steel	Stainless Steel
MN1001	1950-58	Plus 4 Drum Brakes Left Hand Drive		
MN1002	1959	Plus 4 Drum Brakes Left Hand Drive		

### NISSAN

Fuel - Tank To Pump Line			Nissan	
Part No.	Year	Description	O.E. Steel	Stainless Steel
DAF1008	1990	1500 2WD Shortbed		

Fuel - Return Line			Nissan	
Part No.	Year	Description	O.E. Steel	Stainless Steel
DAR1007	1990	1500 2WD Shortbed		

Fuel - Vapor Line			Nissan	
Part No.	Year	Description	O.E. Steel	Stainless Steel
DAV1006	1990	1500 2WD Shortbed		

# IMPORTS

## PORSCHE

Complete Brake Line Kit			Porsche	
Part No.	Year	Description	O.E. Steel	Stainless Steel
PS1003	1972	Porsche 911		
PS1004	1974	Porsche 914		

Caliper Inlet Lines & Transfer Tubes (Sold in Pairs)			Porsche	
Part No.	Year	Description	O.E. Steel	Stainless Steel
PS1001	1967-69	911 Caliper Transfer Lines		
PS1002	1970-75	911 Caliper Transfer Lines		

## SUNBEAM

Complete Brake Line Kit			Sunbeam	
Part No.	Year	Description	O.E. Steel	Stainless Steel
SB1004	1960-63	Alpine Series II (7 Pc.)		
SB1006	1964	IMP Hatchback - 2 door		
SB1005	1964-65	Alpine Series 4 and 5 - Non Servo		
SB1002	1964-66	Tiger Non Power Brakes		
SB1001	1964-66	Tiger Power Brakes		
SB1008	1964-67	Alpine Series 4 and 5 - Automatic Transmission - With Servo		
SB1005	1965-68	Alpine Series 5 - Non Servo		
SB1007	1967	Tiger Non-Power (7 Pc.)		
SB1003	1967	Tiger Power Brakes (8 Pc.)		

Caliper Inlet Lines & Transfer Tubes (Sold in Pairs)			Sunbeam	
Part No.	Year	Description	O.E. Steel	Stainless Steel
SBD1002	1964	IMP Inlet Lines 2 Door Hatchback		
SBD1001	1964	IMP Transfer Tubes - 2 Door Hatchback		

Fuel - Tank To Pump Line			Sunbeam	
Part No.	Year	Description	O.E. Steel	Stainless Steel
SBF1001	1965	Tiger Fuel - Tank Line (4 Pc.)		

Hydraulic Clutch Line			Sunbeam	
Part No.	Year	Description	O.E. Steel	Stainless Steel
SBH1004	1960-63	Alpine Series II (7 Pc.)		
SBH1005	1964	IMP 2 Door Hatchback		

## TOYOTA

Complete Brake Line Kit			Toyota	
Part No.	Year	Description	O.E. Steel	Stainless Steel
TY1009	1963-67	Land Cruiser FJ-45 (1963-67)		
TY1003	1971-75	Land Cruiser FJ-40 9/71-9/75 (9 Pc.)		
TY1004	1975-80	Land Cruiser FJ-40 Late 1975		
TY1005	1984-85	4 Runner		
TY1008	1990	Truck 4 WD		
TY1007	1992-94	Camry 4 Door (6 Pc.)		

Caliper Inlet Lines & Transfer Tubes (Sold in Pairs)			Toyota	
Part No.	Year	Description	O.E. Steel	Stainless Steel
TYD1008	1963-67	Truck Land Cruiser FJ-40 Rear Bridgepipe Set		
TYD1007	1968-70	Truck Land Cruiser FJ-40 (1968 - 7/1970) Front Inlet Lines		
TYD1008	1968-70	Truck Land Cruiser FJ-40 (1968 - 7/1970) Rear Bridgepipe Set		
TYD1010	1970-71	Truck Land Cruiser FJ-40 (7/1970 - 9/1971) Front Inlet Line Set		
TYD1006	1970-71	Truck Land Cruiser FJ-40 (7/1970 - 9/1971) Rear Bridge Pipe Set		
TYD1009	1971-75	Truck Land Cruiser (9/71-75) Front Inlet Line Set		
TYD1001	1975-84	Land Cruiser Inlet Lines		
TYD1005	1988	Corolla Rear Inlet Lines (2 Pc.)		

Wheel Cylinder Lines (Sold in Pairs)			Toyota	
Part No.	Year	Description	O.E. Steel	Stainless Steel
TYD1002	1971-84	Land Cruiser Wheel Cylinder Lines		

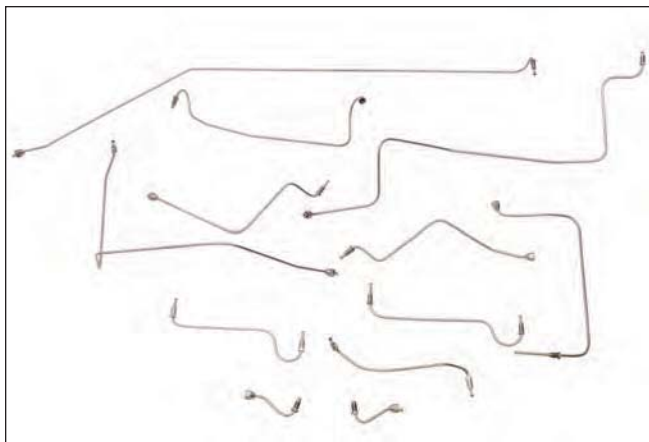

Fuel - Pump To Carburetor Line			Toyota	
Part No.	Year	Description	O.E. Steel	Stainless Steel
TYC1001	1965-70	Corona 3RB and 3RC Engines		

Fuel - Tank To Pump Line			Toyota	
Part No.	Year	Description	O.E. Steel	Stainless Steel
TYF1001	1975	Land Cruiser (4 Pc.)		
TYF1004	1976	FJ40		
TYF1002	1988	Corolla 4 Cylinder Carbureted Engine		
TYF1003	1992-94	Camry 4 Door		

Fuel - Return Line			Toyota	
Part No.	Year	Description	O.E. Steel	Stainless Steel
TYR1004	1972	Toyota Truck Land Cruiser (2 Pc.)		
TYR1003	1976	FJ40		
TYR1001	1988	Corolla 4 Cylinder Carbureted Engine		
TYR1002	1992-94	Camry 4 Door		

Fuel - Vapor Line			Toyota	
Part No.	Year	Description	O.E. Steel	Stainless Steel
TYV1001	1988	Corolla 4 Cylinder Carbureted Engine		
TYV1002	1992-94	Camry 4 Door		

Hydraulic Clutch Line			Toyota	
Part No.	Year	Description	O.E. Steel	Stainless Steel
TYH1001	1979-84	Land Cruiser		

## TRIUMPH

Complete Brake Line Kit			Triumph	
Part No.	Year	Description	O.E. Steel	Stainless Steel
TR1001	1945-48	TR1800 Right Hand Drive		
TR1002	1953-56	TR2 Right Hand Drive - Lockheed System		
TR1002	1953-56	TR3 Right Hand Drive - Lockheed System		
TR1016	1956-62	TR3 Right Hand Drive - Girling System		
TR1016	1962-64	TR4 Right Hand Drive - Girling System		
TR1012	1962-67	Spitfire Mark II Single Master Cylinder Line		
TR1004	1965-67	TR4A Independent Rear Suspension		
TR1017	1965-67	TR4A Rigid Rear Suspension		
TR1021	1966-67	GT6 Left Hand Drive Single Master Cylinder Line System		
TR1005	1967-68	TR250		
TR1022	1968	GT6 Left Hand Drive Dual Master Cylinder Line System		
TR1013	1969-72	GT6 10 Pc.		
TR1006	1969-76	TR6 Early - Before Chassis #CC81078		
TR1007	1969-76	TR6 Late		
TR1009	1971-73	Stag		
TR1023	1971-73	GT6 Left Hand Drive		

## IMPORTS

TR1015	1975-80	Spitfire 1500
TR1008	1975-80	TR7 State Chassis Number
TR1008	1975-80	TR8 State Chassis Number
TR1020	1978-81	TR8 Left Hand Drive

Caliper Inlet Lines & Transfer Tubes (Sold in Pairs)			Triumph	
Part No.	Year	Description	O.E. Steel	Stainless Steel
TRD1008	1953-56	TR2 Front Bridge Pipe - Drum (2 Pc.)		
TRD1008	1953-56	TR3 Front Bridge Pipe - Drum (2pc.)		
TRD1006	1962-67	GT6		
TRD1006	1962-67	Spitfire 4 Inlet Lines		
TRD1006	1962-67	Spitfire 4		
TRD1010	1965-67	TR4A Front Inlet Lines (2 Pc.)		
TRD1006	1966-68	GT-6 Inlet Lines		
TRD1001	1966-70	GT6 Inlet Lines (2 Pc.)		
TRD1010	1967-68	TR250 Front Inlet Lines (2 Pc.)		
TRD1006	1967-70	Spitfire MK III Inlet Lines		
TRD1006	1967-70	Spitfire Mark III		
TRD1007	1969-72	GT6 w/Roto Flex Suspension - Inlet Lines		
TRD1010	1969-72	TR6 Front Inlet Lines (2 Pc.)		
TRD1004	1969-76	TR6 Early Chassis - Front Inlet Lines		
TRD1005	1969-76	TR6 After Chassis - Front Inlet Lines		
TRD1006	1970-74	Spitfire MK IV Inlet Lines		
TRD1002	1971-72	GT6 Front Calipers		
TRD1003	1972	GT6 Rear Calipers		
TRD1006	1974-80	Spitfire 1500 Inlet Lines		
TRD1006	1975-80	Spitfire 1500		

Fuel - Pump To Carburetor Line			Triumph	
Part No.	Year	Description	O.E. Steel	Stainless Steel
TRC1003	1953-56	TR2 (2 Pc.)		
TRF1009	1953-62	TR3 Tank Line Left Side Outlet (late 1960) 5/16" (2 Pc.)		
TRF1009	1953-62	TR3A Tank Line Left Side Outlet (late 1960) 5/16" (2 Pc.)		
TRF1009	1955-61	TR3 TR3A Tank Line Left Side Outlet (late 1960) 5/16" (2 Pc.)		
TRC1002	1957-61	TR3B (2 Pc.)		
TRC1002	1957-61	TR4 (2 Pc.)		
TRC1002	1957-61	TR4A (2 Pc.)		
TRC1002	1961-67	TR4A (2 Pc.)		
TRC1002	1961-67	TR4 1/4"		
TRC1001	1967-68	TR250 Carburetor Line Customer to supply Tee (4 Pc.)		
TRF1015	1967-68	TR250 1/4"		
TRC1001	1969-76	TR6 Carburetor Line Customer to supply Tee		

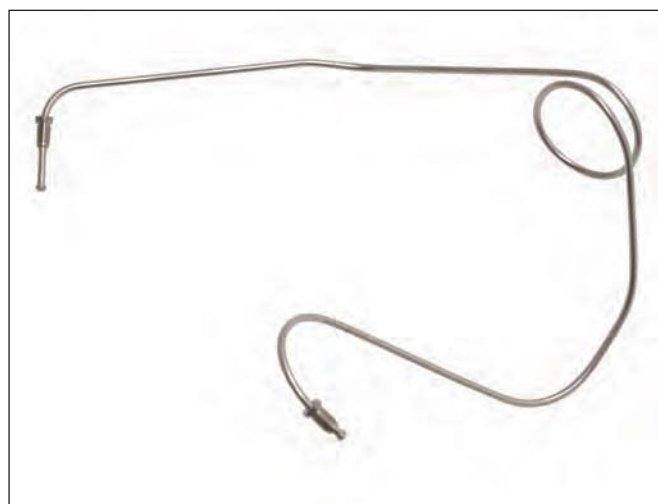

Fuel - Tank To Pump Line			Triumph	
Part No.	Year	Description	O.E. Steel	Stainless Steel
TRF1001	1945-48	TR1800 Right Hand Drive - 5/16"		
TRF1017	1967-70	Spitfire Mark II (2 Pc.)		
TRF1018	1967-68	TR250 (4 Pc.)		
TRF1006	1967-68	TR5 Fuel Injected (4 Pc.) Fuel - Tank Line		
TRF1007	1969-76	TR6 Fuel - Tank Line - 5/16" (4 Pc.)		
TRF1011	1975-81	TR7 Fuel - Tank Line - 5/16" (2 Pc.)		

Hydraulic Clutch Line			Triumph	
Part No.	Year	Description	O.E. Steel	Stainless Steel
TRH1006	1965-67	TR4A		
TRH1005	1967-68	TR250		
TRH1014	1967-70	GT6		
TRH1003	1967-70	Spitfire Mark III		
TRH1005	1969-76	TR6 Clutch Line		
TRH1003	1970-74	Spitfire Mark IV		
TRH1013	1971-73	GT6 (1 Pc.)		
TRH1004	1975-78	TR7		
TRH1003	1975-80	Spitfire 1500		

Miscellaneous & Other Lines			Triumph	
Part No.	Year	Description	O.E. Steel	Stainless Steel
TRH1009	1953-56	TR2 Oil Line		
TRH1009	1953-56	TR3 Oil Line		
TRF1010	1973-76	TR6 Intake Manifold to Vacuum Housing - 1/2"		
TRF1012	1975-81	TR7 Oil Pressure Line - (Reuse Original Fittings)		

### VOLKSWAGEN

Straight Tube Brake Kit			Volkswagen	
Part No.	Year	Description	O.E. Steel	Stainless Steel
VW1001	1950-69	Beetle All Tubing is Straight with Proper Fittings on Each End (8 Pc.) with 1 Union		
VW1002	1968	Beetle Auto Transmission All Tubing is Straight with Proper Fittings on Each End (6 Pc.) Tube Set 1 Union		
VW1002	1969-77	Beetle All Tubing is Straight with Proper Fittings on Each End (6 Pc.) Tube Set 1 Union (from August 1969)		

Fuel - Vapor Line			Volkswagen	
Part No.	Year	Description	O.E. Steel	Stainless Steel
VW01001	1970	Beetle Trailing Arm Lines (2 Pc.)		

### VOLVO

Complete Brake Line Kit			Volvo	
Part No.	Year	Description	O.E. Steel	Stainless Steel
VV1001	1963-66	P-1800S Sport Coupe (6 Pc.) non servo		
VV1004	1969	142-S		
VV1003	1969	1800S Power Disc (18 Pc.)		
VV1002	1970-71	1800E Power Disc (18 Pc.)		
VV1002	1972-73	1800ES Power Disc (18 Pc.)		

Caliper Inlet Lines & Transfer Tubes (Sold in Pairs)			Volvo	
Part No.	Year	Description	O.E. Steel	Stainless Steel
VVD1002	1969-74	140S Inlet Lines		
VVD1001	1970-71	1800E Upper and Lower Inlet lines		
VVD1001	1972-73	1800ES Upper and Lower Inlet lines		

Fuel - Tank To Pump Line			Volvo	
Part No.	Year	Description	O.E. Steel	Stainless Steel
WF1001	1965-69	P-1800S Sport Coupe		

Hydraulic Clutch Line			Volvo	
Part No.	Year	Description	O.E. Steel	Stainless Steel
VVH1001	1963-66	P-1800S All Models		

## STRAIGHT LENGTH / COILS

### Straight Length Tubing

#### Stainless Steel Tubing Up to 20' in Length

Unit price is per inch - Order the quantity you need in inches.

Part No.	Description
SS2001	Stainless Steel Tubing - 1/8" Diameter
SS2002	Stainless Steel Tubing - 3/16" Diameter
SS2003	Stainless Steel Tubing - 1/4" Diameter
SS2004	Stainless Steel Tubing - 5/16" Diameter
SS2005	Stainless Steel Tubing - 3/8" Diameter
SS2006	Stainless Steel Tubing - 1/2" Diameter

#### O.E. Steel Up to 20' in Length

Unit price is per inch - Order the quantity you need in inches.

Part No.	Description
TBW2001	O.E. Steel - 3/16" Diameter
TBW2002	O.E. Steel - 1/4" Diameter
TBW2003	O.E. Steel - 5/16" Diameter
TBW2004	O.E. Steel - 3/8" Diameter

### Pre-Made Lengths With Fittings - All Stainless Steel

#### 3/16" Straight Lengths

Part No.	Description
SS13008	8" Stainless Steel Tubing with 3/8-24 Stainless Steel Fittings
SS13012	12" Stainless Steel Tubing with 3/8-24 Stainless Steel Fittings
SS13020	20" Stainless Steel Tubing with 3/8-24 Stainless Steel Fittings
SS13030	30" Stainless Steel Tubing with 3/8-24 Stainless Steel Fittings
SS13040	40" Stainless Steel Tubing with 3/8-24 Stainless Steel Fittings
SS13051	51" Stainless Steel Tubing with 3/8-24 Stainless Steel Fittings
SS13060	60" Stainless Steel Tubing with 3/8-24 Stainless Steel Fittings
SS13072	72" Stainless Steel Tubing with 3/8-24 Stainless Steel Fittings

#### 1/4" Straight Lengths

Part No.	Description
SS14008	8" Stainless Steel Tubing with 7/6-24 Stainless Steel Fittings
SS14012	12" Stainless Steel Tubing with 7/6-24 Stainless Steel Fittings
SS14020	20" Stainless Steel Tubing with 7/6-24 Stainless Steel Fittings
SS14030	30" Stainless Steel Tubing with 7/6-24 Stainless Steel Fittings
SS14040	40" Stainless Steel Tubing with 7/6-24 Stainless Steel Fittings
SS14051	51" Stainless Steel Tubing with 7/6-24 Stainless Steel Fittings
SS14060	60" Stainless Steel Tubing with 7/6-24 Stainless Steel Fittings
SS14072	72" Stainless Steel Tubing with 7/6-24 Stainless Steel Fittings

#### 5/16" Straight Lengths

Part No.	Description
SS15008	8" Stainless Steel Tubing with 1/2-20 Stainless Steel Fittings
SS15012	12" Stainless Steel Tubing with 1/2-20 Stainless Steel Fittings
SS15020	20" Stainless Steel Tubing with 1/2-20 Stainless Steel Fittings
SS15030	30" Stainless Steel Tubing with 1/2-20 Stainless Steel Fittings



SS15040	40" Stainless Steel Tubing with 1/2-20 Stainless Steel Fittings
SS15051	51" Stainless Steel Tubing with 1/2-20 Stainless Steel Fittings
SS15060	60" Stainless Steel Tubing with 1/2-20 Stainless Steel Fittings
SS15072	72" Stainless Steel Tubing with 1/2-20 Stainless Steel Fittings

#### 3/8" Straight Lengths

Part No.	Description
SS16008	8" Stainless Steel Tubing with 5/8-18 Stainless Steel Fittings
SS16012	12" Stainless Steel Tubing with 5/8-18 Stainless Steel Fittings
SS16020	20" Stainless Steel Tubing with 5/8-18 Stainless Steel Fittings
SS16030	30" Stainless Steel Tubing with 5/8-18 Stainless Steel Fittings
SS16040	40" Stainless Steel Tubing with 5/8-18 Stainless Steel Fittings
SS16051	51" Stainless Steel Tubing with 5/8-18 Stainless Steel Fittings
SS16060	60" Stainless Steel Tubing with 5/8-18 Stainless Steel Fittings
SS16072	72" Stainless Steel Tubing with 5/8-18 Stainless Steel Fittings

### Coils

Tubing in coils is available in Stainless Steel, O.E. Steel, and aluminum (for fuel applications). Stainless steel, original equipment steel is offered without or with fittings (color-coded original steel fittings). All lines are pressure tested and checked for safety.

- Stainless steel tubing is 304 grade, double annealed for easy flaring and bending. Impervious to salt and other corrosive elements, it will maintain its appearance.
- Original Equipment (O.E.) is steel tubing, that is cold-rolled, low-carbon continuously welded. It's protected from the elements by Galvan® galvanizing and a topcoat of aluminum rich epoxy.

#### O.E. Coils

Part No.	Description
C3	O.E. Steel 3/16" x .028 tube - 25 ft. coils
C4	O.E. Steel 1/4" x .028 tube - 25 ft. coils
C5	O.E. Steel 5/16" x .028 tube - 25 ft. coils
C6	O.E. Steel 3/8" x .028 tube - 25 ft. coils

#### Stainless Steel Coils

Part No.	Description
C3S	Stainless Steel 3/16" x .028 tube - 20 ft. coils
C4S	Stainless Steel 1/4" x .028 tube - 20 ft. coils
C5S	Stainless Steel 5/16" x .028 tube - 20 ft. coils
C6S	Stainless Steel 3/8" x .028 tube - 20 ft. coils

#### Aluminum Coils for Fuel Applications

Part No.	Description
AL14	Aluminum Tubing for Fuel Applications - .035 wall, 25 ft. coil - 1/4" Diameter
AL56	Aluminum Tubing for Fuel Applications - .035 wall, 25 ft. coil - 5/16" Diameter
AL38	Aluminum Tubing for Fuel Applications - .035 wall, 25 ft. coil - 3/8" Diameter
AL12	Aluminum Tubing for Fuel Applications - .035 wall, 25 ft. coil - 1/2" Diameter
AL58	Aluminum Tubing for Fuel Applications - .035 wall, 25 ft. coil - 5/8" Diameter

### Tube Coil Kits With Fittings

#### O.E. Steel Coil Kits with O.E. Steel Fittings

Part No.	Description
K3	O.E. Steel 3/16" x .028 tube - 25 ft. coils w/16 assorted Steel ferrule nuts
K4	O.E. Steel 1/4" x .028 tube - 25 ft. coils w/14 assorted Steel ferrule nuts
K5	O.E. Steel 5/16" x .028 tube - 25 ft. coils w/10 assorted Steel ferrule nuts
K6	O.E. Steel 3/8" x .028 tube - 25 ft. coils w/6 assorted Steel ferrule nuts

#### Stainless Steel Coils with O.E. Steel Fittings

Part No.	Description
K3S	Stainless 3/16" x .028 tube - 20 ft. w/16 assorted Steel ferrule nuts
K4S	Stainless 1/4" x .028 tube - 20 ft. w/14 assorted Steel ferrule nuts
K5S	Stainless 5/16" x .028 tube - 20 ft. w/10 assorted Steel ferrule nuts
K6S	Stainless 3/8" x .028 tube - 20 ft. w/6 assorted Steel ferrule nuts

#### Stainless Steel Coil Kits with Stainless Steel Fittings

Part No.	Description
K3SS	Stainless 3/16" x .028 tube - 20 ft. w/16 assorted Stainless ferrule nuts
K4SS	Stainless 1/4" x .028 tube - 20 ft. w/14 assorted Stainless ferrule nuts
K5SS	Stainless 5/16" x .028 tube - 20 ft. w/10 assorted Stainless ferrule nuts
K6SS	Stainless 3/8" x .028 tube - 20 ft. coils w/6 assorted Stainless ferrule nuts

# GRAVEL GUARD / FITTINGS

## Gravel Guard

### Spring Wrap or Armorguard Up to 20 ft. in Length

Unit price is per inch - Order the quantity you need in inches.

#### O.E. Steel

Part No.	Description
AG14350E	O.E. Steel 3/16" Diameter Spring Wrap/Armorguard
AG14400E	O.E. Steel 1/4" Diameter Spring Wrap/Armorguard
AG14450E	O.E. Steel 5/16" Diameter Spring Wrap/Armorguard
AG14500E	O.E. Steel 3/8" Diameter Spring Wrap/Armorguard

#### Stainless Steel

Part No.	Description
AG1435SS	Stainless Steel 3/16" Diameter Spring Wrap/Armorguard
AG1440SS	Stainless Steel 1/4" Diameter Spring Wrap/Armorguard
AG1445SS	Stainless Steel 5/16" Diameter Spring Wrap/Armorguard
AG1450SS	Stainless Steel 3/8" Diameter Spring Wrap/Armorguard

## Insulation Wrap

Unit Price is Per Inch - Order the Quantity You Need in Inches

### White Fiberglass Loom - for Choke Tubes

Part No.	Description
WL8001	1/4" x 18" White Fiberglass Loom
WL8002	1/4" x 8" White Fiberglass Loom
WL8003	1/4" Bulk White Fiberglass Loom

## Fittings

### Tube Nuts - Domestic

Part No.	Description	Tubing Diameter	Color
ST8002	3/8-24 Thread - 7/16" Hex - SAE	3/16" Diameter	Violet
ST8005	3/8-24 Thread - GM Inlet - SAE	3/16" Diameter	Gold
ST8004	3/8-24 Thread - Long - SAE	3/16" Diameter	Gold
ST8003	3/8-24 Thread - Mopar - SAE	3/16" Diameter	Gold
ST8001	3/8-24 Thread - SAE	3/16" Diameter	Gold
SS7001	3/8-24 Thread - SAE	3/16" Diameter	Stainless Steel
ST8006	7/16-24 Thread - SAE	3/16" Diameter	Red
SS7003	7/16-24 Thread - SAE	3/16" Diameter	Stainless Steel
ST8007	1/2-20 Thread - Ford - SAE	3/16" Diameter	Black
ST8008	1/2-20 Thread - GM - SAE	3/16" Diameter	Green
ST8009	1/2-20 Thread - Mopar - SAE	3/16" Diameter	Violet
SS7004	1/2-20 Thread - SAE	3/16" Diameter	Stainless Steel
ST8010	9/16-18 Thread - SAE	3/16" Diameter	Gold
SS7006	9/16-18 Thread - SAE	3/16" Diameter	Stainless Steel
ST8011	9/16-20 Thread - Mopar - SAE	3/16" Diameter	Blue
ST8013	7/16-24 Thread - 9/16" Hex SAE	1/4" Diameter	Gold
ST8014	7/16-24 Thread - Long - SAE	1/4" Diameter	Gold
ST8015	7/16-24 Thread - Mopar - SAE	1/4" Diameter	Gold
ST8012	7/16-24 Thread - SAE	1/4" Diameter	Gold
SS7008	7/16-24 Thread - SAE	1/4" Diameter	Stainless Steel
ST8016	1/2-20 Thread - SAE	1/4" Diameter	Orange
SS7009	1/2-20 Thread - SAE	1/4" Diameter	Stainless Steel
ST8017	9/16-18 Thread - SAE	1/4" Diameter	Blue
SS7010	9/16-18 Thread - SAE	1/4" Diameter	Stainless Steel
ST8019	1/2-20 Thread - GM Long Hex SAE	5/16" Diameter	Black
ST8020	1/2-20 Thread - Female - SAE	5/16" Diameter	Gold
ST8018	1/2-20 Thread - SAE	5/16" Diameter	Gold



ST8021	5/8-18 Thread - SAE	5/16" Diameter	Red
SS7011	1/2-20 Thread - SAE	5/16" Diameter	Stainless Steel
ST8024	3/4-16 Thread - SAE	1/2" Diameter	Gold
ST8023	5/8-18 Thread - Female - SAE	3/8" Diameter	Gold
ST8022	5/8-18 Thread - SAE	3/8" Diameter	Gold
SS7019	5/8-18 Thread - SAE	3/8" Diameter	Stainless Steel

### Tube Nuts - Late Model Domestic and Import

Part No.	Description	Tubing Diameter	Color
SS7031	9mm x 1.0 3/16 SAE Fitting		Stainless Steel
SS7016	10mm x 1 Thread - Female - SAE	3/16" Diameter	Stainless Steel
SS7015	10mm x 1 Thread - SAE or ISO	3/16" Diameter	Stainless Steel
SS7041	10mm x 1 Thread - Male SAE Nissan (Datsun)	3/16" Diameter	Stainless Steel
ST8130	10mm x 1 Thread - Male SAE Nissan (Datsun)	3/16" Diameter	Silver Blue
ST8038	10mm x 1 - Lucas - Female - SAE	3/16" Diameter	Gold
ST8049	10mm x 1.25 - SAE or ISO	3/16" Diameter	Gold
ST8036	10mm x 1 - SAE or ISO	3/16" Diameter	Olive
ST8039	11mm x 1.50 - ISO	3/16" Diameter	Orange
ST8040	12mm x 1 - ISO	3/16" Diameter	Blue
SS7018	12mm x 1 - ISO	3/16" Diameter	Stainless Steel
ST8042	13mm x 1.50 - ISO	3/16" Diameter	Green
ST8045	3/8-20 Thread - SAE or ISO	3/16" Diameter	Silver
SS7013	3/8-24 Thread - Female - SAE	3/16" Diameter	Stainless Steel
SS7012	3/8-24 Thread - SAE or ISO	3/16" Diameter	Stainless Steel
ST8025	3/8-24 Thread - SAE or ISO	3/16" Diameter	Red - Long
ST8028	3/8-24 Thread - Lucas Female SAE	3/16" Diameter	Silver
ST8026	3/8-24 Thread - Lucas SAE or ISO	3/16" Diameter	Silver
ST8027	3/8-24 Thread - Female - SAE	3/16" Diameter	Silver
ST8029	7/16-20 Thread - SAE or ISO	3/16" Diameter	Silver
SS7014	3/8-20 Thread - SAE or ISO	3/16" Diameter	Stainless Steel
ST8031	7/16-20 Thread - Lucas Female SAE	1/4" Diameter	Silver
ST8030	7/16-20 Thread - Lucas SAE or ISO	1/4" Diameter	Silver
ST8048	12mm x 1 - O-Ring Flare	1/4" Diameter	Gold
ST8033	1/2-20 Thread - Lucas Female SAE	5/16" Diameter	Silver
ST8032	1/2-20 Thread - Lucas - SAE or ISO	5/16" Diameter	Silver
ST8046	14mm x 1.50 - O-Ring Flare	5/16" Diameter	Steel
ST8035	5/8-18 Thread - Lucas Female SAE	3/8" Diameter	Silver
ST8034	5/8-18 Thread - Lucas - SAE or ISO	3/8" Diameter	Silver
ST8222	5/8-18 - Male Original Steel Tube Nuts Extended Nose	3/8" Diameter	Steel
ST8047	16mm x 1.50 - O-Ring Flare	3/8" Diameter	Steel
SS7127	-3AN Female Tube Nut and Sleeve Stainless Steel		
SS7132	-4AN Female Tube Nut and Sleeve Stainless Steel		
SS7134	-5AN Female Tube Nut and Sleeve Stainless Steel		
SS7129	-6AN Female Tube Nut and Sleeve Stainless Steel		
SS7136	-8AN Female Tube Nut and Sleeve Stainless Steel		



### Bleeder Screw

Part No.	Description
SS7042	Bleeder Screw Stainless Steel 1-1/8" Long - 3/8-24 Thread

## BRACKETS / CLAMPS / CLIPS

### Brackets, Clamps & Clips

#### Brackets/Clips

Part No.	Description
BRKL-1	Brake Hose Universal Frame Mounting Bracket



BRKL-2	Brake Hose Horseshoe Clip
BRKL-2SS	Brake Hose Horseshoe Clip, Stainless Steel



BRKL-3	Brass Tee 3 Port for 3/16" Line 3/8-24 Thread with Mounting Bracket
--------	---



BRKL-4	Brass Tee 3 Port for 1/4" Line 7/16-24 Thread with Mounting Bracket
--------	---



#### Original Equipment Style Brake & Fuel Tubing Line Clamps

##### All Cars

Part No.	Description
CLP4080	Tubing & Wiring Clamp (1/4")
CLP4040	1940 & Up (3/16")
CLP4050	1940 & Up (1/4")



##### Chrysler

Part No.	Description
CLP4000	1960-69 Chrysler Fuel Line (5/16")
CLP4010	1960-69 Chrysler Fuel Line (3/8")



##### GM

Part No.	Description
CLP4090	1968-81 GM Tube Clamp With Tab (3/16") Yellow
CLP4100	1968-81 GM Tube Clamp With Tab (1/4") Yellow
CLP4110	1968-81 GM Tube Clamp With Tab (5/16") Blue
CLP4120	1968-81 GM Tube Clamp With Tab (3/8") Blue
CLP4130	1968-81 GM Tube Clamp With Tab (1/2") Blue
CLP4020	1968-81 GM Double Tube Clamp With Tab (1/2" & 3/8") Silver
CLP4030	1968-81 GM Double Tube Clamp With Tab (5/16" & 5/16") Black
CLP4140	1968-81 GM Double Tube Clamp With Tab (3/8" & 1/4") Yellow
CLP4060	1968-81 GM Double Tube Clamp With Tab (3/8" & 1/4") Olive
CLP4070	1971-81 GM Double Tube Rear Fuel Clamp (3/8" & 1/4") Silver



#### Mustang / Cougar Brake & Fuel Tubing Line Clamps

Kits include the correct USA made clips, grommets and screws. Factory correct.

Part No.	Description
C5-6	1965-66 Mustang Disc Brakes - 6 Cylinder (19 Pc.)
C5-8	1965-66 Mustang Drum Brakes - 8 Cylinder (21 Pc.)
C5-D	1965-66 Mustang Disc Brakes - 8 Cylinder (21 Pc.)
C7-61	1967 Mustang / Cougar 1 Pc. Rear Fuel - 6 Cylinder (26 Pc.)
C762C	1967 Mustang / Cougar Convertible 2 Pc. - 6 Cylinder (31 Pc.)
C762H	1967 Mustang / Cougar Hardtop 2 Pc. - 6 Cylinder (32 Pc.)
C781	1967 Mustang / Cougar 1 Pc. Rear Fuel - 8 Cylinder (28 Pc.)
C782C	1967 Mustang / Cougar Convertible 2 Pc. - 8 Cylinder (33 Pc.)
C782H	1967 Mustang / Cougar Hardtop 2 Pc. 8 Cylinder (34 Pc.)
C84C	1968 Mustang / Cougar Convertible - 8 Cylinder (32 Pc.)
C86C	1968 Mustang / Cougar Convertible - 6 Cylinder (30 Pc.)
C86H	1968 Mustang / Cougar Hardtop - 6 Cylinder (29 Pc.)
C88C	1968 Mustang / Cougar Convertible - 8 Cylinder (32 Pc.)
C88H	1968 Mustang / Cougar Hardtop - 8 Cylinder (31 Pc.)
C96C	1969 Mustang / Cougar Convertible - 6 Cylinder (32 Pc.)
C96H	1969 Mustang / Cougar Hardtop - 6 Cylinder (31 Pc.)
C98C	1969 Mustang / Cougar Convertible - 8 Cylinder (34 Pc.)
C98H	1969 Mustang / Cougar Hardtop - 8 Cylinder (33 Pc.)
D06C	1970 Mustang / Cougar Convertible 6 Cylinder (36 Pc.)
D06H	1970 Mustang / Cougar Hardtop 6 Cylinder (35 Pc.)
D08C	1970 Mustang / Cougar Convertible 8 Cylinder (37 Pc.)
D08H	1970 Mustang / Cougar Hardtop 8 Cylinder (37 Pc.)
DOCV	1970 Mustang / Cougar Convertible - Vapor 8 Cylinder (38 Pc.)
DOHV	1970 Mustang / Cougar Hardtop - Vapor 8 Cylinder (37 Pc.)
D16DR	1971-73 Mustang / Cougar - 6 Cylinder (41 Pc.)
D18DC	1971-73 Mustang / Cougar Disc Brakes - 8 Cylinder (45 Pc.)
D18DR	1971-73 Mustang / Cougar Drum Brakes - 8 Cylinder (45 Pc.)

#### Single Line Clamps

##### Steel Zinc Plated

Part No.	Description
CLP-1	Rubber Insulated Tubing Line Clamps 3/16"
CLP-2	Rubber Insulated Tubing Line Clamps 1/4"
CLP-3	Rubber Insulated Tubing Line Clamps 5/16"
CLP-4	Rubber Insulated Tubing Line Clamps 3/8"



##### Stainless Steel with Stainless Steel Screws 12 per pack

Part No.	Description
CLPS-1	3/16" - 12 per Pack Includes Stainless Steel Screws
CLPS-2	1/4" - 12 per Pack Includes Stainless Steel Screws
CLPS-3	5/16" - 12 per Pack Includes Stainless Steel Screws
CLPS-4	3/8" - 12 per Pack Includes Stainless Steel Screws
CLPS-5	1/2" - 12 per Pack Includes Stainless Steel Screws



#### Double Line Clamps

##### Stainless Steel with Stainless Steel Screws 6 per pack

Part No.	Description
CLPS-1-1	3/16" - 6 per Pack Includes Stainless Steel Screws
CLPS-2-2	1/4" - 6 per Pack Includes Stainless Steel Screws
CLPS-3-3	5/16" - 6 per Pack Includes Stainless Steel Screws
CLPS-4-4	3/8" - 6 per Pack Includes Stainless Steel Screws
CLPS-5-5	1/2" - 6 per Pack Includes Stainless Steel Screws



**ACCESSORIES / TOOLS**

**Brake Fluids**



Safety Notice: Brake fluid, except for silicone DOT 5, should be changed every year. There is 2% water absorbed into your braking system over a 1-year time period. This is a major safety issue that must be addressed. Don't take any chances – change your brake fluid at least once per year under regular driving conditions.

**Silicone Brake Fluid, DOT 5  
 1103**

Dry Boiling Point 600°F, doesn't harm painted surfaces. Never needs to be replaced. For street or show. Not compatible with regular brake fluid. Sold in 1 quart containers.

**Combination Valves**



**GM Disc/Disc Combination Valve  
 BR9030**

Used on factory 4 wheel disc brake vehicles from 1971 to 1982 to replace original. Also use when adding disc brakes with conversion kits.

**GM Disc/Drum Combination Valve  
 BR9020**

Used on factory front disc/rear drum brake vehicles from 1971 to 1982 to replace original. Also use when adding disc brakes with conversion kits.



**Ford Disc/Drum Combination Valve  
 BR9071**

1970 to July 1972 Mustang - Cougar - Fairlane - Torino Brake Pressure Differential Valve Power Disc with Stop Light Switch

**Adjustable Brake Proportioning Valves**



**Proportioning Valve, Knob Style  
 0707W**

The new generation of adjustable proportioning valves combines the latest refinements to deliver precise pressure metering and strength from a compact forged billet design. Pressure adjustments range from 100-1000 PSI and provide for a maximum decrease of 57% in line pressure, the most of any available valve. Adjuster knob with fine thread tuning provides precise pressure adjustment.

This adjustment lets you fine tune the front to rear braking balance by proportionally decreasing the rear brake line pressure. Valves weigh only 5.2 ounces and have two .25" side mounting holes spaced 1.00" apart. Standard in and out ports are 1/8-27 NPT.



**Combination Proportioning Valve  
 0730W**

Simplifies mounting, plumbing, wiring and brake proportioning adjustments on vehicles with custom brake systems. The combination block maintains full isolation between front and rear fluid circuits and can be used in conjunction with any tandem outlet or dual mount master cylinder assemblies. The rear circuit has a single inlet and

single outlet with the adjustable proportioning valve. The front circuit has a single inlet with two outlets. It can be run as a single outlet with one outlet plugged, or used to split the plumbing on its way to the front calipers.

**Residual Pressure Valves**

Used to retain minimum brake line pressure eliminating excessive brake travel. Available for drum and disc brake applications.

**2 lb. Valve  
 7640**

Used for disc brake systems when the master cylinder is below the horizontal plane of the calipers

**10 lb. Valve  
 7650**

Used for drum brake systems when the master cylinder is below the horizontal plane of the wheel cylinders



**Ford Mustang Accessories**

Part No.	Year	Description
375690-S	1965	Trim Screw Cap Covers For Trunk Screws - Fastback 2+2 - Clear Plastic
380865-S	1966	Trim Screw Cap Covers For Trunk Screws - Fastback 2+2 - Gray Plastic

**Tools**

**Brake Bleeding Kit  
 19200**

Easy to use; includes hose, canister and adapters. One-man brake bleeding kit.



## ACCESSORIES / TOOLS

### Flaring Tools

#### Universal Hydraulic Flaring Tool Kit 7207

This kit fabricates:

- Push Connect Flare: 1/4", 5/16" and 3/8"
- GM Fuel Line Flare: 5/16" and 3/8"
- Single Flare/Double Flare: 3/16", 1/4", 5/16", 3/8" and 1/2"
- Bubble Flaring: 3/16", 1/4", 5/16" and 10mm

Comes in molded box.

For Stainless Steel and other materials. If you've had trouble making flares on Stainless before, you probably had the wrong tool.



### Tube Bending Tools



#### Tube Bending Hand Tool 3755

Bends 3/16", 1/4", 5/16" and 3/8" diameter tubing. Bends up to 135°, featuring long handles for easy bending. Heavy Duty. Made in USA



#### Lever Type Tube Benders For 1/8" to 1/2" O. D. Tubing

These tube benders feature an open side which slips over tube at any point and makes smooth, tight radius bends up to 180° with minimum effort with no scoring or flattening of tubing. It is calibrated to show angle of bend and has a wide hook that grips tubing securely. Each tool bends one size.

Part No.	Tube O.D.	Radius to Center of Tube
3700	1/8"	3/8"
3760	3/16"	7/16"
3765	1/4"	9/16"
3770	5/16"	11/16"
3775	3/8"	15/16"
3780	1/2"	1-1/2"

### Tube Straightener

#### Tube Straightener BQ1025

Straightens tubing coils in preparation for bending. This tool will straighten light-wall tubing coils from 3/16" to 1/2" OD. Simply use the bracket to secure tool with a vise. Feed the coiled tubing into one end and straight tubing will come out the other end. Just cut to the length you need, and you are ready to begin your project.



#### Swivel Handle Tube Benders For 1/4" to 1/2" O. D. Tubing

Features a swivel handle that can be repositioned midway through a bend when both handles begin to meet. This allows easily fabricated bends up to 180° with better control and without the crossing of handles as in most tube benders.

Part No.	Tube O.D.	Radius to Center of Tube
3810	1/4"	9/16"
3815	5/16"	11/16"
3820	3/8"	15/16"
3825	1/2"	1-1/2"

## HOSE KITS - DOMESTICS

Any brake or hydraulic clutch can be fitted with Classic Tube's Pre-Assembled Hose Kits. Included are StopFlex® Stainless Steel Braided Hose in the length you need, along with your choice of hose ends. StopFlex® incorporates a special 3-layer design for superior strength and virtually no volumetric expansion. It starts with a Teflon® PTFE core (liner) followed by the stainless steel braid and a clear vinyl outer cover.

Replacing original equipment rubber hoses with StopFlex® stainless steel braided hoses will increase braking performance by doing away with the soft spongy brake pedal. Rubber hoses expand, with the approximately 1200 psi. generated under hard braking. StopFlex® results show a firmer pedal, allowing more control during braking.

- DOT Compliant for street use
- Minimal volumetric expansion
- Immediate response; not soft as with other hoses
- Corrosion resistant

If factory-correct style is desired, any StopFlex® braided hose kit can also be made in rubber.

### Buick

#### Skylark / GS

Part No.	Year	Description
SBH6001	1967	Front Disc/Rear Drum (3 Pc.)
SBH6002	1968-73	Front Disc/Rear Drum (3 Pc.)

#### Regal / Grand National

Part No.	Year	Description
SBH6003	1973-77	Front Disc/Rear Drum (3 Pc.)
SBH6004	1978-88	Front Disc/Rear Drum (3 Pc.)

### Cadillac

#### Escalade / Escalade EXT

Part No.	Year	Description
SBH6005	1999-00	Front & Rear Disc (3 Pc.)
SBH6282	2000-05	1500 - 4WD Front Disc/Rear Disc (5 Pc.)
SBH6006	2002-04	Front & Rear Disc (5 Pc.)

### Chevrolet

#### Camaro

Part No.	Year	Description
SBH6007	1967-68	Front Drum/Rear Drum (3 Pc.)
SBH6008	1967-68	Front Disc/Rear Drum (3 Pc.)
SBH6009	1969	Z28 - Front & Rear Disc (3 Pc.)
SBH6010	1969-76	Front Disc/Rear Drum (3 Pc.)
SBH6011	1977-81	Z28 - Front Disc/Rear Drum (3 Pc.)
SBH6012	1982-84	Front & Rear Disc (4 Pc.)
SBH6013	1982-84	Z28 - Front Disc/Rear Drum (3 Pc.)
SBH6014	1985-88	Front & Rear Disc (4 Pc.)
SBH6015	1985-88	Front Disc/Rear Disc Hi Perf. (5 Pc.)
SBH6016	1985-88	Z28 - Front Disc/Rear Drum (3 Pc.)
SBH6017	1989-92	Front Disc/Rear Hi Perf (5 Pc.)



SBH6018	1989-92	Z28 - Front Disc/Rear Drum (3 Pc.)
SBH6019	1993-97	Front Disc/Rear Drum (3 Pc.)
SBH6020	1993-97	w/4-wheel disc without traction control (5 Pc.)
SBH6021	1995-97	w/Traction Control - Front & Rear Disc (6 Pc.)
SBH6022	1998-02	without Traction Control - Front & Rear Disc (5 Pc.)
SBH6023	1998-02	w/Traction Control - Front & Rear Disc (6 Pc.)
SBH6339	2010-15	V8 - Disc Brakes (4 Pc.)

#### Cavalier

Part No.	Year	Description
SBH6024	1995-04	Front Disc/Rear Drum (4 Pc.)

#### Chevelle, Malibu, El Camino

Part No.	Year	Description
SBH6025	1967-68	Front Disc/Rear Drum (3 Pc.)
SBH6026	1969-72	Front Disc/Rear Drum (3 Pc.)
SBH6027	1969-72	Front Drum/Rear Drum (3 Pc.)
SBH6028	1978-87	Malibu & El Camino Only - Front Disc/Rear Drum (3 Pc.)

#### Corvette

Part No.	Year	Description
SBH6029	1963-82	Disc (4 Pc.)
SBH6030	1984-87	Disc (4 Pc.)
SBH6031	1988-92	except ZR-1 Disc (4 Pc.)
SBH6032	1994-96	Disc (4 Pc.)
SBH6033	1997-04	including Z06 - Disc (4 Pc.)
SBH6283	2005-06	including Z06 - Disc (4 Pc.)

**Any braided hose kit can also be made in rubber for factory-correct style.**



## HOSE KITS - DOMESTICS

### Impala, Caprice

Part No.	Year	Description
SBH6035	1977-90	Impala - Front Disc/Rear Drum (3 Pc.)
SBH6034	1990-96	Front Disc/Rear Drum (3 Pc.)
SBH6036	1994-96	Impala - SS - Rear Disc (5 Pc.)

### Monte Carlo

Part No.	Year	Description
SBH6441	1962-65	AC Cars Cobra 260 CID and 289 CID
SBH6037	1970-72	Front Disc/Rear Drum (3 Pc.)
SBH6447	1973-74	With F41 Suspension
SBH6038	1978-88	Rear Drum (3 Pc.)

### Nova

Part No.	Year	Description
SBH6039	1969-72	Front Disc/Rear Drum (3 Pc.)
SBH6040	1973-79	Front Disc/Rear Drum (3 Pc.)
SBH6309	1975-79	Front Disc/Rear Drum (3 Pc.)

### Chevy / GMC Truck

#### Blazer

Part No.	Year	Description
SBH6041	1973-78	1500 - 2WD - Front Disc/Rear Drum (3 Pc.)
SBH6043	1973-78	4WD - Front Disc/Rear Drum (3 Pc.)
SBH6042	1979-86	1500 - 2WD - Front Disc/Rear Drum (3 Pc.)
SBH6044	1981-91	4WD - Front Disc/Rear Drum (3 Pc.)
SBH6045	1993-94	2WD (full size) Front Disc/Rear Drum (3 Pc.)
SBH6047	1993-94	4WD (full size) Front Disc/Rear Drum (3 Pc.)
SBH6046	1995-98	2WD (full size) Front Disc/Rear Drum (3 Pc.)

#### Suburban

Part No.	Year	Description
SBH6041	1973-78	1500 - 2WD - Front Disc/Rear Drum (3 Pc.)
SBH6042	1979-86	1500 - 2WD - Front Disc/Rear Drum (3 Pc.)
SBH6462	1996-99	4WD - Front Disc/Rear Drum (3 Pc.)
SBH6057	2000-06	4WD - Front Disc/Rear Disc (5 Pc.)

#### Tahoe, Yukon

Part No.	Year	Description
SBH6046	1995-98	2WD (full size) Front Disc/Rear Drum (3 Pc.)
SBH6048	1995-98	4WD (full size) Front Disc/Rear Drum (3 Pc.)
SBH6462	1996-99	Tahoe 4WD - Front Disc/Rear Drum (3 Pc.)
SBH6057	2000-06	4WD - Front Disc/Rear Disc (5 Pc.)

#### Avalanche

Part No.	Year	Description
SBH6282	2000-05	1500 - 4WD - Front Disc/Rear Drum (5 Pc.)
SBH6056	2001-03	Front & Rear Disc (5 Pc.)

#### 1500

Part No.	Year	Description
SBH6280	1970-72	Rear Coil Spring 2WD Front Disc / Rear Drum (3 Pc.)
SBH6281	1971-72	4WD - Rear Leaf Spring Front Disc / Rear Drum (3 Pc.)
SBH6049	1973	4WD - Front Disc/Rear Drum (3 Pc.)
SBH6041	1973-78	2WD - Front Disc/Rear Drum (3 Pc.)
SBH6050	1974-77	4WD - Front Disc/Rear Drum (3 Pc.)
SBH6051	1978	4WD - Front Disc/Rear Drum (3 Pc.)
SBH6042	1979-86	2WD - Front Disc/Rear Drum (3 Pc.)
SBH6052	1979-87	4WD - Front Disc/Rear Drum (3 Pc.)
SBH6282	2000-05	(5 Pc.) Avalanche



#### 1500 & 2500

Part No.	Year	Description
SBH6053	1988-98	2WD - Front Disc/Rear Drum (3 Pc.)
SBH6055	1988-98	4WD - Front Disc/Rear Drum (3 Pc.)

#### S-10 Blazer, S-10 Pick Up

Part No.	Year	Description
SBH6059	1982-91	2WD (Early 91) Front Disc/Rear Drum (3 Pc.)
SBH6061	1982-91	4WD (Early 91) Front Disc/Rear Drum (3 Pc.)
SBH6460	1988-98	Pick Up (3 Pc.) with Dual Rear Wheels
SBH6060	1991-98	2WD (Late 91 - Up) Front Disc/Rear Drum (3 Pc.)
SBH6062	1991-98	4WD (Late 91) Front Disc/Rear Drum (3 Pc.)
SBH6462	1996-99	Chevy - GMC - Pick Up 4WD - Front Disc/Rear Drum (3 Pc.)
SBH6063	1999-04	ZR-2 Package, 4WD - Front Disc/Rear Drum (3 Pc.)
SBH6064	1999-04	Extreme Package, 2WD - Front Disc/Rear Drum (3 Pc.)

#### Misc. Chevy / GMC Trucks

Part No.	Year	Description
SBH6459	1981-87	1500 (3 Pc.)
SBH6054	1988-98	3500 Except '88 old body - 2WD Front Disc/Rear Drum (3 Pc.)
SBH6056	1999-06	1500 2WD & 4WD - Front & Rear Disc (5 Pc.)
SBH6058	2001-06	2500/3500 Heavy Duty 2WD & 4WD Front Disc/Rear Disc (5 Pc.)

#### Chrysler

#### PT Cruiser

Part No.	Year	Description
SBH6065	2001-04	With ABS - Rear Disc (4 Pc.)
SBH6066	2001-04	Rear Drum (4 Pc.)
SBH6067	2002-04	Turbo - Rear Disc (4 Pc.)

#### Dodge

#### Challenger

Part No.	Year	Description
SBH6069	1970-72	Front Disc/Rear Drum (3 Pc.)
SBH6070	1973-74	Front Disc/Rear Drum (3 Pc.)

## HOSE KITS - DOMESTICS

### Charger

Part No.	Year	Description
SBH6071	1966-67	Front Disc/Rear Drum (3 Pc.)
SBH6072	1970-77	Front Disc/Rear Drum (3 Pc.)

### Dart

Part No.	Year	Description
SBH6073	1966-69	Front Disc/Rear Drum (3 Pc.)
SBH6074	1970-72	Front Disc/Rear Drum (3 Pc.)
SBH6075	1973-76	Front Disc/Rear Drum (3 Pc.)

### Neon

Part No.	Year	Description
SBH6076	1994-03	Front & Rear Disc (4 Pc.)
SBH6077	2004-06	SRT-4 Front & Rear Disc (4 Pc.)

### Stealth

Part No.	Year	Description
SBH6078	1991-95	2WD - Rear Disc (4 Pc.)

### Viper

Part No.	Year	Description
SBH6079	1992-02	(4 Pc.)
SBH6273	1996-00	Rear Disc (4 Pc.)
SBH6274	2001-02	Rear Disc (4 Pc.)
SBH6275	2003-09	(4 Pc.)

### Dodge Truck

#### Dakota

Part No.	Year	Description
SBH6284	1987-88	1500 2WD (3 Pc.) Dakota
SBH6286	1997-99	1500 4WD (3 Pc.) Dakota
SBH6301	1997-01	2WD (3 Pc.)
SBH6285	2000-02	1500 4WD (3 Pc.) Dakota

#### Durango

Part No.	Year	Description
SBH6287	2000-02	1500 4WD (3 Pc.) Durango

#### Ram

Part No.	Year	Description
SBH6080	1994-99	1500, 2500 - 2WD - Front Disc/Rear Drum (3 Pc.)
SBH6081	1994-99	1500, 2500 - 4WD - Front Disc/Rear Drum (3 Pc.)
SBH6288	2000-02	1500 4WD Front Disc / Rear Drum (3 Pc.) 1500 & 2500
SBH6082	2002-04	1500, 2500 - 4WD - Front Disc/Rear Drum (3 Pc.)
SBH6272	2002-05	1500 2WD without ABS (Using Factory Brackets and Blocks) Front & Rear Disc (5 Pc.) 1500 & 2500



### Eagle

#### Talon

Part No.	Year	Description
SBH6083	1990-94	2WD - Rear Disc (4 Pc.)

### Ford

#### Crown Victoria

Part No.	Year	Description
SBH6289	2003-05	Rear Disc (4 Pc.)

#### Focus

Part No.	Year	Description
SBH6084	2000-04	Front Disc/Rear Drum (4 Pc.)
SBH6085	2002-04	SVT - Front & Rear Disc (6 Pc.)
SBH6463	2012-13	(4 Pc.)

#### Fusion

Part No.	Year	Description
SBH6465	2013-14	(4 Pc.)

#### Mustang

Part No.	Year	Description
SBH6086	1965-66	Front & Rear Disc with Dual Exhaust, GT, Hipo, Shelby - Includes Brackets (3 Pc.)
SBH6305	1965-66	Front & Rear Disc with Single Exhaust Includes Brackets (3 Pc.)
SBH6087	1967	Front Disc/Rear Drum - Includes Brackets (3 Pc.)
SBH6088	1968-69	Front Disc/Rear Drum - 28 Spline - Includes Brackets (3 Pc.)
SBH6311	1968-69	Front Disc/Rear Drum - 31 Spline - Includes Brackets (3 Pc.)
SBH6306	1970	Front Disc with brackets (3 Pc.)
SBH6089	1971-73	Front Disc/Rear Drum (3 Pc.)
SBH6090	1974-78	Front Disc/Rear Drum (3 Pc.)
SBH6091	1979-86	Front Disc/Rear Drum (3 Pc.)
SBH6092	1984	SVO - Front Disc/Rear Disc (5 Pc.)
SBH6093	1985-86	SVO - Front Disc / Rear Disc (5 Pc.)
SBH6094	1987-93	Front Disc/Rear Drum (3 Pc.)
SBH6095	1994-95	Cobra - Front & Rear Disc (5 Pc.)
SBH6096	1994-95	GT - Front & Rear Disc (5 Pc.)
SBH6097	1996-98	GT - Front & Rear Disc (4 Pc.)
SBH6098	1999-04	6 Cyl. & GT w/4 Wheel ABS Front & Rear Disc (4 Pc.)
SBH6099	1999-04	Cobra (w/IRS) - Front & Rear Disc (4 Pc.)
SBH6100	1999-04	6 Cyl. & GT without ABS - Front & Rear Disc (4 Pc.)
SBH6101	2005-14	GT - Front & Rear Disc (4 Pc.)
SBH6464	2015-17	(4 Pc.)

#### Probe

Part No.	Year	Description
SBH6102	1988-92	GT - Front Disc (4 Pc.)

#### Taurus

Part No.	Year	Description
SBH6103	1989-95	Sedan and Wagon - Front & Rear Disc (4 Pc.)
SBH6104	1989-95	SHO - Front & Rear Disc (4 Pc.)

#### Thunderbird

Part No.	Year	Description
SBH6304	1987-88	Turbo Coupe - Front & Rear Disc (5 Pc.)

### Ford Truck

#### Bronco

Part No.	Year	Description
SBH6105	1967-73	4WD - Front & Rear Drum (4 Pc.)
SBH6106	1974-75	4WD - Front Disc/Rear Drum (4 Pc.)
SBH6107	1976-77	4WD - Front Disc/Rear Drum (4 Pc.)
SBH6108	1978-79	4WD (full size) - Front Disc/Rear Drum (4 Pc.) includes Front Axle Hardlines
SBH6290	1989	2WD & 4WD (3 Pc.)

## HOSE KITS - DOMESTICS

Excursion		
Part No.	Year	Description
SBH6298	2000-05	4WD (5 Pc.)

Expedition		
Part No.	Year	Description
SBH6294	1997-02	4WD (5 Pc.)
SBH6299	2003-05	2WD (5 Pc.)

Explorer		
Part No.	Year	Description
SBH6109	1991-94	Front Disc/Rear Drum (3 Pc.)
SBH6292	1996-01	4WD (4 Pc.)

F-150		
Part No.	Year	Description
SBH6291	1973-77	4WD Includes Axle Hardlines (4 Pc.)
SBH6112	1977-79	4WD - Front Disc/Rear Drum (4 Pc.) includes Front Axle Hardlines
SBH6113	1980-89	2WD & 4WD - Front Disc/Rear Drum (3 Pc.)
SBH6114	1990-93	2WD & 4WD - Front Disc/Rear Drum (3 Pc.)
SBH6110	1994-96	F-100/ F-150 - 2WD & 4WD Front Disc/Rear Drum (3 Pc.)
SBH6111	1996-98	Late '96 - F150/F250 - 2WD Front Disc/Rear Drum (3 Pc.)
SBH6293	1996-98	2WD (5 Pc.)
SBH6295	1996-98	4WD (5 Pc.)
SBH6115	2004-06	4WD - Front & Rear Disc (6 Pc.) Includes Axle Hardlines

F-250		
Part No.	Year	Description
SBH6116	1977-79	Front Disc/Rear Drum (Except Super Duty) (3 Pc.) 4WD
SBH6117	1980-89	4WD - Front Disc/Rear Drum (3 Pc.)
SBH6118	1990-94	4WD - Front Disc/Rear Drum (3 Pc.)
SBH6119	1995-96	4WD - Front Disc/Rear Drum (3 Pc.)
SBH6120	1997-99	4WD - Front Disc/Rear Drum (3 Pc.)
SBH6121	1997-99	4WD - Front & Rear Disc (4 Pc.)
SBH6122	1999-02	2WD - Super Duty - Rear Disc ABS (4 Pc.)
SBH6308	1999-02	4WD - Super Duty - Rear Disc ABS (4 Pc.)
SBH6307	2003-06	2WD - Super Duty - Rear Disc ABS (4 Pc.)
SBH6303	2003-06	4WD - Super Duty - Rear Disc ABS (4 Pc.)

F-150 Lightning		
Part No.	Year	Description
SBH6123	1999-03	Front & Rear Disc (5 Pc.) Includes Axle Hardlines

Ranger		
Part No.	Year	Description
SBH6296	1998-00	2WD (3 Pc.)
SBH6297	1998-00	4WD (3 Pc.)

### Mercury

Cougar		
Part No.	Year	Description
SBH6087	1967	Front Disc/Rear Drum - Includes Brackets (3 Pc.)
SBH6088	1968-69	Front Disc/Rear Drum - 28 Spline Includes Brackets (3 Pc.)
SBH6311	1968-69	Front Disc/Rear Drum - 31 Spline Includes Brackets (3 Pc.)
SBH6306	1970	Front Disc - Includes Brackets (3 Pc.)
SBH6089	1971-73	Front Disc/Rear Drum (3 Pc.)

Marauder		
Part No.	Year	Description
SBH6289	2003-05	(4 Pc.)



### Jeep

CJ5 / CJ7 / CJ8		
Part No.	Year	Description
SBH6124	1976-81	CJ5/CJ7 Only - Stock Height to 1" Lift (3 Pc.)
SBH6125	1982-86	Stock Height to 1" Lift (3 Pc.)

Commando		
Part No.	Year	Description
SBH6278	1968-71	(3 Pc.)

Wagoneer		
Part No.	Year	Description
SBH6126	1987-91	(3 Pc.)

Wagoneer / Cherokee		
Part No.	Year	Description
SBH6127	1976-86	J20/J10 - Narrow Track (3 Pc.)
SBH6128	1979-86	J20/J10 - Wide Track (3 Pc.)
SBH6279	1988	Cherokee Only (3 Pc.)
SBH6276	1990-01	Cherokee Only 4WD (3 Pc.)

Wrangler		
Part No.	Year	Description
SBH6129	1987-95	YJ (3 Pc.)
SBH6130	1997-06	TJ (3 Pc.)

Liberty		
Part No.	Year	Description
SBH6301	2002-06	TJ (3 Pc.)

### Hummer

Hummer H2		
Part No.	Year	Description
SBH6131	2003-06	(6 Pc.)

# HOSE KITS - DOMESTICS

## Oldsmobile

### Alero

Part No.	Year	Description
SBH6134	1999-04	Front & Rear Disc (4 Pc.)

### Cutlass / 442

Part No.	Year	Description
SBH6135	1967	Front Disc/Rear Drum (3 Pc.)
SBH6136	1968-72	Front Disc/Rear Drum (3 Pc.)
SBH6137	1973-77	Front Disc/Rear Drum (3 Pc.)
SBH6138	1978-88	Front Disc/Rear Drum (3 Pc.)

## Plymouth

### Barracuda

Part No.	Year	Description
SBH6139	1966-70	Front Drum/Rear Drum (3 Pc.)
SBH6140	1971-74	Front Disc/Rear Drum (3 Pc.)

### Duster

Part No.	Year	Description
SBH6073	1966-69	Front Disc/Rear Drum (3 Pc.)
SBH6074	1970-72	Front Disc/Rear Drum (3 Pc.)
SBH6075	1973-76	Front Disc/Rear Drum (3 Pc.)

### Laser

Part No.	Year	Description
SBH6144	1990-94	2WD - Front & Rear Disc (4 Pc.)

### Prowler

Part No.	Year	Description
SBH6300	1997-02	(4 Pc.)

### Road Runner

Part No.	Year	Description
SBH6145	1967-69	Front Drum/Rear Drum (3 Pc.)
SBH6146	1970-75	Front Disc/Rear Drum (3 Pc.)

## Pontiac

### Fiero

Part No.	Year	Description
SBH6147	1984-87	Front & Rear Disc (4 Pc.)

### Firebird / Trans Am

Part No.	Year	Description
SBH6008	1967-68	Front Disc/Rear Drum (3 Pc.)
SBH6010	1969-76	Front Disc/Rear Drum (3 Pc.)
SBH6150	1977-78	Front Disc/Rear Drum (3 Pc.)
SBH6151	1978-81	Front & Rear Disc (3 Pc.)
SBH6152	1982-83	Front Disc/Rear Disc (4 Pc.)
SBH6013	1982-84	Front Disc/Rear Drum (3 Pc.)
SBH6154	1984-87	Front & Rear Disc (3 Pc.)
SBH6016	1985-88	Front Disc/Rear Drum (3 Pc.)
SBH6015	1985-88	Front & Rear Disc (5 Pc.) Hi Perf.
SBH6157	1988-92	Front Disc/Rear Drum (3 Pc.)
SBH6017	1989-92	Front & Rear Disc (5 Pc.) Hi Perf.
SBH6159	1993-97	Front Disc/Rear Drum (3 Pc.)
SBH6020	1993-97	4-Wheel Disc without Traction Control Front & Rear Disc (5 Pc.)
SBH6021	1995-97	With Traction Control - Front & Rear Disc (6 Pc.)
SBH6022	1998-02	Without Traction Control - Front & Rear Disc (5 Pc.)
SBH6023	1998-02	With Traction Control - Front & Rear Disc (6 Pc.)

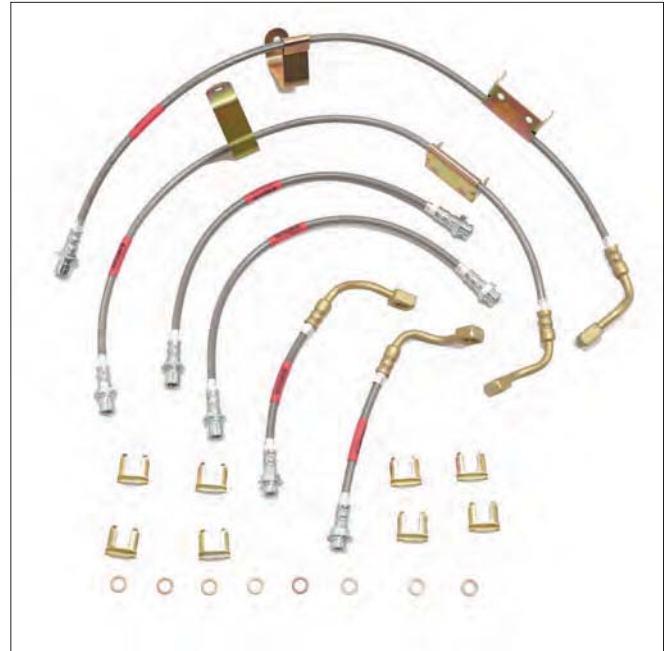

### Grand Am

Part No.	Year	Description
SBH6164	1979-81	Front Disc/Rear Drum (3 Pc.)

### Grand Prix

Part No.	Year	Description
SBH6165	1978-88	Front Disc/Rear Drum (3 Pc.)

### GTO / LeMans / Tempest

Part No.	Year	Description
SBH6166	1967-68	GTO with Front Disc (3 Pc.)
SBH6166	1967-68	Lemans with Front Disc (3 Pc.)
SBH6167	1969-72	GTO with Front Disc (3 Pc.)
SBH6167	1969-72	Lemans with Front Disc (3 Pc.)
SBH6168	1969-72	GTO with Front Drum (3 Pc.)
SBH6168	1969-72	Lemans with Front Drum (3 Pc.)
SBH6169	1973	GTO (3 Pc.)
SBH6169	1973	Lemans (3 Pc.)
SBH6170	1974	GTO (3 Pc.)
SBH6170	1974-77	Tempest (3 Pc.)
SBH6171	2004-06	GTO (3 Pc.)

### Sunfire

Part No.	Year	Description
SBH6172	1995-04	Front Disc/Rear Drum (4 Pc.)

## HOSE KITS - IMPORTS

### Acura

Part No.	Year	Description
SBH6178	1991-94	NSX All Models - Front & Rear Disc (4 Pc.)
SBH6177	1991-95	Legend All Models - Front & Rear Disc (4 Pc.)
SBH6179	1999-03	TL/CL 3.2L Including Type S Front & Rear Disc (4 Pc.)
SBH6181	2002-04	RSX Coupe (including Type S) Front & Rear Disc (4 Pc.)
SBH6180	2003-04	TSX Front & Rear Disc (4 Pc.)

### Integra

Part No.	Year	Description
SBH6173	1990-93	RS, LS, GS, and GSR - Front & Rear Disc (4 Pc.)
SBH6174	1994-97	LS and GSR - Front & Rear Disc (4 Pc.)
SBH6176	1997-01	Type R - Front & Rear Disc (4 Pc.)
SBH6175	1998-01	LS and GSR - Front & Rear Disc (4 Pc.)

### BMW

Part No.	Year	Description
SBH6182	1969-76	2002 Rear Disc (4 Pc.)
SBH6183	1975-79	530i Rear Disc (4 Pc.)
SBH6185	1978-83	733i, 735 Rear Disc (4 Pc.)
SBH6184	1979-81	528 Rear Disc (4 Pc.)
SBH6186	1983-88	633csi Rear Disc (4 Pc.)
SBH6187	1983-95	318i Rear Disc (4 Pc.)

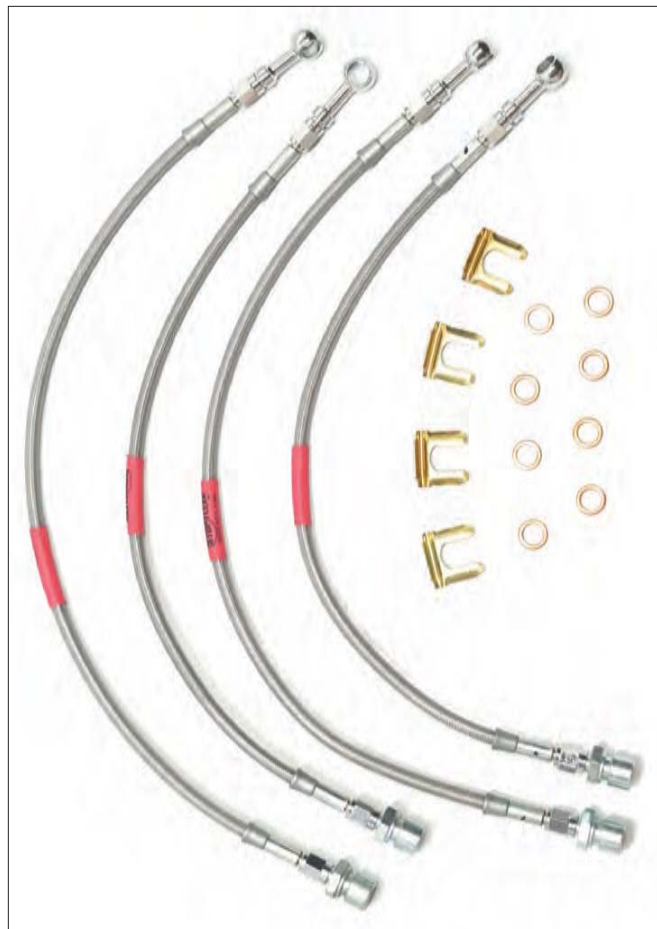

### Mini

### Cooper

Part No.	Year	Description
SBH6188	2003-06	Rear Disc (4 Pc.)

### Honda

### Accord

Part No.	Year	Description
SBH6189	1992-97	Front Disc/Rear Drum (4 Pc.)
SBH6192	1992-97	Front Disc/Rear Disc (6 Pc.)
SBH6190	1998-02	4 Cyl. - Front Disc/Rear Drum (4 Pc.)
SBH6191	1998-02	Front & Rear Disc (4 Pc.)

### Civic

Part No.	Year	Description
SBH6193	1988-91	CRX - Front Disc/Rear Drum (4 Pc.)
SBH6194	1988-91	EX, Si, CRX Si - Front & Rear Disc (4 Pc.)
SBH6195	1992-95	(No ABS) Front & Rear Disc (4 Pc.)
SBH6196	1992-95	Front Disc/Rear Drum (4 Pc.)
SBH6197	1996-00	CX, DX, HX (sm. Front rotor) Front & Rear Disc (4 Pc.)
SBH6198	1996-00	LX, EX (with large front rotor) Front & Rear Disc (4 Pc.)
SBH6199	1999-02	Coupe Si - Front & Rear Disc (4 Pc.)
SBH6200	2001-04	EX, LX, DX - Front Disc/Rear Drum (4 Pc.)
SBH6201	2003-04	Hatchback Si - Front & Rear Disc (4 Pc.)

### Prelude

Part No.	Year	Description
SBH6202	1992-06	Front & Rear Disc (4 Pc.)
SBH6203	1997-98	Base Model - Front & Rear Disc (4 Pc.)
SBH6204	1997-98	SH Model Front & Rear Disc (4 Pc.)

### S-2000

Part No.	Year	Description
SBH6205	2000-03	Front & Rear Disc (4 Pc.)

### Truck (Imported) CRV

Part No.	Year	Description
SBH6206	1997-01	All Models (3 Pc.)

### Infiniti

Part No.	Year	Description
SBH6207	1990-96	Q-45 Rear Disc (4 Pc.)
SBH6208	2003-04	G35 Coupe & Sedan Standard Disc & Rear Disc (4 Pc.)
SBH6209	2003-04	Q35 Coupe & Sedan With Brembo Brakes & Rear Disc (4 Pc.)

### Lexus

### IS300

Part No.	Year	Description
SBH6210	2001-04	Rear Disc (4 Pc.)

### Mazda

### RX-7

Part No.	Year	Description
SBH6212	1981-85	Rear Disc (4 Pc.)
SBH6213	1986-92	Rear Disc (4 Pc.)
SBH6214	1993-95	Rear Disc (4 Pc.)

## HOSE KITS - IMPORTS

### Miata MX-5

Part No.	Year	Description
SBH6211	1990-97	Rear Disc ( 4 Pc.)

### Mazdaspeed Protégé

Part No.	Year	Description
SBH6215	2003-06	Rear Disc (4 Pc.)

### Mitsubishi

#### 3000GT

Part No.	Year	Description
SBH6216	1991-99	2WD - Front & Rear Disc (4 Pc.)

#### Eclipse

Part No.	Year	Description
SBH6217	1990-94	2 WD Front & Rear Disc (4 Pc.)
SBH6218	1995-99	2 WD & All WD Rear Drums & Front Disc / Rear Drum (4 Pc.)
SBH6219	1995-99	2 WD & All WD Front & Rear Disc (4 Pc.)
SBH6220	2000-03	2 WD Front & Rear Disc (4 Pc.)

#### Lancer Evolution

Part No.	Year	Description
SBH6221	2003-04	Front & Rear Disc (4 Pc.)

### Nissan

#### 240SX

Part No.	Year	Description
SBH6224	1970-73	Front Disc / Rear Drum (4 Pc.)
SBH6225	1974	Front Disc / Rear Drum (4 Pc.)
SBH6226	1975-78	Front Disc / Rear Drum (4 Pc.)
SBH6222	1989-04	Front & Rear Disc (4 Pc.)
SBH6223	1995-08	Front & Rear Disc (4 Pc.)

#### 240Z

Part No.	Year	Description
SBH6224	1970-73	Front Disc/Rear Drum (4 Pc.)
SBH6225	1974	Front Disc/Rear Drum (4 Pc.)
SBH6226	1975-78	Front Disc/Rear Drum (4 Pc.)

#### 280-ZX

Part No.	Year	Description
SBH6227	1979-81	Front & Rear Disc (4 Pc.)

#### 300-ZX

Part No.	Year	Description
SBH6228	1984-89	Front & Rear Disc (4 Pc.)
SBH6229	1990-96	Front & Rear Disc (4 Pc.)

#### 350-Z1

Part No.	Year	Description
SBH6230	2003-06	With Standard Brakes - Front & Rear Disc (4 Pc.)
SBH6231	2003-06	With Brembo Brakes Front & Rear Disc (4 Pc.)

#### 510

Part No.	Year	Description
SBH6232	1968-73	Front & Rear Disc (4 Pc.)



### Maxima

Part No.	Year	Description
SBH6233	1989-94	Front & Rear Disc or Drum (4 Pc.)
SBH6234	1995-96	Front Disc / Rear Disc or Drum (4 Pc.)

### Sentra

Part No.	Year	Description
SBH6235	1991-94	Rear Drum (4 Pc.)
SBH6302	1991-94	Rear Disc (4 Pc.)
SBH6236	1995-98	Front Disc / Rear Drum (4 Pc.)
SBH6237	2002-04	SE-R (Including Spec V) Front & Rear Disc (4 Pc.)

### Nissan Truck

#### Frontier

Part No.	Year	Description
SBH6238	1998-04	2WD Desert Runner and 4WD (3 Pc.)

#### Titan

Part No.	Year	Description
SBH6239	2004	4WD with Traction Control (6 Pc.)

#### X-Terra

Part No.	Year	Description
SBH6240	2000-06	2WD & 4WD (3 Pc.)

## HOSE KITS - IMPORTS

### Porsche

356		
Part No.	Year	Description
SBH6241	1955-59	A Model - Front & Rear Disc (4 Pc.)
SBH6242	1960-65	B/C Model - Front & Rear Disc (4 Pc.)

911 / 912		
Part No.	Year	Description
SBH6243	1965-68	Front & Rear Disc (4 Pc.)
SBH6244	1969-75	(Early 75) Front & Rear Disc (4 Pc.)

911 / 913		
Part No.	Year	Description
SBH6245	1975-83	(Late '75) Front & Rear Disc (4 Pc.)

914		
Part No.	Year	Description
SBH6246	1970-76	Front & Rear Disc (4 Pc.)

924		
Part No.	Year	Description
SBH6247	1976-82	Front & Rear Disc (4 Pc.)
SBH6248	1981-88	S/Turbo - Front & Rear Disc (4 Pc.)

928		
Part No.	Year	Description
SBH6249	1978-89	Front & Rear Disc (4 Pc.)



944		
Part No.	Year	Description
SBH6253	1978-81	Front & Rear Disc (4 Pc.)
SBH6250	1983-86	Front & Rear Disc (4 Pc.)
SBH6251	1986	Turbo - Front & Rear Disc (4 Pc.)
SBH6252	1987-89	Front & Rear Disc (4 Pc.)
SBH6253	1987-89	Front & Rear Disc (4 Pc.)
SBH6254	1987-89	Turbo - Front & Rear Disc (4 Pc.)

### Toyota Truck

4-Runner		
Part No.	Year	Description
SBH6255	1995-02	(Nov. '95-'02) - 2WD & 4WD (3 Pc.)

Tacoma		
Part No.	Year	Description
SBH6256	1995-06	Except 4-Runner 2 WD (3 Pc.)
SBH6257	1995-06	4WD (3 Pc.)
SBH6258	1998-06	Tacoma and 4-Runner 2 WD (3 Pc.)

Tundra		
Part No.	Year	Description
SBH6259	2000-06	2WD & 4WD (3 Pc.)

Land Cruiser		
Part No.	Year	Description
SBH6260	1970-75	Through August 1975 (4 Pc.)
SBH6261	1975-83	(1pc) Clutch Flex Line

### Volkswagen

Cabriolet		
Part No.	Year	Description
SBH6262	1985-93	Front Disc / Rear Drum (4 Pc.)
SBH6263	1990-95	Front Disc / Rear Drum (4 Pc.)

Corrado		
Part No.	Year	Description
SBH6263	1990-95	Front Disc/Rear Drum (4 Pc.)

Golf/Jetta		
Part No.	Year	Description
SBH6264	1985-93	Front Disc Brakes (4 Pc.)
SBH6265	1992-96	16 valve - Front & Rear Disc (6 Pc.)

GTI		
Part No.	Year	Description
SBH6267	1985-93	GTI - only Front Disc/N/A (4 Pc.)
SBH6266	1996-99	GTI w/VR6 - Front & Rear Disc (6 Pc.)

Rabbit		
Part No.	Year	Description
SBH6268	1974-84	Front Disc/Rear Drum (4 Pc.)
SBH6269	1974-84	(US built) Front Disc/Rear Drum (4 Pc.)

Scirocco		
Part No.	Year	Description
SBH6270	1974-80	Front Disc/Rear Drum (4 Pc.)
SBH6271	1981-84	Front Disc/Rear Drum (4 Pc.)

## PRE-MADE HOSE SECTIONS

**10mm (3/8") 30° Banjo to Straight -3AN Female**

Part No	Length
SBH3306	6
SBH3308	8
SBH3310	10
SBH3312	12
SBH3314	14
SBH3316	16
SBH3318	18
SBH3320	20
SBH3322	22
SBH3324	24
SBH3326	26
SBH3328	28
SBH3330	30
SBH3332	32
SBH3334	34
SBH3336	38
SBH3338	38
SBH3340	40
SBH3342	42
SBH3344	44
SBH3346	46
SBH3348	48
SBH3350	50
SBH3352	52
SBH3354	54
SBH3356	56
SBH3358	58
SBH3360	60



**10mm (3/8") 90° Banjo to Straight -3AN Female**

Part No	Length
SBH4306	6
SBH4308	8
SBH4310	10
SBH4312	12
SBH4314	14
SBH4316	16
SBH4318	18
SBH4320	20
SBH4322	22
SBH4324	24
SBH4326	26
SBH4328	28
SBH4330	30
SBH4332	32
SBH4334	34
SBH4336	36
SBH4338	38
SBH4340	40
SBH4342	42
SBH4344	44
SBH4346	46
SBH4348	48
SBH4350	50
SBH4352	52
SBH4354	54
SBH4356	56
SBH4358	58
SBH4360	60



**10mm (3/8") Straight Banjo to Straight -3AN Female**

Part No	Length
SBH2306	6
SBH2308	8
SBH2310	10
SBH2312	12
SBH2314	14
SBH2316	16
SBH2318	18
SBH2320	20
SBH2322	22
SBH2324	24
SBH2326	26
SBH2328	28
SBH2330	30
SBH2332	32
SBH2334	34
SBH2336	36
SBH2338	38
SBH2340	40
SBH2342	42
SBH2344	44
SBH2346	46
SBH2348	48
SBH2350	50
SBH2352	52
SBH2354	54
SBH2356	56
SBH2358	58
SBH2360	60



**11mm (7/16") 30° Banjo to Straight -3AN Female**

Part No	Length
SBH3406	6
SBH3408	8
SBH3410	10
SBH3412	12
SBH3414	14
SBH3416	16
SBH3418	18
SBH3420	20
SBH3422	22
SBH3424	24
SBH3426	26
SBH3428	28
SBH3430	30
SBH3432	32
SBH3434	34
SBH3436	36
SBH3438	38
SBH3440	40
SBH3442	42
SBH3444	44
SBH3446	46
SBH3448	48
SBH3450	50
SBH3452	52
SBH3454	54
SBH3456	56
SBH3458	58
SBH3460	60



**11mm (7/16") 90° Banjo to Straight -3AN Female**

Part No	Length
SBH4406	6
SBH4408	8
SBH4410	10
SBH4412	12
SBH4414	14
SBH4416	16
SBH4418	18
SBH4420	20
SBH4422	22
SBH4424	24
SBH4426	26
SBH4428	28
SBH4430	30
SBH4432	32
SBH4434	34
SBH4436	36
SBH4438	38
SBH4440	40
SBH4442	42
SBH4444	44
SBH4446	46
SBH4448	48
SBH4450	50
SBH4452	52
SBH4454	54
SBH4456	56
SBH4458	58
SBH4460	60



**11mm (7/16") Straight Banjo to Straight -3AN Female**

Part No	Length
SBH2406	6
SBH2408	8
SBH2410	10
SBH2412	12
SBH2414	14
SBH2416	16
SBH2418	18
SBH2420	20
SBH2422	22
SBH2424	24
SBH2426	26
SBH2428	28
SBH2430	30
SBH2432	32
SBH2434	34
SBH2436	36
SBH2438	38
SBH2440	40
SBH2442	42
SBH2444	44
SBH2446	46
SBH2448	48
SBH2450	50
SBH2452	52
SBH2454	54
SBH2456	56
SBH2458	58
SBH2460	60



**Straight -3AN Female to Straight -3AN Female**

Part No	Length
SBH1306	6
SBH1308	8
SBH1310	10
SBH1312	12
SBH1314	14
SBH1316	16
SBH1318	18
SBH1320	20
SBH1322	22
SBH1324	24
SBH1326	26
SBH1328	28
SBH1330	30
SBH1332	32
SBH1334	34
SBH1336	36
SBH1338	38
SBH1340	40
SBH1342	42
SBH1344	44
SBH1346	46
SBH1348	48
SBH1350	50
SBH1352	52
SBH1354	54
SBH1356	56
SBH1358	58
SBH1360	60



## FITTINGS

### Frame End Fittings

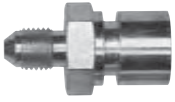

Part No.	Description
SBH8001	-3AN Male to Female 3/8 x 24 Inverted Convex
SBH8002	-3AN Male to Female 7/16 x 24 Inverted Convex
SBH8003	-3AN Male to Female 10mm x 1.0 ISO. Flare Concave
SBH8004	-3AN Male to Female 10mm x 1.0 Inverted Flare Convex
SBH8069	-3AN Male to Female 12mm x 1.0 ISO Flare Concave



### Frame End Fittings

Part No.	Description
SBH8088	-3AN Male to 3/8 x 24 Inverted Bulkhead - 1/2 x 20 Flare
SBH8023	-3AN Male to 3/8 x 24 Inverted Seat - 5/8 - 18 Flare
SBH8024	-3AN Male to 7/16 x 24 Inverted Seat - 5/8 - 18 Flare

Order Jam Nut Separately



### Bulkhead Fittings

Part No.	Description
SBH8015	-3AN Male to 3/8 x 24 Male Bulkhead
SBH8042	-3AN Male to 10mm x 1.0 Male Bulkhead

Order Jam Nut Separately

### Banjos



Part No.	Description
SBH8005	-3AN Male to 10mm (3/8") Straight Banjo Chrome
SBH8009	-3AN Male to 11mm (7/16") Straight Banjo Chrome



SBH8006	-3AN Male to 10mm (3/8") 30° Banjo Chrome
SBH8010	-3AN Male to 11mm (7/16") 30° Banjo Chrome



SBH8007	-3AN Male to 10mm (3/8") 90° Banjo Chrome
SBH8011	-3AN Male to 11mm (7/16") 90° Banjo Chrome



SBH8062	-3AN Male to 10mm (3/8") 90° Banjo (Side Sweep) Chrome
---------	--



SBH8064	-3AN Male to 10mm (3/8") 30° Banjo (Side Sweep) Chrome
---------	--



SBH8008	-3AN Male to 10mm (3/8") Banjo (Short) Zinc
SBH8012	-3AN Male to 11mm (7/16") Banjo (Short) Zinc



SBH5073	-3AN Male to 10mm (3/8") Banjo 15° Square
---------	---

### Fitting Kits

Part No.	Description
BR9000-SAE	Brass Brake Fitting Kit
	• 3/16" Female Inverted Flare Union (10)
	• 1/4" Inverted Flare Union (10)
	• 3/16" Female Inverted Flare x 1/4" Male Inverted Flare (6)
	• 1/4" Female Inverted Flare x 3/16" Male Inverted Flare (6)
	• 1/4" Female Inverted Flare x 9/16-18 male Inverted Flare (2)
	• 3/16" Female Inverted Flare x 1/2-20 Male Inverted Flare (6)
	• 3/16" Female Inverted Flare x 9/16-18 Male Inverted Flare (4)
	• 1/4" Female Inverted Flare x 1/8" Male NPT (2)
	• 3/16" Female Inverted Flare x 1/8" Male NPT (2)



### SS7000-SAE Stainless Steel Brake Tube Nut Kit

• 3/8-24 Male for 3/16" Tube (30)
• 7/16-24 Male for 1/4" Tube (14)
• 9/16-18 Male for 3/16" Tube (10)
• 1/2-20 Male for 3/16" Tube (10)
• 7/16-24 Male for 3/16" Tube (8)
• 9/16-18 Male for 1/4" Tube (8)
• 1/2-20 Male for 1/4" Tube (8)
• 3/8-24 Male Lucas for 3/16" Tube (8)
• 3/8-24 Female for 3/16" Tube (6)



### S.A.E. 37° AN Sizes

Dash sizes are numerators of fractions with a denominator of 16. Example: -6 AN is equal to 6/16" (which equals 3/8")



### N.P.T. Pipe Thread Tapered

1/8" - 27 threads per inch  
1/4" - 18 threads per inch  
3/8" - 18 threads per inch  
1/2" = 14 threads per inch

### Concave Seat

For use with I.S.O. Bubble Flare



### Convex Seat

For use with S.A.E. Double inverted flare



## FITTINGS

### Jam Nuts

Part No.	Description
SBH7007	3/8 - 24 Stainless Steel
SBH8022	3/8 - 24 Zinc
SBH7008	1/2 - 20 Stainless Steel
SBH8056	1/2 - 20 Zinc
SBH7009	5/8 - 18 Stainless Steel
SBH8057	5/8 - 18 Zinc
SBH7011	10mm x 1.0 Stainless Steel
SBH8058	10mm x 1.0 Zinc Jam Nut



### Unions & Adapters

Part No.	Description
SBH8016	-3AN Male to -3AN Male Union

SBH8014	-3AN Male to 3/8 x 24 Inverted Male SAE
SBH8017	-3AN Male to 7/16 x 24 Inverted Male
SBH8018	-3AN Male to 7/16 x 20 Inverted Male

SBH8080	-3AN Male to 1/2 x 20 Inverted Male
---------	-------------------------------------

SBH8081	-3AN Male to 9/16 x 18 Inverted Male
SBH8043	-3AN Male to 1/8 NPT Male Straight

SBH8059	-3AN Male to 1/8 NPT 45° Adp. Male
---------	------------------------------------

SBH8044	-3AN Male to 1/8 NPT 90° Adp. Male
---------	------------------------------------

SBH8060	-3AN Male to 1/8 NPT 90° Adp. Female
---------	--------------------------------------

SBH8079	-3AN Male to -3AN Female 90° Swivel Union
---------	--

SBH8019	-3AN Male to 10mm x 1.0 Male Concave and Convex Seat
---------	---

SBH8078	-3AN Male to 12mm x 1.0 Convex Male Seat
---------	---

SBH8070	-3AN Male to 12mm x 1.0 Concave Seat
---------	---

SBH7012	-3AN Male to -3AN Male x 1/8 NPT Branch Tee Stainless Steel
---------	--

### Rear Axle Blocks

Part No.	Description
SBH5077	-3AN Male to 3/8 x 24 SAE Tee Block with Mounting Hole
SBH5080	-3AN Male to 7/16 x 24 Inverted Ports Brass Tee with Mounting Hole
SBH5078	-3AN Male to 10mm ISO. Flare Tee Block
SBH5079	-3AN Male to 10mm x 1.0 Inverted Ports Tee with Mounting Hole

SBH5082	-3AN Male to 7/16 -20 Male with Ext. Horse Shoe Clip Slot for GM Rear Brake Hose Block
---------	--

### Banjo Bolts

Part No.	Description
SBH8061	3/8 x 24 Single Banjo Bolt Reg - Zinc
SBH7001	3/8 x 24 Single Banjo Bolt - Stainless Steel
SBH8063	7/16 x 24 Single Banjo Bolt Reg - Zinc
SBH7002	7/16 x 24 Single Banjo Bolt Stainless Steel
SBH8065	7/16 x 20 Single Banjo Bolt Reg - Zinc
SBH7003	7/16 x 20 Single Banjo Bolt - Stainless Steel
SBH8067	10 x 1.0mm Single Banjo Bolt Metric - Zinc
SBH7004	10 x 1.0mm Single Banjo Bolt Metric - Stainless Steel
SBH8051	10 x 1.25mm Single Banjo Bolt Metric - Zinc
SBH7005	10 x 1.25mm Single Banjo Bolt Metric - Stainless Steel
SBH8052	10 x 1.5mm Single Banjo Bolt Metric - Zinc
SBH7006	10 x 1.5mm Single Banjo Bolt Metric - Stainless Steel
SBH8097	10 x 1.5mm 25mm Long Metric - Zinc



### Copper Washers

Part No.	Description
SBH8054	10mm (3/8")
SBH8053	11mm (7/16")

### Through Frame Fittings

Part No.	Description
SBH7078	Stainless Through Frame Fittings -3AN Male to 1/8" NPT Female w/JAM Nut - 2-1/2" Frame - Pair
SBH7077	Stainless Through Frame Fittings -3AN Male to 1/8" NPT Female w/JAM Nut - 2"Frame - Pair



## STAINLESS STEEL EXHAUST TUBES

### 304 Stainless Steel 16 Gauge (.065)

*Stainless steel tubes combine excellent physical properties with remarkable resistance to the corrosive agents found in exhaust emissions. 304 stainless steel is the most cost-effective grade of non-magnetic stainless steel for general applications.*

#### Straight Lengths

Straight tubes are sold by the foot, based on the total length of the tube. It is cut to the length you specify. Lengths up to 8 feet can be shipped FedEx.

Part No.	Description	Part No.	Description
65-075	3/4" Diameter	65-238	2-3/8" Diameter
65-100	1" Diameter	65-250	2-1/2" Diameter
65-125	1-1/4" Diameter	65-263	2-5/8" Diameter
65-138	1-3/8" Diameter	65-275	2-3/4" Diameter
65-150	1-1/2" Diameter	65-300	3" Diameter
65-163	1-5/8" Diameter	65-325	3-1/4" Diameter
65-175	1-3/4" Diameter	65-350	3-1/2" Diameter
65-188	1-7/8" Diameter	65-400	4" Diameter
65-200	2" Diameter	65-450	4-1/2" Diameter
65-213	2-1/8" Diameter	65-500	5" Diameter
65-225	2-1/4" Diameter		

#### 180° "J" Bend

Part No.	Description	Part No.	Description
65-18J-175-25	1-3/4" Diameter	2-1/2" Radius	Legs 6" x 12"
65-18J-175-30	1-3/4" Diameter	3" Radius	Legs 6" x 12"
65-18J-188-30	1-7/8" Diameter	3" Radius	Legs 6" x 12"
65-18J-200-30	2" Diameter	3" Radius	Legs 6" x 12"
65-18J-213-30	2-1/8" Diameter	3" Radius	Legs 6" x 12"
65-18J-225-40	2-1/4" Diameter	4" Radius	Legs 6" x 12"
65-18J-250-40	2-1/2" Diameter	4" Radius	Legs 6" x 12"

#### 180° "U" Bend

Part No.	Description	Part No.	Description
65-180-075-20	3/4" Diameter	2" Radius	Legs 6" x 6"
65-180-100-25	1" Diameter	2-1/2" Radius	Legs 6" x 6"
65-180-125-20	1-1/4" Diameter	2" Radius	Legs 6" x 6"
65-180-138-25	1-3/8" Diameter	2-1/2" Radius	Legs 6" x 6"
65-180-150-25	1-1/2" Diameter	2-1/2" Radius	Legs 6" x 6"
65-180-150-40	1-1/2" Diameter	4" Radius	Legs 6" x 6"
65-180-163-25	1-5/8" Diameter	2-1/2" Radius	Legs 6" x 6"
65-180-163-40	1-5/8" Diameter	4" Radius	Legs 6" x 6"
65-180-175-25	1-3/4" Diameter	2-1/2" Radius	Legs 6" x 6"
65-180-175-30	1-3/4" Diameter	3" Radius	Legs 6" x 6"
65-180-175-40	1-3/4" Diameter	4" Radius	Legs 6" x 6"
65-180-188-30	1-7/8" Diameter	3" Radius	Legs 6" x 6"
65-180-188-40	1-7/8" Diameter	4" Radius	Legs 6" x 6"
65-180-188-60	1-7/8" Diameter	6" Radius	Legs 6" x 6"
65-180-200-30	2" Diameter	3" Radius	Legs 6" x 6"
65-180-200-40	2" Diameter	4" Radius	Legs 6" x 6"
65-180-200-60	2" Diameter	6" Radius	Legs 6" x 6"
65-180-213-30	2-1/8" Diameter	3" Radius	Legs 6" x 6"
65-180-213-40	2-1/8" Diameter	4" Radius	Legs 6" x 6"
65-180-213-60	2-1/8" Diameter	6" Radius	Legs 6" x 6"
65-180-225-40	2-1/4" Diameter	4" Radius	Legs 6" x 6"
65-180-250-40	2-1/2" Diameter	4" Radius	Legs 6" x 6"
65-180-275-40	2-3/4" Diameter	4" Radius	Legs 6" x 6"
65-180-300-45	3" Diameter	4-1/2" Radius	Legs 6" x 6"
65-180-350-45	3-1/2" Diameter	4-1/2" Radius	Legs 6" x 6"
65-180-400-60	4" Diameter	6" Radius	Legs 6" x 9"

#### 15° Bend

Part No.	Description	Part No.	Description
65-15-150-25	1-1/2" Diameter	2-1/2" Radius	Legs 3" x 4"
65-15-175-30	1-3/4" Diameter	3" Radius	Legs 3" x 4"
65-15-188-30	1-7/8" Diameter	3" Radius	Legs 4" x 5"
65-15-200-30	2" Diameter	3" Radius	Legs 4" x 5"
65-15-213-30	2-1/8" Diameter	3" Radius	Legs 4" x 5"
65-15-225-40	2-1/4" Diameter	4" Radius	Legs 4" x 5"
65-15-250-40	2-1/2" Diameter	4" Radius	Legs 4" x 5"
65-15-300-40	3" Diameter	4" Radius	Legs 4" x 5"

#### 45° Bend

Part No.	Description	Part No.	Description
65-45-150-25	1-1/2" Diameter	2-1/2" Radius	Legs 6" x 6"
65-45-175-30	1-3/4" Diameter	3" Radius	Legs 6" x 6"
65-45-200-30	2" Diameter	3" Radius	Legs 6" x 6"
65-45-225-40	2-1/4" Diameter	4" Radius	Legs 6" x 6"
65-45-250-40	2-1/2" Diameter	4" Radius	Legs 6" x 6"
65-45-300-40	3" Diameter	4" Radius	Legs 6" x 6"
65-45-350-35	3-1/2" Diameter	3-1/2" Radius	Legs 6" x 6"
65-45-400-40	4" Diameter	4" Radius	Legs 4" x 8"

#### 90° Bend

Part No.	Description	Part No.	Description
65-90-075-20	3/4" Diameter	2" Radius	Legs 4" x 12"
65-90-100-25	1" Diameter	2-1/2" Radius	Legs 4" x 12"
65-90-125-20	1-1/4" Diameter	2" Radius	Legs 4" x 12"
65-90-138-25	1-3/8" Diameter	2-1/2" Radius	Legs 4" x 12"
65-90-150-25	1-1/2" Diameter	2-1/2" Radius	Legs 4" x 12"
65-90-163-25	1-5/8" Diameter	2-1/2" Radius	Legs 4" x 12"
65-90-175-30	1-3/4" Diameter	3" Radius	Legs 4" x 12"
65-90-188-30	1-7/8" Diameter	3" Radius	Legs 4" x 12"
65-90-200-20	2" Diameter	2" Radius	Legs 6" x 6"
65-90-200-30	2" Diameter	3" Radius	Legs 4" x 12"
65-90-213-30	2-1/8" Diameter	3" Radius	Legs 4" x 12"
65-90-225-22	2-1/4" Diameter	2-1/4" Radius	Legs 6" x 6"
65-90-225-40	2-1/4" Diameter	4" Radius	Legs 4" x 12"
65-90-238-30	2-3/8" Diameter	3" Radius	Legs 4" x 12"
65-90-250-25	2-1/2" Diameter	2-1/2" Radius	Legs 6" x 6"
65-90-250-40	2-1/2" Diameter	4" Radius	Legs 4" x 12"
65-90-300-30	3" Diameter	3" Radius	Legs 3" x 6"
65-90-300-40	3" Diameter	4" Radius	Legs 4" x 12"
65-90-350-35	3-1/2" Diameter	3-1/2" Radius	Legs 4" x 8"
65-90-400-40	4" Diameter	4" Radius	Legs 4" x 8"
65-90-450-45	4-1/2" Diameter	4-1/2" Radius	Legs 4" x 8"
65-90-500-52	5" Diameter	5.2" Radius	Legs 6" x 9"

#### For U-bends and J-bends

Determine the Center Line Radius (CLR) by measuring across the outside edges of the bend, subtracting the tubing O.D., and dividing by 2.

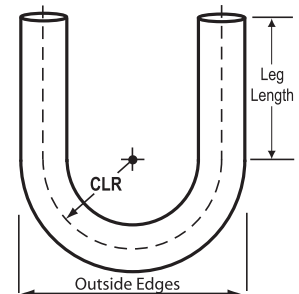

Leg lengths are approximate; usually within +/- .25"

## DISC BRAKE CONVERSION KITS

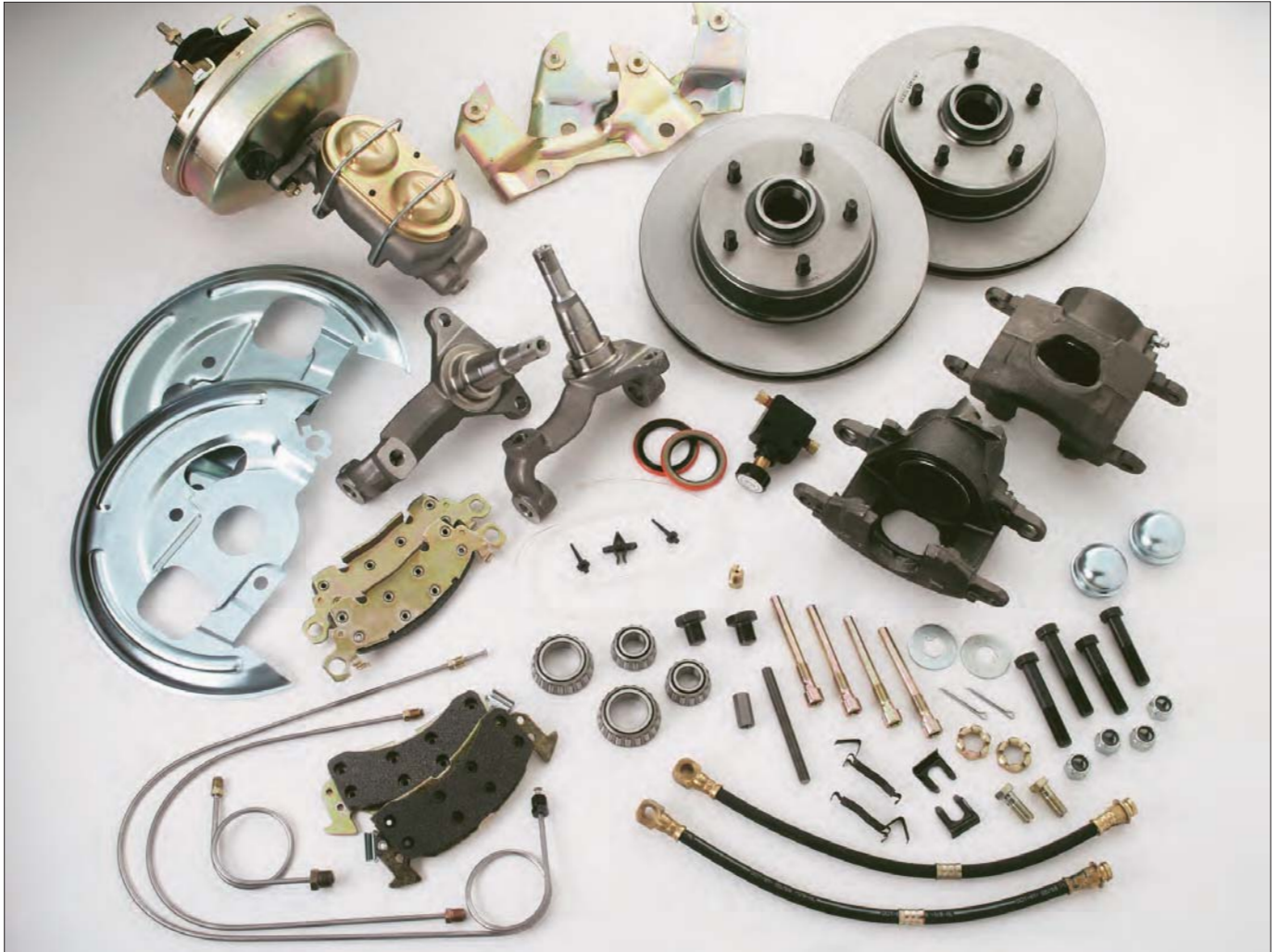

For drum to disc brake conversions with or without an upgrade to larger wheels, Classic Tube offers conversion kits which include all necessary brackets, rotors, calipers, pads, lines, hardware and instructions. All kits bolt on, with no welding or machining required.

We can also custom manufacture complete brake line kits incorporating the aftermarket components of disc brake conversion kits to finish your project correctly.

We can also Build StopFlex® Stainless Steel Braided Hoses – D.O.T. Compliant – for these kits. StopFlex® Hoses offer a much firmer pedal and superior braking efficiency than the alternatives.

***We Have Kits to Upgrade Brakes on These Popular Models and More:***

1967-74 Camaro  
1965-74 Chevelle/ Malibu / El Camino  
1964-72 Cutlass / 442  
1967-74 Firebird  
1965-72 LeMans / GTO / Tempest  
1955-58 BelAir / Impala / 210  
1962-72 Nova / Chevy II  
1965-72 Skylark / GS / A-Body  
1963-72 Fairlane / Falcon V8 / Comet  
1965-72, 1979-93 Mustang / Cougar

Front and/ or Rear Kits are available.

# Featured Products

Prebent Tubing - some of our most popular:  
Mustang, Camaro, Corvette, Jeep, Chevy Truck

**Prebent Brake Line Kits**

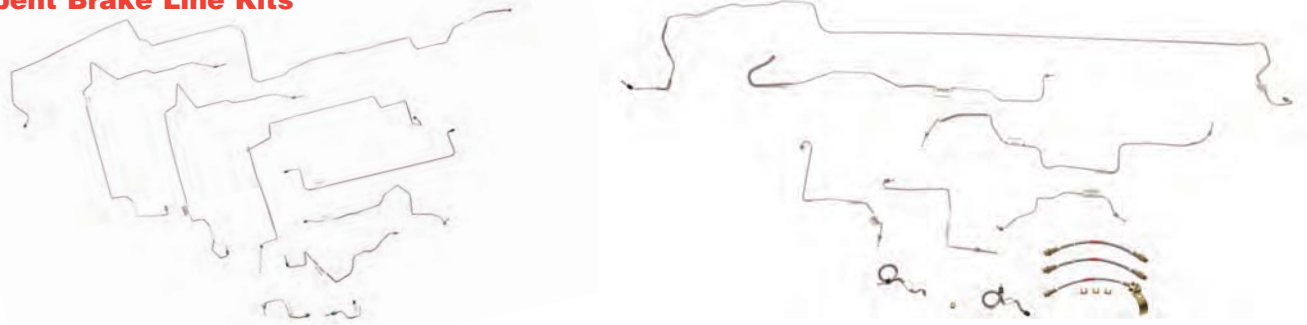

**StopFlex® Stainless Brake Hoses**



**Chevy/GMC Truck Fuel Lines**

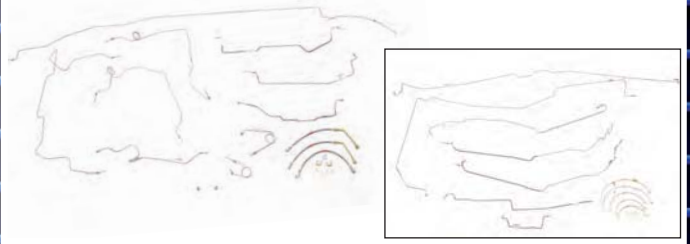

**Bending Tools**



**Universal Flaring Tool Kit**



**Stainless, OE Steel and Aluminum Coils**



**Tubing Straightener**

