

Classic Instruments

Installation Manual

Table of Contents

<i><u>Speedometer Installation</u></i>	1
<i>Speedometer Wiring</i>	1
<i>16-Pulse GM / Chrysler Signal Generator [SN16]</i>	2
<i>Ford Signal Generator Adapter [SN17]</i>	2
<i>3 3/8" Speedometer Wiring to SN16</i>	3
<i>4 5/8" Speedometer Wiring to SN16</i>	4
<i>Calibrating a Speedometer Using a SN16 Signal</i>	5
<i>Speedometer MPH Calibration Chart – SN16 Signal</i>	6
<i>Speedometer KPH Calibration Chart – SN16 Signal</i>	7
<i>Tachometer Installation</i>	8
<i>Tachometer Wiring</i>	8
<i>2 1/8" Gauge Installation</i>	11
<i>2 1/8" Gauge Wiring</i>	11
<i>Quad Cluster Installation</i>	12
<i>4 5/8" Quad Cluster Wiring</i>	12
<i>3 3/8" Quad Cluster Wiring</i>	12
<i>3 3/8" Dual Cluster Installation</i>	14
<i>3 3/8" Dual Temperature & Volt Cluster Wiring</i>	14
<i>3 3/8" Dual Fuel & Oil Pressure Cluster Wiring</i>	14
<i>Oil Pressure Sender Installation</i>	16
<i>Temperature Sender Installation</i>	17
<i>VW Oil Temperature Sensor Kit</i>	18
<i>Oil Pan Temperature Sensor</i>	18
<i>Transmission Temperature Sensor</i>	18
<i>Tachometer Troubleshooting</i>	19
<i>Oil Pressure Troubleshooting</i>	20
<i>Fuel Level Sender/Gauge Troubleshooting</i>	21
<i>Temperature Troubleshooting</i>	22
<i>Battery Volts Troubleshooting</i>	23
<i>Speedometer Troubleshooting</i>	24

Welcome from the Team of Classic Instruments!

Our congratulations and appreciation for your purchase of one of the finest quality sets of specialty instruments ever produced! Your instrument set has been conceived, designed, and manufactured by Classic Instruments, Inc. in the U.S.A. Each instrument has been tested and certified for accuracy and quality before packaging and shipping.

For trouble-free installation and operation follow the instructions exactly as outlined. Your instruments were assembled to precise specifications and although each has a seven (7) year warranty covering defective parts and workmanship – this warranty will not cover instruments or sender units which have been installed incorrectly.

Follow our recommended procedures for installation and proper hookup to maintain the value and appearance of your instrument set during many future years of accurate and dependable service!

LIMITED WARRANTY

Classic Instruments, Inc. (CI) warrants to the original purchaser that any CI product manufactured or supplied by CI will be free from defects in material and workmanship under normal use and service for a period of seven (7) years from date of purchase.

Improper installation, use of sending units other than CI's or attempted repair or adjustments by other than CI shall void this warranty. Disassembly of any instruments or senders for whatever reason shall specifically void this warranty.

It's always easy to look to a part for an issue with your set. Before you conclude that a part may be bad, thoroughly check your work. Today's semiconductors and passive components have reached incredibly high reliability levels, but there is still room for error in our human construction skills. However, on rare occasions a sour part can slip through. Please be aware that testing can usually determine if the part was truly defective or damaged by assembly or usage. Don't be afraid of telling us that you "blew it", we're all human and in most cases, replacement parts are very reasonably priced.

Purchaser agrees and accepts that under no circumstances will a warranty replacement be furnished until CI has first received, inspected, and tested the returned part.

All other warranties expressed or implied are hereby excluded including any implied warranty of merchandise and implied warranty of fitness for a particular purpose. The sole and exclusive remedy for breach of this warranty is limited to the replacement set forth above.

It is expressly agreed that there shall be no further remedy for consequential or other type of damage, including any claim for loss of profit, engine damage or injury.

Speedometer Installation

- 1) Make sure you have sufficient clearance (3 ½") behind the panel where you intend to mount the speedometer.
- 2) If necessary, cut a 3.375" hole or 4.625" hole (depending on which speedometer you have) in the dash panel at the desired location.
- 3) Fit the mounting bracket over the mounting studs of the speedometer. The legs of the bracket may be shortened if required.
- 4) **Don't finalize the mounting until you have performed the calibration of the speedometer!** Leave yourself extra wire in your electrical connections so you are able to remove the gauge from the dash to set the calibration switches on the back.

Speedometer Wiring

- 1) Always disconnect the ground lead from the vehicle battery before wiring any gauge.
- 2) Use a dedicated 5A fuse to provide power to your gauges.
- 3) Connect a switched +12VDC power source to the "B+" or "1" terminal on the back of the speedometer. *We recommend using a dedicated power source for the speedometer to avoid possible problems caused by interference.*
- 4) Connect a good chassis ground to the "GND" or "2" terminal on the back of the speedometer. *We recommend using a dedicated chassis ground (not stacked with other ground wires) to avoid possible problems caused by a bad ground.*
- 5) Connect dash light power to:
 - a. Any one of the black wires from a 3-3/8" speedometer light plug.
 - i. Connect the other black wire to a ground (other than the speedometer ground)
 - b. Terminal "6" on a 4-5/8" speedometer.
- 6) Connect the speed signal to the "SIG" or "3" terminal on the back of the speedometer:
 - a. White wire from a Classic Instruments signal generator (SN16 or SN16F)
 - b. Output from a SN74 speedometer calibration box
- 7) Connect the speed signal ground to the "GND" or "2" terminal on the back of the speedometer:
 - a. Black wire from a Classic Instruments signal generator (SN16 or SN16F)
 - b. Ground of a SN74 speedometer calibration box
- 8) Connect the speed signal power to the "B+" or "1" terminal on the back of the speedometer:
 - a. Red wire from a Classic Instruments signal generator (SN16 or SN16F)
 - b. Power of a SN74 speedometer calibration box

16-Pulse GM / Chrysler Signal Generator [SN16]

Attach the signal generator to the transmission speedometer gear housing (where the speedometer cable originally connected). Do not use excessive force to tighten. These signal generators produce approximately 16,000 pulses per mile (PPM).

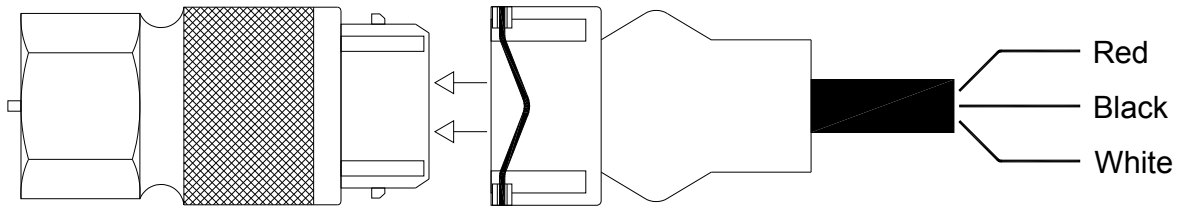

Red: Power (to +12V terminal of speedometer)
Black: Ground (to ground terminal of speedometer)
White: Signal (to signal terminal of speedometer)

Ford Signal Generator Adapter [SN17]

The SN17 adapter allows the SN16 signal generator to be used on a Ford or Tremec transmission with a cable speedometer drive.

Slide a speedometer driven gear onto the end of the adapter and retain with a snap ring (not provided with sender). The number of teeth on the gear does not matter since all Classic Instruments speedometers are able to be calibrated electronically. Make sure the gear spins freely on the adapter (*with SN16 already attached*) before installing into the transmission.

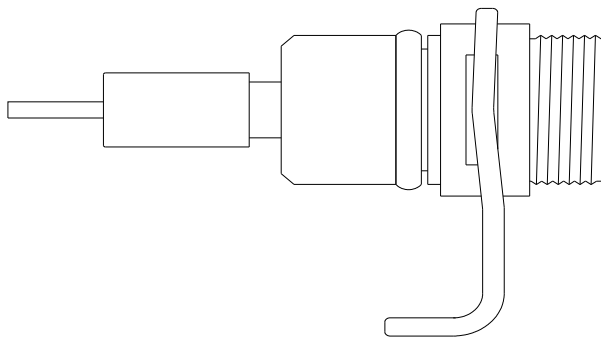

SN17 Transmission Adapter

3 3/8" Speedometer Wiring to SN16

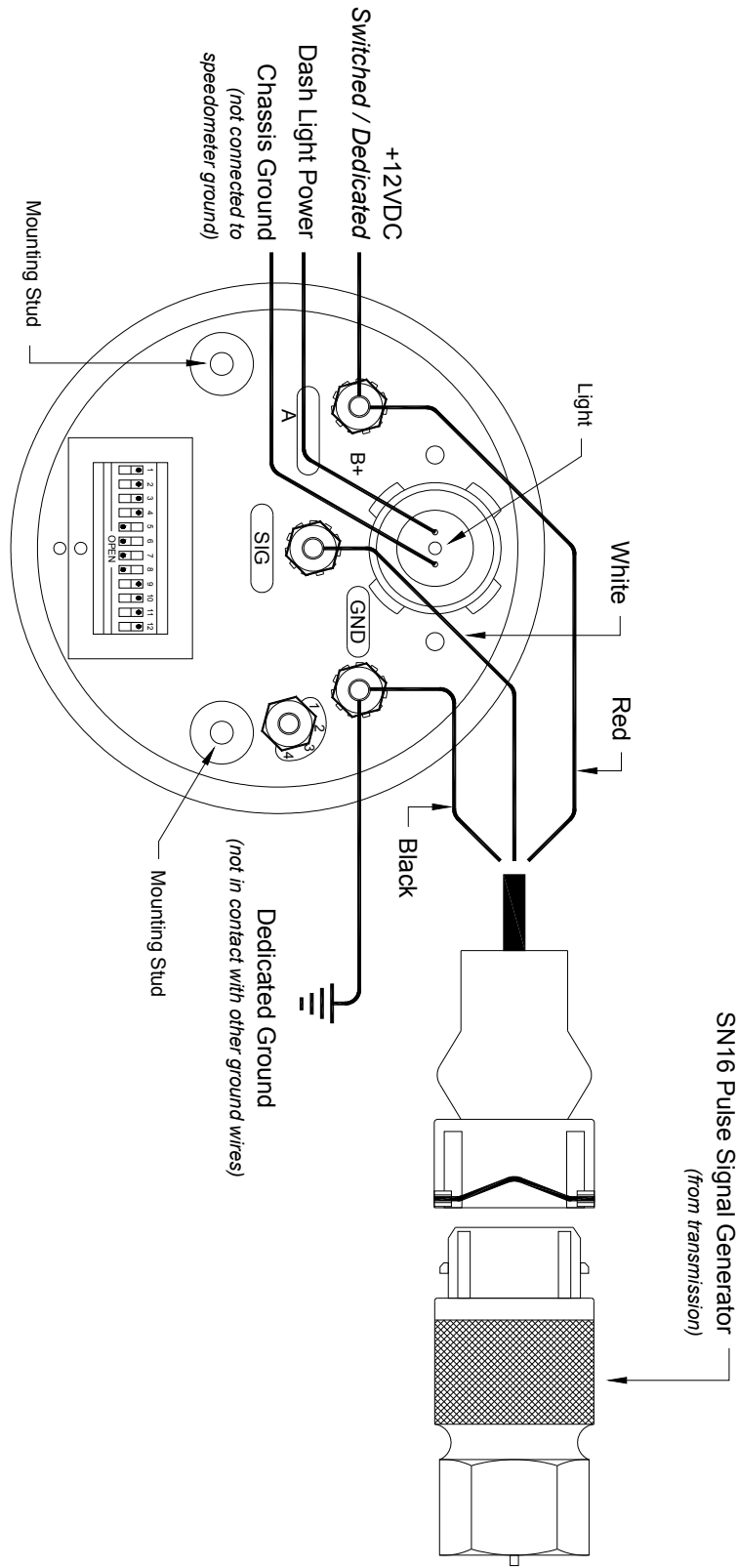

4 5/8" Speedometer Wiring to SN16

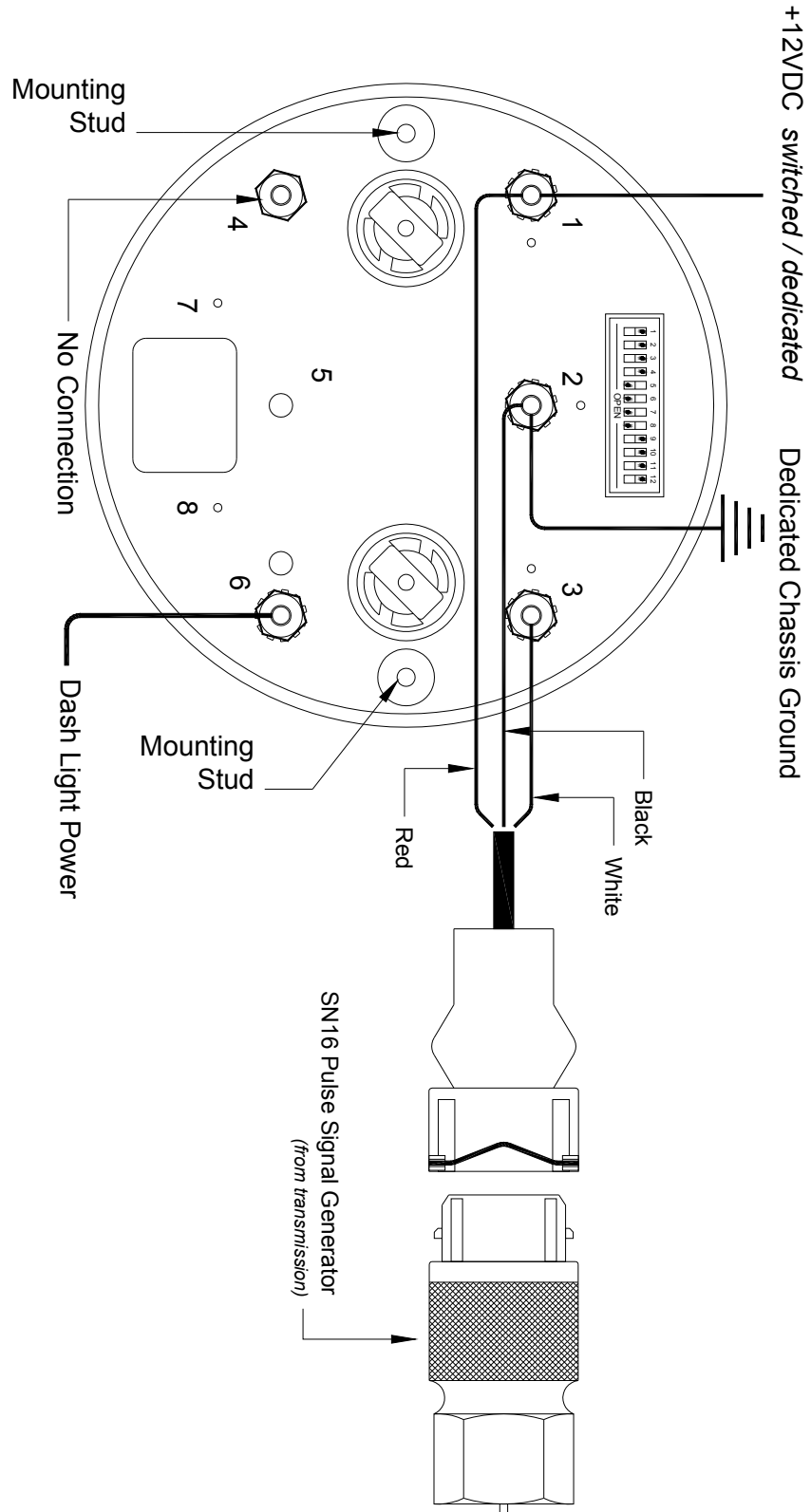

Calibrating a Speedometer Using a SN16 Signal

- 1) Set the 12 dip switches on the back of the speedometer to their default position of (5, 6, 7, 8 *OPEN* for a *MPH* speedometer or 4, 10, 11, 12 *OPEN* for a *KPH* speedometer). **Power to the speedometer must be OFF when making adjustments to the dip switches.**
- 2) Check the current speedometer calibration at a known 60mph (or 100KPH) by pacing a vehicle with a calibrated speedometer or by using a GPS.
- 3) Note the speedometer reading at a known 60mph (or 100KPH).
- 4) Stop the vehicle and turn power OFF to the speedometer.
- 5) Look up the speedometer reading on the 16,000 PPM calibration chart and set the speedometer dip switches according to the chart. The dip switches shown on the chart should be the **ONLY** switches set to OPEN. All other dip switches should be set to CLOSED.
- 6) The speedometer is now calibrated. The dip switches must be set back to the default position in order to use the calibration chart on future calibrations.

Default MPH speedometer dip switch setting:

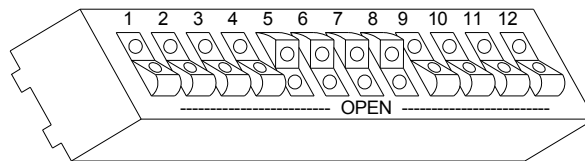

Default KPH speedometer dip switch setting:

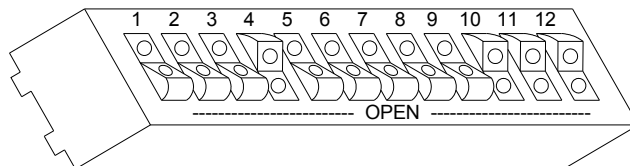

Calibration charts are located on pages 6 & 7

Speedometer MPH Calibration Chart – SN16 Signal

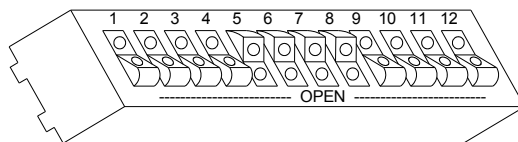

(Default Dip Switch Setting)

(Switch 5 6 7 8 OPEN)

Set speedometer switches **5 6 7 8 OPEN**, all others closed (*code for 16,000 PPM*). Drive vehicle at 60mph. If the speedometer reads other than 60, turn off power & set switches per chart below.

Speedometer Reading	OPEN SWITCH	Speedometer Reading	OPEN SWITCH
40 MPH	8 9 11 12	80 MPH	4 5 6 10 12
41 MPH	7 10 12	81 MPH	4 5 6 8
42 MPH	7 8	82 MPH	4 5 6 8 9 11 12
43 MPH	7 8 9 11 12	83 MPH	4 5 6 7 10
44 MPH	6 10	84 MPH	4 5 6 7 8
45 MPH	6 8	85 MPH	4 5 6 7 8 9 11 12
46 MPH	6 8 9 11 12	86 MPH	3 10 12
47 MPH	6 7 10 12	87 MPH	3 8
48 MPH	6 7 8	88 MPH	3 8 9 11 12
49 MPH	6 7 8 9 11 12	89 MPH	3 7 10 12
50 MPH	5 10	90 MPH	3 7 8
51 MPH	5 8	91 MPH	3 7 8 9 11 12
52 MPH	5 8 9 11 12	92 MPH	3 6 11 12
53 MPH	5 7 10 12	93 MPH	3 6 8
54 MPH	5 7 8	94 MPH	3 6 8 9 11 12
55 MPH	5 7 8 9 11 12	95 MPH	3 6 7 10 12
56 MPH	5 6 10 12	96 MPH	3 6 7 8
57 MPH	5 6 8	97 MPH	3 6 7 8 9 11 12
58 MPH	5 6 8 9 11 12	98 MPH	3 5 10 12
59 MPH	5 6 7 10 12	99 MPH	3 5 8
60 MPH	5 6 7 8	100 MPH	3 5 8 9 11 12
61 MPH	5 6 7 8 9 11 12	101 MPH	3 5 7 10 12
62 MPH	4 10 12	102 MPH	3 5 7 8
63 MPH	4 8	103 MPH	3 5 7 8 9 11 12
64 MPH	4 8 9 11 12	104 MPH	3 5 6 10 12
65 MPH	4 7 10	105 MPH	3 5 6 8
66 MPH	4 7 8	106 MPH	3 5 6 8 9 11 12
67 MPH	4 7 8 9 11 12	107 MPH	3 5 6 7 10 12
68 MPH	4 6 10 12	108 MPH	3 5 6 7 8
69 MPH	4 6 8	109 MPH	3 5 6 7 8 9 11 12
70 MPH	4 6 8 9 11 12	110 MPH	3 4 10 12
71 MPH	4 6 7 10 12	111 MPH	3 4 8
72 MPH	4 6 7 8	112 MPH	3 4 8 9 11 12
73 MPH	4 6 7 8 9 11 12	113 MPH	3 4 7 10 12
74 MPH	4 5 10 12	114 MPH	3 4 7 8
75 MPH	4 5 8	115 MPH	3 4 7 8 9 11 12
76 MPH	4 5 8 9 11 12	116 MPH	3 4 6 10 12
77 MPH	4 5 7 10 12	117 MPH	3 4 6 8
78 MPH	4 5 7 8	118 MPH	3 4 6 8 9 11 12
79 MPH	4 5 7 8 9 11 12	119 MPH	3 4 6 7 10 12

Speedometer KPH Calibration Chart – SN16 Signal

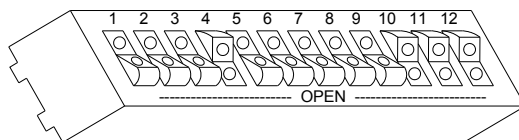

(Default Dip Switch Setting)

(Switch 4 10 11 12 OPEN)

Set speedometer switches **4 10 11 12 OPEN**, all others closed (*code for 16,000 PPM*). Drive vehicle at 100kph. If the speedometer reads other than 100kph, set switches per chart below.

Speedometer Reading	OPEN SWITCH	Speedometer Reading	OPEN SWITCH
62 KPH	9 11 12	142 KPH	3 8 9 10 12
64 KPH	8 9	144 KPH	3 7 9 11
66 KPH	7 10 12	146 KPH	3 7 8 9
68 KPH	7 8 11 12	148 KPH	3 6 10 12
70 KPH	6	150 KPH	3 6 8 11
72 KPH	6 9 10 12	152 KPH	3 6 8 9 10 11 12
74 KPH	6 7 9 10	154 KPH	3 6 7 9 10 12
76 KPH	6 7 9	156 KPH	3 6 7 8 9 11
78 KPH	6 7 8 10 12	158 KPH	3 5 10 11 12
80 KPH	5 11	160 KPH	3 5 8 10
82 KPH	5 9 10 11 12	162 KPH	3 5 7 11
84 KPH	5 8 9 10 12	164 KPH	3 5 7 9 10 11 12
86 KPH	5 7 9 11	166 KPH	3 5 7 8 9 10
88 KPH	5 7 8 10 11 12	168 KPH	3 5 6 9 12
90 KPH	5 6 10 12	170 KPH	3 5 6 8 10 11 12
92 KPH	5 6 8 11	172 KPH	3 5 6 7 10
94 KPH	5 6 8 9 10 11 12	174 KPH	3 5 6 7 8 12
96 KPH	5 6 7 9 10	176 KPH	3 5 6 7 8 9 10 11 12
98 KPH	5 6 7 8 9 11	178 KPH	3 4 9 10
100 KPH	4 10 11 12	180 KPH	3 4 8 9 12
102 KPH	4 8 10	182 KPH	3 4 7 10 11
104 KPH	4 7 12	184 KPH	3 4 7 8 10
106 KPH	4 7 9 10 11 12	186 KPH	3 4 6 12
108 KPH	4 7 8 9 10	188 KPH	3 4 6 9 10 11
110 KPH	4 6 9 12	190 KPH	3 4 6 8 9 11 12
112 KPH	4 6 8 10 11	192 KPH	3 4 6 7 9 12
114 KPH	4 6 7 10	194 KPH	3 4 6 7 8 10 11
116 KPH	4 6 7 8 12	196 KPH	3 4 5 11 12
118 KPH	4 6 7 8 9 10 11	198 KPH	3 4 5 8
120 KPH	4 5 9 11 12	200 KPH	3 4 5 8 9 10 11
122 KPH	4 5 8 9 12	202 KPH	3 4 5 7 9 11 12
124 KPH	4 5 7 10 11	204 KPH	3 4 5 7 8 9
126 KPH	4 5 7 8 11 12	206 KPH	3 4 5 6 10 12
128 KPH	4 5 6	208 KPH	3 4 5 6 8 11 12
130 KPH	4 5 6 9 10 11	210 KPH	3 4 5 6 7
132 KPH	4 5 6 8 9 11 12	212 KPH	3 4 5 6 7 8
134 KPH	4 5 6 7 9	214 KPH	3 4 5 6 7 8 9 11
136 KPH	4 5 6 7 8 10 12	216 KPH	2 9
138 KPH	3 11 12	218 KPH	2 8 10 12
140 KPH	3 8	220 KPH	2 7 11

Tachometer Installation

- 1) Make sure you have sufficient clearance (3 ½") behind the panel where you intend to mount the tachometer.
- 2) If necessary, cut a 3.375" hole or 4.625" hole (depending on which size tachometer you have) in the dash panel at the desired location.
- 3) Fit the mounting bracket over the mounting studs of the tachometer. The legs of the bracket may be shortened if required.
- 4) Set the selector switch or rocker switches on the back of the tachometer for the number of cylinders of the engine. Note: some ignition systems require tachometer settings different than the number of cylinders of the engine.

Tachometer Wiring

- 1) Always disconnect the ground lead from the vehicle battery before wiring any gauge.
- 2) Use a dedicated 5A fuse to provide power to your gauges.
- 3) Connect the "+12V" or "1" terminal on the tachometer to a switched +12VDC power source.
- 4) Connect the "GND" or "2" terminal on the tachometer to a good ground.
- 5) Connect the tachometer signal to terminal "SIG" or "3" on the tachometer. Refer to the list below of ignition system types to help determine where to get the signal.

STANDARD POINTS & CONDENSER SYSTEM

Connect the negative side of the coil (usually marked as "-") to the signal terminal on the tachometer.

GMC – HEI (High Energy Ignition System)

Connect the "TACH" terminal on coil side of distributor cap to the signal terminal on the tachometer.

MSD (Multiple Spark Discharge System)

Connect the Tach signal on the MSD box to the signal terminal of the tachometer. If the tachometer does not respond, your MSD system may require a MSD Tach adapter. Part No. 8910 or 8920.

VERTEX MAGNETO SYSTEM

Connect the "KILL" terminal on the side of a Vertex magneto body to the signal terminal of the tachometer. An external adapter such as an MSD "Pro Mag Tach Converter" #8132 may be required.

ACCEL IGNITION COILS

Connect the negative side of the coil to the signal terminal of the tachometer. CAUTION! Some Accel ignition coils require the tach signal wire to be connected to the "+" terminal on the coil! PLEASE carefully read Accel's instructions before connecting ignition coil.

MALLORY IGNITION

Connect the negative terminal side of coil (usually marked as "-") to the signal terminal of the tachometer.

IMPORTANT! Some Mallory ignition systems may require you to adjust the tachometer at the 4-cylinder setting (rather than the 8-cylinder setting).

ECM TACHOMETER SIGNAL

Signal comes from the computer. When using this type of signal, you may need to set the tachometer to a 4-cylinder setting regardless of the actual cylinders on the engine. Signals below 8V amplitude require the use of either the SN76 tach adapter or a 1K .25W pull-up resistor installed between the signal and power post of the tachometer.

MULTIPLE COIL IGNITION SYSTEMS

A tach adapter is required for these ignition systems. A tach signal driver such as the MSD #8913, which produces a 12V square wave signal, is recommended. Please check with manufacturer for your specific application.

NOTICE! For all other ignition systems please look at the owner's manual for that system.

Tachometer wiring diagrams located on the following page

4 5/8-Inch Tachometer

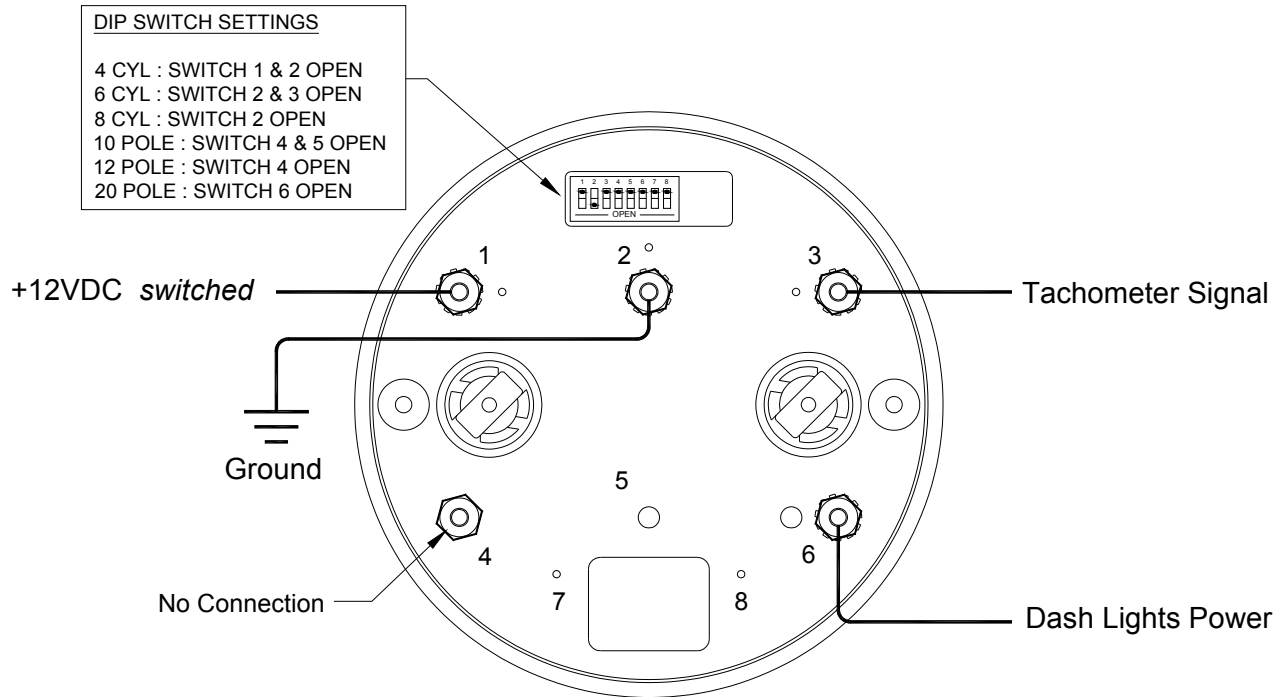

3 3/8-Inch Tachometer

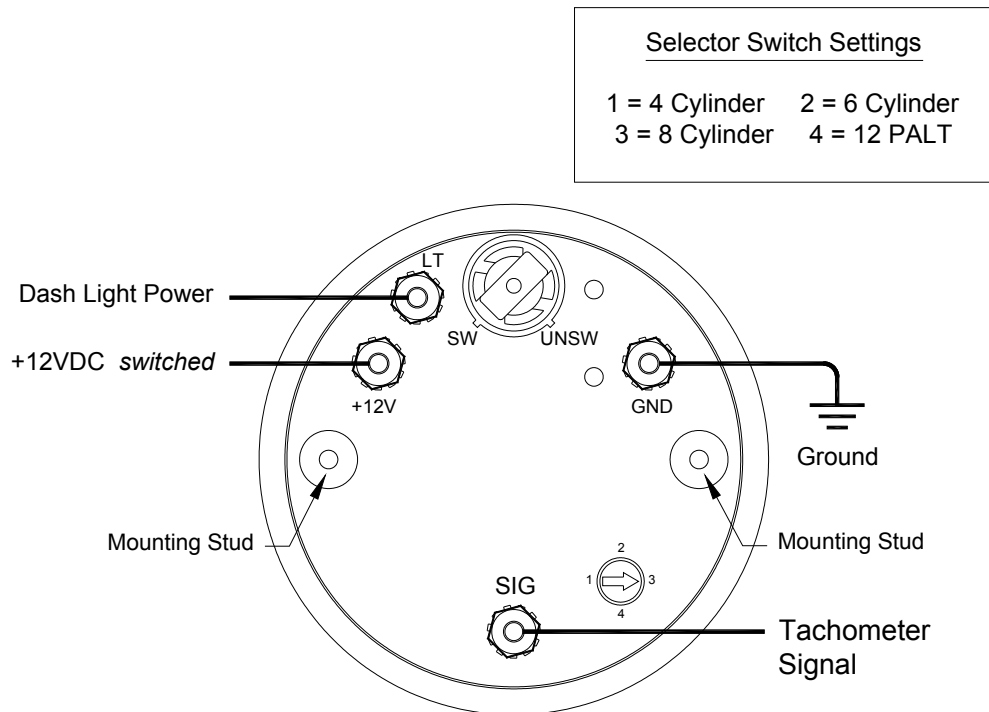

2 1/8" Gauge Installation

- 1) Make sure you have sufficient clearance (2 1/2") behind the panel where you intend to mount the gauge.
- 2) If necessary, cut a 2.125" hole in the dash panel at the desired location.
- 3) Fit the mounting bracket over the mounting studs ("O" and "G") of the gauge. The legs of the bracket may be shortened if required.

2 1/8" Gauge Wiring

- 1) Always disconnect the ground lead from the vehicle battery before wiring any gauge.
- 2) Use a dedicated 5A fuse to provide power to your gauges.
- 3) Connect the sender to terminal "S" on the back of the gauge.
 - a. Volt gauge: no sender is required. **DO NOT connect any wire to the "S" terminal of a volt gauge. The "S" terminal has been intentionally removed on most gauges to help prevent damage.**
 - b. Water Temperature gauge: connect the top terminal of a Classic Instruments temperature sender to the "S" terminal on the back of the gauge.
 - c. Oil Pressure gauge: connect the top terminal of a Classic Instruments oil pressure sender to the "S" terminal on the back of the gauge.
 - d. Fuel gauge: connect the top terminal of a Classic Instruments fuel sender (or signal terminal of an OEM fuel sender if matching gauge was ordered) to the "S" terminal on the back of the gauge.
 - e. Transmission Temperature gauge: connect the top terminal of a Classic Instruments temperature sender to the "S" terminal on the back of the gauge.
 - f. Oil Temperature gauge: connect the top terminal of a Classic Instruments temperature sender to the "S" terminal on the back of the gauge.
- 4) Connect a good ground to terminal "G" on the back of the gauge.
- 5) Connect a switched +12VDC power source to terminal "I" on the back of the gauge.
- 6) Connect dash light power to the spade connector "L" on the back of the gauge.

2 1/8" Fuel, Oil Pressure, Temperature and Volt Gauges

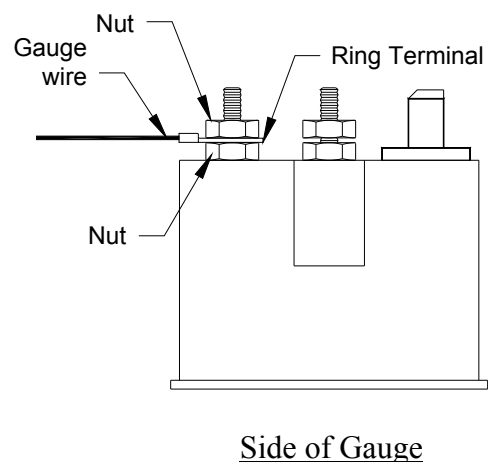
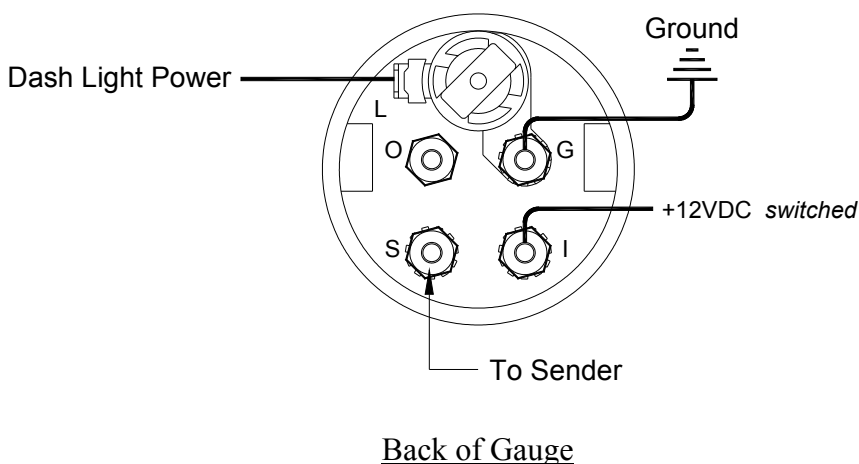

Quad Cluster Installation

- 1) Make sure you have sufficient clearance (3 ½") behind the panel where you intend to mount the quad cluster.
- 2) If necessary, cut a 3.375" hole or 4.625" hole (depending on which size quad cluster you have) in the dash panel at the desired location.
- 3) Fit the mounting bracket over the mounting studs of the quad cluster. The legs of the bracket may be shortened if required.

4 5/8" Quad Cluster Wiring

- 1) Always disconnect the ground lead from the vehicle battery before wiring any gauge.
- 2) Use a dedicated 5A fuse to provide power to your gauges.
- 3) Connect a Classic Instruments fuel level sender (or factory sender if gauge is equipped with matching fuel gauge) to terminal "1" on the back of the quad-cluster.
- 4) Connect a good ground to terminal "2" on the back of the quad-cluster.
- 5) Connect a Classic Instruments water temperature sender to terminal "3" on the back of the quad-cluster.
- 6) Connect a Classic Instruments oil pressure sender to terminal "4" on the back of the quad-cluster.
- 7) Connect dash light power to terminal "7" on the back of the quad-cluster.
- 8) Connect a switched +12VDC power source to terminal "8" on the back of the quad-cluster.

3 3/8" Quad Cluster Wiring

- 1) Always disconnect the ground lead from the vehicle battery before wiring any gauge.
- 2) Connect the Classic Instruments oil pressure sender to terminal "1" on the back of the quad-cluster.
- 3) Connect the Classic Instruments fuel tank sender (or factory sender if gauge is equipped with matching fuel gauge) to terminal "2" on the back of the quad-cluster.
- 4) Connect the Classic Instruments water temperature sender to terminal "8" on the back of the quad-cluster.
- 5) Connect a good ground to terminal "6" on the back of the quad-cluster.
- 6) Connect a switched +12VDC power source to terminal "3" on the back of the quad-cluster.
- 7) Connect dash light power to terminal "7" on the back of the quad-cluster.

Wiring diagrams located on the following page

4 5/8" Quad Cluster

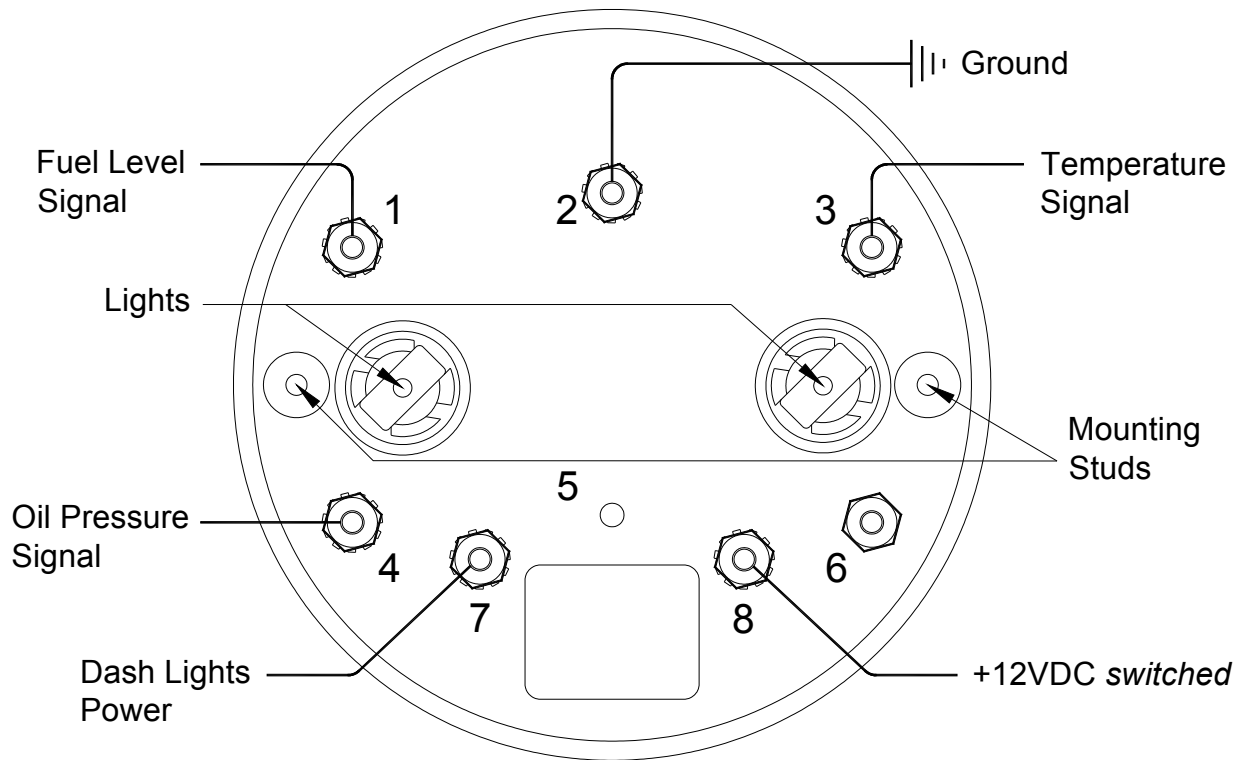

3 3/8" Quad Cluster

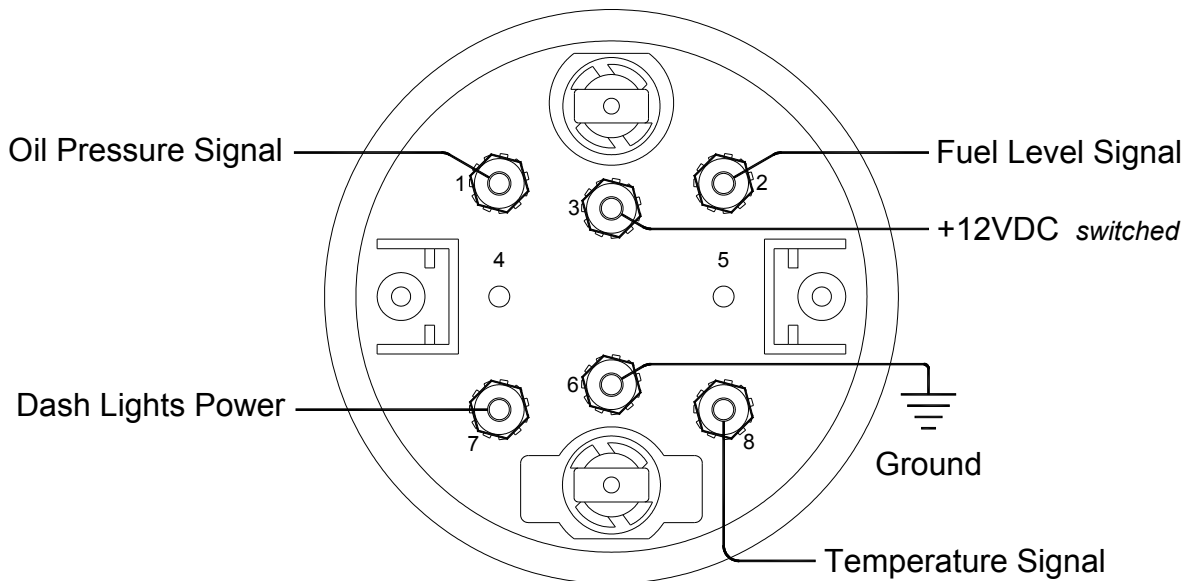

Older 3-3/8" quad gauges have alternate labeling as follows: 3 = B+, 6 = GND, 8 = 3, 7 = 4

3 3/8" Dual Cluster Installation

- 1) Make sure you have sufficient clearance (3 1/2") behind the panel where you intend to mount the quad cluster.
- 2) If necessary, cut a 3.375" hole in the dash panel at the desired location.
- 3) Fit the mounting brackets over the mounting studs of the dual cluster. The legs of the brackets may be shortened if required.

3 3/8" Dual Temperature & Volt Cluster Wiring

- 1) Always disconnect the ground lead from the vehicle battery before wiring any gauge.
- 2) Use a dedicated 5A fuse to provide power to your gauges.
- 3) Connect the Classic Instruments temperature sender to terminal "2" on the back of the dual-cluster.
- 4) Connect a switched +12VDC power source to terminal "3" on the back of the dual-cluster.
- 5) Connect a good ground to terminal "6" on the back of the dual-cluster.
- 6) Connect dash light power to terminal "7" on the back of the dual-cluster.

3 3/8" Dual Fuel & Oil Pressure Cluster Wiring

- 1) Always disconnect the ground lead from the vehicle battery before wiring any gauge.
- 2) Use a dedicated 5A fuse to provide power to your gauges.
- 3) Connect a Classic Instruments fuel level sender to terminal "2" on the back of the dual-cluster.
- 4) Connect a switched +12VDC power source to terminal "3" on the back of the dual-cluster.
- 5) Connect dash light power to terminal "4" on the back of the dual-cluster.
- 6) Connect a good ground to terminal "6" on the back of the dual-cluster.
- 7) Connect a Classic Instruments oil pressure sender to terminal "7" on the back of the dual-cluster.

Wiring diagrams located on the following page

3 3/8" Dual Temperature & Volt Cluster

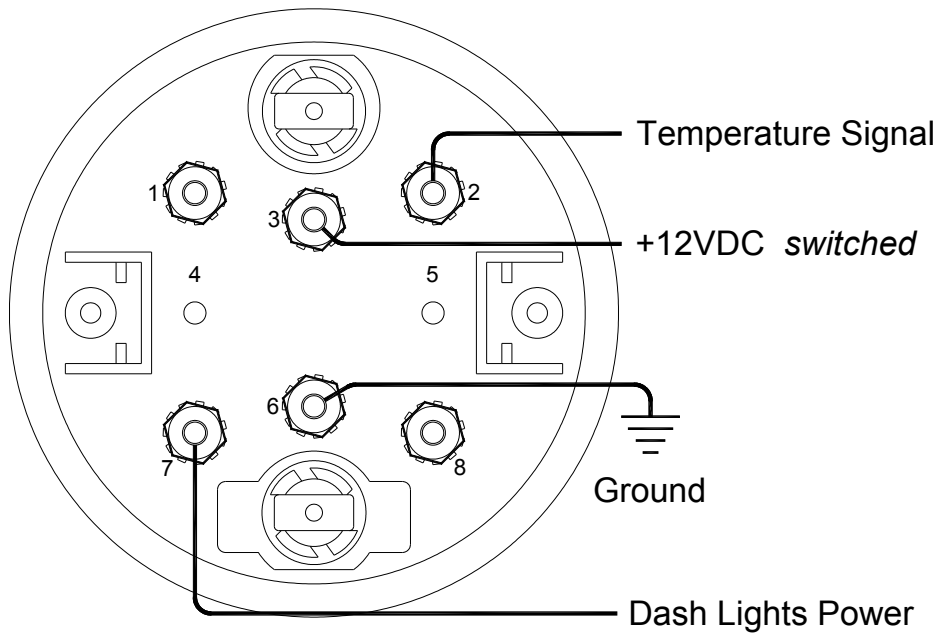

3 3/8" Dual Fuel & Oil Pressure Cluster

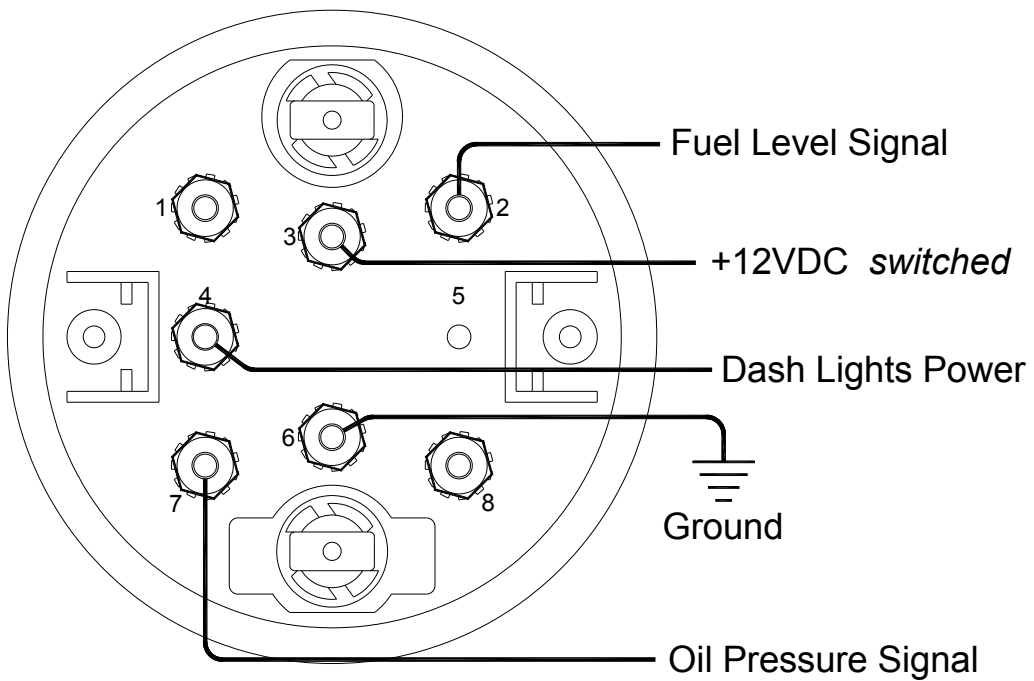

Oil Pressure Sender Installation

(Part No. SN52, SN53 & SN54)

- 1) Disconnect battery before installation.
- 2) Only install Classic Instruments sending units when the engine is COLD.
- 3) DO NOT use Teflon tape on the threads. These threads are slightly tapered and designed to be self-sealing. The sender uses the threads for its ground connection and sealant may cause a poor ground causing inaccurate readings

GM Installation: The correct location on most GM V8-engines to install the oil pressure sender is under the distributor housing at the rear of the block.

Use the 2 piece bushing kit provided to allow the sender to be mounted at a 45-degree angle pointing towards the driver's knees. This allows the sender to clear the back of the intake manifold, the underside of the distributor housing and also the firewall.

GM Installation – Big Block Engines: We do NOT recommend installing Classic Instrument's oil pressure sender in the opening located just above the oil filter on some big block GM engines. This location may not be a full-pressure passage but instead a "by-pass" oil passageway. Installing our pressure sender at this location may result in some strange low-pressure readings under certain driving conditions. This does not indicate a defective instrument or sender! It simply means you need to move the sender to the correct location.

GM Installation – LS Engines: Install the sender in the oil bypass housing located just above the oil filter. The housing will need to be drilled and tapped to 1/8"NPT.



LS1 Oil Bypass Housing

FORD Installation: Install the Classic Instrument's oil pressure sender in the Ford V-8 block using the brass bushing kit (all three pieces) provided. These bushings allow the pressure sender to be installed between the motor mount and stock fuel pump. Ford also manufactures a pressure sender extension and if your engine has one of these in place, our brass bushing kit will not be required.

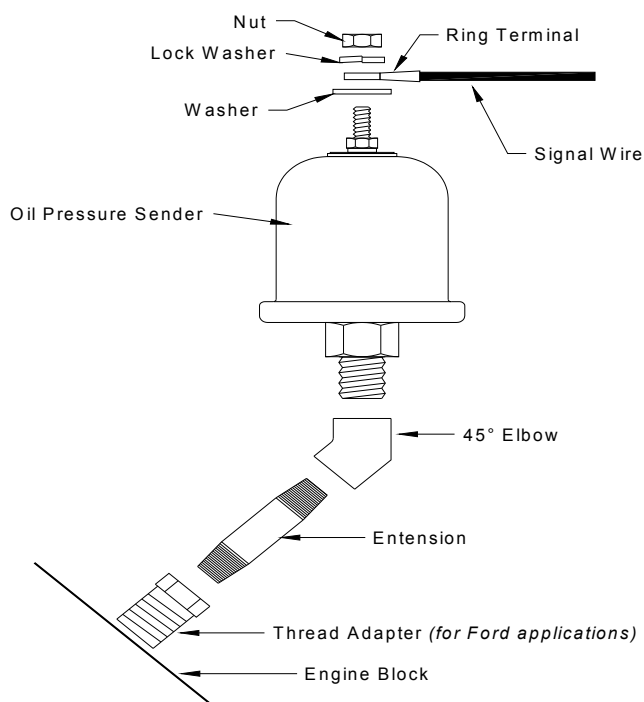

Temperature Sender Installation

(Part No. SN22, SN23, SN24 & SN25)

- 1) Disconnect battery before making any connections.
- 2) Install the Classic Instrument's temperature sending unit only when the engine is COLD!
- 3) DO NOT use Teflon tape on the threads. These threads are slightly tapered and designed to be self-sealing. The sender uses the threads for its ground connection and sealant may cause a poor ground causing inaccurate readings
- 4) Install the temperature sender into the intake manifold of your engine as possible. Installing the sender in the engine cylinder head may cause inaccurate temperature readings.
 - a. On GM "LS" engines, the temperature sender mounts on the passenger side of the engine under the rear cylinder. A 12mm thread sender is available to fit this location.
- 5) Connect a wire from the top terminal of the temperature sender to the indicated signal/sensor post on the back of the temperature gauge.
- 6) Tighten until snug. DO NOT OVER TIGHTEN!

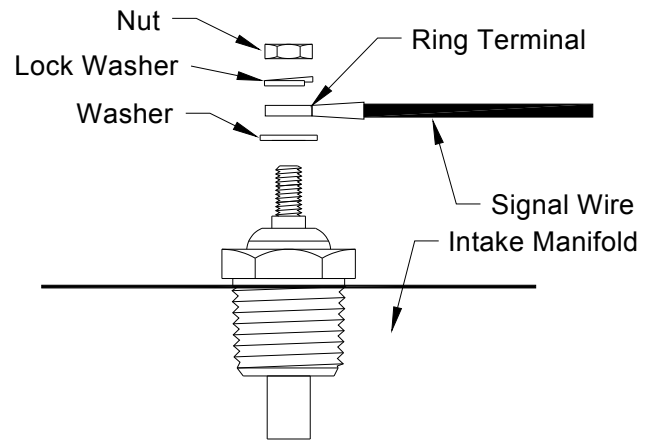

Notice: Avoid installing the temperature sender into the head of a late-model GMC engine. Even though the stock GMC sender may have been installed there, this opening is too close to the exhaust header and will most likely cause an improper reading.

VW Oil Temperature Sensor Kit

VW-type oil temperature sensor kits include sender, metric adapter plug and VW sealing gasket. Install without modification into the oil pressure relief plug opening found on most air-cooled 1960's-type (flat-four air-cooled) VW engines. *Not for installation in the oil-drain plug opening!*

Most VW experts agree the oil pressure relief plug opening in the engine block behind the rear cylinder on the driver's side (U.S. left-hand drive) is a better choice for oil temperature sensor location than installing in the dipstick tube or in the oil pan drain opening.

Oil Pan Temperature Sensor

The temperature of the engine oil in the oil pan can be monitored with our oil temperature sender and gasket. Sender replaces stock drain plug (1/2 – 20 thread) on most GM and Ford engines.

Transmission Temperature Sensor

Classic Instruments recommends monitoring the transmission fluid temperature from the transmission pan. You may need to drill and mount a weld-in bung in your pan to install the temperature sender.

In line transmission temperature manifolds are also available for mounting the temperature sender. However, some transmission companies have stated you may get higher than normal readings if an in-line manifold is used.

Transmission fluid temperature should be kept under 210 degrees. At 230 degrees, the fluid breaks down and the clutches start to glaze resulting in transmission failure.

Tachometer Troubleshooting

Problem: Tachometer pointer seems to be stuck at 1000-1500RPM

Solution: Check +12VDC and GROUND to gauge. Pointer “floats” when no power is supplied to gauge.

Problem: Tachometer showing lower or higher RPM than actual.

Solution: Check cylinder selector on back of tachometer. Tachometer is set at 8-cylinder setting from factory. Computer tachometer signals sometimes need the gauge to be set on a 4-cylinder setting.

Gauge packages that incorporate a black control box (Speedtacular) require a signal doubler (SN76) when using some computer signals.

Problem: Tachometer pointer reads at idle but will not indicate higher RPM even when engine revved.

Solution: If you are using a MSD ignition system you may need to use an adapter (8910 or 8920). See MSD for the model that is right for your ignition.

Problem: Tachometer pointer falls even when maintaining steady engine RPM using a points ignition system.

Solution: Install new points. Check distributor shaft and bearings for wear or play.

Problem: Tachometer pointer stays at 0 even when engine is running.

Solution: Check signal wire for continuity. Insure that you are using correct signal (negative side of coil for points ignitions, “tach” post on MSD box, “tach” post on HEI distributor, correct signal wire from computer, etc...)

Try using your speed signal with the tachometer (if you know your speedometer is working) to insure the unit will work when given a known good signal.

Oil Pressure Troubleshooting

Problem: **Pointer pegs past 100PSI every time power is applied to gauge.**

Solution: Make sure sending wire is not being grounded. Removing the sender wire from the gauge should make the pointer move back to 0PSI.

Check the gauge ground. A bad ground will cause the pointer to read high.

Problem: **Pointer doesn't show above 0PSI, even when the engine is producing pressure.**

Solution: Check continuity on your sender wire. Insure that you have not used Teflon tape on sender. (The pressure sender requires a ground from the engine and Teflon inhibits a good ground.)

Grounding the sender wire should make the gauge read above 100PSI.

Problem: **Gauge reads lower than actual pressure.**

Solution: Insure that no Teflon tape was used on the pressure sender. A bad sender ground will cause low or no pressure readings on the gauge.

Gauge scale is not linear from 0-25PSI and 75-100PSI. Halfway between 0 and 25PSI is actually 20 PSI, not 12.5PSI if the reading were linear.

Problem: **Gauge reads extremely high when engine is idling or not running and drops when engine is revved.**

Solution: You may be using an incorrect oil pressure sender. Make sure to use a Classic Instruments oil pressure sender that is a match for the gauge. Stock GM oil pressure senders will cause a Classic Instruments gauge to read backwards.

Fuel Level Sender/Gauge Troubleshooting

(SN35, SN36, SN38 & SN39)

Identify your fuel gauge: *Refer to sticker on side of gauge.*

Ohm Range	OEM Sender	Gauge Labeled
0-30 ohm	GM 1964 & earlier	Yes
0-90 ohm	GM 1966 & later	Yes
75-10 ohm	Ford 1986 & earlier	Yes
16-158 ohm	Ford 1987 & later	Yes
240-33 ohm	Universal Sender (SN35)	No

Problem: **Fuel gauge reads “Full” when powered and the tank is not actually full.**

Solution: *240-33 ohm and 75-10 ohm gauges* → insure sending wire is not being grounded. (Removing sending wire from gauge should cause pointer to peg past Empty) Try a temporary wire from sender to gauge. Ensure that the fuel sender has a good ground.

All other ohm gauges → Check continuity on sending wire. Check if sending wire is attached to correct stud on gauge. (Grounding sending wire on gauge should cause pointer to peg past Empty) Try a temporary wire from sender to gauge.

Problem: **Fuel gauge reads “Empty” no matter how much fuel is in tank.**

Solution: *240-33 ohm and 75-10 ohm gauges* → Check continuity on sending wire. Check if sending wire is attached to correct stud on gauge. (Grounding the sender post on the gauge should cause pointer to peg past Full)

All other ohm gauges → insure sending wire is not being grounded. (Removing sending wire from gauge should cause the pointer to peg past Full) Insure that the fuel sender has a good ground.

Problem: **Pointer shows increasing fuel level when fuel level is actually decreasing.**

Solution: Fuel gauge doesn't match the fuel sender in tank.
Fuel sender rheostat may be mounted upside down in the tank.

Problem: **Pointer stuck somewhere above empty and below full.**

Solution: Fuel sender float arm may be obstructed. Try removing fuel sender and manually moving the float arm.

Check power and ground to gauge. Pointer may not return to empty when power is removed on all fuel gauges.

Temperature Troubleshooting

Problem: Pointer pegs past “Hot” when power is applied to gauge.

Solution: Insure that the sender wire is not being grounded. Removing the sending wire from the gauge should cause the pointer to read below “Cold”

Check the ground to the gauge. A bad or no ground on the gauge will cause the pointer to peg to “Hot”.

Problem: Pointer does not move above “Cold”.

Solution: Check continuity on the sender wire. Grounding the sending post on the gauge should make the pointer peg past “Hot”.

Insure that no Teflon tape was used on the sender. The sender requires a ground from the engine and Teflon tape creates a bad ground. Try running a ground wire to the base of the temperature sender and see if the gauge starts reading correctly.

Problem: Gauge reading hotter than actual engine temperature.

Solution: Insure there is no heat source near the sender (i.e. exhaust) NOTE: Coolant temperature inside the engine will be 15-20 degrees higher than temperatures on the outside of the engine read by laser gauges.

Problem: Temperature stays constant somewhere above cold and below hot no matter what the heat of the engine.

Solution: Check power and ground to gauge. Pointer does not always return to cold after power is removed on some models.

Problem: Gauge reads normal until engine warms up, and then continues to climb past normal reading and coolant isn't boiling.

Solution: Insure sender is mounted in correct location. Sender should not be installed on the side of a GMC block, even if original was installed there.

Problem: Gauge reads low.

Solution: The temperature gauge reads colder as the resistance to ground of the sender increases. Teflon tape on the threads of the sender could cause the gauge to read more resistance to ground and therefore read colder than the actual temperature. Make sure you don't have any Teflon tape or sealant on the threads of the sender.

LT1 engines have multiple locations where temperature senders can be mounted. Due to the way the coolant flows through the engine, if you install the sender between the 3 and 5 cylinders your gauge will read 60-80 degrees cold. It is recommended to install the sender either on the head between cylinders 2 and 4 or in the side of the water pump housing.

These symptoms are common in many coolant systems and many result from problems other than outlined above. The following should be checked carefully when at any time an abnormal heating or cooling situation occurs.

1. Slipping belt or incorrect pulley.
2. Incorrect thermostat for system.
3. Distributor spark advanced too far.
4. Wrong coolant/anti-freeze mix.
5. Cross-inductance in wiring harness.
6. High volume water pump installed when not required by total system.
7. Thermostat removed to increase coolant flow, reduced overheating!
8. Insufficient radiator capacity for size of engine and horsepower.
9. Intake manifold has been painted, polished, chrome plated
10. Sender installed too deep and sensor tip is touching other side of passageway.
11. Sender not threaded far enough into manifold; too many threads exposed to allow good “heat-sink” effect from sender.

Our temperature senders will always read the hotter of two adjacent temperatures. Therefore if your sender is installed in a hot spot on the engine such as next to the exhaust pipes on the side of the engine block, the gauge may read as high as 250°F but your radiator seems only mildly warm.

The temperature sender is simply reading the average of two temperatures. For example, your coolant temp is 185°F and your exhaust header temp is 450°F-500°F. The temp sender can only try to read the average of these two temperatures. Therefore your temp reading will appear very high, so please keep the temp sender away from any exhaust manifold/header.

Battery Volts Troubleshooting

Problem: Pointer pegs past 18 volts when key is turned on.

Solution: Make sure the ground wire is on the correct post on the gauge. Insure nothing is touching the sender post.

Problem: Pointer pegs below 8 volts when key is turned on.

Solution: Make sure ground and +12VDC wires are on correct studs.

Speedometer Troubleshooting

Identify your speed signal & speedometer type

Signal Source	Signal Interface	Speedometer Type	Troubleshooting Section
Pulse Generator (2-Wire)	NOT NEEDED	8-Pulse (8 switch)	1
Pulse Generator (3-Wire)	NOT NEEDED	16-Pulse (12 switch)	2
VSS signal (electronic trans.)	SN74	8-Pulse (8 switch)	3
VSS signal (electronic trans.)	SN74	16-Pulse (12 switch)	4
ECM signal	SN74	8-Pulse (8 switch)	5
ECM signal	SN74	16-Pulse (12 switch)	6

SECTION 1

Problem: **Speedometer not working at all.**

Solution: Check the dedicated +12VDC (from “ACC” side of ignition switch) and dedicated ground (no other ground wires touching). Check the voltage at speedometer with and without the engine running and insure that voltage is above 11 volts.

Remove pulse generator from transmission. Connect the end to a drill. Apply power to the speedometer. Spin the pulse generator (in either direction)

- If speedometer now works, try same test again with engine running.
 - If speedometer works with engine running, check speedometer gear in transmission.
 - If speedometer doesn't work with engine running, call tech support for noise filtering methods/techniques.
- If speedometer doesn't work, attach a multimeter to both wires of pulse generator and spin with drill. Set meter to read AC voltage.
 - Voltage should increase as speed of drill increases. Typically voltage should be above 5 volts AC with drill running full speed.
 - If no voltage is read, call tech support.

Problem: **Speedometer is way too slow or too fast.**

Solution: Set speedometer dip switches to default (2 6 7 8 OPEN). Toggle each switch to insure it is pressed in all the way.

SECTION 2

Problem: **Speedometer not working at all.**

Solution: Check the dedicated +12VDC (from “acc” side of ignition switch) and dedicated ground (no other ground wires touching). Check the voltage at speedometer with and without the engine running and insure that voltage is above 11 volts.

Remove pulse generator from transmission. Connect the end to a drill. Apply power to the speedometer. Spin the pulse generator (in either direction)

- If speedometer now works, try same test again with engine running.
 - If speedometer works with engine running, check speedometer gear in transmission.
 - If speedometer doesn't work with engine running, call tech support for noise filtering methods/techniques.
- If speedometer doesn't work, attach a multimeter to between the black and white wires of pulse generator and rotate pulse generator tang slowly with fingers. Set meter to read DC voltage.
 - Voltage should alternate between battery voltage and 0. If voltage is always 0 or doesn't alternate, call tech support.

Problem: **Speedometer pointer is erratic.**

Solution: Verify the speedometer is connected to a dedicated ground (not touching any other ground wires) and has a dedicated 12 VDC power source (from “acc” side of ignition switch).

Twist black and white wires of pulse generator together. Route wires away from high power sources and tachometer signal wire.

Call tech support for noise filtering methods/techniques.

Problem: **Speedometer pointer is stuck on wrong side of pointer stop.**

Solution: Attach pulse generator to drill. CLOSE all dip switches on speedometer. Spin generator with drill until pointer moves counter clockwise, and then stop drill. (A high speed drill is required to spin the generator at a 140mph speed equivalent.)

SECTION 3

Problem: **Speedometer not working at all.**

Solution: Check the dedicated +12VDC (from “acc” side of ignition switch) and dedicated ground (no other ground wires touching). Check the voltage at speedometer with and without the engine running and insure that voltage is above 11 volts.

Check power and ground to SN74 interface box. A green light will be lit when interface box has power.

The green light on the SN74 will blink slowly when it detects a signal. If the light is solid and the car is moving, there is a problem with your signal.

Check to insure you are using proper SN74 setup.

Problem: **Speedometer pointer is erratic.**

Solution: Verify the speedometer is connected to a dedicated ground (not touching any other ground wires) and has a dedicated 12 VDC power source (from “acc” side of ignition switch).

Insure the signal wires from the transmission go directly to the SN74. One wire attaches to “sig. ground” and the other to “input”.

Route signal wires away from high voltage sources and tachometer signal wire.

Try setting SN74 sensitivity to LOW (switch #2 ON).

Problem: **Speedometer is way too slow or too fast.**

Solution: Set speedometer dip switches to default (2 6 7 8 OPEN). Toggle each switch to insure it is pressed in all the way.

Insure you have the SN74 set up correctly. Most Ford VSS signals do not require the use of an interface box.

SECTION 4

Problem: **Speedometer not working at all.**

Solution: Check the dedicated +12VDC (from “acc” side of ignition switch) and dedicated ground (no other ground wires touching). Check the voltage at speedometer with and without the engine running and insure that voltage is above 11 volts.

Check power and ground to SN74 interface box. A green light will be lit when interface box has power.

The green light on the SN74 will blink slowly when it detects a signal. If the light is solid and the car is moving, there is a problem with your signal.

Check to insure you are using proper SN74 setup.

Problem: **Speedometer pointer is erratic.**

Solution: Verify the speedometer is connected to a dedicated ground (not touching any other ground wires) and has a dedicated 12 VDC power source (from “acc” side of ignition switch).

Try setting dip switch 2 ON. This sets the SN74 into a lower sensitivity mode and may filter signal interference.

Insure the signal wires from the transmission go directly to the SN74. One wire attaches to “sig. ground” and the other to “input”.

Route signal wires away from high voltage sources and tachometer signal wire.

Call tech support for noise filtering methods/techniques.

Problem: **Speedometer is way too slow or too fast.**

Solution: Make sure your speedometer is set up for the default calibration. (dip switches 5, 6, 7 8 OPEN)

Insure you have the SN74 set up correctly.

Problem: **Speedometer pointer is stuck on wrong side of pointer stop.**

Solution: Set all switches on back of speedometer to the CLOSED position. Drive car until pointer moves counterclockwise (away from the pointer stop). This process usually requires you to travel 40 – 50 mph. Slow down and stop the car and the pointer should return to the correct position. Return the dip switches to their original calibration positions.

SECTION 5

Problem: **Speedometer not working at all.**

Solution: Check the dedicated +12VDC (from “acc” side of ignition switch) and dedicated ground (no other ground wires touching). Check the voltage at speedometer with and without the engine running and insure that voltage is above 11 volts.

Check power and ground to SN74 interface box. A green light will be lit when interface box has power.

The green light on the SN74 will blink slowly when it detects a signal. If the light is solid and the car is moving, there is a problem with your signal.

Check to insure you are using the proper SN74 setup.

Problem: **Speedometer pointer is erratic.**

Solution: Verify the speedometer is connected to a dedicated ground (not touching any other ground wires) and has a dedicated 12 VDC power source (from “acc” side of ignition switch).

Route the signal wire from the computer away from high voltage sources and tachometer signal wire.

Call tech support for noise filtering methods/techniques.

Problem: **Speedometer is way too slow or too fast.**

Solution: Set speedometer dip switches to default (2 6 7 8 OPEN). Toggle each switch to insure it is pressed in all the way.

Insure you have the SN74 set up correctly.

SECTION 6

Problem: **Speedometer not working at all.**

Solution: Check the dedicated +12VDC (from “acc” side of ignition switch) and dedicated ground (no other ground wires touching). Check the voltage at speedometer with and without the engine running and insure that voltage is above 11 volts.

Check power and ground to SN74 interface box. A green light will be lit when interface box has power.

The green light on the SN74 will blink slowly when it detects a signal. If the light is solid and the car is moving, there is a problem with your signal.

Check to insure you are using the proper SN74 setup.

Problem: **Speedometer pointer is erratic.**

Solution: Verify the speedometer is connected to a dedicated ground (not touching any other ground wires) and has a dedicated 12 VDC power source (from “acc” side of ignition switch).

Try setting dip switch 2 ON. This sets the SN74 into a lower sensitivity mode and may filter signal interference.

Route the signal wire from computer away from high voltage sources and tachometer signal wire.

Call tech support for noise filtering methods/techniques.

Problem: **Speedometer is way too slow or too fast.**

Solution: Make sure your speedometer is set up for the default calibration. (switch 5, 6, 7, 8 OPEN)
Insure you have the SN74 set up correctly. (Typically switch 1 2 ON)

Problem: **Speedometer pointer is stuck on wrong side of pointer stop.**

Solution: Set all switches on back of speedometer to the CLOSED position.

Drive car until pointer moves counterclockwise (away from the pointer stop). This process usually requires you to travel 40 – 50 mph. Slow down and stop the car and the pointer should return to the correct position. Return the dip switches to their original calibration positions.