

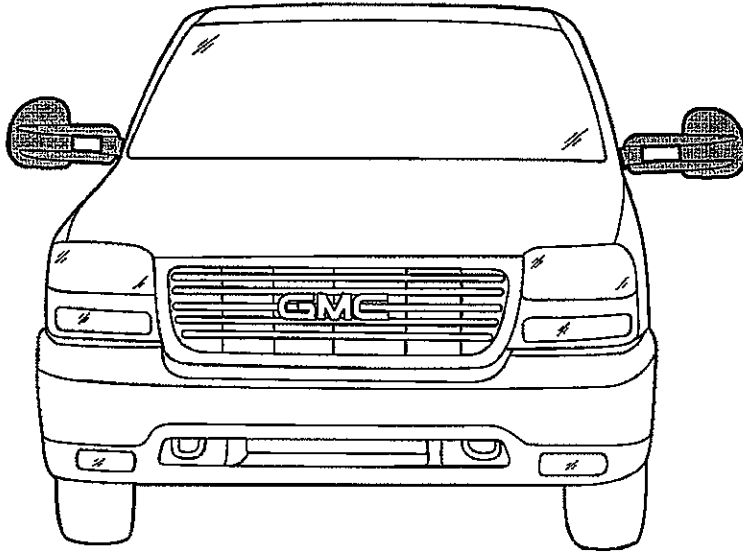

Extendable Replacement Mirror Installation Instructions

For CIPA Part #'s 70200, 70700



* Chevrolet	Years
Silverado	2003-2005
Suburban	2003-2005
Tahoe	2003-2005
GMC	Years
Sierra	2003-2005
Yukon	2003-2005
Yukon XI	2003-2005

WARNING

Manufacturer recommends this installation be carried out by a professional installer or your local Chrysler Dealer. PLEASE read ALL INSTRUCTIONS and warnings carefully before installing this product. These mirrors are designed only for the vehicles listed on this page. Ensure that the fitting instructions are followed exactly, as failure to do so MAY result in incorrect installation, result in the driver, passenger or vehicle being placed in a hazardous condition, damage to the vehicle as well as voiding of any warranty, implied or otherwise.

PARTS LIST

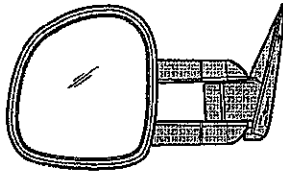

Driver's Side Mirror

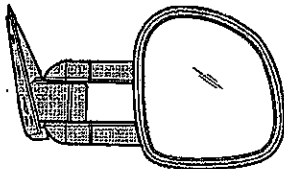

Passenger Side Mirror



10mm Nut

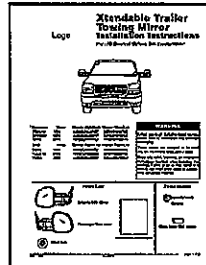

Installation Instructions

TOOLS NEEDED

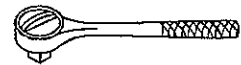

Ratchet

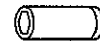

10mm Deep Well Socket

1 - 8

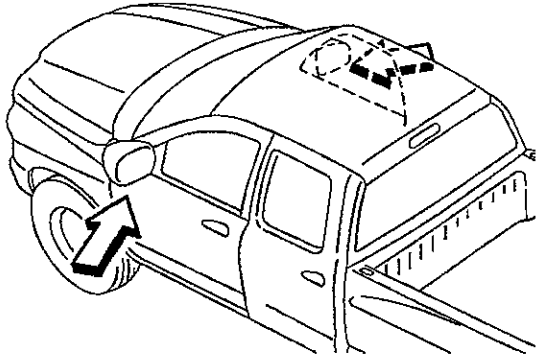

1

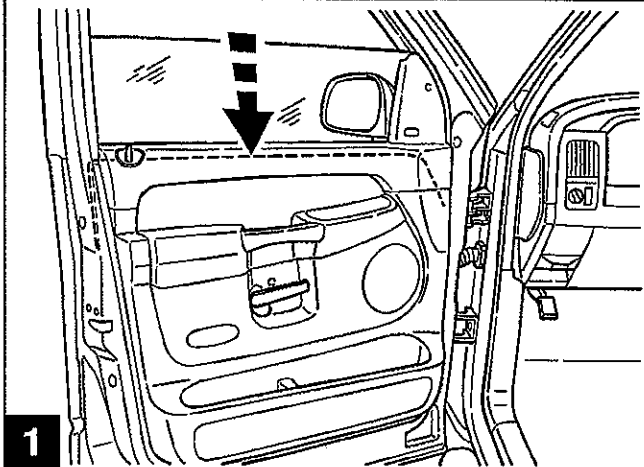

RE-TIGHTEN TO:
85in.-lbs.
(9.6 N·m)

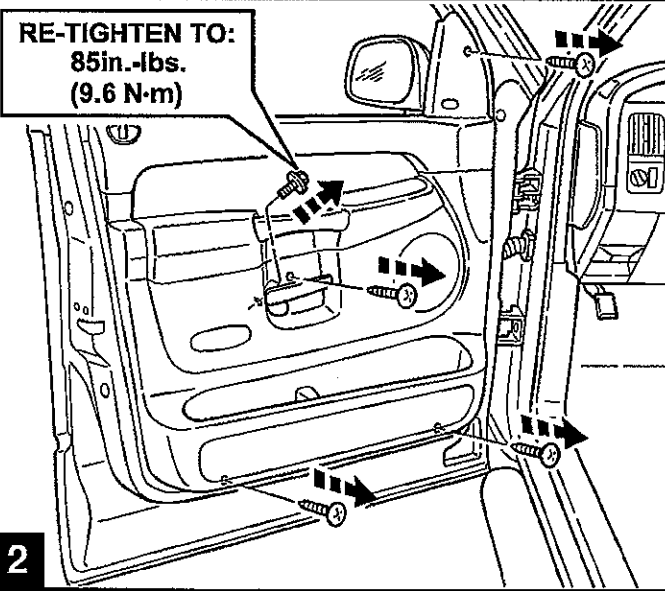

2

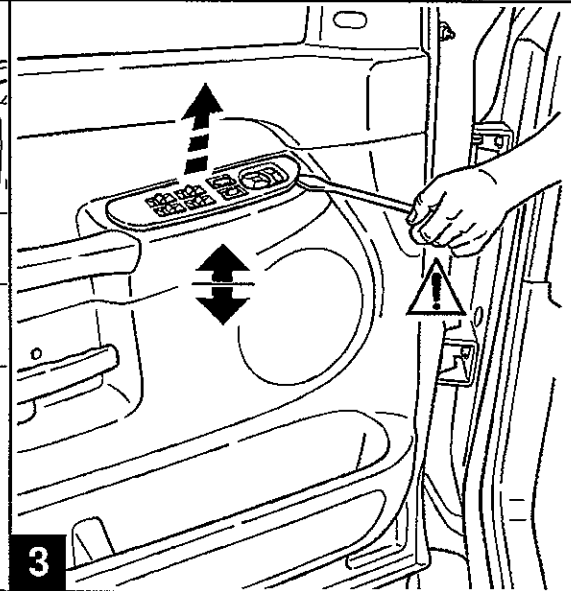

3

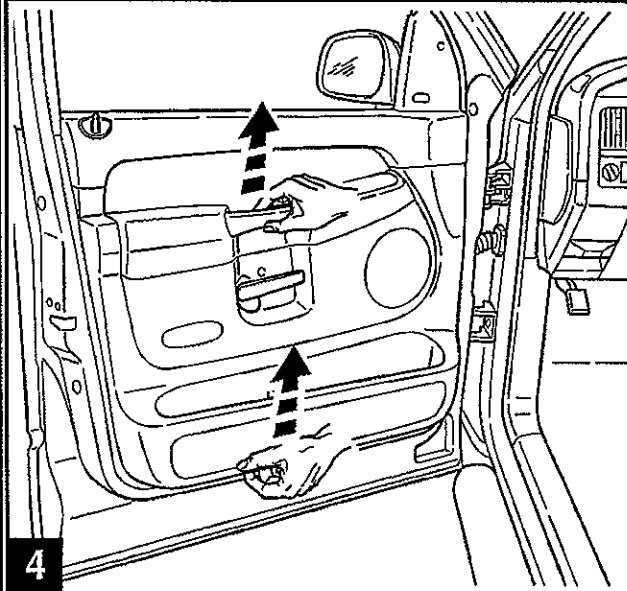

4

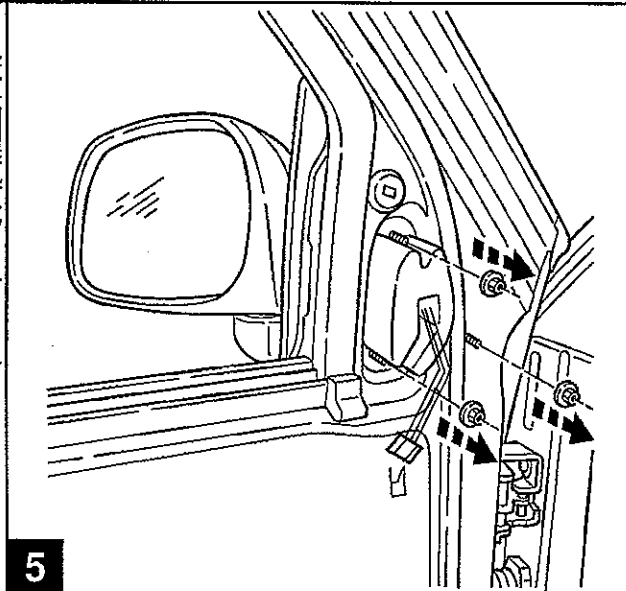

5

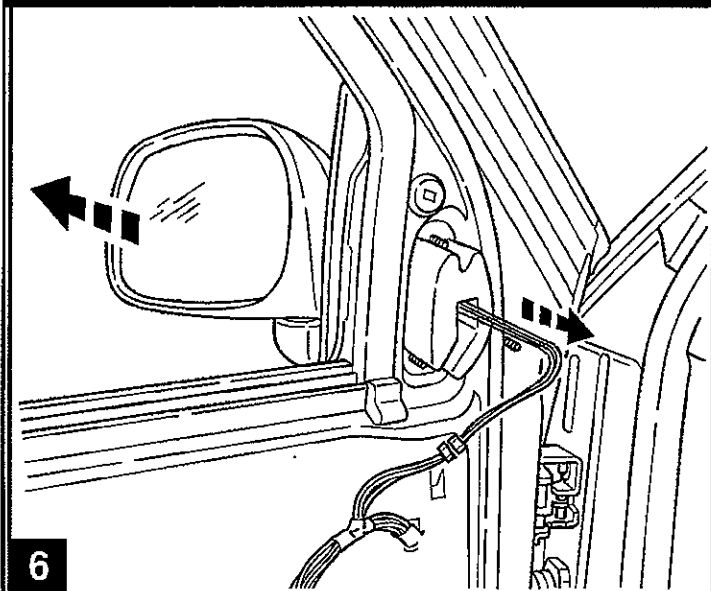

6

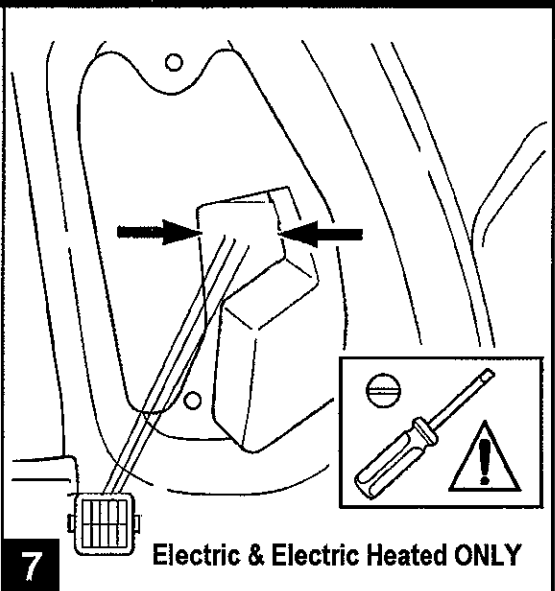

7

Electric & Electric Heated ONLY

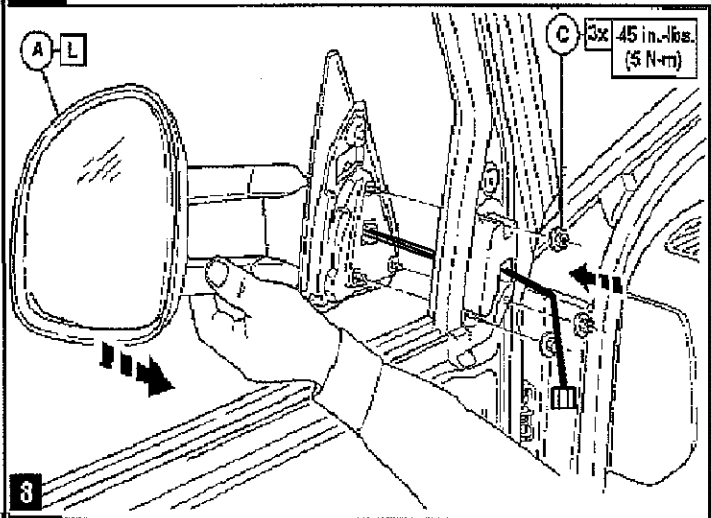

8

Once you have the mirrors installed, bolted in place and plugged into the connectors, test the function of the mirror glass; i.e. up / down & in / out. If both mirrors function properly, re-assemble the door panels and switches in the reverse order used for removal.