

# CATCO<sup>®</sup>

CATALYTIC CONVERTERS

Worldwide Source for Technologically Advanced Catalytic Converters

**EPA OBD II & PRE-OBD II  
CATALYTIC CONVERTERS  
DIRECT FIT & UNIVERSAL**



**EPA  
COMPLIANT  
STATES**

**CATALYTIC  
CONVERTER  
CATALOG**

Direct Fit | Universal | OBDII  
Convertidores Catalíticos MONTAJE DIRECTO · UNIVERSAL · OBDII  
Convertisseurs Catalytiques INSTALLATION DIRECTE · UNIVERSAL · OBDII

## CATALYTIC CONVERTERS

The Right Choice For Today's Complex OBDII Systems

### OBD II ENGINEERED CATALYTIC CONVERTER

THREE-WAY No/Air OBD II BY DESIGN US-EPA COMPLIANT Catalytic Converters are efficient at the oxidation of HC's and CO, and very efficient at the reduction of NOx, storing O<sub>2</sub>, and the steady release of O<sub>2</sub> into the exhaust stream.

Designed to deal with the specific demands of today's OBD II engine operating systems and emission gas levels.

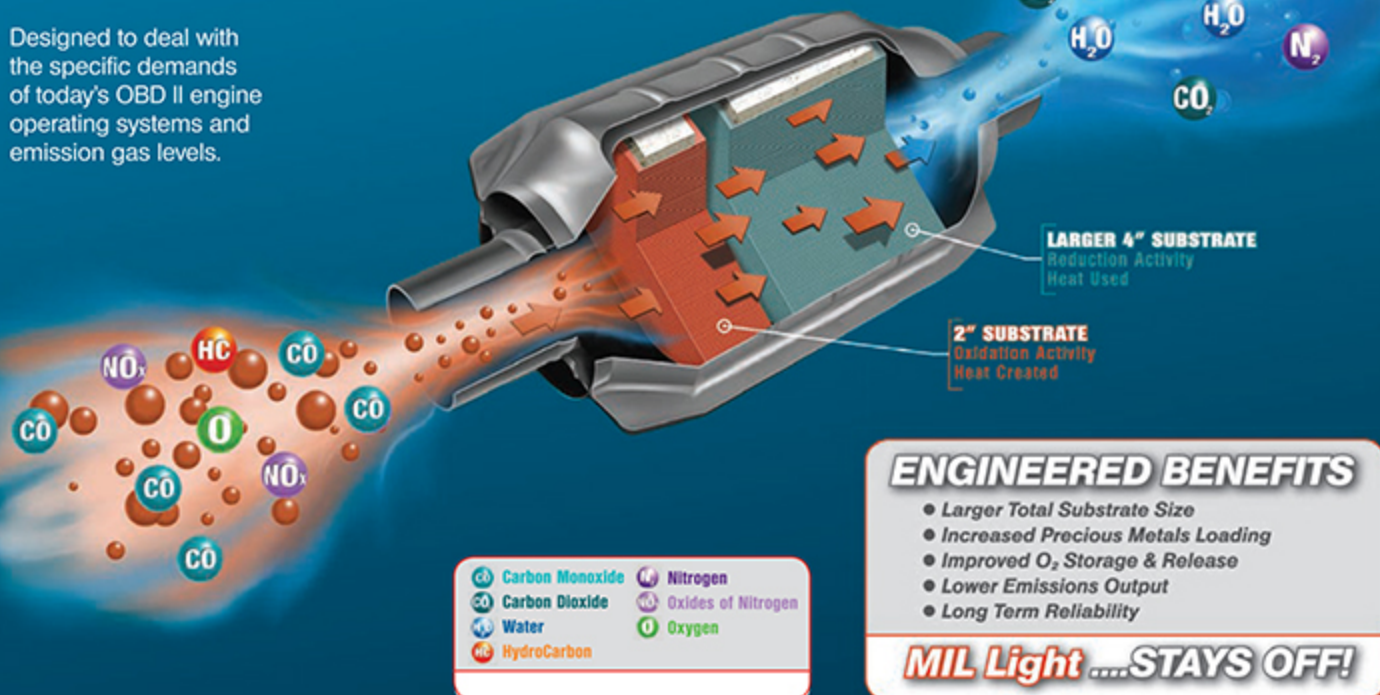

### STANDARD DUTY CATALYTIC CONVERTER

THREE-WAY No/Air Catalytic Converters have been the automotive standard converter since the compliance to U.S. EPA criteria was established in the Mid 1980s. They are efficient at catalyzing HC's, CO, and NOx. These converters reduce NOx, then use the released O to oxidize the remaining HC, and CO in the exhaust. H<sub>2</sub>O, CO<sub>2</sub>, O<sub>2</sub>, and N<sub>2</sub> are produced as by-products.

Adequate for use with 1980's to mid 1990's engine operating systems and engine exhaust gas levels.

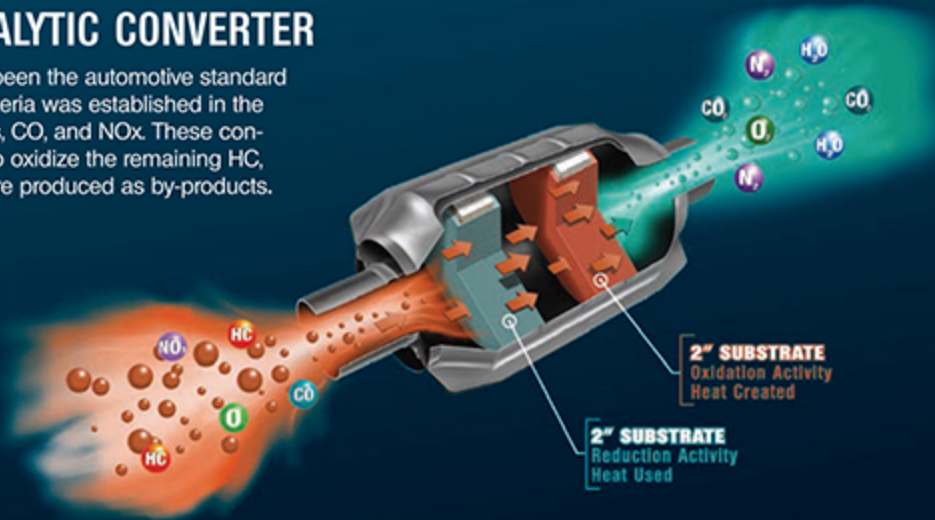

## **HOW TO USE THIS CATALOG**

1. Check Index listings below to determine your specific needs. Use corresponding tabs to go to pages listed by type.
2. You should read all descriptions in each area to determine legalities, weight restrictions and other important application information.

GENERAL INFORMATION & UNIVERSAL CONVERTER LISTINGS .....	1
APPLICATION LISTINGS, PASSENGER CARS & TRUCKS .....	47
DIRECT FIT NUMERICAL LISTINGS & ILLUSTRATIONS .....	237
ACCESSORIES .....	470
SUPERSESSIONS .....	489

## GENERAL INFORMATION

### HOW TO USE THIS CATALOG

Passenger car/truck application index is on pages 4-8.

Refer to the page number indicated for the Make/Model.

- Find the Year, Model, and Engine Size which is located in the first three left hand columns.
- Read across the page to find the recommended converter required.
- The "Direct Fit" column lists the Direct Fit Converter; the "Universal" lists Recommended Universal converter. Specifics, such as, Front or Rear, Right, or Main plus Pre-Cat or 2 to 1 coverage, are noted in the "Description" field.

This catalog has been developed with OEM parts information. Photos and measurements are for identification purposes ONLY. Catalog photos and illustrations are printed as a sales aid/identification ONLY. No responsibility can be assumed should some reference, photo or illustration prove to be inaccurate. If inaccuracy or errors are found, they should be reported to **1-800-277-2787**.

### ABBREVIATIONS

A.I.R.	...	Air Injection Reactor
AT.	...	Automatic Transmission
AW D	...	All Wheel Drive
BBL.	...	Barrel
C.A.R.B.	...	California Air Resources Board
Carb	...	Carburetor
CFI	...	Central Fuel Injection
C.I.D.	...	Cubic Inch Displacement
CA/CALIF.	...	California
CO	...	Carbon Monoxide
CY L.	...	Cylinder
DTC.	...	Diagnostic Trouble Code
EEC.	...	Electronic Engine Control
ECM	...	Electronic Control Module
EFC.	...	Engine Family Code
EFI	...	Electronic Fuel Injection
EFN.	...	Engine Family Number
EGR	...	Exhaust Gas Recirculation
EPA.	...	Environment Protection Agency
EX C.	...	Except/Excluding
FW D	...	Front Wheel Drive
HC	...	Hydrocarbon
H.O.	...	High Output
I.D.	...	Inside Diameter
IM.	...	Inspection Maintenance
INJ	...	Injection
MFI	...	Multipoint Fuel Injection
MIL	...	Malfunction Indicator Light
MT	...	Manual Transmission
NOX	...	Oxides of Nitrogen
O.B.D.	...	On Board Diagnostics
O.B.D. I.	...	On Board Diagnostics, First Generation
O.B.D. II	...	On Board Diagnostics, Second Generation
OC	...	2 Way Converter (Oxidation Converter)
O.D.	...	Outside Diameter
O.E.M.	...	Original Equipment Manufacturer
PPM	...	Parts per Million
RW D	...	Rear Wheel Drive
SAE.	...	Society of Automotive Engineers
SFI	...	Sequential Fuel Injection
TBI	...	Throttle Body Injection
TPI	...	Tuned Port Injection
TWC	...	3 Way Converter
TWC/OC	...	3 Way Converter, with Air
2W D	...	2 Wheel Drive
4W D	...	4 Wheel Drive

### ENG. SIZE CONVERSION TABLE

LITER	C.I.D.	LITER	C.I.D.
1.0	61	4.0	241
1.3	79	4.1	250,252
1.4	85	4.2	255,258
1.5	92	4.3	261,267
1.6	98	4.6	283
1.7	104	4.9	300,301
1.8	105,110,112	5.0	302,305,307
1.9	116	5.2	318
2.0	122	5.3	323
2.2	134,135	5.4	329
2.3	140	5.7	350
2.5	150,151,153	5.8	351
2.6	156,159	5.9	360
2.7	164,165	6.0	368
2.8	171,173	6.4	390
2.9	177	6.6	400,403
3.0	183	6.8	415
3.1	189	7.0	427
3.2	195	7.2	440
3.3	200	7.3	444
3.4	207,208	7.4	454
3.5	214	7.5	455
3.7	225	7.7	470
3.8	229,231	8.0	488
3.9	239	8.2	500

### TO CALCULATE C.I.D. / LITER ENG. DISPLA

**Cubic Inch to Liter:** 1 cubic inch = .01639 liter  
 Example: 351 x .01639 = 5.8(5.75289)

**Liter to Cubic Inch:** 1 Liter = 61.02 cubic inches  
 Example: 5.8(5.75289) x 61.02 = 351 cubic inches

**GENERAL INFORMATION****READINESS DRIVE CYCLE TEST**

After all repairs have been made, any trouble codes have been erased and the MIL has been turned off, you will need to perform a Readiness Drive Cycle Test before any emissions tests can be properly done. OBD II systems conduct self-diagnostic system tests under certain conditions or enabling criteria, as listed below.

1. Elapsed time since vehicle engine start up
2. Engine temperature
3. Throttle position
4. Engine speed
5. Vehicle speed

Most of the various system tests, conducted by the different monitors, are performed when the engine has reached normal operating temperature.

The computer runs three types of tests:

1. **Passive Tests** - These are the tests that monitor a system or component without affecting its operation.
2. **Active Tests** - These are the tests where the computer has the monitor produce a test signal so that its response can be checked against stored information.
3. **Intrusive Tests** - These are the tests where the computer performs system checks that directly affect vehicle performance and emissions.

After a passive test is run and a failure is detected, the computer then performs an active test procedure on the system. If, after the active test, another failure is detected the computer will run an intrusive test. If after the intrusive test another failure is confirmed, the computer may not, at this time, store a trouble code and/or illuminate the MIL until after this same failure occurs after two consecutive test series are completed. Because of this characteristic, it is suggested that you perform the following I/M Readiness Drive Cycle Test TWICE to be sure that all sub-systems have been checked, flags are set and all I/M monitors are in the ready condition. It is important that these benchmarks or messages the OBD II system uses indicate that all emission monitors have been run before the vehicle is released to the consumer or goes through an I/M 240 test.

**I/M READINESS DRIVE CYCLE TEST PROCEDURE**

1. Vehicle should be started with the engine cold.
2. Let vehicle idle until the engine is at normal operating temperature (the engine coolant temperature sensor should read 180° F or higher). Generally 5 to 10 minutes is sufficient depending on outside ambient temperature.
3. Put vehicle in gear (with brake applied) and idle for no less than 45 seconds.
4. Accelerate to 45 MPH with no more than ¼ throttle and maintain speed for a full 10 seconds.
5. Decelerate to 35-38 MPH and maintain a steady throttle and speed for 1 minute.
6. Decelerate to 25 MPH and then operate between 25 MPH and 40 MPH for 4 minutes. DO NOT operate at more than ¾ throttle for this test segment.
7. Decelerate and idle engine for 10 seconds.
8. Accelerate gently to 55 MPH using NO MORE than ½ throttle, maintain speed for a full 10 seconds.
9. Continue driving at 40 MPH – 55 MPH, Use a steady throttle pressure and maintain speed for a full 2 minutes.
10. Return to your shop and shut the vehicle off.

**IT IS RECOMMENDED THAT THE ABOVE I/M READINESS DRIVE CYCLE TEST BE CONDUCTED A SECOND TIME.**

If time permits, it is in your best interest to run the cycle again after the vehicle has COOLED down. Doing this second Readiness Drive Cycle Test should insure that all problems have been repaired, Flags have been set, all monitors are in the ready condition, the MIL will remain out, and the vehicle is ready to pass an I/M 240 test.

If the MIL comes back on during Drive Cycle Test 1 or 2, then further repairs are most likely needed or you did not perform the Drive Cycle Test properly. It is better that you discover this before you return the vehicle to the customer allowing you to complete the needed repairs.

### TABLE OF CONTENTS

Applications / Index.....	
Warranty / General Info.....	5-9
Universal Specifications.....	10-13
Universal Listings / Illustrations .....	36-46
Application Listings, Passenger Cars & Trucks.....	48-236
Numerical Listings / Illustrations ....	237-469
Accessories.....	470-488

### APPLICATIONS (INDEX)

ACURA .....	48	GMC .....	136	NISSAN/DATSUN .....	187
AL FA ROMEO .....	50	HONDA .....	147	OL DSMOBIL E .....	193
AMERICAN MOTORS .....	50	HUMMER .....	151	OPEL .....	198
ASTON MARTIN .....	51	HYUNDAI .....	151	PASSPORT .....	198
ASUNA (Ca n a. d. a.) .....	51	INFINITI .....	154	PEUGEOT .....	198
AUDI .....	51	INTERNATIONAL HARV ESTER .....	156	PL YMOUTH .....	199
AV ANTI .....	54	ISUZU .....	156	PONTIAC .....	203
BERTONE .....	54	JAGUAR .....	157	PORSCHE .....	211
BL UE BIRD BUS .....	54	JEEP .....	158	RAM .....	212
BMW .....	54	K IA .....	161	RENAUL T .....	212
BUICK .....	59	L ADA (Ca n a. d. a.) .....	163	SAAB .....	213
CADIL L AC .....	65	L ANCIA .....	163	SATURN .....	214
CHECK ER .....	69	L AND ROV ER .....	164	SCION .....	218
CHEV ROL ET .....	69	L EXUS .....	164	SMART .....	218
CHRYSL ER .....	89	L INCOL N .....	166	STERL ING .....	218
DAEW OO .....	95	L OTUS .....	170	SUBARU .....	219
DAIHATSU .....	96	MASERATI .....	170	SUZUK I .....	222
DEL OREAN .....	96	MAZDA .....	170	TOYOTA .....	223
DODGE .....	96	MERCEDES-BENZ .....	175	TRIUMPH .....	231
EAGL E .....	108	MERCURY .....	177	V OL K SW AGEN .....	231
FIAT .....	109	MERK UR .....	184	V OL V. O .....	234
FORD .....	109	MINI COOPER .....	184	W ORK HORSE W. 42 .....	236
GEO .....	136	MITSUBISHI .....	184	YUGO .....	236

**GENERAL INFORMATION**

**UNIVERSAL SPECIFICATIONS**

**SPECIFICATIONS FOR UNIVERSAL CONVERTERS**

All Converter Series comply with EPA policies. Application exceptions are noted in this catalog.

**THE 6000 Series CAN BE USED:**

As a **TWO-WAY (TW-WAY)** Universal and Direct Fit: With an Eng. displacement of 5.9L or less, and vehicle test weight of 6000 lbs or less.

As a **THREE-WAY (THREE-WAY)** Universal and Direct Fit: With an Eng. displacement of 5.9L or less, and vehicle test weight of 6000 lbs or less.

As a **THREE-WAY + OXIDATION (THREE-WAY + OXIDATION)** Universal and Direct Fit: With an Eng. displacement of 5.9L or less, and vehicle test weight of 6000 lbs or less.

**6000 Series** can be used as a 2 to 1 replacement on Three-Way w/Air applications: With an Eng. displacement of 5.8L or less, and vehicle test weight of 5000 lbs or less.

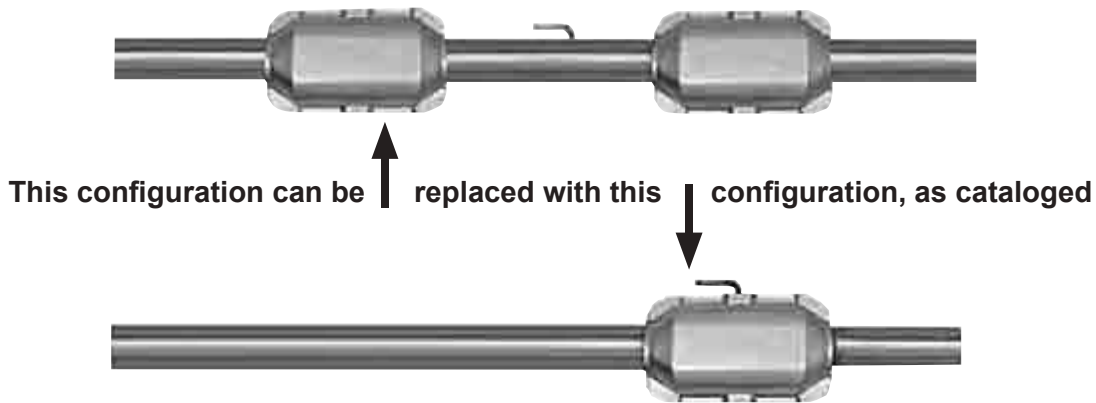

**6000 Series** can also be used to replace up to 2 Pre-Cats when used in Three-Way w/Air applications as the under body converter, with an Eng. displacement of 5.2L or less, and vehicle test weight of 4000 lbs or less.

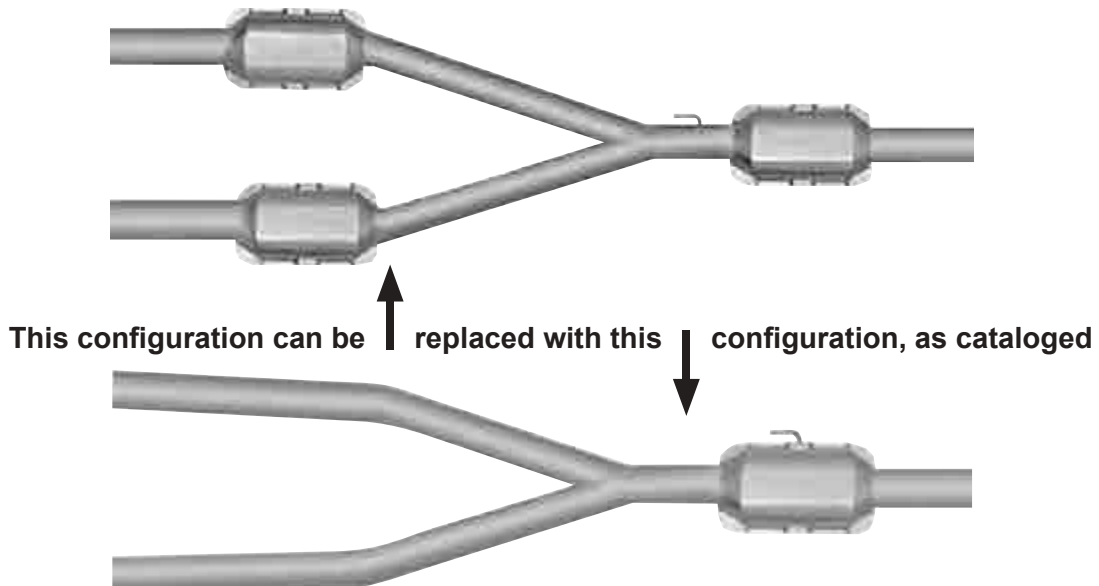

# GENERAL INFORMATION

## UNIVERSAL SPECIFICATIONS

### SPECIFICATIONS FOR UNIVERSAL CONVERTERS-(cont.)

All Converter Series comply with EPA policies. Application exceptions are noted in this catalog.

#### THE 2600 Series CAN BE USED:

As a **TWO-WAY (TWO-WAY)** Universal and Direct Fit: With an Eng. displacement of 5.9L or less, and vehicle test weight of 6000 lbs or less.

As a **THREE-WAY (THREE-WAY)** Universal and Direct Fit: With an Eng. displacement of 5.9L or less, and vehicle test weight of 6000 lbs or less.

As a **THREE-WAY + OXIDATION (THREE-WAY + OXIDATION)** Universal and Direct Fit: With an Eng. displacement of 5.9L or less, and vehicle test weight of 6000 lbs or less.

**2600 Series** can also be used to replace up to 2 Pre-Cats when used in Three-Way w/Air applications as the under body converter, with an Eng. displacement of 5.2L or less and vehicle test weight of 4000 lbs or less.

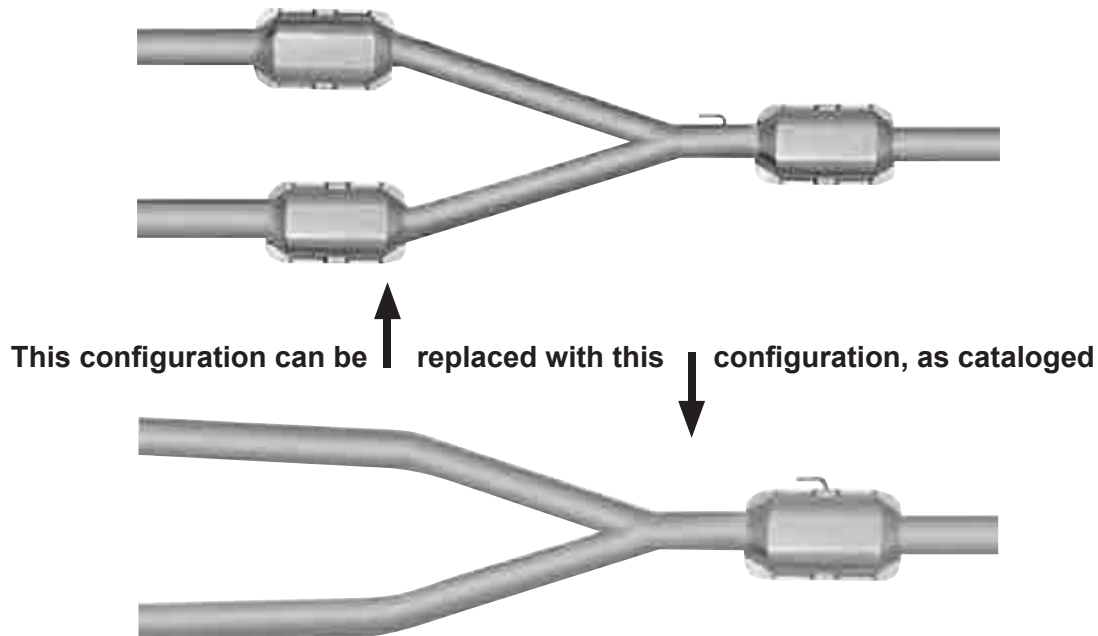

#### THE 8000 Series CAN BE USED:

As a **TWO-WAY (TWO-WAY)** Universal and Direct Fit: With an Eng. displacement of 7.7L or less, and vehicle test weight of 7000 lbs or less.

As a **THREE-WAY (THREE-WAY)** Universal and Direct Fit: With an Eng. displacement of 7.5L or less, and vehicle test weight of 7000 lbs or less.



**GENERAL INFORMATION**

**UNIVERSAL SPECIFICATIONS**

**SPECIFICATIONS FOR UNIVERSAL CONVERTERS-(cont.)**

All Converter Series comply with EPA policies. Application exceptions are noted in this catalog.

**THE 9000 Series CAN BE USED:**

As a **TWO-WAY (TW, UC)** Universal and Direct Fit: With an Eng. displacement of 7.7L or less, and vehicle test weight of 7000 lbs or less.

As a **THREE-WAY (TW, UC)** Universal and Direct Fit: With an Eng. displacement of 7.5L or less, and vehicle test weight of 7000 lbs or less.

As a **THREE-WAY + OXIDATION (TW, UC + OX)** Universal and Direct Fit: With an Eng. displacement of 7.5L or less, and vehicle test weight of 7000 lbs or less.

**9000 Series** can be used as a 2 for 1 replacement in Three-Way w/Air applications: with an Eng. displacement of 5.9L or less, and vehicle test weight of 7000 lbs.

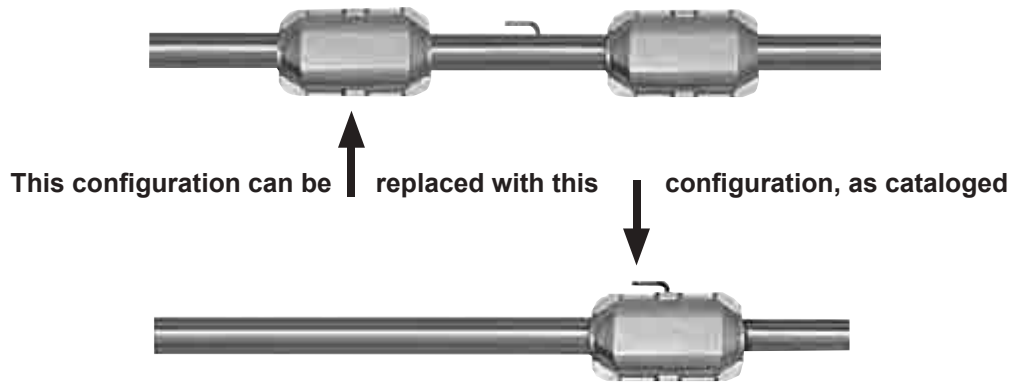

**9000 Series** converters can also be used to replace up to 2 PRE-CATS when used as the main converter, in Three-Way w/Air applications, with an Eng. displacement of 5.2L or less, and vehicle test weight of 5500 lbs or less.

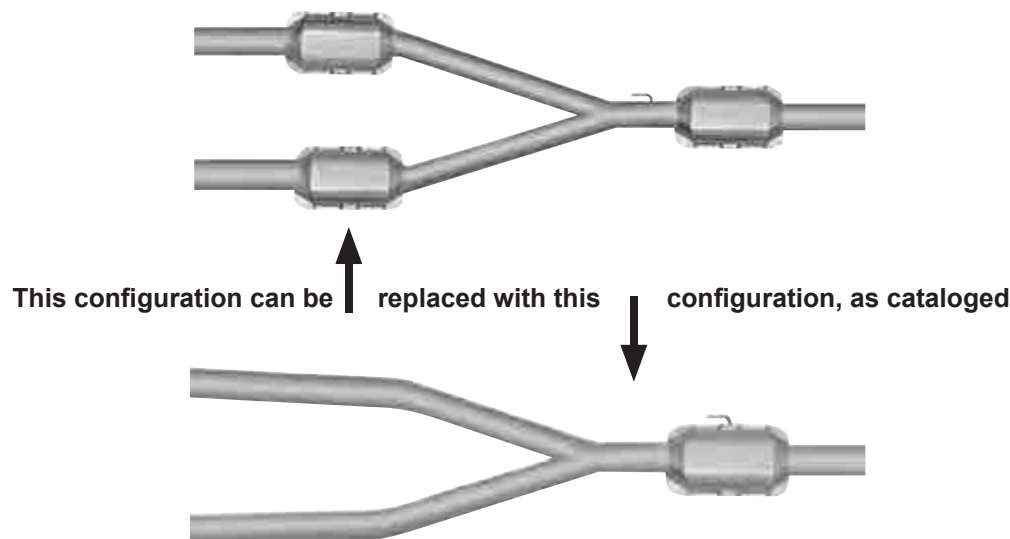

# GENERAL INFORMATION



## UNIVERSAL SPECIFICATIONS

### SPECIFICATIONS FOR UNIVERSAL CONVERTERS-(cont.)

All Converter Series comply with EPA policies. Application exceptions are noted in this catalog.

#### 10900 Series CAN BE USED:

As a **TWO-WAY (TWC)** Universal and Direct Fit: With an Eng. displacement of 7.5L or less, and vehicle test weight of 9000 lbs or less.

As a **THREE-WAY (TWC)** Universal and Direct Fit: With an Eng. displacement of 7.5L or less, and vehicle test weight of 9000 lbs or less.

#### 10000 Series CAN BE USED:

As a **TWO-WAY (TWC)** Universal and Direct Fit: With an Eng. displacement of 7.5L or less, and vehicle test weight of 9000 lbs or less.

As a **THREE-WAY (TWC)** Universal and Direct Fit: With an Eng. displacement of 7.5L or less, and vehicle test weight of 9000 lbs or less.

As a **THREE-WAY + OXIDATION (TWC+UO)** Universal and Direct Fit: With an Eng. displacement of 7.5L or less, and vehicle test weight of 9000 lbs or less.

#### 2500 Series (OBD II EPA ONLY)

As a **THREE-WAY (TWC)** Universal and Direct Fit: With an Eng. displacement of 5.9L or less, and vehicle test weight of 6250 lbs or less.

As a **THREE-WAY + OXIDATION (TWC+UO)** Universal and Direct Fit: With an Eng. displacement of 5.9L or less, and vehicle test weight of 6250 lbs or less.

#### 2900 Series CAN BE USED:

As a **TWO-WAY (TWC)** Universal and Direct Fit: With an Eng. displacement of 5.9L or less, and vehicle test weight of 7000 lbs or less.

As a **THREE-WAY (TWC)** Universal and Direct Fit: With an Eng. displacement of 5.9L or less, and vehicle test weight of 7000 lbs or less.

As a **THREE-WAY + OXIDATION (TWC+UO)** Universal and Direct Fit: With an Eng. displacement of 5.9L or less, and vehicle test weight of 7000 lbs or less.

**2900 Series** can be used as a 2 for 1 replacement in Three-Way w/Air applications on vehicles, with an Eng. displacement of 5.9L or less, and vehicle test weight of 6515 lbs or less.

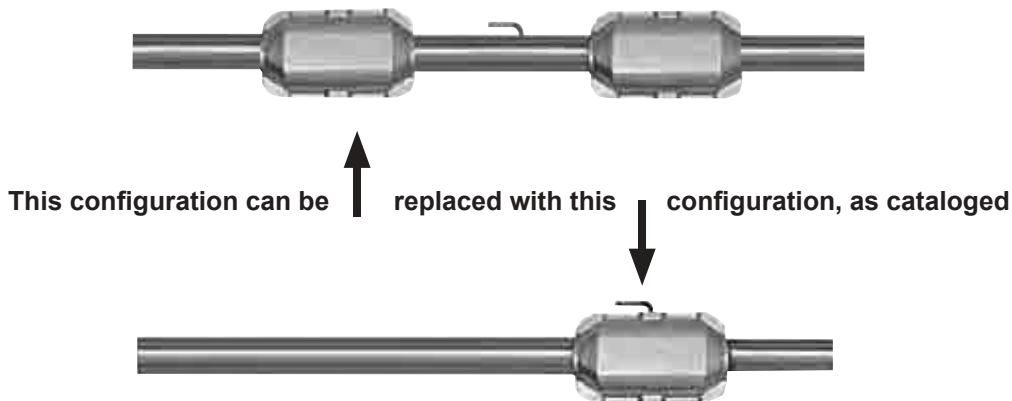

## 2200 Series HIGH FLOW

HIGH FLOW	EPA Eng./Test Weight
2-W AY	5.7L, 6000 lbs
3-W AY	5.7L, 6000 lbs

**Round - Small Body, OBDII EPA Only, w/o Air tube, 200 Cell Stainless Steel Substrate**

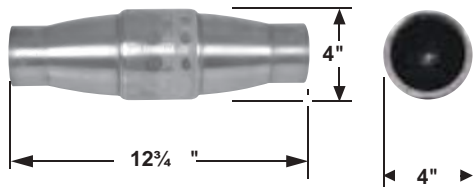

	INLET/I.D.	OUTLET/I.D.
<b>2224</b>	2"	2" w/o air tube
<b>2225</b>	2-1/4"	2-1/4" w/o air tube
<b>2226</b>	2-1/2"	2-1/2" w/o air tube

**Round - Large Body, OBDII EPA Only, w/o Air tube, 200 Cell Stainless Steel Substrate**

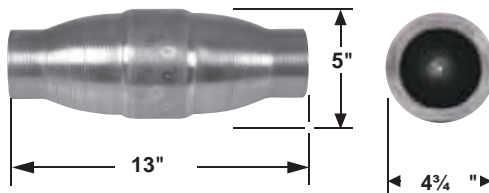

	INLET/I.D.	OUTLET/I.D.
<b>2246</b>	2-1/2"	2-1/2" w/o air tube
<b>2247</b>	3"	3" w/o air tube

## 2300 Series - OBDII Vehicles up to L EV

EPA OBD II	EPA Eng./Test Weight
2-W AY	5.9L, 5500 lbs
3-W AY	5.9L, 5500 lbs

### EPA OBDII BY DESIGN

Made to keep the "Light Off" (MIL check engine light).

**Round - No Necks, w/o Air Tube**

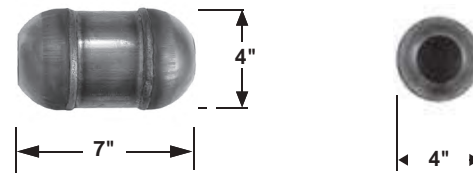

	INLET/I.D.	OUTLET/I.D.
<b>2384R</b>	2"	2"
<b>2385R</b>	2-1/4"	2-1/4"
<b>2386R</b>	2-1/2"	2-1/2"

**Round - No Necks, w/o Air Tube**

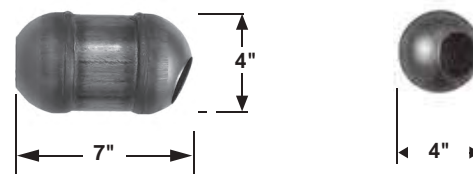

	INLET/I.D.	OUTLET/I.D.
<b>2394R</b>	2" Angled	2"
<b>2395R</b>	2-1/4" Angled	2-1/4"
<b>2396R</b>	2-1/2" Angled	2-1/2"

## GENERAL INFORMATION

INFORMACIÓ N GENERAL | INFORMATIONS GÉ NÉ RAL ES

### UNIVERSAL CONVERTER SPECIFICATIONS

#### 2500 Series OBDII Vehicles up to

EPA OBD II      EPA Eng./Test Weight

#### EPA OBDII BY DESIGN

Made to keep the "Light Off" (MIL check engine light).

3-W AY	5.9L, 6250 lbs
3-W AY w/Air	5.9L, 6250 lbs

*Units have O2 Sensor port in Outlet, unless otherwise noted*

#### Oval - w/o Air Tube

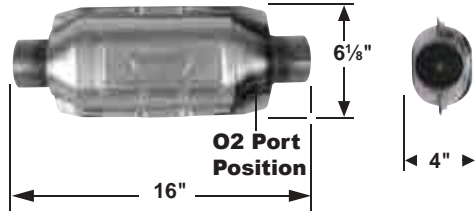

	INLET/I.D.	OUTLET/I.D.
<b>2504</b>	2"	2" w/O2 Sensor port
<b>2505</b>	2-1/4"	2-1/4" w/O2 Sensor port
<b>2506</b>	2-1/2"	2-1/2" w/O2 Sensor port
<b>2507</b>	3"	3" w/O2 Sensor port

#### Round - w/o Air Tube

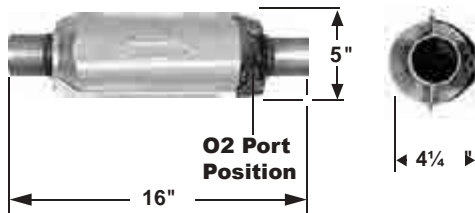

	INLET/I.D.	OUTLET/I.D.
<b>2504R</b>	2"	2" w/O2 Sensor port
<b>2505R</b>	2-1/4"	2-1/4" w/O2 Sensor port
<b>2506R</b>	2-1/2"	2-1/2" w/O2 Sensor port
<b>2507R</b>	3"	3" w/O2 Sensor port

#### Oval - w/o Air Tube

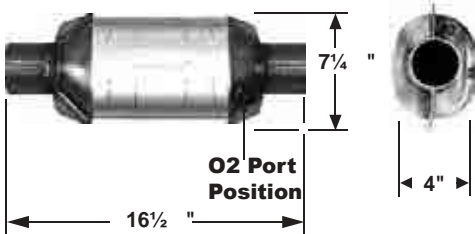

	INLET/I.D.	OUTLET/I.D.
<b>2514</b>	2"	2" w/O2 Sensor port
<b>2515</b>	2-1/4"	2-1/4" w/O2 Sensor port
<b>2516</b>	2-1/2"	2-1/2" w/O2 Sensor port
<b>2517</b>	3"	3" w/O2 Sensor port

#### Oval - w/o Air Tube

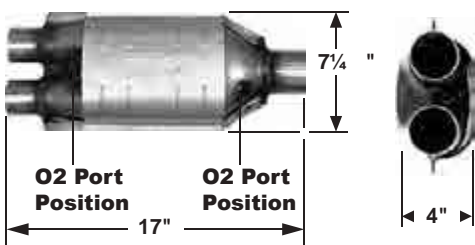

	INLET/I.D.	OUTLET/I.D.
<b>2513</b>	2" Dual	2-1/2" w/Two O2 Sensor ports

#### Oval - w/Air Tube

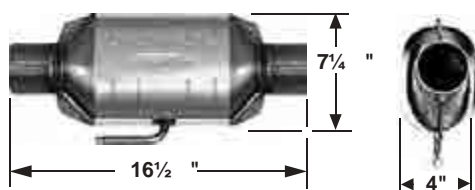

	INLET/I.D.	OUTLET/I.D.
<b>2526</b>	2-1/2"	2-1/2" w/air tube

### 2500 Series - (cont.) OBDII V ehicles u p

#### EPA OBDII BY DESIGN

Made to keep the " Light Off" (MIL check engine light).

EPA OBD II	EPA Eng./Test W eight
3-W AY	5.9L, 6250 lbs
3-W AY w/Air	5.9L, 6250 lbs

Units have O2 Sensor port in Outlet, unless otherwise noted

#### Oval - w/o Air Tube

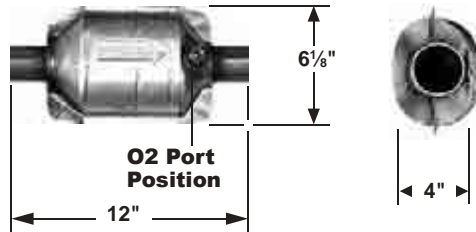

	INLET/I.D.	OUTLET/I.D.
<b>2538</b>	2"	2" w/O2 Sensor port
<b>2545</b>	2-1/4"	2-1/4" w/O2 Sensor port

#### Oval - w/o Air Tube

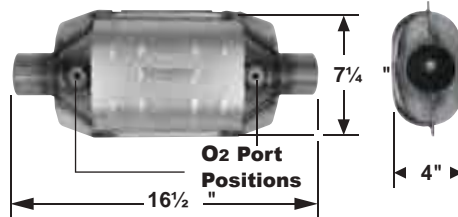

	INLET/I.D.	OUTLET/I.D.
<b>2539</b>	2"	2" w/Two O2 Sensor ports
<b>2540</b>	2-1/4"	2-1/4" w/Two O2 Sensor ports

#### Round - w/o Air Tube

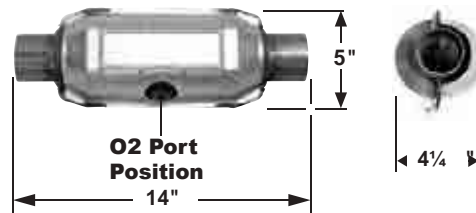

	INLET/I.D.	OUTLET/I.D.
<b>2534R</b>	2"	2" w/O2 sensor port at middle of shell
<b>2535R</b>	2-1/4"	2-1/4" w/O2 sensor port at middle of shell
<b>2536R</b>	2-1/2"	2-1/2" w/O2 sensor port at middle of shell

#### Spun Body one-piece design Round - w/o Air Tube

OBDII By Design, EPA, 5.9L to 6000 lbs

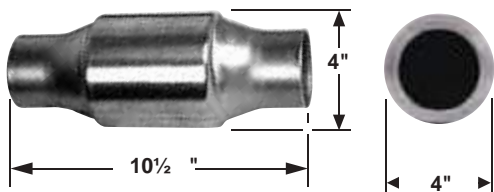

	INLET/I.D.	OUTLET/I.D.
<b>608384</b>	2"	2"
<b>608385</b>	2-1/4"	2-1/4"
<b>608395</b>	2-1/4"	2-1/4" w/O2 Sensor Fitting
<b>608386</b>	2-1/2"	2-1/2"
<b>608396</b>	2-1/2"	2-1/2" w/O2 Sensor Fitting
<b>608387</b>	3"	3"
<b>608397</b>	3"	3" w/O2 Sensor Fitting

# GENERAL INFORMATION

INFORMACIÓ N GENERAL | INFORMATIONS GÉ NÉ RAL ES

## UNIVERSAL CONVERTER SPECIFICATIONS

### 2500 Series LEV II and Cleaner Application

#### EPA OBDII BY DESIGN

These parts utilize a higher precious metal loading for LEV II and cleaner emission standards.

EPA OBD II	EPA Eng./Test Weight
3-W AY	5.9L, 6250 lbs
3-W AY w/Air	5.9L, 6250 lbs

#### Special Body - Angled Inlet and Outlet, w/o Air Tube

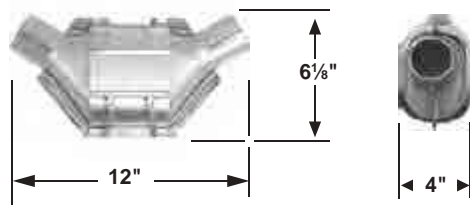

	INLET/I.D.	OUTLET/I.D.
<b>2554</b>	2"	2"
<b>2555</b>	2-1/4"	2-1/4"
<b>2556</b>	2-1/2"	2-1/2"

#### Special Body - Angled Inlet, w/o Air Tube

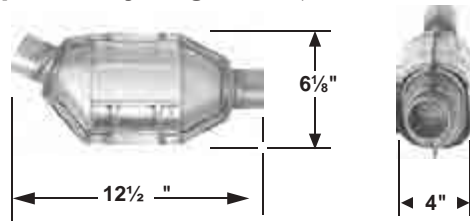

	INLET/I.D.	OUTLET/I.D.
<b>2564</b>	2"	2"
<b>2565</b>	2-1/4"	2-1/4"
<b>2566</b>	2-1/2"	2-1/2"

#### Oval - w/o Air Tube

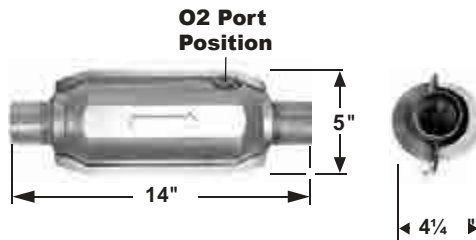

	INLET/I.D.	OUTLET/I.D.
<b>2564R</b>	2"	2" w/O2 Sensor port
<b>2565R</b>	2-1/4"	2-1/4" w/O2 Sensor port
<b>2566R</b>	2-1/2"	2-1/2" w/O2 Sensor port

#### Round - w/o Air Tube

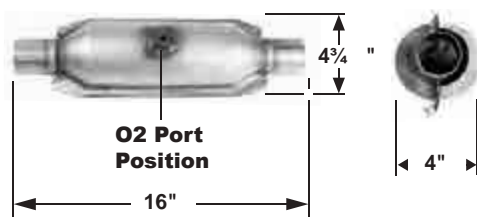

	INLET/I.D.	OUTLET/I.D.
<b>2573R</b>	2"	2" w/O2 sensor port at middle of shell
<b>2578R</b>	2-1/4"	2-1/4" w/O2 sensor port at middle of shell

#### Round - w/o Air Tube

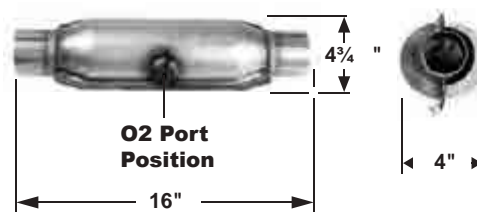

	INLET/I.D.	OUTLET/I.D.
<b>2571R</b>	2-1/2"	2-1/2" w/O2 sensor port at middle of shell

EPA ONLY - Not for sale or installation in California  
 EPA Solamente - No para Venta o Instalacion en California  
 Seulement EPA - Ne peut pas être vendu et installé en Californie

### 2500 Series - (cont.) LEV II and Cleaner App

#### EPA OBDII BY DESIGN

These parts utilize a higher precious metal loading for LEV II and cleaner emission standards.

EPA OBD II	EPA Eng./Test Weight
3-W AY	5.9L, 6250 lbs
3-W AY w/Air	5.9L, 6250 lbs

#### Round - w/o Air Tube

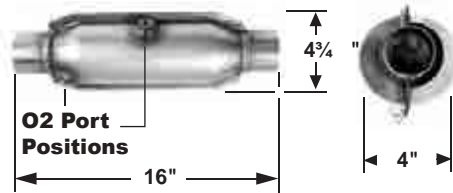

#### INLET/I.D.

#### OUTLET/I.D.

2572R

2-1/2"

2-1/2" w/Two O2 sensor ports, one at middle of shell & one at left top inlet

#### Oval - w/o Air Tube

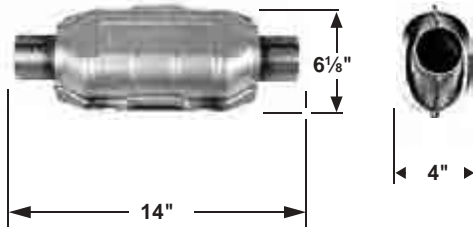

#### INLET/I.D.

#### OUTLET/I.D.

2574

2"

2"

2575

2-1/4"

2-1/4"

2576

2-1/2"

2-1/2"

2577

3"

3"

#### Round - w/o Air Tube

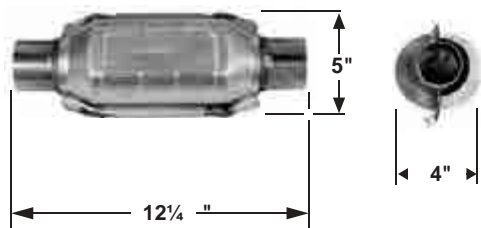

#### INLET/I.D.

#### OUTLET/I.D.

2574R

2"

2"

2575R

2-1/4"

2-1/4"

2576R

2-1/2"

2-1/2"

2577R

3"

3"

#### Oval - w/o Air Tube

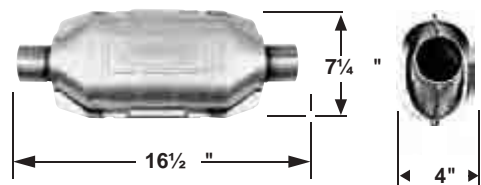

#### INLET/I.D.

#### OUTLET/I.D.

2584

2"

2"

2585

2-1/4"

2-1/4"

2586

2-1/2"

2-1/2"

2587

3"

3"

## GENERAL INFORMATION

INFORMACIÓ N GENERAL | INFORMATIONS GÉ NÉ RAL ES

### UNIVERSAL CONVERTER SPECIFICATIONS

## 2600 Series

### MEDIUM DUTY

MEDIUM DUTY	EPA Eng./Test Weight
2-W AY	5.9L, 5500 lbs
3-W AY	5.9L, 5500 lbs
3-W AY , w/Air	5.9L, 5500 lbs

#### Oval - w/Air Tube

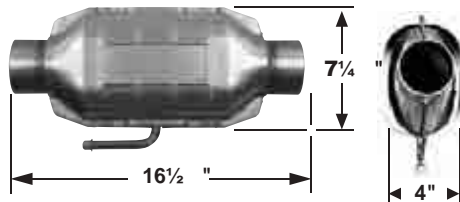

	INLET/I.D.	OUTLET/I.D.
<b>2606</b>	2-1/2"	2-1/2" w/air tube
<b>2607</b>	3"	3" w/air tube

#### Oval

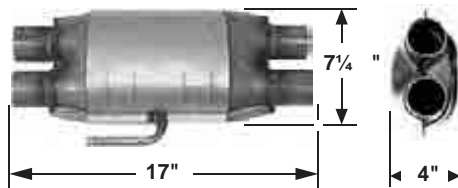

	INLET/I.D.	OUTLET/I.D.
<b>2612</b>	2" Dual Inlets	2" Dual Outlets, w/air tube

#### Oval - w/Air Tube

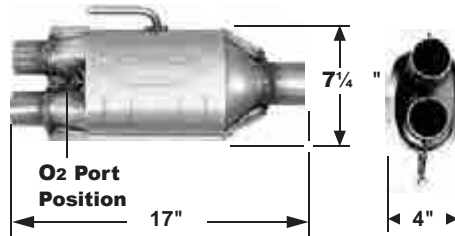

	INLET/I.D.	OUTLET/I.D.
<b>2613</b>	2" Dual Inlets w/O2 Sensor port	2-1/2" w/air tube

#### Oval - w/o Air Tube

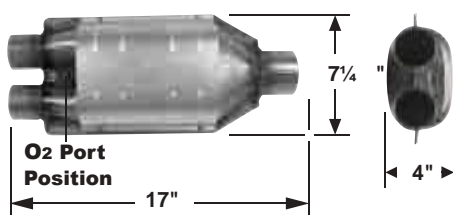

	INLET/I.D.	OUTLET/I.D.
<b>2613W</b>	2" Dual, w/O2 Sensor port	2-1/2"



### 2900 Series

#### LARGE BODY SUPER X DUTY

SPECIAL	EPA Eng./Test Weight
2-W AY	5.9L, 6515 lbs
3-W AY	5.9L, 6515 lbs
3-W AY , w/Air	5.9L, 6515 lbs

#### Oval - w/Air Tube

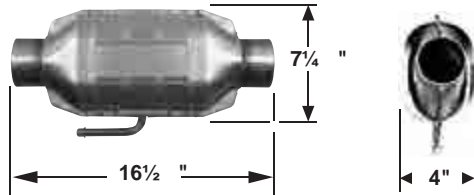

	INLET/I.D.	OUTLET/I.D.
<b>2904</b>	2"	2" w/air tube
<b>2905</b>	2-1/4"	2-1/4" w/air tube
<b>2906</b>	2-1/2"	2-1/2" w/air tube

#### Oval - w/o Air Tube

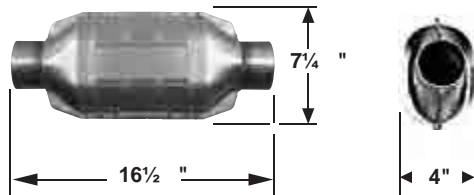

	INLET/I.D.	OUTLET/I.D.
<b>2907</b>	3"	3" w/o air tube

#### Oval

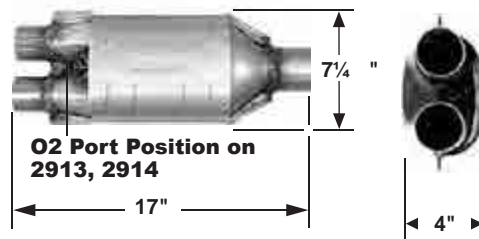

	INLET/I.D.	OUTLET/I.D.
<b>2908</b>	2" Dual	2-1/2" w/o air tube
<b>2913</b>	2" Dual, w/O <sub>2</sub> Sensor port	2-1/2" w/o air tube
<b>2914</b>	2" Dual, w/O <sub>2</sub> Sensor port	2-1/2" w/air tube

#### Oval - w/o Air Tube

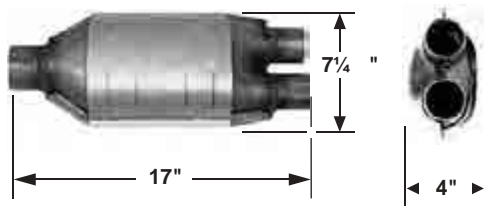

	INLET/I.D.	OUTLET/I.D.
<b>2910</b>	2-1/2"	2" Dual Outlets

## GENERAL INFORMATION

INFORMACIÓ N GENERAL | INFORMATIONS GÉ NÉ RAL ES

### UNIVERSAL CONVERTER SPECIFICATIONS

#### 2900 Series - (cont.)

##### LARGE BODY SUPER X DUTY

Oval - w/o Air Tube

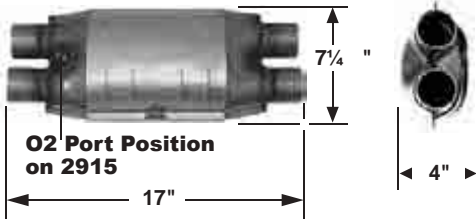

SPECIAL	EPA Eng./Test Weight
2-W AY	5.9L, 6515 lbs
3-W AY	5.9L, 6515 lbs
3-W AY , w/Air	5.9L, 6515 lbs

	INLET/I.D.	OUTLET/I.D.
<b>2912</b>	2" Dual	2" Dual
<b>2915</b>	2" Dual, w/O <sub>2</sub> Sensor port	2" Dual

#### 6000 Series

##### STANDARD DUTY

Oval - w/Air Tube

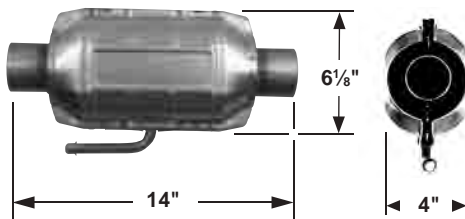

STANDARD DUTY	EPA Eng./Test Weight
2-W AY	5.9L, 5500 lbs
3-W AY	5.9L, 5500 lbs
3-W AY , w/Air	5.9L, 5500 lbs

	INLET/I.D.	OUTLET/I.D.
<b>6003</b>	1-3/4"	1-3/4" w/air tube
<b>6004</b>	2"	2" w/air tube
<b>6005</b>	2-1/4"	2-1/4" w/air tube
<b>6006</b>	2-1/2"	2-1/2" w/air tube
<b>6007</b>	3"	3" w/air tube

#### 6500 Series

##### ENHANCED STANDARD DUTY

Oval - w/Air Tube

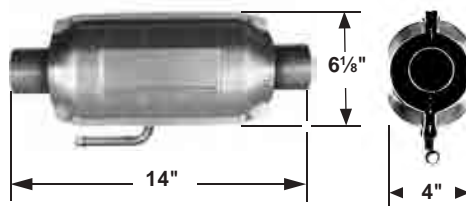

ENHANCED STANDARD DUTY	EPA Eng./Test Weight
2-W AY	5.9L, 6515 lbs
3-W AY	5.9L, 6515 lbs
3-W AY , w/Air	5.9L, 6515 lbs

	INLET/I.D.	OUTLET/I.D.
<b>6504</b>	2"	2" w/air tube
<b>6505</b>	2-1/4"	2-1/4" w/air tube

Can be used as alternate converters to 6000 and 6900 Series converters.

Oval - w/Air Tube

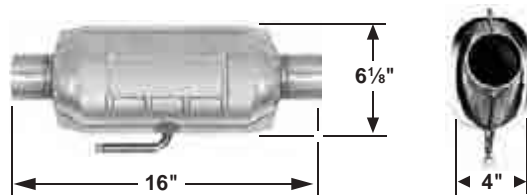

	INLET/I.D.	OUTLET/I.D.
<b>6574I</b>	2"	2" w/air tube
<b>6575I</b>	2-1/4"	2-1/4" w/air tube
<b>6576I</b>	2-1/2"	2-1/2" w/air tube
<b>6577I</b>	3"	3" w/air tube

Can be used as alternate converters to 6000, 6500 and 6900 Series converters.

### 6500 Series - (cont.)

#### ENHANCED STANDARD DUTY

##### Oval - w/o Air Tube

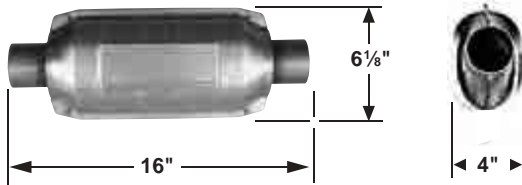

ENHANCED STANDARD DUTY	EPA Eng./Test Weight
2-W AY	5.9L, 6515 lbs
3-W AY	5.9L, 6515 lbs
3-W AY , w/Air	5.9L, 6515 lbs

	INLET/I.D.	OUTLET/I.D.
<b>6573</b>	1-3/4"	1-3/4" w/o air tube
<b>6574</b>	2"	2" w/o air tube
<b>6575</b>	2-1/4"	2-1/4" w/o air tube
<b>6576</b>	2-1/2"	2-1/2" w/o air tube
<b>6577</b>	3"	3" w/o air tube

Can be used as alternate converters to 6000, 6500 and 6900 Series converters.

##### Oval - w/o Air Tube

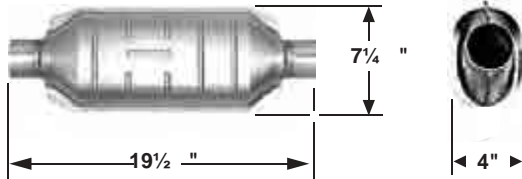

	INLET/I.D.	OUTLET/I.D.
<b>6595</b>	2-1/4"	2-1/4" w/o air tube

Can be used as alternate converters to 6000, 6500 and 6900 Series converters.

### 6800 Series

#### STANDARD DUTY

##### Oval - w/o Air Tube

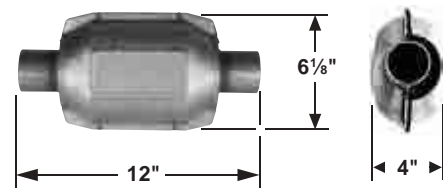

STANDARD DUTY	EPA Eng./Test Weight
2-W AY	5.9L, 5500 lbs
3-W AY	5.9L, 5500 lbs
3-W AY , w/Air	5.9L, 5500 lbs

	INLET/I.D.	OUTLET/I.D.
<b>6804</b>	2"	2"
<b>6805</b>	2-1/4"	2-1/4"
<b>6806</b>	2-1/2"	2-1/2"

### 6900 Series

#### STANDARD DUTY

##### Oval - w/o Air Tube

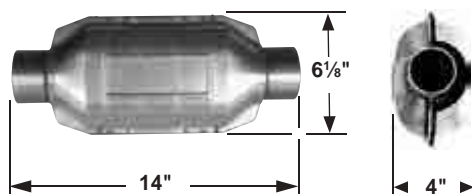

STANDARD DUTY	EPA Eng./Test Weight
2-W AY	5.9L, 5500 lbs
3-W AY	5.9L, 5500 lbs
3-W AY , w/Air	5.9L, 5500 lbs

	INLET/I.D.	OUTLET/I.D.
<b>6903</b>	1-3/4"	1-3/4" w/o air tube
<b>6904</b>	2"	2" w/o air tube
<b>6905</b>	2-1/4"	2-1/4" w/o air tube
<b>6906</b>	2-1/2"	2-1/2" w/o air tube
<b>6907</b>	3"	3" w/o air tube

EPA ONLY - Not for sale or installation in California  
 EPA Solamente - No para Venta o Instalacion en California  
 Seulement EPA - Ne peut pas être vendu et installé en Californie

## GENERAL INFORMATION

INFORMACIÓ N GENERAL | INFORMATIONS GÉ NÉ RAL ES

### UNIVERSAL CONVERTER SPECIFICATIONS

### 6900 Series

#### STANDARD DUTY

STANDARD DUTY	EPA Eng./Test Weight
2-W AY	5.9L, 5500 lbs
3-W AY	5.9L, 5500 lbs
3-W AY , w/Air	5.9L, 5500 lbs

#### Round - w/o Air Tube

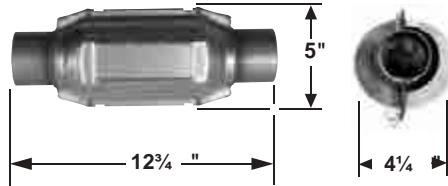

	INLET/I.D.	OUTLET/I.D.
<b>6903R</b>	1-3/4"	1-3/4" w/o air tube
<b>6904R</b>	2"	2" w/o air tube
<b>6905R</b>	2-1/4"	2-1/4" w/o air tube, 13" OAL
<b>6906R</b>	2-1/2"	2-1/2" w/o air tube, 13" OAL

#### Oval - w/O<sub>2</sub> port

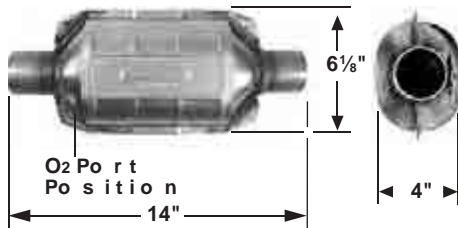

	INLET/I.D.	OUTLET/I.D.
<b>6914</b>	2" Dr. side O <sub>2</sub> Sensor port	2"

#### Round - w/O<sub>2</sub> port

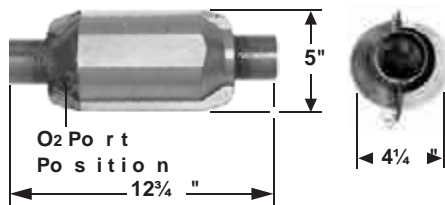

	INLET/I.D.	OUTLET/I.D.
<b>6914R</b>	2" w/Dr. side O <sub>2</sub> Sensor port	2"

#### Spun Body one-piece design

#### Round - w/o Air Tube

#### Pre-OBD II, EPA, 5.9L to 6000 lbs

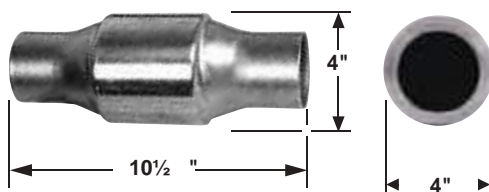

	INLET/I.D.	OUTLET/I.D.
<b>602384</b>	2"	2"
<b>602385</b>	2-1/4"	2-1/4"
<b>602386</b>	2-1/2"	2-1/2"
<b>602387</b>	3"	3"

EPA ONLY - Not for sale or installation in California  
 EPA Solamente - No para Venta o Instalacion en California  
 Seulement EPA - Ne peut pas être vendu et installé en Californie

### 8000 Series

#### HEAVY DUTY

HEAVY DUTY	EPA Eng./Test Weight
2-W AY	7.7L, 7000 lbs
3-W AY	7.5L, 7000 lbs

#### Oval - w/o Air Tube

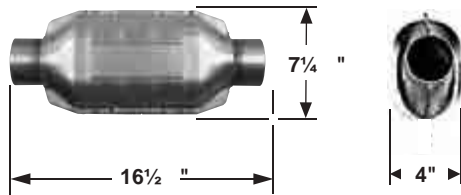

	INLET/I.D.	OUTLET/I.D.
<b>8005</b>	2-1/4"	2-1/4"
<b>8006</b>	2-1/2"	2-1/2"
<b>8007</b>	3"	3"

#### Oval - w/o Air Tube

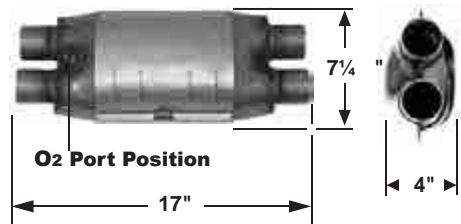

	INLET/I.D.	OUTLET/I.D.
<b>8015</b>	2" Dual Inlets, O2 Sensor port	2" Dual Outlets

### 9000 Series

#### HEAVY DUTY

HEAVY DUTY	EPA Eng./Test Weight
2-W AY	7.7L, 7000 lbs
3-W AY	7.5L, 7000 lbs
3-W AY, w/Air	7.5L, 7000 lbs

#### Oval - w/Air Tube

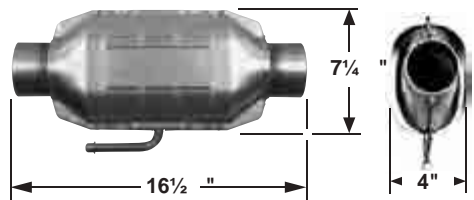

	INLET/I.D.	OUTLET/I.D.
<b>9004</b>	2"	2"
<b>9005</b>	2-1/4"	2-1/4"
<b>9006</b>	2-1/2"	2-1/2"
<b>9007</b>	3"	3"

#### Oval - w/Air Tube

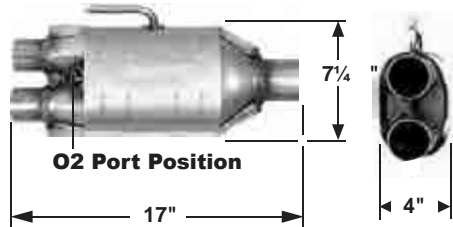

	INLET/I.D.	OUTLET/I.D.
<b>9513</b>	2" Dual, w/O2 Sensor port	2-1/2"

## GENERAL INFORMATION

INFORMACIÓ N GENERAL | INFORMATIONS GÉ NÉ RAL ES

### UNIVERSAL CONVERTER SPECIFICATIONS

### 10000 Series

#### SUPER DUTY

#### Oval - w/Air Tube

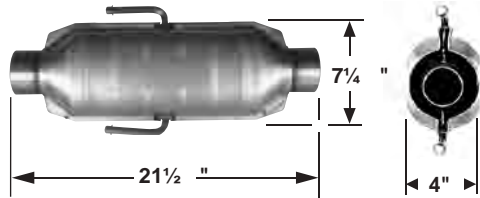

SUPER DUTY	EPA Eng./GV W R
2-W AY	7,55,000 lbs or less
3-W AY	7,55,000 lbs or less
3-W AY , w/Air	7.5L, 15,000 lbs or less

	INLET/I.D.	OUTLET/I.D.
<b>10005</b>	2-1/4"	2-1/4" w/Dual air tubes
<b>10006</b>	2-1/2"	2-1/2" w/Dual air tubes
<b>10007</b>	3"	3" w/Dual air tubes

### 10900 Series

#### SUPER DUTY

#### Oval - w/o Air Tube

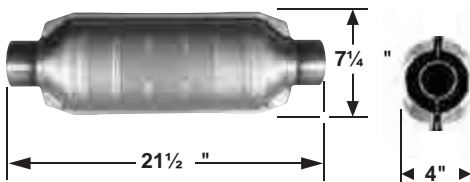

SUPER DUTY	EPA Eng./GV W R
2-W AY	7,55,000 lbs or less
3-W AY	7,55,000 lbs or less

	INLET/I.D.	OUTLET/I.D.
<b>10905</b>	2-1/4"	2-1/4" w/o air tube
<b>10906</b>	2-1/2"	2-1/2" w/o air tube
<b>10907</b>	3"	3" w/o air tube

YR/YRS	CYL	LITER	DESCRIPTION	DIRECT FIT	UNIVERSAL
<b>ACURA CL</b>					
1997	4	2.2L		4355 ③	2564R③
97-99	6	3.0L	Federal Emissions	4253 ④	2565R④
97-99	6	3.0L	California Emissions	4233 ⑤	2505⑤
01-03	6	3.2L	Federal Emissions, Exc. Type S	4209 ④	2565R④
01-03	6	3.2L	Type-S	--	2565R③
<b>ACURA EL</b>					
01-03	4	1.7L	(Canada Model)	4230 ③	--
<b>ACURA INTEGRA</b>					
88-89	4	1.6L		4178 ③	6904R③
86-87	4	1.6L	w/Air Tube	--	6004③
86-87	4	1.6L	w/o Air Tube	4172 ③	6904R③
92-93	4	1.7L		4511 ③	6904R③
00-01	4	1.8L	(Exc. VTEC Eng.)	--	2564R③
00-01	4	1.8L	VTEC	--	2565R③
00-01	4	1.8L	Type-R	--	2565R③
96-99	4	1.8L	Manual Trans., (Exc. GSR Models)	--	2564R③
96-99	4	1.8L	GSR Models	4974 ③	2504③
96-99	4	1.8L	Auto Trans., (Exc. GSR Models)	4361 ③	2564R③
94-95	4	1.8L	3 Dr., (Exc. DOHC-VTEC Eng.)	4511 ③	6904R③
92-93	4	1.8L		4511 ③	6904R③
90-91	4	1.8L		4512 ③	6904R③
<b>ACURA LEGEND</b>					
86-87	6	2.5L		--	6904R③
87-90	6	2.7L		--	6904R③
94-95	6	3.2L	GS Sedan, Front Left	--	2224③
94-95	6	3.2L	GS Sedan, Main Conv.	4879 ③	6906R③
94-95	6	3.2L	GS Sedan, Front Right	--	2224③
93-95	6	3.2L	Coupe L or LS Models, Front Left	--	2224③
93-95	6	3.2L	Coupe L or LS Models, Main Conv.	4879 ③	6906R③
93-95	6	3.2L	Coupe L or LS Models, Front Right	--	2224③
91-92	6	3.2L		4879 ③	6906R③
<b>ACURA MDX</b>					
03-06	6	3.5L	Front Left	1250 ③	--
			Front Left	1155 ③①	--
03-06	6	3.5L	Front Right	1251 ③	--
			Front Right	1156 ③①	--
03-06	6	3.5L	Rear Main	4533 ③	2575R③①
01-02	6	3.5L		4449 ③	2565R③
07-09	6	3.7L	Front Left	1250 ③	--
			Front Left	1155 ③①	--
07-09	6	3.7L	Front Right	1251 ③	--
			Front Right	1156 ③①	--
<b>ACURA NSX</b>					
04-05	6	3.0L	Right Side	--	2572R③
95-03	6	3.0L	Right	--	2565R③
95-03	6	3.0L	Left	--	2565R③
91-94	6	3.0L	Right	--	6905R③

① Discontinued, use until inventory is depleted.

③ Federal & California Emissions. Not For Sale or Use on vehicles licensed in the state of CA & NY (NY vehicles with CA Emissions). Check with your state authority for details.

④ Federal Emissions. Not For Sale or Use on vehicles licensed in the state of CA. Check with your state authority.

⑤ California Emissions. Not For Sale or Use on vehicles licensed in the state of CA & NY. Check with your state authority.

# APPLICATION LISTINGS

## FEDERAL CONVERTERS



YR/YRS	CYL	LITER	DESCRIPTION	DIRECT FIT	UNIVERSAL
<b>ACURA NSX (Cont.)</b>					
91-94	6	3.0L	Left	--	6905R <sup>③</sup>
04-05	6	3.2L	Right Side	--	2572R <sup>③</sup>
97-03	6	3.2L	Right	--	2565R <sup>③</sup>
97-03	6	3.2L	Left	--	2565R <sup>③</sup>
<b>ACURA RDX</b>					
07-12	4	2.3L	Rear	5128 <sup>③</sup>	--
13-14	6	3.5L	Front Left	1222 <sup>③</sup>	--
13-14	6	3.5L	Front Right	1310 <sup>③</sup>	--
13-14	6	3.5L	Rear	4010 <sup>③</sup>	2545 <sup>③</sup>
<b>ACURA RL</b>					
05-08	6	3.5L	Main Conv.	--	2572R <sup>③</sup>
96-04	6	3.5L		4130 <sup>③</sup>	--
2009	6	3.7L	Rear	4010 <sup>③</sup>	2545 <sup>③</sup>
2009	6	3.7L	Front Left	1222 <sup>③</sup>	--
2009	6	3.7L	Front Right	1310 <sup>③</sup>	--
<b>ACURA RSX</b>					
05-06	4	2.0L		--	2565R <sup>③</sup>
02-04	4	2.0L	Type-S	4776 <sup>③</sup>	2565R <sup>③</sup>
02-04	4	2.0L	(Exc. Type S)	4494 <sup>③</sup>	2564R <sup>③</sup>
<b>ACURA SLX</b>					
98-99	6	3.5L	Left	5010 <sup>③</sup>	2564R <sup>③</sup>
<b>ACURA TL</b>					
97-98	5	2.5L	Sedan, Front	--	2555 <sup>③</sup>
95-98	5	2.5L	Rear Main Conv.	4504 <sup>③</sup>	2564R <sup>③</sup>
04-08	6	3.2L	Front Left	1250 <sup>③</sup>	--
			Front Left	1155 <sup>③①</sup>	--
04-08	6	3.2L	Front Right	1251 <sup>③</sup>	--
			Front Right	1156 <sup>③①</sup>	--
04-08	6	3.2L	Rear Main	4533 <sup>③</sup>	2575R <sup>③①</sup>
00-03	6	3.2L	Federal Emissions, Exc. Type S	4209 <sup>④</sup>	2565R <sup>④</sup>
1999	6	3.2L	Federal Emissions	4253 <sup>④</sup>	2565R <sup>④</sup>
1999	6	3.2L	California Emissions	4233 <sup>⑤</sup>	2505 <sup>⑤</sup>
96-98	6	3.2L	w/o Resonator	5154 <sup>③</sup>	--
96-98	6	3.2L	w/Resonator	4130 <sup>③</sup>	--
09-14	6	3.5L	Front Right	1310 <sup>③</sup>	--
09-14	6	3.5L	Front Left	1222 <sup>③</sup>	--
09-14	6	3.5L	Rear	4010 <sup>③</sup>	2545 <sup>③</sup>
07-08	6	3.5L	Front Left	1250 <sup>③</sup>	--
			Front Left	1155 <sup>③①</sup>	--
07-08	6	3.5L	Front Right	1251 <sup>③</sup>	--
			Front Right	1156 <sup>③①</sup>	--
07-08	6	3.5L	Main Conv.	--	2572R <sup>③</sup>
09-14	6	3.7L	Rear	4010 <sup>③</sup>	2545 <sup>③</sup>
09-14	6	3.7L	Front Left	1222 <sup>③</sup>	--
09-14	6	3.7L	Front Right	1310 <sup>③</sup>	--

- ① Discontinued, use until inventory is depleted.
- ③ Federal & California Emissions. Not For Sale or Use on vehicles licensed in the state of CA & NY (NY vehicles with CA Emissions). Check with your state authority for details.
- ④ Federal Emissions. Not For Sale or Use on vehicles licensed in the state of CA. Check with your state authority.
- ⑤ California Emissions. Not For Sale or Use on vehicles licensed in the state of CA & NY. Check with your state authority.
- EPA Enhanced OBDII By Design Unit



YR/YRS	CYL	LITER	DESCRIPTION	DIRECT FIT	UNIVERSAL
<b>ACURA TSX</b>					
09-12	4	2.4L	Front	1174 ③	--
09-12	4	2.4L	Rear Conv.	4774 ③	2576R③
2009	4	2.4L	Main Conv.	--	2565R③
04-08	4	2.4L		4687 ③	2565R③
10-14	6	3.5L	Rear	4010 ③	2545③
10-14	6	3.5L	Front Left	1222 ③	--
10-14	6	3.5L	Front Right	1310 ③	--
<b>ACURA VIGOR</b>					
92-94	5	2.5L	Auto Trans.	--	6904R③
92-94	5	2.5L	Manual Trans.	--	6904R③
<b>ACURA ZDX</b>					
10-13	6	3.7L	Rear	4010 ③	2545③
10-13	6	3.7L	Front Right	1310 ③	--
10-13	6	3.7L	Front Left	1222 ③	--
<b>ALFA ROMEO 164</b>					
91-95	6	3.0L		--	2904③
<b>ALFA ROMEO ALFETTA</b>					
75-77	4	2.0L		--	6904③
<b>ALFA ROMEO MILANO</b>					
87-89	6	2.5L		--	2904③
88-89	6	3.0L		--	2904③
<b>ALFA ROMEO SPIDER</b>					
92-94	4	2.0L		--	6904③
75-81	4	2.0L		--	6903③
<b>AMERICAN MOTORS AMX</b>					
78-79	6,8	All		--	6004③
<b>AMERICAN MOTORS CONCORD</b>					
78-79	4	2.0L		--	6004③
80-82	4	All		--	6004③
80-83	6	4.2L	w/Air Tube	--	6004③
80-83	6	4.2L	w/o Air Tube	--	6904③
78-79	6,8	All		--	6004③
<b>AMERICAN MOTORS EAGLE, SX4</b>					
1984	4	2.5L		--	6004③
81-83	4	2.5L		--	6004③
85-88	6	4.2L	w/Air Tube	--	6004③
82-84	6	4.2L		--	6004③
80-81	6	4.2L		--	6004③
<b>AMERICAN MOTORS GREMLIN</b>					
75-76	8	5.0L		--	6004③
1978	4,6	2.0L, 3.8L,		--	6004③
75-77	4,6	3.8L, 4.2L		--	6004③
<b>AMERICAN MOTORS HORNET</b>					
75-77	6,8	All		--	6004③
<b>AMERICAN MOTORS MATADOR</b>					
1978	6	All		--	6004③
75-76	8	6.6L	401 C.I.D.	--	9004③
75-77	6,8	All	(Exc. 401 C.I.D.)	--	6004③

③ Federal & California Emissions. Not For Sale or Use on vehicles licensed in the state of CA & NY (NY vehicles with CA Emissions). Check with your state authority for details.

**APPLICATION LISTINGS  
FEDERAL CONVERTERS**



YR/YRS	CYL	LITER	DESCRIPTION	DIRECT FIT	UNIVERSAL
<b>AMERICAN MOTORS PACER</b>					
75-79	6	All		--	6004 <sup>③</sup>
<b>AMERICAN MOTORS SPIRIT</b>					
81-82	4	All		--	6004 <sup>③</sup>
1980	4	All		--	6004 <sup>③</sup>
79-83	6	All		--	6004 <sup>③</sup>
1979	8	All		--	6004 <sup>③</sup>
<b>ASTON MARTIN LAGONDA</b>					
85-89	V8	5.3L		--	2905 <sup>③</sup>
<b>ASTON MARTIN V-8</b>					
85-89	V8	5.3L		--	2905 <sup>③</sup>
<b>ASTON MARTIN ZAGATO</b>					
87-88	V8	5.3L		--	2905 <sup>③</sup>
<b>ASTON MARTIN VIRAGE</b>					
89-90	V8	5.3L		--	2905 <sup>③</sup>
<b>ASUNA GT</b>					
1993	4	All	GT Models	--	6906 <sup>③</sup>
<b>ASUNA SE</b>					
1993	4	All	SE Models	--	6906 <sup>③</sup>
<b>ASUNA SUNFIRE</b>					
92-93	4	1.8L	Sunfire	--	6906 <sup>③</sup>
<b>ASUNA SUNRUNNER</b>					
94-95	4	1.6L	w/21" Conv. (Canada Model)	--	6904 <sup>③</sup>
89-93	4	All	(Canada Model)	4467 <sup>③</sup>	6905 <sup>③</sup>
<b>AUDI 100</b>					
75-77	4	1.9L		--	6904R <sup>③</sup>
89-91	5	2.3L	Auto Trans., (Exc. Quattro); From 8/89	--	6905R <sup>③</sup>
89-91	5	2.3L	Manual Trans., (Exc. Quattro); From 8/89	--	6905R <sup>③</sup>
89-91	5	2.3L	Quattro; From 5/88 To 12/90	--	6904R <sup>③</sup>
93-94	6	2.8L	Manual Trans., Left	--	6905 <sup>③</sup>
93-94	6	2.8L	Manual Trans., Right	--	6905 <sup>③</sup>
93-94	6	2.8L	S, CS Sedan & S Wagon w/Auto Trans., Right Side	4036 <sup>③</sup>	6905 <sup>③</sup>
93-94	6	2.8L	S, CS Sedan & S Wagon w/Auto Trans., Left Side	4037 <sup>③</sup>	6905 <sup>③</sup>
92-93	6	2.8L	Quattro, Right Side	4036 <sup>③</sup>	6905 <sup>③</sup>
92-93	6	2.8L	Quattro, Left Side	4037 <sup>③</sup>	6905 <sup>③</sup>
1992	6	2.8L	Manual Trans., Right, (Exc. Quattro)	--	6905 <sup>③</sup>
1992	6	2.8L	Manual Trans., Left, (Exc. Quattro)	--	6905 <sup>③</sup>
<b>AUDI 200</b>					
90-91	5	2.2L	Quattro	--	6905 <sup>③</sup>
89-91	5	2.2L	Auto Trans., (Exc. Quattro)	--	6906R <sup>③</sup>
<b>AUDI 4000</b>					
1980	4	1.6L		--	6904R <sup>③</sup>
81-83	4	1.7L	w/Conv.	--	6904R <sup>③</sup>
84-87	4	1.8L		--	6904R <sup>③</sup>
85-86	5	2.2L	(Exc. Quattro)	--	6904R <sup>③</sup>
<b>AUDI 5000</b>					
86-88	5	2.2L	Auto Trans., (Exc. Quattro)	--	6906R <sup>③</sup>
86-88	5	2.2L	Manual Trans., (Exc. Quattro)	--	6905R <sup>③</sup>
81-85	5	2.2L	(Exc. Turbo or Quattro); To 12/84	--	6904R <sup>③</sup>

③ Federal & California Emissions. Not For Sale or Use on vehicles licensed in the state of CA & NY (NY vehicles with CA Emissions). Check with your state authority for details.

YR/YRS	CYL	LITER	DESCRIPTION	DIRECT FIT	UNIVERSAL
<b>AUDI 5000 (Cont.)</b>					
87-88	5	2.3L	Auto Trans., (Exc. Quattro)	--	6906R <sup>③</sup>
87-88	5	2.3L	Manual Trans., (Exc. Quattro)	--	6905R <sup>③</sup>
81-85	5	All	Turbo, (Exc. Quattro)	--	6906R <sup>③</sup>
1980	5	All	California Emissions, w/Turbo	--	6906R <sup>⑤</sup>
1980	5	All	California Emissions, (Exc. Turbo)	--	6904R <sup>⑤</sup>
1980	5	All	Federal Emissions	--	6905R <sup>④</sup>
78-79	5	All		--	6905R <sup>③</sup>
<b>AUDI 80</b>					
88-90	4	2.0L	Auto Trans.	--	6904R <sup>③</sup>
88-90	4	2.0L	Manual Trans.	--	6904R <sup>③</sup>
91-92	5	2.3L	(Exc. Quattro)	--	6904R <sup>③</sup>
88-91	5	All	Quattro; From 10/87 To 9/91	--	6904R <sup>③</sup>
<b>AUDI 90 (Exc. Cabriolet)</b>					
1988	4	2.0L	Auto Trans.	--	6904R <sup>③</sup>
1988	4	2.0L	Manual Trans.	--	6905R <sup>③</sup>
90-91	5	2.3L	4 Speed Auto Trans., (Exc. Quattro)	--	6905R <sup>③</sup>
88-91	5	2.3L	Manual Trans., (Exc. Quattro)	--	6905R <sup>③</sup>
88-91	5	All	Quattro or 3 Speed Auto Trans.	--	6905R <sup>③</sup>
93-95	6	2.8L	Auto Trans., Right Side	--	6905R <sup>③</sup>
93-95	6	2.8L	Auto Trans., Left Side	--	6905R <sup>③</sup>
93-95	6	2.8L	Manual Trans., Right	--	6904R <sup>③</sup>
93-95	6	2.8L	Manual Trans., Left	--	6904R <sup>③</sup>
<b>AUDI A3</b>					
06-08	4	2.0L		4912 <sup>③</sup>	--
<b>AUDI A3 QUATTRO</b>					
06-09	6	3.2L		5045 <sup>③</sup>	--
<b>AUDI A4</b>					
97-06	4	1.8L	Turbo	4186 <sup>③</sup>	2504R <sup>③</sup>
97-05	4	1.8L	Quattro, Turbo	4186 <sup>③</sup>	2504R <sup>③</sup>
2009	4	2.0L	A4 & A4 Quattro, Cabriolet Submodels	4645 <sup>③</sup>	--
05-08	4	2.0L	A4 & A4 Quattro	4645 <sup>③</sup>	--
2001	6	2.8L	Quattro, Right Side, w/ Man. Trans.	4660 <sup>③</sup>	--
2001	6	2.8L	Quattro, Left Side, w/ Man. Trans.	4661 <sup>③</sup>	--
00-01	6	2.8L	Quattro, Automatic Trans., Right	5053 <sup>③</sup>	--
00-01	6	2.8L	Quattro, Automatic Trans., Left	5052 <sup>③</sup>	--
98-99	6	2.8L	Quattro, Right	4374 <sup>③</sup>	2564 <sup>③</sup>
98-99	6	2.8L	Quattro, Left	4375 <sup>③</sup>	2564 <sup>③</sup>
98-99	6	2.8L	Auto Trans., Right Side	4374 <sup>③</sup>	2564 <sup>③</sup>
98-99	6	2.8L	Auto Trans., Left Side	4375 <sup>③</sup>	2564 <sup>③</sup>
1997	6	2.8L	AHA Engine, Auto. Trans., Right	4374 <sup>③</sup>	2564 <sup>③</sup>
1997	6	2.8L	AHA Engine, Auto. Trans., Left	4375 <sup>③</sup>	2564 <sup>③</sup>
1996	6	2.8L	Right	--	2504R <sup>③</sup>
1996	6	2.8L	Left	--	2504R <sup>③</sup>
02-05	6	3.0L	Quattro, Left Side, w/ Man. Trans.	5101 <sup>③</sup>	--
02-05	6	3.0L	Quattro, Right Side, w/ Man. Trans.	5102 <sup>③</sup>	--
03-04	6	3.0L	Cabriolet, Right	4458 <sup>③</sup>	--
03-04	6	3.0L	Cabriolet, Left	4459 <sup>③</sup>	--

③ Federal & California Emissions. Not For Sale or Use on vehicles licensed in the state of CA & NY (NY vehicles with CA Emissions). Check with your state authority for details.

④ Federal Emissions. Not For Sale or Use on vehicles licensed in the state of CA. Check with your state authority.

⑤ California Emissions. Not For Sale or Use on vehicles licensed in the state of CA & NY. Check with your state authority.

# APPLICATION LISTINGS

## FEDERAL CONVERTERS



YR/YRS	CYL	LITER	DESCRIPTION	DIRECT FIT	UNIVERSAL
<b>AUDI A4 (Cont.)</b>					
02-04	6	3.0L	Sedan, 5 Speed Auto. Trans., Right	4458 ③	--
02-04	6	3.0L	Sedan, 5 Speed Auto. Trans., Left	4459 ③	--
07-08	6	3.2L	Right	--	2565R③
07-08	6	3.2L	Left	--	2565R③
<b>AUDI A6</b>					
03-04	6	2.7L	Left	--	2565R③
03-04	6	2.7L	Quattro, Automatic Trans., Right	5199 ③	--
03-04	6	2.7L	Quattro, Automatic Trans., Left	5198 ③	--
03-04	6	2.7L	Right	--	2565R③
00-04	6	2.7L	Quattro, Standard Trans., Right	5184 ③	--
00-04	6	2.7L	Quattro, Standard Trans., Left	5183 ③	--
00-02	6	2.7L	Turbo Quattro w/Auto Trans., Right Side	4206 ③	2504R③
00-02	6	2.7L	Turbo Quattro w/Auto Trans., Left Side	4207 ③	2504R③
00-01	6	2.8L	Quattro Sedan & Wagon w/Auto Trans., Right Side	4240 ③	2504R③
00-01	6	2.8L	Quattro Sedan & Wagon w/Auto Trans., Left Side	4241 ③	2504R③
98-99	6	2.8L	AHA Engine, Right	4374 ③	--
98-99	6	2.8L	AHA Engine, Left	4439 ③	--
98-99	6	2.8L	Quattro Sedan & Wagon, AHA Engine, Right Side	4374 ③	--
98-99	6	2.8L	Quattro Sedan & Wagon, AHA Engine, Left Side	4439 ③	--
95-97	6	2.8L	Left	--	2504R③
95-97	6	2.8L	Right	--	2504R③
2003	6	3.0L	Quattro, Right Side, w/ Auto. Trans.	4654 ③	2565R③
2003	6	3.0L	Quattro, Left Side, w/ Auto. Trans.	4655 ③	2565R③
06-08	6	3.2L	Left	--	2565R③
06-08	6	3.2L	Right	--	2565R③
05-08	6	3.2L	Quattro, Left	5066 ③	--
05-08	6	3.2L	Quattro, Right	5067 ③	--
03-04	8	4.2L	Left	--	2565R③
03-04	8	4.2L	Right	--	2565R③
00-01	8	4.2L	Quattro Sedan & Wagon w/Auto Trans., Right Side	4240 ③	2504R③
00-01	8	4.2L	Quattro Sedan & Wagon w/Auto Trans., Left Side	4241 ③	2504R③
<b>AUDI ALL ROAD</b>					
03-05	6	2.7L	Right	--	2565R③
03-05	6	2.7L	Left	--	2565R③
01-02	6	2.7L	Turbo Quattro, w/Auto Trans, Right Side	4206 ③	2504R③
01-02	6	2.7L	Turbo Quattro, w/Auto Trans, Left Side	4207 ③	2504R③
01-02	6	2.7L	Manual Trans., Right	--	2565R③
01-02	6	2.7L	Manual Trans., Left	--	2565R③
<b>AUDI ALLROAD QUATTRO</b>					
03-05	6	2.7L	Automatic Trans., Left	5198 ③	--
03-05	6	2.7L	Automatic Trans., Right	5199 ③	--
01-05	6	2.7L	Quattro, Standard Trans., Right	5184 ③	--
01-05	6	2.7L	Quattro, Standard Trans., Left	5183 ③	--
03-05	8	4.2L	Automatic Trans., Left	5062 ③	--
03-05	8	4.2L	Automatic Trans., Right	5063 ③	--

③ Federal & California Emissions. Not For Sale or Use on vehicles licensed in the state of CA & NY (NY vehicles with CA Emissions). Check with your state authority for details.

YR/YRS	CYL	LITER	DESCRIPTION	DIRECT FIT	UNIVERSAL
<b>AUDI CABRIOLET</b>					
96-98	6	2.8L	AFC Eng., Left	--	2504R③
96-98	6	2.8L	AFC Eng., Right	--	2504R③
96-97	6	2.8L	AAH & AFC Eng., Right	--	2504R③
96-97	6	2.8L	AAH & AFC Eng., Left	--	2504R③
94-95	6	2.8L	AAH & AFC Eng., Right	--	6904R③
94-95	6	2.8L	AAH & AFC Eng., Left	--	6904R③
<b>AUDI COUPE</b>					
81-85	5	2.2L	Quattro	--	6904R③
<b>AUDI FOX</b>					
75-79	4	1.6L		--	6904R③
<b>AUDI Q7</b>					
2007	6	3.6L	Left	5180 ③	--
2007	6	3.6L	Right	5181 ③	--
<b>AUDI S4</b>					
92-94	5	2.2L		--	6904R③
04-09	8	4.2L	Standard Trans., Left	5191 ③	--
04-09	8	4.2L	Standard Trans., Right	5192 ③	--
<b>AUDI S6</b>					
1995	5	2.2L	Right	--	2504R③
1995	5	2.2L	Left	--	2504R③
<b>AUDI TT</b>					
03-06	4	1.8L	AWD Quattro, Eng. Code-BEA	4258 ③	--
00-06	4	1.8L	(Exc. Quattro)	4158 ③	--
01-02	4	1.8L	AWD Quattro, Eng. Code-AMU	4258 ③	--
04-06	6	3.2L	Quattro	5164 ③	--
<b>AUDI V-8</b>					
90-91	8	3.6L		--	6905R③
92-94	8	4.2L		--	6905R③
<b>AVANTI II</b>					
84-85	V8	5.0L	w/Air Tube	--	2906③
81-85	V8	5.0L	w/o Air Tube	--	6905③
77-80	V8	5.7L		--	6005③
75-76	V8	6.6L		--	9005③
<b>BERTONE X-1/9</b>					
84-89	4	1.5L	17-3/4" Conv	--	6903③
84-85	4	2.0L	17-3/4" Conv	--	6903③
84-89	4	All	(Exc. 17-3/4" Conv.)	--	6903③
<b>BLUE BIRD BUS CV200</b>					
98-00	8	7.4L	Built on GMC Chassis	10921 ③	10907③
<b>BMW 318</b>					
1995	4	1.8L		--	2904③
91-94	4	1.8L		9068 ③	2904③
84-85	4	1.8L		--	2904③
96-98	4	1.9L	318I, IS, IC, (E36 Models)	4078 ③	2540③
1996	4	1.9L	318 TI, (E36 Models)	4078 ③	2540③
<b>BMW 320</b>					
80-83	4	1.8L	From 9/79	--	2904③
77-79	4	All	California Emissions	--	2904⑤

③ Federal & California Emissions. Not For Sale or Use on vehicles licensed in the state of CA & NY (NY vehicles with CA Emissions). Check with your state authority for details.

⑤ California Emissions. Not For Sale or Use on vehicles licensed in the state of CA & NY. Check with your state authority.

**APPLICATION LISTINGS**  
**FEDERAL CONVERTERS**



YR/YRS	CYL	LITER	DESCRIPTION	DIRECT FIT	UNIVERSAL
<b>BMW 323CI</b>					
2000	6	2.5L	Manifold Unit, Front	4801 ③	--
2000	6	2.5L	Rear Manifold Conv.	4800 ③	--
<b>BMW 323I</b>					
99-00	6	2.5L	Manifold Unit, Front	4801 ③	--
99-00	6	2.5L	Rear Manifold Conv.	4800 ③	--
<b>BMW 325</b>					
01-06	6	2.5L	325ci, Exc. SULEV Emissions, Front	4386 ③	--
01-06	6	2.5L	325ci, Exc. SULEV Emissions, Rear	4387 ③	--
01-05	6	2.5L	325i, 325xi, Exc. SULEV Emissions, Front	4386 ③	--
01-05	6	2.5L	325i, 325xi, Exc. SULEV Emissions, Rear	4387 ③	--
1995	6	2.5L	325i iC iS E/36, Right	--	6904R ③
1995	6	2.5L	325i iC iS E/36, Left	--	6904R ③
92-95	6	2.5L	325i iC iS	9615 ③	--
88-91	6	2.5L	325 Models, (Exc. iC)	--	2910 ③
87-91	6	2.5L	325 iC ; From 9/86	--	2910 ③
84-87	6	2.7L	325, 325E, 325ES	--	2904 ③
2006	6	3.0L	325i, Rear Left	5162 ③	--
2006	6	3.0L	325xi, Rear Left	5162 ③	--
2006	6	3.0L	325i, Rear Right	5163 ③	--
2006	6	3.0L	325xi, Rear Right	5163 ③	--
<b>BMW 328</b>					
2000	6	2.8L	328ci, Front Manifold Conv.	4801 ③	--
2000	6	2.8L	328ci, Rear Manifold Conv.	4800 ③	--
99-00	6	2.8L	328i, Front Manifold Conv.	4801 ③	--
99-00	6	2.8L	328i, Rear Manifold Conv.	4800 ③	--
96-98	6	2.8L	328i, iS, Convertible	9615 ③	--
96-97	6	2.8L	328 E/36, Right	--	2504R ③
96-97	6	2.8L	328 E/36, Left	--	2504R ③
07-12	6	3.0L	328i, ULEV Emissions, Rear Left	5162 ③	--
07-12	6	3.0L	328i, ULEV Emissions, Rear Right	5163 ③	--
07-08	6	3.0L	328xi, ULEV Emissions, Rear Left	5162 ③	--
07-08	6	3.0L	328xi, ULEV Emissions, Rear Right	5163 ③	--
<b>BMW 330</b>					
2006	6	3.0L	330i, Rear Manifold Converter	4559 ③	--
2006	6	3.0L	330ci, Rear Left	5162 ③	--
2006	6	3.0L	330xi, Rear Left	5162 ③	--
2006	6	3.0L	330ci, Rear Right	5163 ③	--
2006	6	3.0L	330xi, Rear Right	5163 ③	--
04-06	6	3.0L	330ci, Exc. SULEV Emissions, Front	4558 ③	--
04-06	6	3.0L	330ci, Exc. SULEV Emissions, Rear	4559 ③	--
01-06	6	3.0L	330xi, Front Manifold Converter	4558 ③	--
01-06	6	3.0L	330xi, Rear Manifold Converter	4559 ③	--
01-05	6	3.0L	330i, Exc. SULEV Emissions, Front	4386 ③	--
01-05	6	3.0L	330i, Exc. SULEV Emissions, Rear	4387 ③	--
01-03	6	3.0L	330ci, Exc. SULEV Emissions, Front	4386 ③	--
01-03	6	3.0L	330ci, Exc. SULEV Emissions, Rear	4387 ③	--

③ Federal & California Emissions. Not For Sale or Use on vehicles licensed in the state of CA & NY (NY vehicles with CA Emissions). Check with your state authority for details.

YR/YRS	CYL	LITER	DESCRIPTION	DIRECT FIT	UNIVERSAL
<b>BMW 525</b>					
04-05	6	2.5L	525i, Manifold Unit, Front	1337 ③	--
04-05	6	2.5L	525i, Manifold Unit, Rear	1338 ③	--
01-03	6	2.5L	Manifold Unit, Rear	1294 ③	--
01-03	6	2.5L	Manifold Unit, Front	1293 ③	--
91-95	6	2.5L	525i, 24 valve E/34; To 3/95	--	2915③
89-90	6	2.5L		--	2912③
06-07	6	3.0L	525i & 525Xi, Front Manifold Converter	4707 ③	--
06-07	6	3.0L	525i & 525Xi, Rear Manifold Converter	4706 ③	--
06-07	6	3.0L	525i & 525Xi, Right Rear	4708 ③	--
06-07	6	3.0L	525i & 525Xi, Left Rear	4709 ③	--
<b>BMW 528</b>					
87-88	6	2.7L	528E; From 3/87	--	2912③
82-87	6	2.7L	528E ; To 2/87	--	2908③
99-00	6	2.8L	528i, Front Manifold Conv.	4801 ③	--
99-00	6	2.8L	528i, Rear Manifold Conv.	4802 ③	--
97-99	6	2.8L	528i, Right	--	2504R③
97-99	6	2.8L	528i, Left	--	2504R③
79-81	6	All	528i	--	2910③
<b>BMW 530</b>					
06-07	6	3.0L	530i & 530Xi, Front Manifold Converter	4707 ③	--
06-07	6	3.0L	530i & 530Xi, Rear Manifold Converter	4706 ③	--
06-07	6	3.0L	530i & 530Xi, Right Rear	4708 ③	--
06-07	6	3.0L	530i & 530Xi, Left Rear	4709 ③	--
04-05	6	3.0L	530i, Manifold Unit, Rear	1338 ③	--
04-05	6	3.0L	530i, Manifold Unit, Front	1337 ③	--
01-03	6	3.0L	Manifold Unit, Rear	1294 ③	--
01-03	6	3.0L	Manifold Unit, Front	1293 ③	--
1994	8	All	530, Right	--	6904R③
1994	8	All	530, Left	--	6904R③
<b>BMW 533</b>					
83-84	6	All		--	2910③
<b>BMW 535</b>					
88-93	6	3.5L	535i; From 6/88	--	8015③
85-88	6	3.5L	To 5/88	--	2912③
88-93	6	All	California Emissions, Main Conv.; From 6/88	--	2912⑤
<b>BMW 540</b>					
1994	8	4.0L	540i, Right Side	--	2904③
1994	8	4.0L	540i, Left Side	--	2904③
99-03	8	4.4L	Rear Right	5041 ③	--
99-03	8	4.4L	Rear Left	5040 ③	--
97-98	8	4.4L	Left	4407 ③	2540③
97-98	8	4.4L	Right	4406 ③	2540③
<b>BMW 550I</b>					
2011	8	4.4L	Front Left	1327 ③	--
2011	8	4.4L	Front Right	1328 ③	--
<b>BMW 550I GT</b>					
10-11	8	4.4L	Front Left	1327 ③	--
10-11	8	4.4L	Front Right	1328 ③	--

③ Federal & California Emissions. Not For Sale or Use on vehicles licensed in the state of CA & NY (NY vehicles with CA Emissions). Check with your state authority for details.

⑤ California Emissions. Not For Sale or Use on vehicles licensed in the state of CA & NY. Check with your state authority.

**APPLICATION LISTINGS  
FEDERAL CONVERTERS**



YR/YRS	CYL	LITER	DESCRIPTION	DIRECT FIT	UNIVERSAL
<b>BMW 550I GT XDRIVE</b>					
10-11	8	4.4L	Front Left	1327 ③	--
10-11	8	4.4L	Front Right	1328 ③	--
<b>BMW 550I XDRIVE</b>					
2011	8	4.4L	Front Left	1327 ③	--
2011	8	4.4L	Front Right	1328 ③	--
<b>BMW 633</b>					
82-84	6	3.2L	633 CSI ; From 9/81 To 8/84	--	2910③
79-81	6	3.2L	633 CSI ; From 9/79 To 8/81	--	2908③
<b>BMW 635</b>					
88-89	6	3.5L	635 CSI	--	2912③
85-87	6	3.5L	635 CSI ; From 9/84 To 8/87	--	2912③
<b>BMW 650I</b>					
2012	8	4.4L	Front Left	1327 ③	--
2012	8	4.4L	Front Right	1328 ③	--
<b>BMW 650I XDRIVE</b>					
2012	8	4.4L	Front Left	1327 ③	--
2012	8	4.4L	Front Right	1328 ③	--
<b>BMW 733</b>					
82-84	6	3.2L		--	2910③
80-81	6	3.2L		--	2912③
<b>BMW 735</b>					
87-92	6	3.5L	735i, iL, E/32	--	2912③
85-87	6	3.5L	735i, E/23; From 9/84	--	2910③
<b>BMW 740</b>					
1995	8	4.0L	Left	--	2504R③
1995	8	4.0L	Right	--	2504R③
1994	8	4.0L	Left	--	2904③
1994	8	4.0L	Right	--	2904③
1993	8	4.0L	740i & 740il Models, Right Side	--	2904③
1993	8	4.0L	740i & 740il Models, Left Side	--	2904③
99-01	8	4.4L	740i, Rear Right	5041 ③	--
99-01	8	4.4L	740i, Rear Left	5040 ③	--
99-01	8	4.4L	740il, Rear Right	5041 ③	--
99-01	8	4.4L	740il, Rear Left	5040 ③	--
97-98	8	4.4L	740i & 740il Models, Right Side	4406 ③	2540③
97-98	8	4.4L	740i & 740il Models, Left Side	4407 ③	2540③
1996	8	4.4L	740il, Right	4406 ③	2540③
1996	8	4.4L	740il, Left	4407 ③	2540③
<b>BMW 745</b>					
02-05	8	4.4L	745Li, Right	--	2564③
<b>BMW 750</b>					
88-94	12	5.0L	E/32, Right; From 12/87	--	2908③
88-94	12	5.0L	E/32, Left; From 12/87	--	2908③
95-96	12	5.4L	E/38, Right	--	2540③
95-96	12	5.4L	E/38, Left	--	2540③
<b>BMW 750I</b>					
09-11	8	4.4L	Front Left	1327 ③	--
09-11	8	4.4L	Front Right	1328 ③	--

③ Federal & California Emissions. Not For Sale or Use on vehicles licensed in the state of CA & NY (NY vehicles with CA Emissions). Check with your state authority for details.



YR/YRS	CYL	LITER	DESCRIPTION	DIRECT FIT	UNIVERSAL
<b>BMW 750I XDRIVE</b>					
10-11	8	4.4L	Front Left	1327 ③	--
10-11	8	4.4L	Front Right	1328 ③	--
<b>BMW 750LI</b>					
10-11	8	4.4L	Front Left	1327 ③	--
10-11	8	4.4L	Front Right	1328 ③	--
<b>BMW 750LI XDRIVE</b>					
10-11	8	4.4L	Front Left	1327 ③	--
10-11	8	4.4L	Front Right	1328 ③	--
<b>BMW 840</b>					
1995	8	4.0L	840 CI, Right	--	2539③
1995	8	4.0L	840 CI, Left	--	2539③
1994	8	4.0L	840 CI, Right	--	2904③
1994	8	4.0L	840 CI, Left	--	2904③
1996	8	4.4L	840 CI, Right	--	2539③
1996	8	4.4L	840 CI, Left	--	2539③
<b>BMW 850</b>					
1994	12	5.0L	850 CI, Right	--	2908③
1994	12	5.0L	850 CI, Left	--	2908③
91-93	12	5.0L	850, Right	--	2908③
91-93	12	5.0L	850, Left	--	2908③
1996	12	5.4L	850 CI, Right	--	2540③
1996	12	5.4L	850 CI, Left	--	2540③
1995	12	5.4L	850 CI, Right	--	2540③
1995	12	5.4L	850 CI, Left	--	2540③
1995	12	5.6L	850 CSI, Right	--	2540③
1995	12	5.6L	850 CSI, Left	--	2540③
1994	12	5.6L	850 CSI, Right	--	2908③
1994	12	5.6L	850 CSI, Left	--	2908③
<b>BMW M3</b>					
88-91	4	2.3L	Right	--	2904③
88-91	4	2.3L	Left	--	2904③
1995	6	3.0L	Right	--	2540③
1995	6	3.0L	Left	--	2540③
96-98	6	3.2L		9615 ③	--
96-97	6	3.2L	Right	--	2540③
96-97	6	3.2L	Left	--	2540③
<b>BMW M5</b>					
1988	6	3.5L	Right	--	2904③
1988	6	3.5L	Left	--	2904③
91-93	6	3.6L	Right	--	2904③
91-93	6	3.6L	Left	--	2904③
<b>BMW M6</b>					
87-88	6	3.5L	Right	--	2904③
87-88	6	3.5L	Left	--	2904③
<b>BMW X5</b>					
01-06	6	3.0L	Manifold Unit, Rear	1294 ③	--
01-06	6	3.0L	Manifold Unit, Front	1293 ③	--
10-11	8	4.4L	Front Left	1327 ③	--

③ Federal & California Emissions. Not For Sale or Use on vehicles licensed in the state of CA & NY (NY vehicles with CA Emissions). Check with your state authority for details.

# APPLICATION LISTINGS

## FEDERAL CONVERTERS



YR/YRS	CYL	LITER	DESCRIPTION	DIRECT FIT	UNIVERSAL
<b>BMW X5 (Cont.)</b>					
10-11	8	4.4L	Front Right	1328 ③	--
00-03	8	4.4L	Right	4474 ③	2564R③
00-03	8	4.4L	Left	4475 ③	2564R③
02-03	8	4.6L	Right	4474 ③	2564R③
<b>BMW X6</b>					
08-11	8	4.4L	Front Left	1327 ③	--
08-11	8	4.4L	Front Right	1328 ③	--
<b>BMW Z3</b>					
96-98	4	1.9L		--	2540③
01-02	6	2.5L	Front Conv.	4386 ③	--
01-02	6	2.5L	Rear Conv.	4387 ③	--
99-00	6	2.5L	Manifold Unit, Front	4801 ③	--
99-00	6	2.5L	Rear Manifold Conv.	4800 ③	--
99-00	6	2.8L	Manifold Unit, Front	4801 ③	--
99-00	6	2.8L	Rear Manifold Conv.	4800 ③	--
01-02	6	3.0L	Front Conv.	4386 ③	--
01-02	6	3.0L	Rear Conv.	4387 ③	--
<b>BMW Z4</b>					
03-05	6	2.5L	Right	--	2565R③
03-06	6	3.0L	Right	--	2565R③
<b>BUICK ALLURE</b>					
2010	6	3.0L	Front, Left	1344 ③	--
2010	6	3.0L	Front Right	1345 ③	--
2010	6	3.0L	FWD, Center	5070 ③	--
<b>BUICK APOLLO</b>					
1975	6,8	All		--	6905③
<b>BUICK CENTURY</b>					
1996	4	2.2L		4789 ③	2505③
93-95	4	2.2L		4789 ③	6904③
86-92	4	2.5L	Conv. w/Front Pipe, w/o Air Tube	4076 ③	6904③
86-92	4	2.5L	Conv. w/o Front Pipe, w/Air Tube	4155 ☆②③	6004③
82-85	4	2.5L		--	6004③
87-89	6	2.8L	Conv. w/Front Pipe	--	6004③
84-89	6	2.8L	Conv. Only	4155 ☆②③	6004③
82-83	6	2.8L		--	6004③
82-85	6	3.0L		--	6004③
97-05	6	3.1L		4850 ③	2505③
1996	6	3.1L		4229 ③	2505③
1995	6	3.1L		4229 ③	2505③
1994	6	3.1L		4229 ③	6905③
1993	6	3.3L	Station Wgn.	--	6905③
89-93	6	3.3L	(Exc. '93 Station Wgn.)	4419 ③	6905③
86-88	6	3.8L	Includes Front Pipe, w/o Air Tube	--	6904③
86-88	6	3.8L	Conv. Only, w/Air Tube	4155 ☆②③	6004③
84-85	6	3.8L		--	6004③
1981	6	3.8L	(Exc. Turbo)	4111 ☆③	6005③
1980	6	3.8L	(Exc. Turbo)	--	6906③

☆ Air Tube kit 4948 may be required for installation.

② When using with aftermarket piping, direct fit converter may require INLET/OUTLET pipe resizing.

③ Federal & California Emissions. Not For Sale or Use on vehicles licensed in the state of CA & NY (NY vehicles with CA Emissions). Check with your state authority for details.

YR/YRS	CYL	LITER	DESCRIPTION	DIRECT FIT	UNIVERSAL
<b>BUICK CENTURY (Cont.)</b>					
79-80	6	3.8L	Turbo	--	6906③
75-77	6	3.8L		--	6906③
78-79	6	All	(Exc. Turbo)	4111 ☆③	6005③
1981	8	4.3L		4111 ☆③	6005③
1979	8	4.9L		--	6005③
1978	8	5.0L	w/2 bbl Carb.	4111 ☆③	6005③
1977	8	6.6L	403 C.I.D.	--	8006③
1980	8	All		--	6006③
78-79	8	All	(Exc. 5.0L w/2 bbl Carb.)	--	6906③
75-77	8	All	(Exc. 403 C.I.D. 6.6L Eng.)	--	6906③
<b>BUICK ELECTRA - (Inc. Park Avenue)</b>					
88-90	6	3.8L	For use with OE intermediate pipe, #6 bushing may be required with aftermarket pipe.	4120 ②③	6905③
88-90	6	3.8L	For use with 2-3/8" I.D. aftermarket intermediate pipe.	4120G ③	6905③
86-87	6	3.8L	For use with OE intermediate pipe.	4501 ②③	6905③
86-87	6	3.8L	For use with 2-3/8" I.D. aftermarket intermediate pipe.	--	6905③
1984	6	4.1L		4112 ☆③	6905③
81-83	6	4.1L		4111 ☆③	6005③
1980	6	4.1L		--	6906③
1985	6	All		--	6004③
1980	8	4.9L		--	6906③
84-89	8	5.0L	Electra Station Wgn.	--	2905③
84-89	8	5.0L	Electra Station Wgn., Optional Direct Fit Converter	4119 ☆③	6005③
1984	8	5.0L	Electra, (Exc. Station Wgn.)	4119 ☆③	6005③
81-83	8	5.0L		4111 ☆③	6005③
1980	8	5.7L	Code "X"	--	6906③
1980	8	5.7L	Code "R"	--	6005③
77-79	8	6.6L	403 C.I.D.	--	9006③
75-76	8	7.5L		--	8006③
77-79	8	All	(Exc. 403 C.I.D.)	--	6906③
<b>BUICK ENCLAVE</b>					
09-12	6	3.6L	Rear Main	4695 ③	--
08-11	6	3.6L	Front Conv.	4572 ③	--
08-11	6	3.6L	Rear Conv.	4573 ③	--
<b>BUICK LACROSSE</b>					
2010	6	3.0L	Front, Left	1344 ③	--
2010	6	3.0L	Front Right	1345 ③	--
2010	6	3.0L	FWD, Center	5070 ③	--
06-08	6	3.6L		--	2575③○
05-09	6	3.8L		4341 ③	2575③○
				--	2538③□
08-09	8	5.3L		4531 ③	--
<b>BUICK LESABRE</b>					
00-05	6	3.8L	(Exc. Supercharged, Use w/OE Pipe, Includes Resonator )	9035 ③	2517③
00-05	6	3.8L		9988 ③	2517③

☆ Air Tube kit 4948 may be required for installation.

② When using with aftermarket piping, direct fit converter may require INLET/OUTLET pipe resizing.

③ Federal & California Emissions. Not For Sale or Use on vehicles licensed in the state of CA & NY (NY vehicles with CA Emissions). Check with your state authority for details.

□ EPA OBDII By Design Unit

○ EPA Enhanced OBDII By Design Unit

**APPLICATION LISTINGS**  
**FEDERAL CONVERTERS**



YR/YRS	CYL	LITER	DESCRIPTION	DIRECT FIT	UNIVERSAL
<b>BUICK LESABRE (Cont.)</b>					
97-99	6	3.8L	Models w/4 Bolt Flange Inlet, front pipe & conv. separate, for use with OE intermediate pipe, additional sizing, bushings, cutting may be required due to OE exhaust design, # 3 bushing may be required.	4890 ②③ -- -- --	2516③ -- -- --
97-99	6	3.8L	Models w/4 Bolt Flange Inlet, front pipe & conv. separate, for use with aftermarket intermediate pipe, additional sizing, bushings, cutting may be required due to OE exhaust design.	4890G ②③ -- --	2516③ -- --
95-97	6	3.8L	"K" & "L" Eng., front pipe & conv. 1 piece, w/ 2 Bolt Flange, additional sizing, bushings, cutting may be required due to OE exhaust design, # 3 bushing may be required.	4975 ②③ -- --	2516③ -- --
92-94	6	3.8L	Models w/o O2 Sensor, for use with OE intermediate pipe, additional sizing, bushings, cutting may be required due to OE exhaust design, # 3 bushing may be required.	4646 ②③ -- --	6906③ -- --
92-94	6	3.8L	Models w/o O2 Sensor, for use with aftermarket intermediate pipe, additional sizing, bushings, cutting may be required due to OE exhaust design.	4646G ②③ -- --	6906③ -- --
88-91	6	3.8L	For use with OE intermediate pipe, # 6 bushing may be required with aftermarket pipe.	4120 ②③ --	6905③ --
88-91	6	3.8L	For use with 2-3/8" I.D. aftermarket intermediate pipe.	4120G ③	6905③
1979	6	3.8L	Turbo, Angled Conv.	--	6906③
1979	6	3.8L	Turbo, Straight Conv.	--	6005③
77-79	6	3.8L	(Exc. Turbo)	--	6906③
1976	6	3.8L		--	6906③
86-87	6	All	For use with OE intermediate pipe.	4501 ②③	6905③
86-87	6	All	For use with 2-3/8" I.D. aftermarket intermediate pipe.	--	6905③
83-85	6	All		4112 ☆③	6905③
81-82	6	All		4111 ☆③	6005③
1980	6	All	w/o Air Tube	--	6906③
1980	6	All	w/Air Tube	--	6006③
1980	8	4.9L		--	6906③
85-90	8	5.0L	Station Wgn.	4119 ☆③	6005③
84-85	8	5.0L	LeSabre, (Exc. Station Wgn.)	4119 ☆③	6005③
81-83	8	5.0L		4111 ☆③	6005③
1980	8	5.7L	Code "X"	--	6906③
1980	8	5.7L	Code "R"	--	6005③
75-76	8	7.5L	455 C.I.D.	--	8006③
77-79	8	All		--	6906③
75-76	8	All	(Exc. 455 C.I.D.)	--	6906③
<b>BUICK LUCERNE</b>					
06-08	6	3.8L		--	2575③○
06-08	6	3.8L		5220 ③	--
09-11	6	3.9L	Front	5222 ③	--
06-08	8	4.6L		--	2575③○
<b>BUICK PARK AVENUE</b>					
00-05	6	3.8L	(Exc. Supercharged, Use w/OE Pipe, Includes Resonator )	9035 ③	2517③
00-05	6	3.8L	For use with Aftermarket pipes, additional sizing, bushings, cutting may be required due to OE exhaust design.	9988 ③ --	2517③ --

☆ Air Tube kit 4948 may be required for installation.

② When using with aftermarket piping, direct fit converter may require INLET/OUTLET pipe resizing.

③ Federal & California Emissions. Not For Sale or Use on vehicles licensed in the state of CA & NY (NY vehicles with CA Emissions). Check with your state authority for details.

○ EPA Enhanced OBDII By Design Unit

YR/YRS	CYL	LITER	DESCRIPTION	DIRECT FIT	UNIVERSAL
<b>BUICK PARK AVENUE (Cont.)</b>					
97-00	6	3.8L	Supercharged Eng., Additional sizing, bushings, cutting may be required due to OE exhaust design.	4197 ③ --	2516③ --
97-99	6	3.8L	Models w/4 Bolt Flange Inlet, 2nd design front pipe & conv. separate, for use with OE intermediate pipe, additional sizing, bushings, cutting may be required due to OE exhaust design, # 3 bushing may be required.	4890 ②③ -- -- --	2516③ -- -- --
97-99	6	3.8L	Models w/4 Bolt Flange Inlet, 2nd design front pipe & conv. separate, for use with aftermarket intermediate pipe, additional sizing, bushings, cutting may be required due to OE exhaust design.	4890G ②③ -- --	2516③ -- --
1996	6	3.8L	Supercharged Code "1" Eng., w/front pipe, additional sizing, bushings, cutting may be required due to OE exhaust design, # 3 bushing may be required.	4975 ②③ -- --	2516③ -- --
95-96	6	3.8L	"K" Eng. w/Post Conv. O2 Sensor, w/front pipe, (Exc. Supercharged), additional sizing, bushings, cutting may be required due to OE exhaust design, # 3 bushing may be required.	4975 ②③ -- --	2516③ -- --
91-94	6	3.8L	Models w/o O2 Sensor, for use with OE intermediate pipe, additional sizing, bushings, cutting may be required due to OE exhaust design, # 3 bushing may be required.	4646 ②③ -- --	6906③ -- --
91-94	6	3.8L	Models w/o O2 Sensor, for use with aftermarket intermediate pipe, additional sizing, bushings, cutting may be required due to OE exhaust design.	4646G ②③ -- --	6906③ -- --
<b>BUICK RAINIER</b>					
06-07	6	4.2L		9171 ③	2506③
04-05	6	4.2L		9154 ③	2506R③
2007	8	5.3L		--	2565R③
06-07	8	5.3L		9544 ③	--
05-06	8	5.3L		9412 ③	2566③
2004	8	5.3L		9879 ③ 4678 ③④	-- 2565R③
<b>BUICK REATTA</b>					
1991	6	3.8L	Additional sizing, bushings, cutting may be required due to OE exhaust design.	4211 ②③ --	6906③ --
88-90	6	3.8L	Additional sizing, bushings, cutting may be required due to OE exhaust design.	-- --	6905③ --
<b>BUICK REGAL</b>					
88-89	6	2.8L	For use with OE intermediate pipe, additional sizing, bushings, cutting may be required due to OE exhaust design, # 6 bushing may be required at inlet & # 8 bushing may be required at outlet for use w/aftermarket pipe.	4137 ②③ -- -- --	6905③ -- -- --
88-89	6	2.8L	For use with 2-1/8" I.D. aftermarket intermediate pipe, additional sizing, bushings, cutting may be required due to OE exhaust design.	4137G ②③ --	6905③ --
95-96	6	3.1L	w/Post Conv. O2 Sensor	4838 ③	2505R③
94-95	6	3.1L	(Exc. w/Post Conv. O2 Sensor)	4629 ③	6904R③
1993	6	3.1L	Federal Emissions, For use with OE intermediate pipe, additional sizing, bushings, cutting may be required due to OE exhaust design, # 6 bushing may be required at inlet & # 8 bushing may be required at outlet for use w/aftermarket pipe.	4137 ②④ -- -- --	6905④ -- -- --

① Discontinued, use until inventory is depleted.

② When using with aftermarket piping, direct fit converter may require INLET/OUTLET pipe resizing.

③ Federal & California Emissions. Not For Sale or Use on vehicles licensed in the state of CA & NY (NY vehicles with CA Emissions). Check with your state authority for details.

④ Federal Emissions. Not For Sale or Use on vehicles licensed in the state of CA. Check with your state authority.

# APPLICATION LISTINGS

## FEDERAL CONVERTERS



YR/YRS	CYL	LITER	DESCRIPTION	DIRECT FIT	UNIVERSAL
<b>BUICK REGAL (Cont.)</b>					
1993	6	3.1L	Federal Emissions, For use with 2-1/8" I.D. aftermarket intermediate pipe, additional sizing, bushings, cutting may be required due to OE exhaust design.	4137G ②④ -- --	6905④ -- --
89-92	6	3.1L	For use with OE intermediate pipe, additional sizing, bushings, cutting may be required due to OE exhaust design, # 6 bushing may be required at inlet & # 8 bushing may be required at outlet for use w/aftermarket pipe.	4137 ②③ -- -- --	6905③ -- -- --
89-92	6	3.1L	For use with 2-1/8" I.D. aftermarket intermediate pipe, additional sizing, bushings, cutting may be required due to OE exhaust design.	4137G ②③ --	6905③ --
97-04	6	3.8L		4876 ③ --	2576R③○ 2506R③□
1996	6	3.8L	w/Resonator	4898 ③	2506R③
94-95	6	3.8L		4216 ③	6905③
90-93	6	3.8L		4302 ③	6906③
86-87	6	3.8L	Turbo Grand National Pkg.	--	6906③
85-87	6	3.8L		4112 ☆③	6005③
1984	6	3.8L	(Exc. Turbo)	4112 ☆③	6005③
1983	6	3.8L	Federal Emissions, (Exc. Turbo)	4112 ☆④	6005④
1983	6	3.8L	California Emissions, (Exc. Turbo)	--	6005⑤
1980	6	3.8L		--	6006③
78-79	6	3.8L	Turbo	--	6906③
78-79	6	3.8L	(Exc. Turbo)	4111 ☆③	6905③
75-76	6	3.8L		--	6906③
83-84	6	4.1L		4112 ☆③	6005③
81-82	6	All		4111 ☆③	6005③
1979	8	4.9L		--	6005③
86-87	8	5.0L		4112 ☆③	6005③
83-85	8	5.0L	Code "H"	4115 ☆③	6005③
78-79	8	5.0L	Code "H"	--	6906③
1978	8	5.0L	Code "U"	--	6005③
80-82	8	All	w/ Air Tube	4111 ☆③	6005③
80-82	8	All	w/o Air Tube	--	6906③
75-77	8	All		--	6906③
<b>BUICK RENDEZVOUS</b>					
02-05	6	3.4L	AWD	4246 ③	2576R③○
02-05	6	3.4L	FWD	4760 ③	2565R③□
06-07	6	3.5L	FWD	4760 ③	2565R③□
06-07	6	3.5L	AWD	--	2565R③□
<b>BUICK RIVIERA</b>					
97-99	6	3.8L	Supercharged Eng.	4197 ③	2516③
1997	6	3.8L	Models w/4 Bolt Flange Inlet, 2nd design front pipe & conv. separate, for use with OE intermediate pipe, additional sizing, bushings, cutting may be required due to OE exhaust design, # 3 bushing may be required.	4890 ②③ -- -- --	2516③ -- -- --
1997	6	3.8L	Models w/4 Bolt Flange Inlet, 2nd design front pipe & conv. separate, for use with aftermarket intermediate pipe, additional sizing, bushings, cutting may be required due to OE exhaust design.	4890G ②③ -- --	2516③ -- --

☆ Air Tube kit 4948 may be required for installation.

② When using with aftermarket piping, direct fit converter may require INLET/OUTLET pipe resizing.

③ Federal & California Emissions. Not For Sale or Use on vehicles licensed in the state of CA & NY (NY vehicles with CA Emissions). Check with your state authority for details.

④ Federal Emissions. Not For Sale or Use on vehicles licensed in the state of CA. Check with your state authority.

⑤ California Emissions. Not For Sale or Use on vehicles licensed in the state of CA & NY. Check with your state authority.

□ EPA OBDII By Design Unit

○ EPA Enhanced OBDII By Design Unit

YR/YRS	CYL	LITER	DESCRIPTION	DIRECT FIT	UNIVERSAL
<b>BUICK RIVIERA (Cont.)</b>					
1996	6	3.8L	Code "1"	--	2539③
95-96	6	3.8L	Code "K" Eng.	4975 ③	2516③
91-93	6	3.8L	For use with OE intermediate pipe, additional sizing, bushings, cutting may be required due to OE exhaust design.	--	6006③
91-93	6	3.8L		--	--
91-93	6	3.8L		--	6006③
88-90	6	3.8L	Additional sizing, bushings, cutting may be required due to OE exhaust design, two # 6 bushing may be required.	--	6904③
88-90	6	3.8L		--	--
86-87	6	3.8L	For use with OE intermediate pipe, # 6 bushing may be required with aftermarket pipe.	4120 ②③	6905③
86-87	6	3.8L		--	--
86-87	6	3.8L	For use with 2-3/8" I.D. aftermarket intermediate pipe.	4120G ③	6905③
84-85	6	3.8L	Turbo	4112 ☆③	6005③
81-83	6	3.8L	Turbo	4112 ☆③	6005③
79-80	6	3.8L	Turbo	--	6906③
1984	6	4.1L		4112 ☆③	6005③
81-83	6	4.1L		4111 ☆③	6005③
1995	6	All	w/Supercharged Eng., additional sizing, bushings, cutting may be required due to OE exhaust design, # 3 bushing may be required.	--	6906③
84-85	8	5.0L		--	--
84-85	8	5.0L		4119 ☆③	6005③
81-83	8	5.0L		4111 ☆③	6005③
1980	8	5.7L	Code "R"	--	6905③
77-79	8	5.7L		--	6906③
77-78	8	6.6L		--	8006③
75-76	8	7.5L		--	8006③
<b>BUICK ROADMASTER</b>					
1991	8	5.0L	Station Wgn.	9133 ☆③	2905③
1991	8	5.0L	Optional Direct Fit Converter	4115 ☆③	6005③
95-96	8	5.7L	Right	9403 ③	2515③
95-96	8	5.7L	Left	9404 ③	2515③
1994	8	5.7L	Right	9403 ③	2905③
1994	8	5.7L	Left	9404 ③	2905③
92-93	8	5.7L	(Exc. Station Wgn.)	4115 ☆③	6005③
92-93	8	5.7L	Station Wgn.	9133 ☆③	2905③
<b>BUICK SKYHAWK</b>					
84-86	4	1.8L	Turbo	--	6004③
82-86	4	1.8L	(Exc. Turbo)	--	6003③
87-89	4	2.0L	Code "1", Additional sizing, bushings, cutting may be required due to OE exhaust design.	4117 ②③	6904③
87-88	4	2.0L		--	--
87-88	4	2.0L	Code "K"	--	6004③
1987	4	2.0L	Code "M" Turbo	--	6005③
75-80	6	3.8L		--	6905③
<b>BUICK SKYLARK</b>					
93-95	4	2.3L		4719 ③	6905R③
1992	4	2.3L		--	6903③
90-91	4	2.3L		--	6905③
88-89	4	2.3L	Additional sizing, bushings, cutting may be required due to OE exhaust design.	--	6905③
96-98	4	2.4L		--	--
96-98	4	2.4L		4823 ③	2504R③

☆ Air Tube kit 4948 may be required for installation.

② When using with aftermarket piping, direct fit converter may require INLET/OUTLET pipe resizing.

③ Federal & California Emissions. Not For Sale or Use on vehicles licensed in the state of CA & NY (NY vehicles with CA Emissions). Check with your state authority for details.

**APPLICATION LISTINGS  
FEDERAL CONVERTERS**



YR/YRS	CYL	LITER	DESCRIPTION	DIRECT FIT	UNIVERSAL
<b>BUICK SKYLARK (Cont.)</b>					
90-91	4	2.5L		4595 ③	6904 ③
90-91	4	2.5L	Optional Direct Fit Converter	--	6904 ③
86-89	4	2.5L	Additional sizing, bushings, cutting may be required due to OE exhaust design, Two # 8 bushings may be required (1 at inlet & 1 at outlet).	4117 ②③	6904 ③
				--	--
				--	--
82-85	4	2.5L		--	6004 ③
1981	4	2.5L		--	6003 ③
1980	4	2.5L		--	6904 ③
83-85	6	2.8L		--	6004 ③
1982	6	2.8L	Code "Z" Eng.	4303 ☆③	6005 ③
1982	6	2.8L	Code "X" Eng.	--	6004 ③
1981	6	2.8L		--	6003 ③
1980	6	2.8L		--	6904 ③
97-98	6	3.1L		4849 ③	2504R ③
1996	6	3.1L		4862 ③	2504R ③
94-95	6	3.1L		4793 ③	6904R ③
90-93	6	3.3L		4589 ③	6905 ③
86-89	6	All	Additional sizing, bushings, cutting may be required due to OE exhaust design, Two # 8 bushings may be required (1 at inlet & 1 at outlet).	4117 ②③	6904 ③
				--	--
				--	--
75-79	6,8	All		--	6905 ③
<b>BUICK SOMERSET - SOMERSET REGAL</b>					
85-87	4,6	All	Additional sizing, bushings, cutting may be required due to OE exhaust design, Two # 8 bushings may be required (1 at inlet & 1 at outlet).	4117 ②③	6904 ③
				--	--
				--	--
<b>BUICK TERRAZA</b>					
05-06	6	3.5L	FWD	4429 ③	2566 ③
2007	6	3.9L		4464 ③	2565 ③
<b>CADILLAC ALLANTE</b>					
87-88	8	4.1L	Additional sizing, bushings, cutting may be required due to OE exhaust design.	--	6006 ③
				--	--
89-92	8	4.5L		4516 ☆③	6006 ③
1993	8	4.6L		4516 ☆③	6006 ③
<b>CADILLAC CATERA</b>					
97-01	6	3.0L	Right	4256 ③	2504 ③
97-01	6	3.0L	Left	4257 ③	2504 ③
<b>CADILLAC CIMARRON</b>					
82-86	4	All		--	6003 ③
87-88	6	2.8L	Additional sizing, bushings, cutting may be required due to OE exhaust design.	4117 ②③	6904 ③
				--	--
85-86	6	2.8L		--	6904 ③
<b>CADILLAC COMMERCIAL CHASSIS - FUNERAL COACH, LIMOUSINE</b>					
86-87	8	4.1L	For use with OE intermediate pipe, # 6 bushing may be required with aftermarket pipe.	4120 ②③	6905 ③
				--	--
86-87	8	4.1L	For use with 2-3/8" I.D. aftermarket intermediate pipe.	4120G ③	6905 ③
88-90	8	4.5L	w/Air Tube, additional sizing, bushings, cutting may be required due to OE exhaust design.	4524 ☆②③	2906 ③
				--	--

☆ Air Tube kit 4948 may be required for installation.

② When using with aftermarket piping, direct fit converter may require INLET/OUTLET pipe resizing.

③ Federal & California Emissions. Not For Sale or Use on vehicles licensed in the state of CA & NY (NY vehicles with CA Emissions). Check with your state authority for details.



YR/YRS	CYL	LITER	DESCRIPTION	DIRECT FIT	UNIVERSAL
<b>CADILLAC COMMERCIAL CHASSIS - FUNERAL COACH, LIMOUSINE (Cont.)</b>					
88-90	8	4.5L	w/o Air Tube	4211 ③	6906③
1992	8	4.9L	Large Body for sound control, additional sizing, bushings, cutting may be required due to OE exhaust design.	9036 ☆②③	2906③
				--	--
94-95	8	5.7L	Code "P", Left	9404 ③	2905③
94-95	8	5.7L	Code "P", Right	9403 ③	2905③
81-84	8	6.0L		--	9005③
1980	8	6.0L		--	8006③
77-79	8	7.0L		--	8006③
1993	8	All		9133 ☆③	6906③
<b>CADILLAC CTS</b>					
05-07	6	2.8L	Right Side	4546 ③	--
05-07	6	2.8L	Left Side	4547 ③	--
03-04	6	3.2L	Right, (Exc. Towing Package)	4766 ③	2565R③
03-04	6	3.2L	Left, (Exc. Towing Package)	4767 ③	2565R③
08-11	6	3.6L	RWD, Right	4584 ③	--
08-11	6	3.6L	RWD, Left	4585 ③	--
04-07	6	3.6L	Right Side	4546 ③	2565③
04-07	6	3.6L	Left Side	4547 ③	2565③
<b>CADILLAC DEVILLE</b>					
81-82	6	4.1L		4111 ☆③	6005③
1980	6	4.1L		--	6906③
86-87	8	4.1L	For use with OE intermediate pipe, w/o Air Tube, # 6 bushing may be required with aftermarket pipe.	4120 ②③	6905③
				--	--
86-87	8	4.1L	For use with 2-3/8" I.D. aftermarket intermediate pipe.	4120G ③	6905③
1985	8	4.1L		4303 ③	6005③
1984	8	4.1L		4119 ☆③	6005③
82-83	8	4.1L		4111 ☆③	6005③
88-90	8	4.5L	Large Body for sound control, additional sizing, bushings, cutting may be required due to OE exhaust design, # 3 bushing may be required.	9036 ☆②③	2906③
				--	--
				--	--
00-05	8	4.6L	Use w/OE Pipe, Includes Resonator	9035 ③	--
00-05	8	4.6L	For use with Aftermarket pipes, additional sizing, bushings, cutting may be required due to OE exhaust design.	9988 ③	2517③
				--	--
96-99	8	4.6L	For use with O.E. Piping, additional sizing, bushings, cutting may be required due to OE exhaust design.	4840 ②③	2516③
				--	--
94-95	8	4.6L	Additional sizing, bushings, cutting may be required due to OE exhaust design.	4516 ☆②③	6006③
				--	--
94-95	8	4.9L	For use with OE intermediate pipe, additional sizing, bushings, cutting may be required due to OE exhaust design.	4742 ②③	6906③
				--	--
94-95	8	4.9L		4742G ②③	6906③
92-93	8	4.9L	For use with OE pipes, additional sizing, bushings, cutting may be required due to OE exhaust design.	4211 ②③	6906③
				--	--
92-93	8	4.9L	For use with Aftermarket pipes, additional sizing, bushings, cutting may be required due to OE exhaust design.	--	6906③
				--	--
1991	8	4.9L	Additional sizing, bushings, cutting may be required due to OE exhaust design, # 3 bushing may be required on inlet w/aftermarket pipe.	4815 ②③	6906③
				--	--
				--	--

☆ Air Tube kit 4948 may be required for installation.

② When using with aftermarket piping, direct fit converter may require INLET/OUTLET pipe resizing.

③ Federal & California Emissions. Not For Sale or Use on vehicles licensed in the state of CA & NY (NY vehicles with CA Emissions). Check with your state authority for details.

# APPLICATION LISTINGS

## FEDERAL CONVERTERS



YR/YRS	CYL	LITER	DESCRIPTION	DIRECT FIT	UNIVERSAL
<b>CADILLAC DEVILLE (Cont.)</b>					
80-81	8	6.0L		--	8005③
77-79	8	7.0L		--	8006③
<b>CADILLAC DTS</b>					
06-11	8	4.6L	Includes Resonator	9035 ③ <sup>242</sup>	--
<b>CADILLAC ELDORADO</b>					
81-82	6	4.1L		4111 ☆③	6005③
86-87	8	4.1L	Additional sizing, bushings, cutting may be required due to OE exhaust design, # 6 bushing may be required.	4303 ②③	6005③
84-85	8	4.1L		--	2905③
82-83	8	4.1L		4111 ☆③	6005③
1990	8	4.5L	For use with OE intermediate pipe, additional sizing, bushings, cutting may be required due to OE exhaust design.	4516 ☆②③	6006③
1990	8	4.5L		4516G ☆②③	6006③
88-89	8	4.5L	Additional sizing, bushings, cutting may be required due to OE exhaust design, # 3 bushing may be required.	--	6006③
96-99	8	4.6L	For use with OE pipes, additional sizing, bushings, cutting may be required due to OE exhaust design.	4840 ②③	2516③
93-95	8	4.6L	For use with OE intermediate pipe, additional sizing, bushings, cutting may be required due to OE exhaust design.	4516 ☆②③	6006③
93-95	8	4.6L		4516G ☆②③	6006③
1993	8	4.9L	For use with OE pipes, additional sizing, bushings, cutting may be required due to OE exhaust design.	4742 ②③	6906③
1993	8	4.9L		4742G ②③	6906③
91-92	8	4.9L	For use with OE pipes, additional sizing, bushings, cutting may be required due to OE exhaust design.	4516 ☆②③	6006③
91-92	8	4.9L		4516G ☆②③	6006③
79-80	8	5.7L		--	6906③
80-81	8	6.0L		--	9005③
77-78	8	7.0L		--	8006③
<b>CADILLAC ESCALADE</b>					
02-05	8	5.3L	Dual Convs.	9083 ③④	--
			Dual Convs.	9444 ③	2506R③
99-00	8	5.7L	Dual Convs.	9333 ③	2540③
04-06	8	6.0L	Right	9266 ③	2506R③
04-06	8	6.0L	Left	9267 ③	2506R③
02-03	8	6.0L	Right	9266 ③	2506R③
02-03	8	6.0L	Left	9267 ③	2506R③
07-10	8	6.2L	AWD, Federal Tier 2 Emissions	9642 ④	--
<b>CADILLAC FLEETWOOD</b>					
81-82	6	4.1L		4111 ☆③	6005③
1980	6	4.1L		--	6906③
86-87	8	4.1L	For use with OE intermediate pipe, #6 bushing may be required with aftermarket pipe.	4120 ②③	6905③
86-87	8	4.1L	Optional Conv. w/Air Tube, additional sizing, bushings, cutting may be required due to OE exhaust design.	4524 ☆②③	6005③
86-87	8	4.1L	For use with 2-3/8" I.D. aftermarket intermediate pipe.	4120G ③	6905③
82-83	8	4.1L		4111 ☆③	6005③

④ Discontinued, use until inventory is depleted.

☆ Air Tube kit 4948 may be required for installation.

<sup>242</sup> The O.E. system must be cut off 16" behind the rear resonator weld.

② When using with aftermarket piping, direct fit converter may require INLET/OUTLET pipe resizing.

③ Federal & California Emissions. Not For Sale or Use on vehicles licensed in the state of CA & NY (NY vehicles with CA Emissions). Check with your state authority for details.

④ Federal Emissions. Not For Sale or Use on vehicles licensed in the state of CA. Check with your state authority.

YR/YRS	CYL	LITER	DESCRIPTION	DIRECT FIT	UNIVERSAL
<b>CADILLAC FLEETWOOD (Cont.)</b>					
88-90	8	4.5L	Additional sizing, bushings, cutting may be required due to OE exhaust design, # 3 bushing may be required.	4524 ☆②③ --	2906③ --
1992	8	4.9L	Large Body for sound control, additional sizing, bushings, cutting may be required due to OE exhaust design, # 3 bushing may be required.	9036 ☆②③ -- --	2906③ -- --
1991	8	4.9L	Additional sizing, bushings, cutting may be required due to OE exhaust design, # 3 bushing may be required on inlet w/aftermarket pipe.	4815 ②③ -- --	6906③ -- --
1986	8	5.0L		9133 ☆③	2905③
1996	8	5.7L	Right	9403 ③	2515③
1996	8	5.7L	Left	9404 ③	2515③
94-95	8	5.7L	Right	9403 ③	2905③
94-95	8	5.7L	Left	9404 ③	2905③
1993	8	5.7L		9133 ☆③	2905③
80-84	8	6.0L		--	9005③
77-79	8	7.0L		--	8006③
<b>CADILLAC SEVILLE</b>					
81-82	6	4.1L		4111 ☆③	6005③
86-87	8	4.1L	Additional sizing, bushings, cutting may be required due to OE exhaust design, # 6 bushing may be required.	4303 ②③ --	6005③ --
84-85	8	4.1L		--	2905③
82-83	8	4.1L		4111 ☆③	6005③
1990	8	4.5L	For use with OE pipes, additional sizing, bushings, cutting may be required due to OE exhaust design.	4516 ☆②③ --	6006③ --
1990	8	4.5L		4516G ☆②③	6006③
88-89	8	4.5L	Additional sizing, bushings, cutting may be required due to OE exhaust design, # 3 bushing may be required.	-- --	6006③ --
98-03	8	4.6L	STS Models, Conv. Unit includes Resonator, Use With OE Center Pipe	9027 ③ --	2516③ --
96-97	8	4.6L	For use with OE pipes, additional sizing, bushings, cutting may be required due to OE exhaust design.	4840 ②③ --	2516③ --
1995	8	4.6L	Additional sizing, bushings, cutting may be required due to OE exhaust design.	4516 ☆②③ --	6006③ --
93-94	8	4.6L	For use with OE intermediate pipe, additional sizing, bushings, cutting may be required due to OE exhaust design.	4516 ☆②③ --	6006③ --
93-94	8	4.6L		4516G ☆②③	6006③
1993	8	4.9L	For use with OE intermediate pipe, additional sizing, bushings, cutting may be required due to OE exhaust design.	4742 ②③ --	6906③ --
1993	8	4.9L		4742G ②③	6906③
91-92	8	4.9L	For use with OE intermediate pipe, additional sizing, bushings, cutting may be required due to OE exhaust design.	4516 ☆②③ --	6006③ --
91-92	8	4.9L		4516G ☆②③	6006③
79-80	8	5.7L		--	6906③
77-78	8	5.7L	w/Flanged Outlet Pipe	--	6906③
76-77	8	5.7L	w/Flanged Inlet and Outlet	--	6905③
80-81	8	6.0L		--	9005③

☆ Air Tube kit 4948 may be required for installation.

② When using with aftermarket piping, direct fit converter may require INLET/OUTLET pipe resizing.

③ Federal & California Emissions. Not For Sale or Use on vehicles licensed in the state of CA & NY (NY vehicles with CA Emissions). Check with your state authority for details.

**APPLICATION LISTINGS  
FEDERAL CONVERTERS**



YR/YRS	CYL	LITER	DESCRIPTION	DIRECT FIT	UNIVERSAL
<b>CADILLAC SRX</b>					
2009	6	3.6L	RWD, Right	4584 ③	2565R③
2009	6	3.6L	RWD, Left	4585 ③	2565R③
2008	6	3.6L	Left	--	2565R③
2008	6	3.6L	Right	--	2565R③
04-07	6	3.6L	Right	4618 ③	--
04-07	6	3.6L	Left	4619 ③	--
07-09	8	4.6L	Right	--	2565③
07-09	8	4.6L	Left	--	2565③
04-09	8	4.6L	Manifold Unit, Front Left	1342 ③	--
04-09	8	4.6L	Manifold Unit, Front Right	1343 ③	--
<b>CADILLAC STS</b>					
08-11	6	3.6L	RWD, Right	4584 ③	--
08-11	6	3.6L	RWD, Left	4585 ③	--
05-07	6	3.6L	Right Side	4618 ③	--
05-07	6	3.6L	Left Side	4619 ③	--
05-10	8	4.6L	Manifold Unit, Front Left	1342 ③	--
05-10	8	4.6L	Manifold Unit, Front Right	1343 ③	--
<b>CADILLAC XLR</b>					
2006	8	4.4L	Right	--	2565R③
2006	8	4.4L	Left	--	2565R③
05-07	8	4.6L	Right	--	2565R③
05-07	8	4.6L	Left	--	2565R③
<b>CHECKER MARATHON</b>					
81-82	6	3.8L	Marathon Models	--	2905③
77-80	6	All		4001 ③	6906③
75-80	8	All		9002 ③	8006③
<b>CHEVROLET ASTRO VAN</b>					
88-90	4	2.5L		--	6905③
85-87	4	2.5L		--	6905③
00-05	6	4.3L	California Emissions	9148 ⑤	--
00-01	6	4.3L	Federal Emissions	9132 ④	2517④
96-99	6	4.3L		9075 ③	2517③
94-95	6	4.3L	(Exc. AWD)	9594 ③	2907③
94-95	6	4.3L	AWD	9028 ③	2907③
1993	6	4.3L		9184 ③	2907③
1992	6	4.3L	Code "Z" Eng., 2-1/2" Pipe	9529 ③	2906③
1992	6	4.3L	Code "W" Eng.	9184 ③	2907③
86-91	6	4.3L		9002 ③	2906③
1985	6	4.3L		4001 ③	6906③
<b>CHEVROLET AVEO</b>					
04-08	4	1.6L		4405 ③	--
09-11	6	1.6L	Rear	4404 ③	--
<b>CHEVROLET AVEO5</b>					
09-11	4	1.6L	Rear	4404 ③	--
07-08	4	1.6L		4405 ③	--

③ Federal & California Emissions. Not For Sale or Use on vehicles licensed in the state of CA & NY (NY vehicles with CA Emissions). Check with your state authority for details.  
 ④ Federal Emissions. Not For Sale or Use on vehicles licensed in the state of CA. Check with your state authority.  
 ⑤ California Emissions. Not For Sale or Use on vehicles licensed in the state of CA & NY. Check with your state authority.

YR/YRS	CYL	LITER	DESCRIPTION	DIRECT FIT	UNIVERSAL
<b>CHEVROLET BERETTA</b>					
87-89	4	2.0L	Additional sizing, bushings, cutting may be required due to OE exhaust design.	4306 ☆②③ --	6904③ --
1996	4	2.2L		4817 ③	2504③
93-95	4	2.2L		4414 ③	6904③
93-95	4	2.2L	Optional Direct Fit Converter	--	6904③
90-92	4	2.2L	Additional sizing, bushings, cutting may be required due to OE exhaust design.	4306 ☆②③ --	6904③ --
93-94	4	2.3L		4414 ②③	6904③
93-94	4	2.3L	Optional Direct Fit Converter	--	6904③
90-92	4	2.3L	GTZ Models, Additional sizing, bushings, cutting may be required due to OE exhaust design.	-- --	6905③ --
1996	6	3.1L		4862 ③	2504③
94-95	6	3.1L	Conv. w/Front pipe	4793 ③	6904③
94-95	6	3.1L	Semi Direct Fit Conv. Must Reuse Front Pipe	--	6904③
1993	6	3.1L	Additional sizing, bushings, cutting may be required due to OE exhaust design.	4117 ②③ --	6904③ --
87-92	6	All	Additional sizing, bushings, cutting may be required due to OE exhaust design.	4306 ☆②③ --	6904③ --
<b>CHEVROLET BLAZER FULL SIZE</b>					
75-82	6	4.1L		4001 ③	6906③
1994	8	5.7L	Code "K" Eng., w/Conv. In Y-Pipe	9648 ③	2907③
1994	8	5.7L	(Exc. Conv. In Y-Pipe)	9184 ③	2907③
87-93	8	5.7L		9184 ③	2907③
75-78	8	6.6L	400 C.I.D.	9002 ③	8006③
83-87	8	All	(Exc. 1987, 350 C.I.D., 5.7L)	9002 ③	2906③
75-82	8	All	(Exc. 400 C.I.D.)	4001 ③	6906③
<b>CHEVROLET BLAZER S-Series</b>					
83-88	4	All	All	4019 ③	6905③
83-87	6	2.8L		4019 ③	6905③
01-05	6	4.3L	Complete Assembly, 2WD, 2 Dr., California Emissions, Auto Trans.	9209 ⑤	--
01-05	6	4.3L	Rear, 2WD, 2 Dr., California Emissions	--	2564R⑤
01-05	6	4.3L	Complete Assembly, 4WD, 2 Dr. California Emissions, Auto Trans.	9210 ⑤	--
01-05	6	4.3L	Rear, 4WD, 2 Dr., California Emissions	--	2516⑤
01-05	6	4.3L	2 Dr., 4WD, Federal Emissions	--	2517④
00-05	6	4.3L	Front, 4WD & Auto Trans. & 4 Dr., California Emissions	--	2576R⑤
00-05	6	4.3L	Rear, 4WD & Auto Trans. & 4 Dr., California Emissions	--	2517⑤
00-05	6	4.3L	Complete Assembly, 2WD, 4 Dr., California Emissions	9214 ⑤	--
00-05	6	4.3L	4WD & Auto Trans. & 4 Dr., California Emissions	9109 ⑤	--
2000	6	4.3L	Complete Assembly, 2WD, 4 Dr., Federal Emissions	9215 ④	--
2000	6	4.3L	2WD, 2 Dr., Federal Emissions	9229 ④	2517④
2000	6	4.3L	4WD & Auto Trans. & 4 Dr., Federal Emissions	9108 ④	2517④
2000	6	4.3L	4WD, 2 Dr., Federal Emissions	9230 ④	2516④
98-99	6	4.3L	Front, California Emissions	1192 ⑤	2538⑤
98-99	6	4.3L	Rear, California Emissions	4792 ⑤	2516⑤
98-99	6	4.3L	Federal Emissions	4792 ④	2516④
96-97	6	4.3L		4792 ③	2516③
1995	6	4.3L	4WD, 2 Dr.	4682 ③	2516③

☆ Air Tube kit 4948 may be required for installation.

② When using with aftermarket piping, direct fit converter may require INLET/OUTLET pipe resizing.

③ Federal & California Emissions. Not For Sale or Use on vehicles licensed in the state of CA & NY (NY vehicles with CA Emissions). Check with your state authority for details.

④ Federal Emissions. Not For Sale or Use on vehicles licensed in the state of CA. Check with your state authority.

70 ⑤ California Emissions. Not For Sale or Use on vehicles licensed in the state of CA & NY. Check with your state authority.

**APPLICATION LISTINGS**  
**FEDERAL CONVERTERS**



YR/YRS	CYL	LITER	DESCRIPTION	DIRECT FIT	UNIVERSAL
<b>CHEVROLET BLAZER S-Series (Cont.)</b>					
1995	6	4.3L	4WD, 4 Dr.	4482 ③	2516③
92-94	6	4.3L	Code "W" Eng.	4880 ③	2906③
92-94	6	4.3L	Code "Z" Eng.	4088 ③	2906③
88-91	6	All		4088 ③	2906③
<b>CHEVROLET C-(2WD), K-(4WD) PICKUP 1/2 TON, (Inc. SILVERADO &amp; AVALANCHE)</b>					
09-13	6	4.3L	Complete Assembly	9273 ③④	--
			Complete Assembly	9912 ③	--
09-13	6	4.3L	Front Right	--	2566③
09-13	6	4.3L	Rear Conv.	--	2506R③
09-13	6	4.3L	Front Left	--	2566③
2008	6	4.3L	Federal Emissions	9233 ④	--
00-06	6	4.3L	Dual Convs. 2000 w/Flat Spot in Middle Pipe	9083 ③④	--
			Dual Convs. 2000 w/Flat Spot in Middle Pipe	9444 ③	2506R③
99-00	6	4.3L	Dual Convs. 2000 w/o Flat Spot in Middle Pipe	9063 ③	2516③
96-98	6	4.3L	(Exc. Dual Conv.)	9720 ③	2517③
94-95	6	4.3L		9648 ③	2907③
1993	6	4.3L	27-1/2" Conv.	9529 ③	2906③
1993	6	4.3L	Closed Coupled Exhaust (Conv. welded to front pipe), (Exc. 27-1/2" Conv.)	--	2906③
				--	--
88-92	6	4.3L		9529 ③	2906③
83-86	6	All		9002 ③	8006③
75-82	6	All		4001 ③	6906③
09-13	8	4.8L	Complete Assembly	9273 ③④	--
09-13	8	4.8L	Front Right	--	2566③
09-13	8	4.8L	Rear Conv.	--	2506R③
09-13	8	4.8L	Front Left	--	2566③
09-13	8	4.8L	Complete Assembly	9912 ③	--
07-08	8	4.8L	Exc. Classic Model, Federal Emissions	9233 ④	--
00-06	8	4.8L	Dual Convs. 2000 w/Flat Spot in Middle Pipe	9083 ③④	--
			Dual Convs. 2000 w/Flat Spot in Middle Pipe	9444 ③	2506R③
99-00	8	4.8L	Dual Convs. 2000 w/o Flat Spot in Middle Pipe	9063 ③	2516③
96-99	8	5.0L	Single Conv.	9720 ③	2517③
94-95	8	5.0L		9648 ③	2907③
1993	8	5.0L	27-1/2" Conv.	9529 ③	2906③
1993	8	5.0L	(Exc. 27-1/2" Conv.)	--	2906③
88-92	8	5.0L		9529 ③	2906③
83-86	8	5.0L		4001 ③	6906③
09-13	8	5.3L	Complete Assembly	9273 ③④	--
09-13	8	5.3L	Front Right	--	2566③
09-13	8	5.3L	Rear Conv.	--	2506R③
09-13	8	5.3L	Front Left	--	2566③
09-13	8	5.3L	Complete Assembly	9912 ③	--
07-08	8	5.3L	Exc. Classic Model, Federal Emissions	9233 ④	--
07-08	8	5.3L	Avalanche, Federal Emissions	9233 ④	--
00-06	8	5.3L	Dual Convs. 2000 w/Flat Spot in Middle Pipe	9083 ③④	--
			Dual Convs. 2000 w/Flat Spot in Middle Pipe	9444 ③	2506R③
99-00	8	5.3L	Dual Convs. 2000 w/o Flat Spot in Middle Pipe	9063 ③	2516③

④ Discontinued, use until inventory is depleted.

③ Federal & California Emissions. Not For Sale or Use on vehicles licensed in the state of CA & NY (NY vehicles with CA Emissions). Check with your state authority for details.

④ Federal Emissions. Not For Sale or Use on vehicles licensed in the state of CA. Check with your state authority.

YR/YRS	CYL	LITER	DESCRIPTION	DIRECT FIT	UNIVERSAL
<b>CHEVROLET C-(2WD), K-(4WD) PICKUP 1/2 TON, (Inc. SILVERADO &amp; AVALANCHE) (Cont.)</b>					
96-99	8	5.7L	Single Conv.	9720 ③	2517③
96-99	8	5.7L	Dual Convs.	9333 ③	2540③
94-95	8	5.7L		9648 ③	2907③
1993	8	5.7L	(Exc. 26-1/4" Conv.)	--	2907③
92-93	8	5.7L	26-1/4" Conv.	9184 ③	2907③
88-91	8	5.7L		9184 ③	2907③
83-86	8	5.7L		9002 ③	2906③
07-08	8	6.0L	Exc. Classic Model, Federal Emissions	9233 ④	--
06-08	8	6.0L	Right	--	2587③○
06-08	8	6.0L	Left	--	2587③○
05-06	8	6.0L	1500HD, Right	9222 ④	--
05-06	8	6.0L	1500HD, Left	9223 ④	--
03-06	8	6.0L	SS Models, Left	9267 ③	--
03-06	8	6.0L	SS Models, Right	9266 ③	--
02-03	8	6.0L	1500HD, Right	9222 ④	--
02-03	8	6.0L	1500HD, Left	9223 ④	--
09-10	8	6.2L		9642 ③	--
90-92	8	7.4L	(Exc. 454 SS)	9184 ③	8007③
90-92	8	7.4L	SS Models, Right	--	8007③
90-92	8	7.4L	SS Models, Left	--	8007③
75-79	8	7.4L		9002 ③	8006③
75-82	8	All	(Exc. 454 C.I.D.)	4001 ③	6906③
<b>CHEVROLET C-(2WD), K-(4WD) PICKUP 3/4 TON, (Inc. SILVERADO &amp; AVALANCHE)</b>					
75-84	6	4.1L		9002 ③	9006③
94-95	6	4.3L	To 8600 lbs GVW	9648 ③	2907③
91-93	6	4.3L	To 8600 lbs GVW, w/3" Piping	9184 ③	2907③
88-93	6	4.3L	To 8600 lbs GVW, w/2-1/2" Piping	9529 ③	2906③
85-86	6	4.3L	C2500	9002 ③	2906③
96-98	8	5.0L		9720 ③	2517③
94-95	8	5.0L	To 8600 lbs GVW	9648 ③	2907③
88-93	8	5.0L		9529 ③	2906③
83-86	8	5.0L		9002 ③	2906③
2000	8	5.3L	Dual Convs. 2000 w/Flat Spot in Middle Pipe	9083 ③○	--
			Dual Convs. 2000 w/Flat Spot in Middle Pipe	9444 ③	2506R③
99-00	8	5.3L	Dual Convs. 2000 w/o Flat Spot in Middle Pipe	9063 ③	2516③
96-00	8	5.7L	8600 lbs GVW and Over, Front	9092 ③	2517③
96-00	8	5.7L	8600 lbs GVW and Over, 155.5" W.B., Rear	9293 ②③	2517③
96-99	8	5.7L	8600 lbs GVW and Over, 141.5" W.B., Rear	9093 ③	2517③
96-99	8	5.7L	8600 lbs GVW and Over, 131.5" W.B., Rear	9192 ③	2517③
96-98	8	5.7L	Dual Convs., to 8600 lbs GVW	9333 ③	2539③
94-95	8	5.7L	To 8600 lbs GVW	9648 ③	2907③
88-93	8	5.7L	To 8600 lbs GVW	9184 ③	8007③
88-93	8	5.7L	Models w/Rear Conv. behind muffler, to 8600 lbs GVW	9186 ③	8007③
88-93	8	5.7L	To 11000 lbs GVW	10903 ③	10907③
88-93	8	5.7L	Models w/Rear Conv. behind muffler, to 11000 lbs GVW	--	10907③
83-86	8	5.7L		9002 ③	2906③
11-13	8	6.0L	2500 HD, w/o Third Converter	9545 ③	--

① Discontinued, use until inventory is depleted.

② When using with aftermarket piping, direct fit converter may require INLET/OUTLET pipe resizing.

③ Federal & California Emissions. Not For Sale or Use on vehicles licensed in the state of CA & NY (NY vehicles with CA Emissions). Check with your state authority for details.

④ Federal Emissions. Not For Sale or Use on vehicles licensed in the state of CA. Check with your state authority.

**APPLICATION LISTINGS  
FEDERAL CONVERTERS**



YR/YRS	CYL	LITER	DESCRIPTION	DIRECT FIT	UNIVERSAL
<b>CHEVROLET C-(2WD), K-(4WD) PICKUP 3/4 TON, (Inc. SILVERADO &amp; AVALANCHE) (Cont.)</b>					
07-09	8	6.0L	2500 HD	9873 ③	--
06-08	8	6.0L	Right	--	2587③○
06-08	8	6.0L	Left	--	2587③○
03-06	8	6.0L	2500 HD, California Emissions, Right	9878 ⑤	--
03-06	8	6.0L	2500 HD, California Emissions, Left	9877 ⑤	--
01-06	8	6.0L	2500 HD, 143.5", 153", 157.5", 167" WB, Federal Emissions, Right Side, OE System is completely welded. Additional sizing, bushings, cutting may be required.	9222 ④	--
01-06	8	6.0L	2500 HD, 143.5", 153", 157.5", 167" WB, Federal Emissions, Left Side, OE System is completely welded. Additional sizing, bushings, cutting may be required.	9223 ④	--
01-06	8	6.0L	2500 HD, 133" WB, Federal Emissions, Left Side, OE System is completely welded. Additional sizing, bushings, cutting may be required.	9223 ④	--
01-06	8	6.0L	2500 HD, 133" WB, Federal Emissions, Right Side, OE System is completely welded. Additional sizing, bushings, cutting may be required.	9990 ④	--
01-03	8	6.0L	Federal Emissions	--	10907④
01-03	8	6.0L	Right, California Emissions	--	8007⑤
01-03	8	6.0L	Left, California Emissions	--	8007⑤
01-02	8	6.0L	2500 HD, Incomplete Chassis, Left	9277 ③	--
01-02	8	6.0L	2500 HD, Incomplete Chassis, Right	9276 ③	--
2001	8	6.0L	143.5" W.B., Federal Emissions, Right, O.E. System is Completely Welded, Replace With Complete AP System	9980 ④	--
2001	8	6.0L	Federal Emissions, Left, O.E. System is completely welded, Replace with complete AP system	9213 ④	--
99-00	8	6.0L	Right, 6-1/2' Bed	9212 ③	--
99-00	8	6.0L	Left	9213 ③	--
99-00	8	6.0L	143.5" W.B., Right, O.E. System is Completely Welded, Replace With Complete Ap System	9980 ③	--
96-00	8	7.4L	Front, Federal Emissions	9703 ④	8006④
91-95	8	7.4L	To 8600 lbs GVW	9184 ③	8007③
91-95	8	7.4L	Models w/Rear Conv. behind muffler, to 8600 lbs GVW	9186 ③	8007③
91-95	8	7.4L	To 11000 lbs GVW	10903 ③	10907③
91-95	8	7.4L	Models w/Rear Conv. behind muffler, to 11000 lbs GVW	--	10907③
06-07	8	8.1L	Right	--	2587③○
06-07	8	8.1L	Left	--	2587③○
03-06	8	8.1L	2500 HD, California Emissions, Right	9878 ⑤	--
01-06	8	8.1L	2500 HD, 143.5", 153", 157.5", 167" WB, Federal Emissions, Right Side, OE System is completely welded. Additional sizing, bushings, cutting may be required.	9222 ④	--
01-06	8	8.1L	2500 HD, 143.5", 153", 157.5", 167" WB, Federal Emissions, Left Side, OE System is completely welded. Additional sizing, bushings, cutting may be required.	9223 ④	--
01-06	8	8.1L	2500 HD, 133" WB, Federal Emissions, Right Side, OE System is completely welded. Additional sizing, bushings, cutting may be required.	9990 ④	--

- ③ Federal & California Emissions. Not For Sale or Use on vehicles licensed in the state of CA & NY (NY vehicles with CA Emissions). Check with your state authority for details.
- ④ Federal Emissions. Not For Sale or Use on vehicles licensed in the state of CA. Check with your state authority.
- ⑤ California Emissions. Not For Sale or Use on vehicles licensed in the state of CA & NY. Check with your state authority.
- EPA Enhanced OBDII By Design Unit



YR/YRS	CYL	LITER	DESCRIPTION	DIRECT FIT	UNIVERSAL
<b>CHEVROLET C-(2WD), K-(4WD) PICKUP 3/4 TON, (Inc. SILVERADO &amp; AVALANCHE) (Cont.)</b>					
01-06	8	8.1L	2500 HD, 133" WB, Federal Emissions, Left Side, OE System is completely welded. Additional sizing, bushings, cutting may be required.	9223 ④ -- --	-- -- --
2001	8	8.1L	Right, California Emissions	--	8007⑤
2001	8	8.1L	Left, California Emissions	--	8007⑤
75-82	8	All	All	9002 ③	9006③
<b>CHEVROLET C-(2WD), K-(4WD) PICKUP 1 TON, (Inc. SILVERADO)</b>					
96-00	8	5.7L	8600 lbs GVW and Over, Front	9092 ③	2517③
96-00	8	5.7L	8600 lbs GVW and Over, 155.5" W.B., Rear	9293 ②③	2517③
96-99	8	5.7L	8600 lbs GVW and Over, 141.5" W.B., Rear	9093 ③	2517③
96-99	8	5.7L	8600 lbs GVW and Over, 131.5" W.B., Rear	9192 ③	2517③
96-97	8	5.7L	Rear	--	2516③
96-97	8	5.7L	Front	--	2516③
1986	8	5.7L	To 9000 lbs GVW	9529 ③	8006③
11-13	8	6.0L	3500 HD, w/o Third Converter	9545 ③	--
07-09	8	6.0L	3500 HD	9873 ③	--
06-08	8	6.0L	Right	--	2587③○
06-08	8	6.0L	Left	--	2587③○
04-06	8	6.0L	133" WB, Federal Emissions, Exc. HD Series and Cab-Chassis Models, Right Side, OE System is completely welded. Additional sizing, bushings, cutting may be required.	9990 ④ -- --	-- -- --
04-06	8	6.0L	157.5" & 167" WB, Federal Emissions, Exc. HD Series and Cab-Chassis Models, Right Side, OE System is completely welded. Additional sizing, bushings, cutting may be required.	9222 ④ -- --	-- -- --
04-06	8	6.0L	133", 157.5" & 167" WB, Federal Emissions, Exc. HD Series and Cab-Chassis Models, Left Side, OE System is completely welded. Additional sizing, bushings, cutting may be required.	9223 ④ -- --	-- -- --
03-06	8	6.0L	California Emissions, Right	9878 ⑤	--
03-06	8	6.0L	California Emissions, Left	9877 ⑤	--
01-02	8	6.0L	Federal Emissions	--	10907④
01-02	8	6.0L	Right, California Emissions	--	8007⑤
01-02	8	6.0L	Left, California Emissions	--	8007⑤
96-00	8	7.4L	Front, Federal Emissions	9703 ④	8006④
96-00	8	7.4L	Rear, Federal Emissions	--	8006④
96-00	8	7.4L	159.5" W.B., 15000 lbs GVW, Rear	9543 ③	--
06-07	8	8.1L	Right	--	2587③○
06-07	8	8.1L	Left	--	2587③○
04-06	8	8.1L	133" WB, Federal Emissions, Exc. HD Series and Cab-Chassis Models, Right Side, OE System is completely welded. Additional sizing, bushings, cutting may be required.	9990 ④ -- --	-- -- --
04-06	8	8.1L	157.5" & 167" WB, Federal Emissions, Exc. HD Series and Cab-Chassis Models, Right Side, OE System is completely welded. Additional sizing, bushings, cutting may be required.	9222 ④ -- --	-- -- --
04-06	8	8.1L	133", 157.5" & 167" WB, Federal Emissions, Exc. HD Series and Cab-Chassis Models, Left Side, OE System is completely welded. Additional sizing, bushings, cutting may be required.	9223 ④ -- --	-- -- --
03-06	8	8.1L	California Emissions, Right	9878 ⑤	--

② When using with aftermarket piping, direct fit converter may require INLET/OUTLET pipe resizing.

③ Federal & California Emissions. Not For Sale or Use on vehicles licensed in the state of CA & NY (NY vehicles with CA Emissions). Check with your state authority for details.

④ Federal Emissions. Not For Sale or Use on vehicles licensed in the state of CA. Check with your state authority.

⑤ California Emissions. Not For Sale or Use on vehicles licensed in the state of CA & NY. Check with your state authority.

○ EPA Enhanced OBDII By Design Unit

**APPLICATION LISTINGS  
FEDERAL CONVERTERS**



YR/YRS	CYL	LITER	DESCRIPTION	DIRECT FIT	UNIVERSAL
<b>CHEVROLET C-(2WD), K-(4WD) PICKUP 1 TON, (Inc. SILVERADO) (Cont.)</b>					
03-06	8	8.1L	California Emissions, Left	9877 ⑤	--
2001	8	8.1L	Right, California Emissions	--	8007⑤
2001	8	8.1L	Left, California Emissions	--	8007⑤
93-95	8	All	To 12000 lbs GVW	10903 ③	10907③
93-95	8	All	Models w/Rear Conv. behind muffler, To 12000 lbs GVW	--	10907③
93-95	8	All	To 9000 lbs GVW	9184 ③	8007③
93-95	8	All	Models w/Rear Conv., To 9000 lbs GVW, 7.4L	9186 ③	8007③
88-92	8	All	To 12000 lbs GVW	10903 ③	10907③
88-92	8	All	Models w/Rear Conv. behind muffler, To 12000 lbs GVW	--	10907③
88-92	8	All	To 9000 lbs GVW	9184 ③	8007③
88-92	8	All	Models w/Rear Conv., To 9000 lbs GVW, 7.4L	9186 ③	8007③
<b>CHEVROLET C4500 KODIAK</b>					
03-09	8	8.1L	Front	9869 ③	--
03-09	8	8.1L	Rear	9870 ③	--
<b>CHEVROLET CAMARO</b>					
82-85	4	2.5L		--	6004③
1982	6	2.8L		--	6004③
93-95	6	3.4L		4517 ③	6906③
10-11	6	3.6L	Left	5224 ③	--
10-11	6	3.6L	Right	5225 ③	--
00-02	6	3.8L		4278 ③	2516③
95-99	6	3.8L		4884 ③	2540③
1981	6	3.8L	229 C.I.D.	4111 ☆③	6005③
1981	6	3.8L	231 C.I.D.	4111 ☆③	6005③
1980	6	3.8L	229 C.I.D.	--	6905③
1980	6	3.8L	231 C.I.D.	--	6005③
75-79	6	4.1L		--	6905③
83-92	6	All		4115 ☆③	6005③
1980	8	4.4L	Angled Conv.	4111 ☆③	6005③
1980	8	4.4L	Straight Conv.	4119 ☆③	6005③
90-92	8	5.0L	Code "E" & "F", (Exc. Dual Conv. System & 2 3/4" Ext. Pipe)	4115 ☆③	6005③
89-92	8	5.0L	Code "F", Left, Dual Conv. System, Additional sizing, bushings, cutting may be required due to OE exhaust design.	--	2905③
89-92	8	5.0L	Code "F", Right, Dual Conv. System, Additional sizing, bushings, cutting may be required due to OE exhaust design.	--	2905③
89-92	8	5.0L	Code "F", Complete, Dual Conv. System	--	2905③
86-89	8	5.0L	Code "F" & "G", (Exc. Dual Conv. System)	9118 ☆③	9007③
83-89	8	5.0L	Code "E" & "H"	4115 ☆③	6005③
84-85	8	5.0L	Code "F" & "G"	4116 ☆③	6006③
1983	8	5.0L	Code "7"	4116 ☆③	6006③
1983	8	5.0L	Code "S"	4115 ☆③	6005③
1982	8	5.0L	Code "7"	4115 ☆③	6005③
1982	8	5.0L	Code "H", Angled Conv.	--	2905③
1982	8	5.0L	Code "H", Straight Conv.	--	2905③
76-79	8	5.0L		--	6905③
00-02	8	5.7L	Right	9106 ③	--
00-02	8	5.7L	Left	9107 ③	--

☆ Air Tube kit 4948 may be required for installation.

③ Federal & California Emissions. Not For Sale or Use on vehicles licensed in the state of CA & NY (NY vehicles with CA Emissions). Check with your state authority for details.

⑤ California Emissions. Not For Sale or Use on vehicles licensed in the state of CA & NY. Check with your state authority.

YR/YRS	CYL	LITER	DESCRIPTION	DIRECT FIT	UNIVERSAL
<b>CHEVROLET CAMARO (Cont.)</b>					
98-99	8	5.7L	Right	9033 ③	--
98-99	8	5.7L	Left	9034 ③	--
96-97	8	5.7L		9062 ③	2516③
96-97	8	5.7L	Front	9162 ③	--
1995	8	5.7L	Federal Emissions	9069 ④	2907④
1995	8	5.7L	Rear, California Emissions	9062 ⑤	8006⑤
1995	8	5.7L	Front, California Emissions	9162 ⑤	--
93-94	8	5.7L		9069 ③	2907③
90-92	8	5.7L	(Exc. Dual Conv. System)	9133 ☆③	2905③
89-92	8	5.7L	Code "8", Left, Dual Conv. System, Additional sizing, bushings, cutting may be required due to OE exhaust design.	--	2905③
89-92	8	5.7L	Code "8", Right, Dual Conv. System, Additional sizing, bushings, cutting may be required due to OE exhaust design.	--	2905③
89-92	8	5.7L	Code "8", Complete, Dual Conv. System	--	2905③
87-89	8	5.7L	(Exc. Dual Conv. System)	9118 ☆③	9007③
1981	8	5.7L	(Exc. Z28)	--	2905③
1981	8	5.7L	Z28 Models	--	8005③
75-76	8	5.7L		--	8005③
1981	8	All	(Exc. 5.7L)	4111 ☆③	6005③
1980	8	All	(Exc. 267 C.I.D.)	--	6006③
77-79	8	All	Z28 Models	--	8005③
77-79	8	All	(Exc. Z28)	--	8005③
<b>CHEVROLET CAVALIER</b>					
1982	4	1.8L		--	6003③
87-89	4	2.0L	Additional sizing, bushings, cutting may be required due to OE exhaust design.	4117 ②③	6904③
83-86	4	2.0L		--	6003③
03-05	4	2.2L		4205 ③	2504R③
2002	4	2.2L	Code "F" Eng.	4205 ③	2504R③
2002	4	2.2L	Code "4" Eng.	4864 ③	2504R③
99-01	4	2.2L		4864 ③	2504R③
96-98	4	2.2L		4648 ③	2504③
90-95	4	2.2L		4414 ③	6904③
90-95	4	2.2L	Optional Direct Fit Converter	--	6904③
99-02	4	2.4L		4877 ③	2504R③
96-98	4	2.4L		4107 ③	2504R③
87-89	6	2.8L	Z24 Models	--	6907③
87-89	6	2.8L	(Exc. Z24 Models), Additional sizing, bushings, cutting may be required due to OE exhaust design.	4117 ②③	6904③
85-86	6	2.8L		--	6904③
90-94	6	3.1L	2" Conv. Outlet Pipe, Additional sizing, bushings, cutting may be required due to OE exhaust design.	4117 ②③	6904③
1990	6	3.1L	3" Conv. Outlet Pipe	--	6007③
<b>CHEVROLET CELEBRITY</b>					
86-90	4	2.5L	Conv.w/o Front Pipe, w/Air Tube	4155 ☆②③	6004③
86-90	4	2.5L	Conv. w/Front Pipe, w/o Air Tube	4076 ③	6904③
82-85	4	2.5L		--	6004③

☆ Air Tube kit 4948 may be required for installation.

② When using with aftermarket piping, direct fit converter may require INLET/OUTLET pipe resizing.

③ Federal & California Emissions. Not For Sale or Use on vehicles licensed in the state of CA & NY (NY vehicles with CA Emissions). Check with your state authority for details.

④ Federal Emissions. Not For Sale or Use on vehicles licensed in the state of CA. Check with your state authority.

76 ⑤ California Emissions. Not For Sale or Use on vehicles licensed in the state of CA & NY. Check with your state authority.

**APPLICATION LISTINGS**  
**FEDERAL CONVERTERS**



YR/YRS	CYL	LITER	DESCRIPTION	DIRECT FIT	UNIVERSAL
<b>CHEVROLET CELEBRITY (Cont.)</b>					
82-85	6	2.8L		--	6004③
86-90	6	All	Conv. Only	4155 ☆②③	6004③
86-89	6	All	Conv. w/Front Pipe	--	6004③
<b>CHEVROLET CHEVETTE</b>					
81-87	4	1.6L		--	6004③
76-80	4	All		--	6905③
<b>CHEVROLET CITATION</b>					
82-85	4	2.5L		--	6004③
1981	4	2.5L		--	6003③
1980	4	2.5L		--	6904③
83-85	6	2.8L	Code "W" "X" "Z" Eng.	--	6004③
1982	6	2.8L	(Exc. Code "Z" Eng.)	--	6004③
1982	6	2.8L	Code "Z" Eng.	4303 ☆③	6005③
1981	6	2.8L	X-11 Models	--	6005③
1981	6	2.8L	(Exc. X-11 Models)	--	6003③
1980	6	2.8L		--	6904③
<b>CHEVROLET COBALT</b>					
05-07	4	2.0L		4705 ③	--
09-10	4	2.2L	Auto Trans.	4284 ③	2565R③
2009	4	2.2L		--	2565R③
2008	4	2.2L	Auto Trans., Exc. PZEV California Emissions	4284 ③	2565R③
06-07	4	2.2L	Auto Trans., Federal Emissions	4015 ④	2564R③○
			Auto Trans., Federal Emissions	--	2505R③□
2005	4	2.2L	Auto Trans.	4015 ③	2564R③○
			Auto Trans.	--	2505R③□
2008	4	2.4L	Auto Trans.	4284 ③	2565R③
06-07	4	2.4L	Auto Trans.	4015 ③	2564R③○
			Auto Trans.	--	2505R③□
<b>CHEVROLET COLORADO</b>					
04-06	4	2.8L	Front	1216 ③	--
04-06	4	2.8L		9216 ③	2575R③
07-12	4	2.9L		1227 ③	--
04-06	5	3.5L	Front	4487 ③	--
04-06	5	3.5L		9216 ③	2575R③
07-12	5	3.7L	Manifold Unit, Front	1226 ③	--
09-12	8	5.3L	Left	9549 ③	--
09-12	8	5.3L	Right	9550 ③	--
<b>CHEVROLET CORSICA</b>					
1996	4	2.2L		4817 ③	2504③
93-95	4	2.2L		4414 ③	6004③
93-95	4	2.2L	Optional Direct Fit Converter	--	6004③
87-92	4	All	Additional sizing, bushings, cutting may be required due to OE exhaust design.	4306 ☆③	6004③
				--	--
1996	6	3.1L		4862 ③	2504R③
94-95	6	3.1L	Conv. w/Front Pipe	4793 ③	6904R③
1993	6	3.1L	Additional sizing, bushings, cutting may be required due to OE exhaust design.	4117 ②③	6904③
				--	--

☆ Air Tube kit 4948 may be required for installation.

② When using with aftermarket piping, direct fit converter may require INLET/OUTLET pipe resizing.

③ Federal & California Emissions. Not For Sale or Use on vehicles licensed in the state of CA & NY (NY vehicles with CA Emissions). Check with your state authority for details.

④ Federal Emissions. Not For Sale or Use on vehicles licensed in the state of CA. Check with your state authority.

□ EPA OBDII By Design Unit

○ EPA Enhanced OBDII By Design Unit

YR/YRS	CYL	LITER	DESCRIPTION	DIRECT FIT	UNIVERSAL
<b>CHEVROLET CORSICA (Cont.)</b>					
87-92	6	All	Additional sizing, bushings, cutting may be required due to OE exhaust design.	4306 ☆③ --	6904③ --
<b>CHEVROLET CORVETTE</b>					
00-04	8	5.7L	Federal Emissions	9187 ④	2516④
00-04	8	5.7L	California Emissions	9203 ⑤	2516⑤
97-99	8	5.7L		9032 ③	--
92-96	8	5.7L	Code "P", Right	9130 ③	8007③
92-96	8	5.7L	Code "P", Left	9131 ③	8007③
1995	8	5.7L	Right	--	8007③
1995	8	5.7L	Left	--	8007③
86-91	8	5.7L	Y-Pipe Pre Cats	1010 ③	6905R③
86-91	8	5.7L	Main Conv., (Exc. ZR1)	9118 ☆③	9007③
86-91	8	5.7L	Main Plus Pre Cat Eliminator	9518 ☆③	9007③
84-85	8	5.7L		--	2906③
81-82	8	5.7L		--	8005③
76-80	8	All		--	8005③
1975	8	All		--	8005③
<b>CHEVROLET CRUZE</b>					
11-15	4	1.4L	Rear	5026 ③	--
11-14	4	1.8L	Manifold Unit, Front	1349 ③	--
<b>CHEVROLET EL CAMINO</b>					
1984	6	3.8L	231 C.I.D.	4112 ☆③	6005③
83-84	6	3.8L	229 C.I.D.	4115 ☆③	6005③
81-83	6	3.8L	231 C.I.D.	4111 ☆③	6005③
81-82	6	3.8L	229 C.I.D.	4111 ☆③	6005③
1980	6	3.8L	229 C.I.D., Angled Conv.	4111 ☆③	6005③
1980	6	3.8L	229 C.I.D., Straight Conv.	4019 ③	6905③
1980	6	3.8L	231 C.I.D.	--	6006③
75-77	6	4.1L		--	6906③
85-87	6	4.3L		4303 ☆③	6005③
78-79	6	All		4111 ☆③	6005③
1979	8	4.4L	267 C.I.D.	4111 ☆③	6005③
1979	8	5.0L		--	6906③
1978	8	5.0L		4111 ☆③	6005③
76-77	8	5.0L		--	6906③
78-79	8	5.7L		--	6906③
75-77	8	5.7L		--	6906③
75-76	8	6.6L		--	8006③
1975	8	7.4L		--	8006③
83-87	8	All		4115 ☆③	6005③
81-82	8	All		4111 ☆③	6005③
1980	8	All		--	6006③
<b>CHEVROLET EQUINOX</b>					
10-15	4	2.4L	Rear	4012 ③	2576③
10-15	4	2.4L	Front	5221 ③	--
2012	6	3.0L	Front Left	1350 ③	--
10-12	6	3.0L	Rear Conv.	4692 ③	2576③

☆ Air Tube kit 4948 may be required for installation.

③ Federal & California Emissions. Not For Sale or Use on vehicles licensed in the state of CA & NY (NY vehicles with CA Emissions). Check with your state authority for details.

④ Federal Emissions. Not For Sale or Use on vehicles licensed in the state of CA. Check with your state authority.

⑤ California Emissions. Not For Sale or Use on vehicles licensed in the state of CA & NY. Check with your state authority.

**APPLICATION LISTINGS  
FEDERAL CONVERTERS**



YR/YRS	CYL	LITER	DESCRIPTION	DIRECT FIT	UNIVERSAL
<b>CHEVROLET EQUINOX (Cont.)</b>					
10-11	6	3.0L	Front Left	1206 ③	--
10-11	6	3.0L	Front Right	1207 ③	--
05-09	6	3.4L		4357 ③	2516 ③
13-15	6	3.6L	Front Left	1350 ③	--
08-09	6	3.6L	Front Conv.	4444 ③	2575 ③
08-09	6	3.6L	Rear Conv.	4445 ③	2575 ③
<b>CHEVROLET FULL SIZE (Inc. Impala RWD, Caprice, Belair, Police, Taxi, Station Wagon)</b>					
1984	6	3.8L	231 C.I.D.	4112 ☆③	6005 ③
83-84	6	3.8L	229 C.I.D.	4115 ☆③	6005 ③
1983	6	3.8L	231 C.I.D., California Emissions	4111 ☆⑤	6005 ⑤
1983	6	3.8L	231 C.I.D., Federal Emissions	4112 ☆④	6005 ④
77-79	6	4.1L		--	6906 ③
92-93	6	4.3L		4115 ☆③	6005 ③
85-90	6	4.3L	w/Air Tube	4303 ☆③	6005 ③
80-82	6	All	w/2-1/4" Angled Conv.	--	6005 ③
80-82	6	All	w/2-1/4" Straight Conv.	--	6005 ③
1980	6	All	w/2-1/2" Angled Conv.	--	6906 ③
91-93	8	5.0L	(Exc. Taxi & Station Wgn.)	4115 ☆③	6005 ③
91-93	8	5.0L	Taxi & Station Wgn.	9133 ☆③	2905 ③
88-90	8	5.0L	(Exc. Taxi & Station Wgn.)	4115 ☆③	6005 ③
88-90	8	5.0L	Taxi	9133 ☆③	2905 ③
88-90	8	5.0L	Station Wgn.	--	2905 ③
83-88	8	5.0L	Code "H"	4115 ☆③	6005 ③
92-95	8	5.7L	Police Car, w/GM RPO 9C-1	9118 ☆③	9007 ③
83-90	8	5.7L	(Exc. Taxi & Station Wgn.)	4115 ☆③	6005 ③
83-90	8	5.7L	Taxi & Station Wgn.	9133 ☆③	2905 ③
81-82	8	5.7L		--	2905 ③
1980	8	5.7L		--	6906 ③
75-76	8	5.7L		--	6906 ③
75-76	8	6.6L		--	8006 ③
75-76	8	7.4L		--	8006 ③
94-96	8	All	Left	9404 ③	2515 ③
94-96	8	All	Right	9403 ③	2515 ③
81-82	8	All	(Exc. 5.7L)	4111 ☆③	6005 ③
1980	8	All	(Exc. 5.7L)	--	6006 ③
77-79	8	All		--	6906 ③
<b>CHEVROLET G -VAN 1/2 &amp; 3/4 TON (Inc. Express Van)</b>					
83-84	6	4.1L		4001 ③	6906 ③
75-82	6	4.1L		9002 ③	2906 ③
09-14	6	4.3L	1500	9872 ③	--
07-08	6	4.3L	1500, Right	--	2565R ③
07-08	6	4.3L	1500, Left	--	2565R ③
03-06	6	4.3L	1500, Complete Assembly	9991 ③	2576R ③
03-05	6	4.3L	2500, Complete Assembly	9991 ③	2576R ③
00-02	6	4.3L	Under 8500 lbs GVW, W/2 Bolt Outlet Flange	9019 ③	2517 ③
96-99	6	4.3L	Over 8500 lbs GVW, w/3 Bolt Outlet Flange	9138 ③	2517 ③
96-99	6	4.3L	To 8500 lbs GVW, w/3 Bolt Outlet Flange	9649 ③	2517 ③

☆ Air Tube kit 4948 may be required for installation.

③ Federal & California Emissions. Not For Sale or Use on vehicles licensed in the state of CA & NY (NY vehicles with CA Emissions). Check with your state authority for details.

④ Federal Emissions. Not For Sale or Use on vehicles licensed in the state of CA. Check with your state authority.

⑤ California Emissions. Not For Sale or Use on vehicles licensed in the state of CA & NY. Check with your state authority.

YR/YRS	CYL	LITER	DESCRIPTION	DIRECT FIT	UNIVERSAL
<b>CHEVROLET G -VAN 1/2 &amp; 3/4 TON (Inc. Express Van) (Cont.)</b>					
1995	6	4.3L		9616 ③	2907③
85-94	6	4.3L		9002 ③	2906③
08-13	8	4.8L	2500, Cutaway & Stripped Chassis, Left	9876 ③	--
10-11	8	4.8L	2500, Y-Pipe Unit, Exc. Cutaway & Stripped Chassis	9872 ③	--
06-10	8	4.8L	2500, Standard Passenger Van, Standard Cargo Van, Extended Cargo Van, California Emissions, Left	9874 ⑤	--
06-10	8	4.8L	2500, Standard Passenger Van, Standard Cargo Van, Extended Cargo Van, California Emissions, Right	--	--
06-09	8	4.8L	2500, Left, Federal Emissions, Body to Front	9875 ⑤	--
06-09	8	4.8L	2500, Right, Federal Emissions, Body to Front	--	--
06-09	8	4.8L	2500, Left, Federal Emissions, Body to Front	9995 ④	2577④
06-09	8	4.8L	2500, Right, Federal Emissions, Body to Front	9994 ④	2577④
03-05	8	4.8L	2500, Right Conv. 68-1/4", Federal Emissions	9208 ④	2517④
03-05	8	4.8L	2500, Right Conv. 60-3/4", Federal Emissions	9188 ④	2517④
03-05	8	4.8L	2500, Left, Federal Emissions	9189 ④	2517④
03-05	8	4.8L	2500, 2 Bodies, Left, California Emissions	9992 ⑤	--
03-05	8	4.8L	2500, 2 Bodies, Right, California Emissions	9993 ⑤	--
00-02	8	5.0L	Under 8500 lbs GVW	9019 ③	2517③
96-99	8	5.0L	w/3 Bolt Outlet Flange	9649 ③	2517③
1995	8	5.0L	(Exc. 146" W.B.)	9616 ③	2907③
87-94	8	5.0L		9002 ③	2906③
09-14	8	5.3L	1500	9872 ③	--
03-05	8	5.3L	1500 & 2500, Complete Assembly	9991 ③	2576R③
2002	8	5.7L	1500, Under 8500 lbs GVW, Complete Assembly	9278 ③	--
2002	8	5.7L	1500, Under 8500 lbs GVW, Right	--	2505R③
2002	8	5.7L	1500, Under 8500 lbs GVW, Left	--	2505R③
01-02	8	5.7L	1500 & 2500, Over 8500 lbs GVW, Left	9916 ③	--
01-02	8	5.7L	1500 & 2500, Over 8500 lbs GVW, Right	9917 ③	--
00-02	8	5.7L	2500, Under 8500 lbs GVW	9880 ③	--
2000	8	5.7L	2500, Under 8500 lbs GVW, Right	--	2517③
2000	8	5.7L	2500, Under 8500 lbs GVW, Left	--	2517③
2000	8	5.7L	1500, Under 8500 lbs GVW	9880 ③	--
97-00	8	5.7L	2500 Over 8500 lbs GVW, Right	9080 ③	2517③
97-00	8	5.7L	2500 Over 8500 lbs GVW, Left	9081 ③	2517③
96-99	8	5.7L	Single Conv. System, W/3 Bolt Outlet Flange	9649 ③	2517③
96-99	8	5.7L	Dual Conv. System, Under 8500 lbs GVW, Right	9042 ③	2517③
96-99	8	5.7L	Dual Conv. System, Under 8500 lbs GVW, Left	9043 ③	2517③
1995	8	5.7L	2500, (Exc. 146" W.B.)	9616 ③	2907③
92-94	8	5.7L	Over 9000 lbs GVW	10903 ③	10907③
92-94	8	5.7L	Models w/Rear Conv. behind muffler, Over 9000 lbs GVW	--	10907③
92-94	8	5.7L	To 9000 lbs GVW	9184 ③	8007③
92-94	8	5.7L	Models w/Rear Conv. behind muffler, To 9000 lbs GVW	9186 ③	8007③
87-91	8	5.7L	Over 9000 lbs GVW	10903 ③	10907③
87-91	8	5.7L	Models w/Rear Conv. behind muffler, Over 9000 lbs GVW	--	10907③
87-91	8	5.7L	To 9000 lbs GVW	9184 ③	8007③
87-91	8	5.7L	Models w/Rear Conv., To 9000 lbs GVW	9186 ③	8007③
75-76	8	5.7L	w/Conv.	4001 ③	6906③
08-13	8	6.0L	2500, Cutaway & Stripped Chassis, Left	9876 ③	--
11-12	8	6.0L	2500, Complete Assembly	9279 ③	--

③ Federal & California Emissions. Not For Sale or Use on vehicles licensed in the state of CA & NY (NY vehicles with CA Emissions). Check with your state authority for details.

④ Federal Emissions. Not For Sale or Use on vehicles licensed in the state of CA. Check with your state authority.

⑤ California Emissions. Not For Sale or Use on vehicles licensed in the state of CA & NY. Check with your state authority.

**APPLICATION LISTINGS  
FEDERAL CONVERTERS**



YR/YRS	CYL	LITER	DESCRIPTION	DIRECT FIT	UNIVERSAL
<b>CHEVROLET G -VAN 1/2 &amp; 3/4 TON (Inc. Express Van) (Cont.)</b>					
10-11	8	6.0L	2500, Y-Pipe Unit, Exc. Cutaway & Stripped Chassis	9872 ③	--
06-10	8	6.0L	2500, Standard Passenger Van, Standard Cargo Van, Extended Cargo Van, California Emissions, Left	9874 ⑤	--
06-10	8	6.0L	2500, Standard Passenger Van, Standard Cargo Van, Extended Cargo Van, California Emissions, Right	9875 ⑤	--
06-09	8	6.0L	2500, Left, Federal Emissions, Body to Front	9995 ④	2577④
06-09	8	6.0L	2500, Right, Federal Emissions, Body to Front	9994 ④	2577④
03-05	8	6.0L	2500, Right Conv. 68-1/4", Federal Emissions	9208 ④	2517④
03-05	8	6.0L	2500, Right Conv. 60-3/4", Federal Emissions	9188 ④	2517④
03-05	8	6.0L	2500, Left, Federal Emissions	9189 ④	2517④
03-05	8	6.0L	2500, 2 Bodies, Left, California Emissions	9992 ⑤	--
03-05	8	6.0L	2500, 2 Bodies, Right, California Emissions	9993 ⑤	--
79-80	8	6.6L		9002 ③	8006③
83-86	8	All		9002 ③	8006③
79-82	8	All	(Exc. 400 C.I.D.)	4001 ③	6906③
<b>CHEVROLET G -VAN 1 TON (Inc. Express Van)</b>					
1995	6	4.3L		--	2907③
91-94	6	4.3L	To 8500 lbs GVW	9002 ③	2906③
91-94	6	4.3L	Over 8500 lbs GVW	--	10906③
78-90	6	All	To 8500 lbs GVW	9002 ③	8006③
08-13	8	4.8L	Cutaway & Stripped Chassis, Left	9876 ③	--
10-11	8	4.8L	Y-Pipe Unit, Exc. Cutaway & Stripped Chassis	9872 ③	--
06-10	8	4.8L	Standard Passenger Van, Standard Cargo Van, Extended Cargo Van, California Emissions, Left	9874 ⑤	--
06-10	8	4.8L	Standard Passenger Van, Standard Cargo Van, Extended Cargo Van, California Emissions, Right	9875 ⑤	--
01-02	8	5.7L	Over 8500 lbs GVW, Left	9916 ③	--
01-02	8	5.7L	Over 8500 lbs GVW, Right	9917 ③	--
00-02	8	5.7L	Under 8500 lbs GVW	9880 ③	--
2000	8	5.7L	Under 8500 lbs GVW	--	2517③
97-00	8	5.7L	135" & 155" W.B. Over 8500 lbs GVW, Right	9080 ③	2517③
97-00	8	5.7L	135" & 155" W.B. Over 8500 lbs GVW, Left	9081 ③	2517③
1996	8	5.7L	Under 8500 lbs GVW, Right	9042 ③	2517③
1996	8	5.7L	Under 8500 lbs GVW, Left	9043 ③	2517③
1996	8	5.7L	135" & 155" W.B. Over 8500 lbs GVW, Right	9080 ③	2517③
1996	8	5.7L	135" & 155" W.B. Over 8500 lbs GVW, Left	9081 ③	2517③
1995	8	5.7L	Under 9000 lbs GVW	--	8007③
87-91	8	5.7L	Under 9000 lbs GVW	9184 ③	8007③
87-91	8	5.7L	Models w/Rear Conv. behind muffler, Under 9000 lbs GVW	9186 ③	8007③
87-91	8	5.7L	Over 9000 lbs GVW	10903 ③	10907③
87-91	8	5.7L	Models w/Rear Conv. behind muffler, Over 9000 lbs GVW	--	10907③
80-86	8	5.7L		9002 ③	8006③
08-13	8	6.0L	Cutaway & Stripped Chassis, Left	9876 ③	--
11-12	8	6.0L	135" and 155" W.B., Complete Assembly	9279 ③	--
10-11	8	6.0L	Y-Pipe Unit, Exc. Cutaway & Stripped Chassis	9872 ③	--
06-10	8	6.0L	Standard Passenger Van, Standard Cargo Van, Extended Passenger Van, Extended Cargo Van, California Emissions, Left	9874 ⑤	--

③ Federal & California Emissions. Not For Sale or Use on vehicles licensed in the state of CA & NY (NY vehicles with CA Emissions). Check with your state authority for details.

④ Federal Emissions. Not For Sale or Use on vehicles licensed in the state of CA. Check with your state authority.

⑤ California Emissions. Not For Sale or Use on vehicles licensed in the state of CA & NY. Check with your state authority.



YR/YRS	CYL	LITER	DESCRIPTION	DIRECT FIT	UNIVERSAL
<b>CHEVROLET G -VAN 1 TON (Inc. Express Van) (Cont.)</b>					
06-10	8	6.0L	Standard Passenger Van, Standard Cargo Van, Extended Passenger Van, Extended Cargo Van, California Emissions, Right	9875 ⑤ --	-- --
06-09	8	6.0L	Left, Federal Emissions, Body to Front	9995 ④	2577④
06-09	8	6.0L	Right, Federal Emissions, Body to Front	9994 ④	2577④
03-05	8	6.0L	Right, 60-3/4", Federal Emissions	9188 ④	2517④
03-05	8	6.0L	Right, 68-1/4", Federal Emissions	9208 ④	2517④
03-05	8	6.0L	Left, Federal Emissions	9189 ④	2517④
03-05	8	6.0L	2 Bodies, Left, California Emissions	9992 ⑤	--
03-05	8	6.0L	2 Bodies, Right, California Emissions	9993 ⑤	--
1995	8	7.4L	Under 9000 lbs GVW	--	8007③
92-94	8	All	Under 9000 lbs GVW	9184 ③	8007③
92-94	8	All	Over 9000 lbs GVW	10903 ③	10907③
78-79	8	All	w/Conv.	9002 ③	8006③
<b>CHEVROLET HHR</b>					
08-11	4	2.2L	Auto Trans.	4284 ③	2565R③
06-07	4	2.2L	Auto Trans. Auto Trans.	4015 ③ --	2564R③○ 2505R③□
08-11	4	2.4L	Auto Trans.	4284 ③	2565R③
2008	4	2.4L	Auto Trans.	4621 ③⑩	--
06-07	4	2.4L	Auto Trans. Auto Trans.	4015 ③ --	2564R③○ 2505R③□
<b>CHEVROLET IMPALA FWD</b>					
00-05	6	3.4L		4850 ③	2506R③
2009	6	3.5L	Gas, Calif. Emissions (LEV2 Spec.)	4376 ⑤	2565⑤
06-09	6	3.5L	Flex Fuel	4376 ③	2565③
06-08	6	3.5L	Gas	4376 ③	2565③
12-13	6	3.6L	Exc. PZEV Spec, Rear	4931 ③	2566R③
12-13	6	3.6L	Front Left	1347 ③	--
12-13	6	3.6L	Front Right	1348 ③	--
04-05	6	3.8L	Supercharged Supercharged	4876 ③ --	2576R③○ 2506R③□
00-05	6	3.8L	Code "K" Eng. Code "K" Eng.	4876 ③ --	2576R③○ 2506R③□
10-11	6	3.9L	Center	5223 ③	--
08-09	6	3.9L	Flex Fuel	4376 ③	2565③
06-07	6	3.9L	Gas	4376 ③	2565③
06-09	8	5.3L	SS	4531 ③	--
<b>CHEVROLET LAGUNA</b>					
75-76	8	6.6L	400 C.I.D.	--	8006③
75-76	8	All	(Exc. 400 C.I.D.)	--	6906③
<b>CHEVROLET LLV</b>					
94-95	4	2.2L		4623 ③	6905③
87-93	4	2.5L		4019 ③	6905③

- ⑩ Discontinued, use until inventory is depleted.
- ③ Federal & California Emissions. Not For Sale or Use on vehicles licensed in the state of CA & NY (NY vehicles with CA Emissions). Check with your state authority for details.
- ④ Federal Emissions. Not For Sale or Use on vehicles licensed in the state of CA. Check with your state authority.
- ⑤ California Emissions. Not For Sale or Use on vehicles licensed in the state of CA & NY. Check with your state authority.
- EPA OBDII By Design Unit
- EPA Enhanced OBDII By Design Unit

**APPLICATION LISTINGS  
FEDERAL CONVERTERS**



YR/YRS	CYL	LITER	DESCRIPTION	DIRECT FIT	UNIVERSAL
<b>CHEVROLET LUMINA</b>					
90-92	4	2.5L	For use with OE intermediate pipe, additional sizing, bushings, cutting may be required due to OE exhaust design, # 6 bushing may be required at inlet & # 8 bushing may be required at outlet for use w/aftermarket pipe.	4137 ②③ -- -- --	6905③ -- -- --
90-92	4	2.5L	For use with 2-1/8" I.D. aftermarket intermediate pipe, additional sizing, bushings, cutting may be required due to OE exhaust design.	4137G ②③ --	6905③ --
1993	4	All		--	6905③
97-01	6	3.1L		4874 ③	2504R③
95-96	6	3.1L	w/Post Conv. O2 Sensor	4838 ③	2505R③
94-95	6	3.1L	(Exc. w/Post Conv. O2 Sensor), 1994 small outlet flange distance between bottom holes in intermediate pipe is 2-11/16" center to center.	4629 ③ -- --	6904R③ -- --
1994	6	3.1L	With large outlet flange, distance between bottom holes in intermediate pipe is 3-3/16" center to center.	4141 ③ --	2904③ --
1993	6	3.1L	California Emissions, (Exc. Methanol Fueled Vehicle)	--	6905⑤
1993	6	3.1L	Federal Emissions, (Exc. Methanol Fueled Vehicle), For use with OE intermediate pipe, additional sizing, bushings, cutting may be required due to OE exhaust design, # 6 bushing may be required at inlet & # 8 bushing may be required at outlet for use w/af	4137 ②④ -- -- --	6905④ -- -- --
1993	6	3.1L	Federal Emissions, (Exc. Methanol Fueled Vehicle), For use with 2-1/8" I.D. aftermarket intermediate pipe, additional sizing, bushings, cutting may be required due to OE exhaust design.	4137G ②④ -- --	6905④ -- --
90-92	6	3.1L	(Exc. Methanol Fueled Vehicle), For use with OE intermediate pipe, additional sizing, bushings, cutting may be required due to OE exhaust design, # 6 bushing may be required at inlet & # 8 bushing may be required at outlet for use w/aftermarket pipe.	4137 ②③ -- -- --	6905③ -- -- --
90-92	6	3.1L	(Exc. Methanol Fueled Vehicle), For use with 2-1/8" I.D. aftermarket intermediate pipe, additional sizing, bushings, cutting may be required due to OE exhaust design.	4137G ②③ -- --	6905③ -- --
1997	6	3.4L		--	2505R③
1996	6	3.4L		4898 ③	2506R③
91-95	6	3.4L		4779 ③	6906③
98-99	6	3.8L	Federal Emissions	4473 ④	--
98-99	6	3.8L	Federal Emissions, Front	--	2506R④
98-99	6	3.8L	Federal Emissions, Rear	--	2545④
98-99	6	3.8L	California Emissions	4446 ⑤	2506R⑤
<b>CHEVROLET LUMINA APV</b>					
93-95	6	3.1L		4242 ③	2905③
90-92	6	3.1L	Conv., w/Front Pipe	--	2905③
90-92	6	3.1L	Conv. Only	--	2905③
1996	6	3.4L		4781 ③	2516③
93-95	6	3.8L		4873 ③	2905③
<b>CHEVROLET LUV</b>					
76-82	4	1.8L		--	6905③

② When using with aftermarket piping, direct fit converter may require INLET/OUTLET pipe resizing.  
 ③ Federal & California Emissions. Not For Sale or Use on vehicles licensed in the state of CA & NY (NY vehicles with CA Emissions). Check with your state authority for details.  
 ④ Federal Emissions. Not For Sale or Use on vehicles licensed in the state of CA. Check with your state authority.  
 ⑤ California Emissions. Not For Sale or Use on vehicles licensed in the state of CA & NY. Check with your state authority.

YR/YRS	CYL	LITER	DESCRIPTION	DIRECT FIT	UNIVERSAL
<b>CHEVROLET MALIBU</b>					
04-08	4	2.2L	Manifold Unit, Front	4539 ③①	--
			Manifold Unit, Front	1231 ③	--
04-05	4	2.2L	Classic Model	4205 ③	2564R③○
			Classic Model	--	2504R③□
11-12	4	2.4L	Front	5219 ③	--
09-12	4	2.4L	Rear, OE exhaust system is completely welded, additional adapters or sizing and cutting of the OE pipe may be required to complete installation.	4714 ③	--
				--	--
				--	--
08-10	4	2.4L	6 Speeds, Front	5219 ③	--
08-10	4	2.4L	4 Speed, Manifold Unit, Front	4539 ③	--
			4 Speed, Manifold Unit, Front	1231 ③	--
2008	4	2.4L	Rear; LS, LT, LTZ Models; OE exhaust system is completely welded, additional adapters or sizing of the OE pipe may be required to complete installation	4714 ③	--
				--	--
				--	--
1999	4	2.4L		4877 ③	2504R③
97-98	4	2.4L		4107 ③	2505R③
98-03	6	3.1L		4863 ③	2505R③
1997	6	3.1L		--	2505R③
2008	6	3.5L	Classic LS, Classic LT, Front Right	5218 ③	--
2007	6	3.5L	Front Right	5218 ③	--
2007	6	3.5L	Front Conv.	--	2564③○
2007	6	3.5L	Rear Conv.	--	2584③○
05-06	6	3.5L	Front Conv.	4424 ③	2554③
05-06	6	3.5L	Rear Conv.	4425 ③	2538③
2004	6	3.5L	With No Flex Coupling in Pipe, Front Conv.	4574 ③	--
2004	6	3.5L	With No Flex Coupling in Pipe, Rear Conv.	4575 ③	--
08-09	6	3.6L	Rear	--	2574R③○
08-09	6	3.6L	Front	--	2574R③○
2008	6	3.6L	Front	4542 ③	--
2008	6	3.6L	Rear	4543 ③	--
1983	6	3.8L	229 C.I.D.	4115 ☆③	6005③
81-83	6	3.8L	231 C.I.D.	4111 ☆③	6005③
81-82	6	3.8L	229 C.I.D.	4111 ☆③	6005③
1980	6	3.8L	229 C.I.D., Angled Conv.	4111 ☆③	6005③
1980	6	3.8L	229 C.I.D., Straight Conv.	4019 ③	6905③
1980	6	3.8L	231 C.I.D.	--	6006③
2007	6	3.9L	Front Conv.	--	2564③○
2007	6	3.9L	Rear Conv.	--	2584③○
06-07	6	3.9L	Front Right	5218 ③	--
75-77	6	4.1L		--	6906③
78-79	6	All		4111 ☆③	6005③
1979	8	4.4L		4111 ☆③	6005③
1983	8	5.0L	Code "H"	4115 ☆③	6005③
1979	8	5.0L		--	6906③
1978	8	5.0L		--	6005③
76-77	8	5.0L		--	6906③
78-79	8	5.7L		--	6906③

① Discontinued, use until inventory is depleted.

☆ Air Tube kit 4948 may be required for installation.

③ Federal & California Emissions. Not For Sale or Use on vehicles licensed in the state of CA & NY (NY vehicles with CA Emissions). Check with your state authority for details.

□ EPA OBDII By Design Unit

○ EPA Enhanced OBDII By Design Unit

# APPLICATION LISTINGS

## FEDERAL CONVERTERS



YR/YRS	CYL	LITER	DESCRIPTION	DIRECT FIT	UNIVERSAL
<b>CHEVROLET MALIBU (Cont.)</b>					
75-77	8	5.7L		--	6906③
75-76	8	6.6L		--	8006③
1975	8	7.4L		--	8006③
81-82	8	All		4111 ☆③	6005③
1980	8	All		--	6006③
<b>CHEVROLET METRO</b>					
98-00	3	1.0L	51-1/8" Conv., Federal Emissions	4096 ④	2538④
98-01	4	1.3L	Front, California Emissions, Includes Pipe Between Converters	1042 ⑤	--
98-01	4	1.3L	Rear, California Emissions	4342 ⑤	2538⑤
98-00	4	1.3L	51-1/8" Conv., Federal Emissions	4096 ④	2538④
<b>CHEVROLET MONTE CARLO</b>					
97-99	6	3.1L		4874 ③	2504R③
95-96	6	3.1L	w/Post Conv. O2 Sensor	4838 ③	2505R③
1995	6	3.1L	(Exc. Models w/Post Conv. O2 Sensor)	4629 ③	6904R③
00-05	6	3.4L		4850 ③	2506R③
1997	6	3.4L	Z34, DOHC	--	2505R③
1996	6	3.4L	Z34, DOHC	4898 ③	2506R③
1995	6	3.4L		4779 ③	6906③
06-07	6	3.5L		4376 ③	2574R③○
04-05	6	3.8L	Supercharged	4876 ③	2576R③○
			Supercharged	--	2506R③□
00-05	6	3.8L	Code "K" Eng.	4876 ③	2576R③○
			Code "K" Eng.	--	2506R③□
98-99	6	3.8L	Federal Emissions	4473 ④	--
98-99	6	3.8L	Federal Emissions, Front	--	2506R④
98-99	6	3.8L	Federal Emissions, Rear	--	2545④
98-99	6	3.8L	California Emissions	4446 ⑤	2506R⑤
1984	6	3.8L	231 C.I.D.	4112 ☆③	6005③
83-84	6	3.8L	229 C.I.D.	4115 ☆③	6005③
81-83	6	3.8L	231 C.I.D., (Exc. Turbo)	4111 ☆③	6005③
81-82	6	3.8L	229 C.I.D.	4111 ☆③	6005③
1981	6	3.8L	231 C.I.D., Turbo	4112 ☆③	6005③
1980	6	3.8L	229 C.I.D., Angled Conv.	4111 ☆③	6005③
1980	6	3.8L	229 C.I.D., Straight Conv.	4019 ③	6905③
1980	6	3.8L	231 C.I.D.	--	6006③
2006	6	3.9L		4376 ③	2574R③○
85-88	6	4.3L		4303 ☆③	6005③
78-79	6	All		--	6005③
1979	8	4.4L		4111 ☆③	6005③
83-88	8	5.0L	Monte Carlo SS	4116 ☆③	6006③
1979	8	5.0L		--	6906③
1978	8	5.0L		4111 ☆③	6005③
76-77	8	5.0L		--	6906③
06-07	8	5.3L		4531 ③	--
75-77	8	5.7L		--	6906③
75-76	8	6.6L		--	8006③
1975	8	7.4L		--	8006③

☆ Air Tube kit 4948 may be required for installation.

③ Federal & California Emissions. Not For Sale or Use on vehicles licensed in the state of CA & NY (NY vehicles with CA Emissions). Check with your state authority for details.

④ Federal Emissions. Not For Sale or Use on vehicles licensed in the state of CA. Check with your state authority.

⑤ California Emissions. Not For Sale or Use on vehicles licensed in the state of CA & NY. Check with your state authority.

□ EPA OBDII By Design Unit

○ EPA Enhanced OBDII By Design Unit

YR/YRS	CYL	LITER	DESCRIPTION	DIRECT FIT	UNIVERSAL
<b>CHEVROLET MONTE CARLO (Cont.)</b>					
83-88	8	All	(Exc. Monte Carlo SS)	4115 ☆③	6005③
81-82	8	All		4111 ☆③	6005③
1980	8	All		--	6006③
<b>CHEVROLET MONZA</b>					
77-80	4	All		--	6905③
1976	4	All	w/A.I.R.	--	6905③
1976	4	All	(Exc. Models w/A.I.R.)	--	6905③
1975	4	All		--	6905③
1980	6	3.8L		--	6905③
75-79	6,8	All		--	6905③
<b>CHEVROLET NOVA</b>					
1988	4	1.6L	SOHC	4070 ☆③	6004③
1988	4	1.6L	SOHC, California Emissions	--	6004⑤
1988	4	1.6L	DOHC	4377 ③	6904③
85-87	4	1.6L		4070 ☆③	6004③
77-79	6	All	California Emissions	--	6906⑤
77-79	6	All	Federal Emissions	--	6905④
75-76	6	All		--	6905③
75-79	8	All		--	6905③
<b>CHEVROLET P30, P30 SERIES, P30 VAN</b>					
97-99	8	5.7L		9542 ③	--
<b>CHEVROLET PRIZM</b>					
98-02	4	1.8L	DOHC, 4 Dr.	4043 ③	2504R③
<b>CHEVROLET R-(2WD), V-(4WD) PICKUP</b>					
1987	6	4.3L		9002 ③	2906③
1987	8	5.0L		9529 ③	2906③
87-89	8	5.7L	Under 9000 lbs GVW	9184 ③	2907③
87-89	8	7.4L	Over 9000 lbs GVW	10903 ③	10907③
<b>CHEVROLET S-Series (2WD), T-Series (4WD) PICKUP</b>					
82-84	4	1.9L		4019 ③	6905③
83-84	4	2.0L		4019 ③	6905③
96-03	4	2.2L		4819 ③	2506③
94-95	4	2.2L		4623 ③	6905③
85-93	4	2.5L		4019 ③	6905③
88-93	6	2.8L		4088 ③	6906③
82-87	6	2.8L		4019 ③	6905③
01-04	6	4.3L	4WD, 4 Dr., California Emissions	9109 ⑤	--
01-04	6	4.3L	Front, 4WD, 4 Dr., California Emissions	--	2576R⑤
01-04	6	4.3L	Rear, 4WD, 4 Dr., California Emissions	--	2517⑤
01-03	6	4.3L	4WD, 3 Dr. Extended Cab, California Emissions	9110 ⑤	--
01-03	6	4.3L	RWD, Automatic Trans., With One Conv.	9996 ③	2576③
00-02	6	4.3L	RWD, Automatic Trans., With Two Convs., California Emissions	9091 ⑤	--
2000	6	4.3L	2WD	--	2516③
2000	6	4.3L	4WD, Federal Emissions	9227 ④	--
2000	6	4.3L	2WD, Extended Cab, Auto. Trans., Federal Emissions	9228 ④	--
98-99	6	4.3L	2WD & Extended Cab, California Emissions	1177 ⑤	2564R⑤
98-99	6	4.3L	2WD, w/ 31 1/2" OAL Conv.	4977 ③	2516③

☆ Air Tube kit 4948 may be required for installation.

③ Federal & California Emissions. Not For Sale or Use on vehicles licensed in the state of CA & NY (NY vehicles with CA Emissions). Check with your state authority for details.

④ Federal Emissions. Not For Sale or Use on vehicles licensed in the state of CA. Check with your state authority.

⑤ California Emissions. Not For Sale or Use on vehicles licensed in the state of CA & NY. Check with your state authority.

**APPLICATION LISTINGS**  
**FEDERAL CONVERTERS**



YR/YRS	CYL	LITER	DESCRIPTION	DIRECT FIT	UNIVERSAL
<b>CHEVROLET S-Series (2WD), T-Series (4WD) PICKUP (Cont.)</b>					
96-99	6	4.3L	4WD	9881 ③	2517③
96-97	6	4.3L	2WD	9710 ③	2516③
1995	6	4.3L	4WD & Extended Cab	9708 ③	2516③
1995	6	4.3L	RWD	4628 ③	2516③
88-94	6	4.3L		4088 ③	6906③
<b>CHEVROLET SILVERADO 2500 HD CLASSIC</b>					
2007	8	6.0L	2500 HD Classic Models Only, 133" WB, Federal Emissions, Right Side, OE System is completely welded. Additional sizing, bushings, cutting may be required.	9990 ④ -- --	-- -- --
2007	8	6.0L	2500 HD Classic Models Only, 143.5", 153", 157.5", 167" WB, Federal Emissions, Right Side, OE System is completely welded. Additional sizing, bushings, cutting may be required.	9222 ④ -- --	-- -- --
2007	8	6.0L	2500 HD Classic Models Only, 133", 157.5", 167" WB, Federal Emissions, Left Side, OE System is completely welded. Additional sizing, bushings, cutting may be required.	9223 ④ -- --	-- -- --
2007	8	8.1L	2500 HD Classic Models Only, 133" WB, Federal Emissions, Right Side, OE System is completely welded. Additional sizing, bushings, cutting may be required.	9990 ④ -- --	-- -- --
2007	8	8.1L	2500 HD Classic Models Only, 143.5", 153", 157.5", 167" WB, Federal Emissions, Right Side, OE System is completely welded. Additional sizing, bushings, cutting may be required.	9222 ④ -- --	-- -- --
2007	8	8.1L	2500 HD Classic Models Only, 133", 157.5", 167" WB, Federal Emissions, Left Side, OE System is completely welded. Additional sizing, bushings, cutting may be required.	9223 ④ -- --	-- -- --
<b>CHEVROLET SILVERADO 3500 CLASSIC</b>					
2007	8	6.0L	Cab-Chassis Classic Models Only, 133" W.B., Federal Emissions, Right Side, OE System is completely welded. Additional sizing, bushings, cutting may be required.	9990 ④ -- --	-- -- --
2007	8	6.0L	Cab-Chassis Classic Models Only, 157.5" & 167" W.B., Federal Emissions, Right Side, OE System is completely welded. Additional sizing, bushings, cutting may be required.	9222 ④ -- --	-- -- --
2007	8	6.0L	Cab-Chassis Classic Models Only; 133", 157.5", 167" W.B., Federal Emissions, Left Side, OE system is completely welded. Additional sizing, bushings, cutting may be required.	9223 ④ -- --	-- -- --
2007	8	8.1L	Cab-Chassis Classic Models Only, 133" W.B., Federal Emissions, Right Side, OE System is completely welded. Additional sizing, bushings, cutting may be required.	9990 ④ -- --	-- -- --
2007	8	8.1L	Cab-Chassis Classic Models Only, 157.5" & 167" W.B., Federal Emissions, Right Side, OE System is completely welded. Additional sizing, bushings, cutting may be required.	9222 ④ -- --	-- -- --
2007	8	8.1L	Cab-Chassis Classic Models Only; 133", 157.5", 167" W.B., Federal Emissions, Left Side, OE system is completely welded. Additional sizing, bushings, cutting may be required.	9223 ④ -- --	-- -- --
<b>CHEVROLET SONIC</b>					
12-14	4	1.8L	Manifold Unit, Front	1349 ③	--
<b>CHEVROLET SPECTRUM</b>					
87-88	4	1.5L	Turbo	4175 ③	6906③
85-88	4	1.5L	Pre-Cat Conv., (Exc. Turbo)	--	6904R③

③ Federal & California Emissions. Not For Sale or Use on vehicles licensed in the state of CA & NY (NY vehicles with CA Emissions). Check with your state authority for details.

④ Federal Emissions. Not For Sale or Use on vehicles licensed in the state of CA. Check with your state authority.

YR/YRS	CYL	LITER	DESCRIPTION	DIRECT FIT	UNIVERSAL
<b>CHEVROLET SPECTRUM (Cont.)</b>					
85-88	4	1.5L	Main Conv., (Exc. Turbo)	--	6906 <sup>③</sup>
<b>CHEVROLET SPRINT</b>					
89-91	3	All	Manual Trans. (Canada Model)	4669 <sup>③</sup>	6904 <sup>③</sup>
87-88	3	All	Turbo	--	6904 <sup>③</sup>
85-88	3	All	(Exc. Turbo)	4170 <sup>③</sup>	6904 <sup>③</sup>
<b>CHEVROLET SSR</b>					
03-04	8	5.3L	Complete Assembly	9155 <sup>③</sup>	--
03-04	8	5.3L	Right	--	2565R <sup>③</sup>
03-04	8	5.3L	Left	--	2565R <sup>③</sup>
05-06	8	6.0L	Right	--	2565R <sup>③</sup>
05-06	8	6.0L	Left	--	2565R <sup>③</sup>
<b>CHEVROLET SUBURBAN/TAHOE</b>					
2009	8	4.8L	Complete Assembly	9273 <sup>③④</sup>	--
2009	8	4.8L	Front Right	--	2566 <sup>③</sup>
2009	8	4.8L	Rear Conv.	--	2506R <sup>③</sup>
2009	8	4.8L	Front Left	--	2566 <sup>③</sup>
2009	8	4.8L	Complete Assembly	9912 <sup>③</sup>	--
07-08	8	4.8L	Federal Emissions	9233 <sup>④</sup>	--
00-05	8	4.8L	Federal Emissions	9083 <sup>④⑤</sup>	--
			Federal Emissions	9444 <sup>③</sup>	2506R <sup>④</sup>
83-87	8	5.0L		9002 <sup>③</sup>	2906 <sup>③</sup>
09-14	8	5.3L	Complete Assembly	9273 <sup>③④</sup>	--
09-14	8	5.3L	Front Right	--	2566 <sup>③</sup>
09-14	8	5.3L	Rear Conv.	--	2506R <sup>③</sup>
09-14	8	5.3L	Front Left	--	2566 <sup>③</sup>
09-14	8	5.3L	Complete Assembly	9912 <sup>③</sup>	--
07-08	8	5.3L	1/2 Ton Models, Federal Emissions	9233 <sup>④</sup>	--
00-05	8	5.3L	Federal Emissions	9083 <sup>④⑤</sup>	--
			Federal Emissions	9444 <sup>③</sup>	2506R <sup>④</sup>
98-00	8	5.7L	1/2 Ton Models, Dual Convs., to 9200 lbs GVW, Federal Emissions	9333 <sup>④</sup>	2539 <sup>④</sup>
96-99	8	5.7L	3/4 Ton Models, Front, to 9200 lbs GVW	9092 <sup>③</sup>	2516 <sup>③</sup>
96-99	8	5.7L	3/4 Ton Models, Rear, to 9200 lbs GVW	--	2516 <sup>③</sup>
96-97	8	5.7L	1/2 Ton Models, Dual Convs., to 9200 lbs GVW	9333 <sup>③</sup>	2539 <sup>③</sup>
94-95	8	5.7L	To 8600 lbs GVW	9648 <sup>③</sup>	2907 <sup>③</sup>
88-93	8	5.7L	To 8600 lbs GVW	9184 <sup>③</sup>	8007 <sup>③</sup>
88-93	8	5.7L	To 11,000 lbs GVW	10903 <sup>③</sup>	10907 <sup>③</sup>
1987	8	5.7L	Fuel Injection	9184 <sup>③</sup>	2907 <sup>③</sup>
83-86	8	5.7L		9002 <sup>③</sup>	2906 <sup>③</sup>
07-08	8	6.0L	SUBURBAN 1500, Federal Emissions	9233 <sup>④</sup>	--
06-08	8	6.0L	SUBURBAN 2500, Right	--	2585 <sup>③④</sup>
06-08	8	6.0L	SUBURBAN 2500, Left	--	2585 <sup>③④</sup>
02-03	8	6.0L	Right, Federal Emissions	--	2540 <sup>④</sup>
02-03	8	6.0L	Left, Federal Emissions	--	2540 <sup>④</sup>
01-02	8	6.0L	3/4 Ton Models, 2WD, Left, Calif. Emissions	9213 <sup>⑤</sup>	--
01-02	8	6.0L	3/4 Ton Models, 2WD, Right, Calif. Emissions	9220 <sup>⑤</sup>	--
2000	8	6.0L	3/4 Ton Suburban, Right	9253 <sup>③</sup>	--
96-99	8	7.4L	3/4 Ton Models, Front	9703 <sup>③</sup>	8006 <sup>③</sup>

① Discontinued, use until inventory is depleted.

② Federal & California Emissions. Not For Sale or Use on vehicles licensed in the state of CA & NY (NY vehicles with CA Emissions). Check with your state authority for details.

③ Federal Emissions. Not For Sale or Use on vehicles licensed in the state of CA. Check with your state authority.

④ California Emissions. Not For Sale or Use on vehicles licensed in the state of CA & NY. Check with your state authority.

⑤ EPA Enhanced OBDII By Design Unit

**APPLICATION LISTINGS  
FEDERAL CONVERTERS**



YR/YRS	CYL	LITER	DESCRIPTION	DIRECT FIT	UNIVERSAL
<b>CHEVROLET SUBURBAN/TAHOE (Cont.)</b>					
96-99	8	7.4L	3/4 Ton Models, Rear	--	8006 <sup>Ⓞ</sup>
91-95	8	7.4L	To 8600 lbs GVW	9184 <sup>Ⓞ</sup>	8007 <sup>Ⓞ</sup>
91-95	8	7.4L	To 11,000 lbs GVW	10903 <sup>Ⓞ</sup>	10907 <sup>Ⓞ</sup>
87-89	8	7.4L	To 8600 lbs GVW	9184 <sup>Ⓞ</sup>	8007 <sup>Ⓞ</sup>
87-89	8	7.4L	To 11,620 lbs GVW	10903 <sup>Ⓞ</sup>	10907 <sup>Ⓞ</sup>
2006	8	8.1L	SUBURBAN 2500, Right	--	2585 <sup>Ⓞ</sup> <sup>Ⓞ</sup>
2006	8	8.1L	SUBURBAN 2500, Left	--	2585 <sup>Ⓞ</sup> <sup>Ⓞ</sup>
75-82	8	All		9002 <sup>Ⓞ</sup>	9006 <sup>Ⓞ</sup>
<b>CHEVROLET TRACKER</b>					
99-02	4	1.6L	Front, California Emissions	1074 <sup>Ⓞ</sup>	--
98-02	4	1.6L		4174 <sup>Ⓞ</sup>	2514 <sup>Ⓞ</sup>
99-04	4	2.0L	Front, California Emissions	1074 <sup>Ⓞ</sup>	--
99-03	4	2.0L		4174 <sup>Ⓞ</sup>	2514 <sup>Ⓞ</sup>
99-00	4	2.0L	Rear, California Emissions	4174 <sup>Ⓞ</sup>	2514 <sup>Ⓞ</sup>
01-04	6	2.5L	Rear Conv.	4635 <sup>Ⓞ</sup>	--
01-04	6	2.5L	Front Left	1134 <sup>Ⓞ</sup>	--
01-04	6	2.5L	Front Right	1135 <sup>Ⓞ</sup>	--
<b>CHEVROLET TRAILBLAZER</b>					
08-09	6	4.2L		9546 <sup>Ⓞ</sup>	--
06-07	6	4.2L	(Exc. Ext. Models)	9171 <sup>Ⓞ</sup>	2506 <sup>Ⓞ</sup>
02-05	6	4.2L	(Exc. Ext. Models)	9154 <sup>Ⓞ</sup>	2506R <sup>Ⓞ</sup>
06-08	8	5.3L		9544 <sup>Ⓞ</sup>	--
06-07	8	5.3L		9412 <sup>Ⓞ</sup>	2566 <sup>Ⓞ</sup>
06-09	8	6.0L		9544 <sup>Ⓞ</sup>	--
<b>CHEVROLET TRAILBLAZER EXT</b>					
02-05	6	4.2L		9254 <sup>Ⓞ</sup> <sup>Ⓞ</sup>	--
				9998 <sup>Ⓞ</sup>	2506R <sup>Ⓞ</sup>
05-06	8	5.3L	Center	9871 <sup>Ⓞ</sup>	--
<b>CHEVROLET TRAVERSE</b>					
09-15	6	3.6L	Rear Main	4695 <sup>Ⓞ</sup>	--
09-11	6	3.6L	Front Conv.	4572 <sup>Ⓞ</sup>	--
09-11	6	3.6L	Rear Conv.	4573 <sup>Ⓞ</sup>	--
<b>CHEVROLET UPLANDER</b>					
05-06	6	3.5L	FWD	4429 <sup>Ⓞ</sup>	2566 <sup>Ⓞ</sup>
07-08	6	3.9L		4464 <sup>Ⓞ</sup>	2565 <sup>Ⓞ</sup>
<b>CHEVROLET VEGA</b>					
75-77	4	All	Straight Conv.	--	6905 <sup>Ⓞ</sup>
75-77	4	All	Angled Conv.	--	6905 <sup>Ⓞ</sup>
<b>CHEVROLET VENTURE</b>					
02-05	6	3.4L	FWD	4307 <sup>Ⓞ</sup>	2585 <sup>Ⓞ</sup> <sup>Ⓞ</sup>
			FWD	--	2516 <sup>Ⓞ</sup> <sup>□</sup>
2001	6	3.4L		4327 <sup>Ⓞ</sup>	2516 <sup>Ⓞ</sup>
97-00	6	3.4L		4133 <sup>Ⓞ</sup>	2505R <sup>Ⓞ</sup>
<b>CHRYSLER 300</b>					
05-10	6	2.7L	Right, RWD	4330 <sup>Ⓞ</sup>	2565 <sup>Ⓞ</sup> <sup>Ⓞ</sup>
			Right, RWD	--	2565R <sup>Ⓞ</sup> <sup>□</sup>

- Ⓞ Discontinued, use until inventory is depleted.
- Ⓞ Federal & California Emissions. Not For Sale or Use on vehicles licensed in the state of CA & NY (NY vehicles with CA Emissions). Check with your state authority for details.
- Ⓞ California Emissions. Not For Sale or Use on vehicles licensed in the state of CA & NY. Check with your state authority.
- EPA OBDII By Design Unit
- EPA Enhanced OBDII By Design Unit



YR/YRS	CYL	LITER	DESCRIPTION	DIRECT FIT	UNIVERSAL
<b>CHRYSLER 300 (Cont.)</b>					
05-10	6	2.7L	Left, RWD	4331 ③	2565③○
			Left, RWD	--	2565R③□
05-10	6	3.5L	Right, RWD	4330 ③	2565③○
			Right, RWD	--	2565R③□
05-10	6	3.5L	Left, RWD	4331 ③	2565③○
			Left, RWD	--	2565R③□
11-12	6	3.6L	Right	4672 ③	--
11-12	6	3.6L	Left	4673 ③	--
05-07	8	5.7L	Right, RWD	4430 ③	2565③□
			Right, RWD	--	2556③○
05-07	8	5.7L	Left, RWD	4431 ③	2565③□
			Left, RWD	--	2556③○
<b>CHRYSLER 300M</b>					
99-04	6	3.5L	Right	5151 ③	2505R③
99-04	6	3.5L	Semi- Direct Fit, fabrication required, Right	4252 ③	2505R③
99-04	6	3.5L	Left	4851 ③	2505R③
<b>CHRYSLER ASPEN</b>					
2007	8	4.7L		9989 ③	2575R③
<b>CHRYSLER CIRRUS</b>					
95-00	4	2.4L		4859 ③	2505③
95-00	6	2.5L		4859 ③	2505③
<b>CHRYSLER CONCORDE</b>					
02-04	6	2.7L	Right	4344 ③	2504R③
02-04	6	2.7L	Left	4851 ③	2504R③
98-01	6	2.7L	Semi- Direct Fit, fabrication required, Right	4852 ③	2504R③
98-01	6	2.7L	Left	4851 ③	2504R③
98-01	6	3.2L	Right	4452 ③	2505R③
98-01	6	3.2L	Left	4851 ③	2505R③
93-96	6	3.3L	Right Front, Federal Models	1092 ④	2538④
93-96	6	3.3L	Left Front, Federal Models	1093 ④	2538④
93-96	6	3.3L	For use with OE intermediate pipe, Main Conv., additional sizing, bushings, cutting may be required due to OE exhaust design.	4596 ②③	2513③
				--	--
93-96	6	3.3L	For use with aftermarket intermediate pipe, Main Conv., additional sizing, bushings, cutting may be required due to OE exhaust design.	4596G ②③	2513③
				--	--
93-96	6	3.3L	Right, California Emissions & 3 Bolt Inlet Flanges	1091 ⑤	--
93-96	6	3.3L	Left, California Emissions & 3 Bolt Inlet Flanges	1090 ⑤	--
93-96	6	3.3L	For use with OE intermediate pipe, Rear Main, California Emissions, additional sizing, bushings, cutting may be required due to OE exhaust design.	4596 ②⑤	2513⑤
				--	--
				--	--
93-96	6	3.3L	For use with aftermarket intermediate pipe, Rear Main, California Emissions, additional sizing, bushings, cutting may be required due to OE exhaust design.	4596G ②⑤	2513⑤
				--	--
				--	--
02-04	6	3.5L	Right	4452 ③	2504R③
02-04	6	3.5L	Left	4851 ③	2504R③
96-97	6	3.5L	Right Front	1046 ③	--
96-97	6	3.5L	Left Front	1047 ③	--

- ② When using with aftermarket piping, direct fit converter may require INLET/OUTLET pipe resizing.  
 ③ Federal & California Emissions. Not For Sale or Use on vehicles licensed in the state of CA & NY (NY vehicles with CA Emissions). Check with your state authority for details.  
 ④ Federal Emissions. Not For Sale or Use on vehicles licensed in the state of CA. Check with your state authority.  
 ⑤ California Emissions. Not For Sale or Use on vehicles licensed in the state of CA & NY. Check with your state authority.  
 □ EPA OBDII By Design Unit  
 ○ EPA Enhanced OBDII By Design Unit

# APPLICATION LISTINGS

## FEDERAL CONVERTERS



YR/YRS	CYL	LITER	DESCRIPTION	DIRECT FIT	UNIVERSAL
<b>CHRYSLER CONCORDE (Cont.)</b>					
96-97	6	3.5L	Main Conv., additional sizing, bushings, cutting may be required due to OE exhaust design.	4418 ②③	2513③
93-95	6	3.5L	Right Front	1046 ③	--
93-95	6	3.5L	Left Front	1047 ③	--
93-95	6	3.5L	Main Conv., additional sizing, bushings, cutting may be required due to OE exhaust design.	4418 ②③	2908③
<b>CHRYSLER CONQUEST</b>					
87-89	4	2.6L	Turbo, Rear	--	6904③
<b>CHRYSLER CORDOBA</b>					
80-83	6	3.7L	Underbody	--	6004③
80-83	6	3.7L	Main Plus Pre Cat Eliminator	--	6004③
81-83	8	5.2L	Underbody	--	6005③
81-83	8	5.2L	Main Plus Pre Cat Eliminator	--	6005③
1980	8	5.2L	Right, Dual Exhaust	--	6905③
1980	8	5.2L	Left, Dual Exhaust	--	6905③
1979	8	5.2L		--	6905③
1980	8	5.9L	Right, Dual Exhaust	--	6905③
1980	8	5.9L	Left, Dual Exhaust	--	6905③
1979	8	5.9L		--	6905③
75-78	8	6.6L	400 C.I.D.	--	8005③
1980	8	All	(Exc. Models w/Lean Burn)	--	6005③
1980	8	All	California Emissions	--	6005⑤
1980	8	All	Lean Burn Models	--	8005③
75-78	8	All	(Exc. 400 C.I.D. )	--	6905③
<b>CHRYSLER CROSSFIRE</b>					
04-08	6	3.2L	Right, Exc. 05-06 Supercharged	4378 ③	2575③
04-08	6	3.2L	Left, Exc. 05-06 Supercharged	4379 ③	2575③
<b>CHRYSLER DAYTONA</b>					
87-88	4	2.2L	Turbo (Canada Model)	--	6906③
1986	4	2.2L	Turbo (Canada Model)	--	6904③
84-85	4	2.2L	Turbo (Canada Model)	--	6904③
89-93	4	2.5L	(Exc. Turbo) (Canada Model)	4051 ☆③	6004③
89-92	4	2.5L	Turbo (Canada Model)	--	6906③
<b>CHRYSLER DYNASTY</b>					
88-93	4	2.5L	(Canada Model)	4051 ☆③	6004③
92-93	6	3.3L	(Canada Model)	--	6005③
88-91	6	All	(Canada Model)	--	6906③
<b>CHRYSLER E CLASS</b>					
1984	4	2.2L	Turbo	--	6905③
1984	4	2.2L	(Exc. Turbo)	--	6004③
1983	4	2.2L		--	6004③
83-84	4	2.6L		--	6904③
<b>CHRYSLER FIFTH AVENUE</b>					
92-93	6	3.3L		4283 ③	6905③
1991	6	3.3L		--	6906③
1990	6	3.3L		--	6906③
1983	6	3.7L	Underbody	--	6004③

☆ Air Tube kit 4948 may be required for installation.

② When using with aftermarket piping, direct fit converter may require INLET/OUTLET pipe resizing.

③ Federal & California Emissions. Not For Sale or Use on vehicles licensed in the state of CA & NY (NY vehicles with CA Emissions). Check with your state authority for details.

⑤ California Emissions. Not For Sale or Use on vehicles licensed in the state of CA & NY. Check with your state authority.

YR/YRS	CYL	LITER	DESCRIPTION	DIRECT FIT	UNIVERSAL
<b>CHRYSLER FIFTH AVENUE (Cont.)</b>					
92-93	6	3.8L		4283 ③	6905③
1991	6	3.8L		--	6906③
83-89	8	5.2L	Underbody	--	6004③
<b>CHRYSLER IMPERIAL</b>					
1991	6	3.3L		--	6906③
1990	6	3.3L	Conv. includes Resonator	4223 ③	6906③
92-93	6	3.8L		4283 ③	6905③
81-83	8	5.2L	Rear	--	6004③
1975	8	All	(Exc. Dual Exhaust)	--	8006③
1975	8	All	Right, Dual Exhaust	--	8006③
1975	8	All	Left, Dual Exhaust	--	8006③
<b>CHRYSLER INTREPID</b>					
93-95	6	3.3L	Right (Canada Model)	--	6804③
93-95	6	3.3L	Left (Canada Model)	--	6804③
93-95	6	3.3L	For use with OE intermediate pipe, Main Conv., additional sizing, bushings, cutting may be required due to OE exhaust design. (Canada Model)	4596 ②③	2908③
				--	--
				--	--
93-95	6	3.3L	For use with aftermarket intermediate pipe, Main Conv., additional sizing, bushings, cutting may be required due to OE exhaust design. (Canada Model)	4596G ②③	2908③
				--	--
				--	--
93-95	6	3.5L	Right (Canada Model)	--	6804③
93-95	6	3.5L	Left (Canada Model)	--	6804③
93-95	6	3.5L	Main Conv. (Canada Model)	4418 ③	2908③
<b>CHRYSLER LASER</b>					
1986	4	2.2L	Rear, Turbo	--	6905③
84-86	4	All	(Exc. Turbo)	4051 ☆③	6004③
84-85	4	All	Rear, Turbo	--	6905③
<b>CHRYSLER LEBARON</b>					
89-90	4	2.2L	Turbo, (Exc. GTS)	--	6906③
1989	4	2.2L	(Exc. Turbo)	4051 ☆③	6004③
1988	4	2.2L	4 Dr., (Exc. Turbo)	--	6004③
87-88	4	2.2L	Turbo 2 Dr.	--	6906③
87-88	4	2.2L	Turbo 4 Dr.	--	6005③
86-87	4	2.2L	(Exc. Turbo)	--	6004③
1985	4	2.2L	EFI, (Exc. Turbo)	--	6005③
84-85	4	2.2L	Turbo	--	6005③
1984	4	2.2L	TBI	--	6004③
82-83	4	2.2L		--	6004③
82-83	4	2.2L	Front	--	6004③
89-93	4	2.5L	(Exc. Turbo)	4051 ☆③	6004③
89-92	4	2.5L	Turbo, (Exc. GTS)	--	6906③
1988	4	2.5L	4 Dr., (Exc. Turbo)	4775 ☆③	6004③
1987	4	2.5L	Auto Trans., (Exc. GTS or Turbo)	4775 ☆③	6004③
1986	4	2.5L	Front	4775 ☆③	6004③
83-85	4	2.6L		--	6904③
1982	4	2.6L	Front	--	6904③
1982	4	2.6L		--	6905③

☆ Air Tube kit 4948 may be required for installation.

② When using with aftermarket piping, direct fit converter may require INLET/OUTLET pipe resizing.

③ Federal & California Emissions. Not For Sale or Use on vehicles licensed in the state of CA & NY (NY vehicles with CA Emissions). Check with your state authority for details.

# APPLICATION LISTINGS

## FEDERAL CONVERTERS



YR/YRS	CYL	LITER	DESCRIPTION	DIRECT FIT	UNIVERSAL
<b>CHRYSLER LEBARON (Cont.)</b>					
88-89	4	All	GTS Turbo	--	6906③
92-95	6	3.0L		4875 ③	6905③
90-91	6	3.0L		--	6906③
80-81	6	3.7L	Rear, 2 Dr.	--	6004③
80-81	6	3.7L	Main Plus Pre Cat, 2 Dr.	--	6004③
80-81	6	3.7L	Rear, 4 Dr. & Station Wgn.	--	6904③
80-81	6	3.7L	4 Dr. & Station Wgn., Main Plus Pre Cat Eliminator	--	6004③
1979	6	3.7L	Underbody	--	6904③
1979	6	3.7L	Main Plus Pre Cat Eliminator	--	6004③
1978	6	3.7L	Rear	--	6904③
1978	6	3.7L	Main Plus Pre Cat Eliminator	--	6004③
1981	8	5.2L	Rear, 4 Dr. or Station Wgn.	--	6004③
1981	8	5.2L	4 Dr. & Station Wgn., Main Plus Pre Cat Eliminator	--	6004③
1980	8	5.2L	2 Dr.	--	6005③
77-78	8	5.2L		--	6905③
1978	8	5.9L	Single Exhaust	--	6905③
1978	8	5.9L	Right, Dual Exhaust	--	6905③
1978	8	5.9L	Left, Dual Exhaust	--	6905③
1979	8	All	Single Exhaust	--	6905③
1979	8	All	Right, Dual Exhaust	--	6905③
1979	8	All	Left, Dual Exhaust	--	6905③
<b>CHRYSLER LHS</b>					
99-01	6	3.5L	Right, Includes Pipe Between Converter and Front Muffler	4452 ③	2505R③
99-01	6	3.5L	Semi- Direct Fit, fabrication required, Right	4252 ③	2505R③
99-01	6	3.5L	Left	4851 ③	2505R③
96-97	6	3.5L	Right Front	1046 ③	--
96-97	6	3.5L	Left Front	1047 ③	--
96-97	6	3.5L	Main Conv., additional sizing, bushings, cutting may be required due to OE exhaust design.	4418 ②③	2513③
94-95	6	3.5L	Right Front	1046 ③	--
94-95	6	3.5L	Left Front	1047 ③	--
94-95	6	3.5L	Main Conv., additional sizing, bushings, cutting may be required due to OE exhaust design.	4418 ②③	2908③
<b>CHRYSLER NEW YORKER</b>					
87-88	4	2.2L	Turbo	--	6906③
1986	4	2.2L		--	6905③
84-85	4	2.2L	Turbo	--	6905③
83-84	4	2.2L	(Exc. Turbo)	--	6004③
1987	4	2.5L		4775 ☆③	6004③
1986	4	2.5L		4775 ☆③	6004③
1985	4	2.6L		--	6904③
83-84	4	2.6L		--	6904③
88-90	6	3.0L	Conv. includes Resonator	4223 ③	6906③
92-93	6	3.3L		4283 ③	6905③
90-91	6	3.3L		--	6906③
1996	6	3.5L	Left Front	1047 ③	--
1996	6	3.5L	Right Front	1046 ③	--

☆ Air Tube kit 4948 may be required for installation.

② When using with aftermarket piping, direct fit converter may require INLET/OUTLET pipe resizing.

③ Federal & California Emissions. Not For Sale or Use on vehicles licensed in the state of CA & NY (NY vehicles with CA Emissions). Check with your state authority for details.

YR/YRS	CYL	LITER	DESCRIPTION	DIRECT FIT	UNIVERSAL
<b>CHRYSLER NEW YORKER (Cont.)</b>					
1996	6	3.5L	Main Conv., additional sizing, bushings, cutting may be required due to OE exhaust design.	4418 ②③ --	2513③ --
94-95	6	3.5L	Left Front	1047 ③	--
94-95	6	3.5L	Right Front	1046 ③	--
94-95	6	3.5L	Main Conv., additional sizing, bushings, cutting may be required due to OE exhaust design.	4418 ②③ --	2908③ --
1982	6	3.7L	Underbody	--	6004③
1982	6	3.7L	Main Plus Pre Cat	--	6004③
1982	8	5.2L		--	6005③
1982	8	5.2L	Main Plus Pre Cat	--	6005③
80-81	8	5.2L	Rear	--	6905③
80-81	8	5.2L	Main Plus Pre Cat	--	6005③
1980	8	5.9L		--	6905③
77-78	8	5.9L		--	6906③
75-78	8	6.6L	(Exc. Dual Exhaust)	--	8006③
75-78	8	7.2L	(Exc. Dual Exhaust)	--	8006③
1979	8	All		--	6905③
75-76	8	All	Right, Dual Exhaust	--	8006③
75-76	8	All	Left, Dual Exhaust	--	8006③
<b>CHRYSLER NEWPORT</b>					
80-81	6	3.7L	Rear	--	6904③
1979	6	3.7L		--	6905③
80-81	8	5.2L	(Exc. Lean Burn)	--	6905③
80-81	8	5.2L	Lean Burn Models	--	8005③
1979	8	5.2L		--	6905③
79-80	8	5.9L		--	6905③
75-78	8	7.2L	440 C.I.D., (Exc. Dual Exhaust)	--	8005③
75-78	8	All	(Exc. 440 7.2L or Dual Exhaust)	--	8005③
75-78	8	All	Right, Dual Exhaust	--	8005③
75-78	8	All	Left, Dual Exhaust	--	8005③
<b>CHRYSLER PACIFICA</b>					
04-06	6	3.5L		4298 ③ --	2571R③○ 2506R③□
05-08	6	3.8L		4427 ③ --	2571R③○ 2565R③□
2007	6	4.0L	Manifold Unit, Front Right	1279 ③	--
<b>CHRYSLER PT CRUISER</b>					
01-10	4	2.4L	Includes Turbo Includes Turbo	4292 ③ --	2571R③○ 2505R③□
<b>CHRYSLER SEBRING</b>					
95-99	4	2.0L	(Exc. Convertible)	4359 ③	2505③
09-10	4	2.4L	Eng. Code ED3	4415 ③	2571R③
07-08	4	2.4L		4415 ③	2571R③
2006	4	2.4L	Sedan & Convertible	4275 ③	2504R③
04-05	4	2.4L	Sedan & Convertible Exc. PZEV Emissions	4275 ③	2504R③
01-05	4	2.4L	Coupe, Front	1082 ③	--
01-05	4	2.4L	Coupe, Rear	4332 ③	2505③

② When using with aftermarket piping, direct fit converter may require INLET/OUTLET pipe resizing.

③ Federal & California Emissions. Not For Sale or Use on vehicles licensed in the state of CA & NY (NY vehicles with CA Emissions). Check with your state authority for details.

□ EPA OBDII By Design Unit

○ EPA Enhanced OBDII By Design Unit

**APPLICATION LISTINGS  
FEDERAL CONVERTERS**



YR/YRS	CYL	LITER	DESCRIPTION	DIRECT FIT	UNIVERSAL
<b>CHRYSLER SEBRING (Cont.)</b>					
01-03	4	2.4L	Sedan & Convertible	4275 ③	2504R③
96-98	4	2.4L	Convertible Models	4859 ③	2505③
98-00	6	2.5L	Coupe, California Emissions, Front Left	1277 ⑤	--
98-00	6	2.5L	Coupe, California Emissions, Front Right	1278 ⑤	--
96-00	6	2.5L	Convertible Models	4859 ③	2505③
95-00	6	2.5L	Rear Manifold, (Exc. Convertible), Federal Emissions	1164 ④	--
95-00	6	2.5L	Middle Conv., (Exc. Convertible), Federal Emissions	4164 ④	--
95-00	6	2.5L	Rear, (Exc. Convertible), Federal Emissions	4264 ④	2540④
01-06	6	2.7L	Manifold Unit, Front	4142 ③	--
01-06	6	2.7L	Rear Manifold Conv.	4143 ③	--
01-05	6	3.0L	Front Side	1094 ③	--
01-05	6	3.0L	Rear Side	1095 ③	--
01-05	6	3.0L	Main Rear	4393 ③	2540③
<b>CHRYSLER TC</b>					
89-91	4,6	All		--	6904③
<b>CHRYSLER TOWN &amp; COUNTRY</b>					
08-10	6	3.3L		4441 ③	2576R③○
05-07	6	3.3L	With Stow and Go Option	4213 ③	2576R③○
			Without Stow and Go Option	--	2571R③□
05-07	6	3.3L	Without Stow and Go Option	4277 ③	2571R③
01-04	6	3.3L		4277 ③	2571R③
96-00	6	3.3L	Federal Emissions	4967 ④	2540④
96-00	6	3.3L	California Emissions	4183 ⑤	2540⑤
92-93	6	3.3L	(Exc. AWD)	4049 ③	2905③
92-93	6	3.3L	AWD	4892 ③	2906③
90-91	6	3.3L	(Exc. AWD)	4466 ③	6905③
11-16	6	3.6L	Front Left	1280 ③	--
11-16	6	3.6L	Front Right	1281 ③	--
08-10	6	3.8L		4441 ③	2576R③○
05-07	6	3.8L		4213 ③	2576R③○
				--	2571R③□
01-04	6	3.8L		4269 ③	2571R③
96-00	6	3.8L	Federal Emissions	4967 ④	2540④
96-00	6	3.8L	California Emissions	4183 ⑤	2540⑤
94-95	6	3.8L	(Exc. AWD)	4049 ③	2905③
94-95	6	3.8L	AWD	4892 ③	2906③
<b>CHRYSLER VOYAGER, GRAND VOYAGER</b>					
01-03	4	2.4L		9301 ③	2565R③
2000	4	2.4L		4967 ③	2540③
2000	6	3.0L		4887 ③	2540③
01-03	6	3.3L		4277 ③	2571R③
2000	6	3.3L	Federal Emissions	4967 ④	2540④
2000	6	3.3L	California Emissions	4183 ⑤	2540⑤
<b>DAEWOO LANOS</b>					
1999	4	1.5L		--	2539③
99-02	4	1.6L	Front Straight Unit	4405 ③	--
99-02	4	1.6L	Rear Conv. for Vehicles with Front Conv. with Curved Outlet	--	2504③

- ③ Federal & California Emissions. Not For Sale or Use on vehicles licensed in the state of CA & NY (NY vehicles with CA Emissions). Check with your state authority for details.
- ④ Federal Emissions. Not For Sale or Use on vehicles licensed in the state of CA. Check with your state authority.
- ⑤ California Emissions. Not For Sale or Use on vehicles licensed in the state of CA & NY. Check with your state authority.
- EPA OBDII By Design Unit
- EPA Enhanced OBDII By Design Unit

YR/YRS	CYL	LITER	DESCRIPTION	DIRECT FIT	UNIVERSAL
<b>DAEWOO LEGANZA</b>					
99-02	4	2.2L	Leganza, Front	1052 ③	--
99-02	4	2.2L	Leganza, Rear	4352 ③	2505 ③
<b>DAEWOO NUBIRA</b>					
99-02	4	2.0L	Nubira, Front	1054 ③	--
99-02	4	2.0L	Nubira, Rear	4254 ③	2540 ③
<b>DAIHATSU CHARADE</b>					
89-92	3	1.0L	Rear	--	6904 ③
89-92	4	1.3L	Rear	--	6904 ③
<b>DAIHATSU ROCKY</b>					
90-92	4	1.6L		--	6904 ③
<b>DELOREAN DMC 12</b>					
81-82	6	2.9L		--	6904 ③
<b>DODGE 2000 GTX</b>					
89-90	4	All		4377 ③	6904 ③
<b>DODGE ARIES, 400, 600</b>					
1989	4	2.2L		--	6004 ③
1988	4	2.2L	Auto Trans., Built After 10/12/87, (Exc. Turbo)	4775 ☆③	6004 ③
87-88	4	2.2L	Manual Trans., (Exc. Turbo)	4775 ☆③	6004 ③
87-88	4	2.2L	Turbo	--	6906 ③
1986	4	2.2L	Manual Trans., (Exc. Turbo)	--	6004 ③
1986	4	2.2L	Turbo	--	6905 ③
1986	4	2.2L	Auto Trans., (Exc. Turbo)	--	6004 ③
1985	4	2.2L	(Exc. Turbo)	--	6004 ③
1985	4	2.2L	Turbo	--	6905 ③
1984	4	2.2L	Turbo	--	6905 ③
81-84	4	2.2L	Front, w/Air Tube, (Exc. Turbo)	--	6004 ③
81-82	4	2.2L	Rear, w/Air Tube	--	6004 ③
81-82	4	2.2L	Front, w/o Air Tube	--	6904 ③
1989	4	2.5L	Auto Trans.	4775 ☆③	6004 ③
87-88	4	2.5L		4775 ☆③	6004 ③
1986	4	2.5L		4775 ☆③	6004 ③
83-85	4	2.6L		--	6904 ③
81-82	4	2.6L		--	6904 ③
<b>DODGE ASPEN</b>					
1980	6	3.7L	Rear, 2 Dr.	--	6904 ③
1980	6	3.7L	2 Dr., Main Plus Pre Cat Eliminator	--	6004 ③
1980	6	3.7L	Rear, 4 Dr. or Station Wgn.	--	6904 ③
1980	6	3.7L	4 Dr. or Station Wgn., Main Plus Pre Cat Eliminator	--	6004 ③
1979	6	3.7L	Rear, 2 Dr.	--	6004 ③
1979	6	3.7L	2 Dr., Main Plus Pre Cat Eliminator	--	6004 ③
1979	6	3.7L	Rear, 4 Dr. or Station Wgn.	--	6904 ③
1979	6	3.7L	4 Dr. or Station Wgn., Main Plus Pre Cat Eliminator	--	6004 ③
1978	6	3.7L	2 Dr.	--	6905 ③
1978	6	3.7L	4 Dr. or Station Wgn.	--	6905 ③
1977	6	3.7L	2 Dr., 2-1/4" Pipe	--	6905 ③
1977	6	3.7L	2 Dr., 1-7/8" Pipe	--	6904 ③
1977	6	3.7L	4 Dr. or Station Wgn., 2-1/4" Pipe	--	6905 ③

☆ Air Tube kit 4948 may be required for installation.

③ Federal & California Emissions. Not For Sale or Use on vehicles licensed in the state of CA & NY (NY vehicles with CA Emissions). Check with your state authority for details.

# APPLICATION LISTINGS

## FEDERAL CONVERTERS



YR/YRS	CYL	LITER	DESCRIPTION	DIRECT FIT	UNIVERSAL
<b>DODGE ASPEN (Cont.)</b>					
1977	6	3.7L	4 Dr. or Station Wgn., 1-7/8" Pipe	--	6904③
1976	6	3.7L	2 Dr.	--	6904③
1976	6	3.7L	4 Dr. or Station Wgn.	--	6904③
79-80	8	5.2L	2 Dr., Rear	--	6905③
79-80	8	5.2L	2 Dr., Main Plus Pre Cat Eliminator	--	6005③
79-80	8	5.2L	4 Dr. or Station Wgn., Rear	--	6905③
79-80	8	5.2L	4 Dr. or Station Wgn., Main Plus Pre Cat	--	6005③
76-78	8	5.2L	2 Dr.	--	6905③
76-78	8	5.2L	4 Dr. or Station Wgn.	--	6905③
79-80	8	5.9L	Left	--	6905③
79-80	8	5.9L	Right	--	6905③
76-78	8	5.9L	2 Dr.	--	6905③
76-78	8	5.9L	4 Dr. or Station Wgn.	--	6905③
<b>DODGE AVENGER</b>					
95-99	4	2.0L	DOHC	4603 ③	2504③
09-10	4	2.4L	Eng. Code ED3	4415 ③	2571R③○
			Eng. Code ED3	--	2505R③□
2008	4	2.4L		4415 ③	2571R③○
				--	2505R③□
98-00	6	2.5L	California Emissions, Front Left	1277 ⑤	--
98-00	6	2.5L	California Emissions, Front Right	1278 ⑤	--
95-00	6	2.5L	Rear Manifold Conv., Federal Emissions	1164 ④	--
95-00	6	2.5L	Middle Conv., Federal Emissions	4164 ④	--
95-00	6	2.5L	Rear, Federal Emissions	4264 ④	2540④
08-10	6	2.7L	Manifold Unit, Front	4640 ③	--
08-10	6	2.7L	Rear Manifold Conv.	4641 ③	--
11-14	6	3.6L	Front Left	1280 ③	--
11-14	6	3.6L	Front Right	1281 ③	--
<b>DODGE B-VAN</b>					
1987	6	3.7L		--	2904③
80-86	6	3.7L	Underbody	--	2904③
75-79	6	3.7L	2" Outlet	--	6905③
98-03	6	3.9L	w/48-3/4" Conv.	9018 ③	2513③
00-02	6	3.9L		--	2516③
95-97	6	3.9L		9715 ③	2513③
93-94	6	3.9L	From 7/93	--	2905③
92-93	6	3.9L	To 7/93	9308 ③	2906③
88-91	6	3.9L		9361 ☆③	2906③
98-03	8	5.2L	w/48-3/4" Conv.	9018 ③	2513③
95-97	8	5.2L		9715 ③	2513③
80-86	8	5.2L	Underbody	--	2906③
80-86	8	5.2L	Main & Pre-Cat	--	2906③
02-03	8	5.9L	Ram 2500 Van, 3 Converter System	9907 ③	--
01-03	8	5.9L	Ram 3500 Van, 3 Converter System	9907 ③	--
98-03	8	5.9L	w/48-3/4" Conv.	9018 ③	2513③
2000	8	5.9L	Ram 2500 Van, 3 Converter System	9907 ③	--
95-97	8	5.9L	Under 8600 lbs GVW, w/53-1/4" Conv.	9715 ③	2513③

☆ Air Tube kit 4948 may be required for installation.

③ Federal & California Emissions. Not For Sale or Use on vehicles licensed in the state of CA & NY (NY vehicles with CA Emissions). Check with your state authority for details.

④ Federal Emissions. Not For Sale or Use on vehicles licensed in the state of CA. Check with your state authority.

⑤ California Emissions. Not For Sale or Use on vehicles licensed in the state of CA & NY. Check with your state authority.

□ EPA OBDII By Design Unit

○ EPA Enhanced OBDII By Design Unit



YR/YRS	CYL	LITER	DESCRIPTION	DIRECT FIT	UNIVERSAL
<b>DODGE B-VAN (Cont.)</b>					
80-86	8	5.9L	Underbody	--	2906③
80-86	8	5.9L	Main & Pre-Cat	--	2906③
93-94	8	All	From 7/93	--	2905③
92-93	8	All	To 7/93	9308 ③	2906③
87-91	8	All		9361 ☆③	2906③
80-81	8	All	w/o Pre-Cat	--	2905③
75-79	8	All		--	9006③
<b>DODGE CALIBER</b>					
07-09	4	1.8L		4415 ③	2571R③
07-10	4	2.0L		4415 ③	2571R③○ 2505R③□
2010	4	2.4L	Eng. Code ED3	4415 ③	2571R③
08-09	4	2.4L	(Exc. Turbo)	4415 ③	2571R③
07-08	4	2.4L	R/T Models, AWD, Front	1110 ③	--
07-08	4	2.4L	R/T Models, AWD, Rear	9218 ③	--
2007	4	2.4L	FWD	4415 ③	2571R③
<b>DODGE CARAVAN</b>					
84-87	4	2.2L		--	6904③
01-07	4	2.4L		9301 ③	2565R③
96-00	4	2.4L		4967 ③	2540③
91-95	4	2.5L		4953 ③	6904③
89-90	4	2.5L	(Exc. Turbo)	4953 ③	6904③
89-90	4	2.5L	Turbo	--	6905③
84-87	4	2.6L	Front	--	6904③
84-87	4	2.6L		--	6904③
1988	4	All		4953 ③	6904③
96-00	6	3.0L		4887 ③	2540③
92-95	6	3.0L		4049 ③	2905③
89-91	6	3.0L		4765 ③	6905③
87-88	6	3.0L		--	6905③
08-10	6	3.3L	Grand Caravan	4441 ③	2576R③○
06-07	6	3.3L	Grand Caravan	4213 ③	2576R③○
			Grand Caravan	--	2571R③□
05-07	6	3.3L	Caravan	4277 ③	2571R③
2005	6	3.3L	Grand Caravan with Stow and Go Option	4213 ③	2576R③○
			Grand Caravan with Stow and Go Option	--	2571R③□
2005	6	3.3L	Grand Caravan without Stow and Go Option	4277 ③	2571R③
01-04	6	3.3L		4277 ③	2571R③
96-00	6	3.3L	Federal Emissions	4967 ④	2540④
96-00	6	3.3L	California Emissions	4183 ⑤	2540⑤
94-95	6	3.3L	(Exc. AWD or Flexible Fuel)	4049 ③	2905③
1994	6	3.3L	AWD	4892 ③	2906③
92-93	6	3.3L	(Exc. AWD)	4652 ③	6905③
91-93	6	3.3L	AWD	4892 ③	2906③
90-91	6	3.3L	(Exc. AWD)	4466 ③	6905③
11-16	6	3.6L	Grand Caravan, Front Left	1280 ③	--
11-16	6	3.6L	Grand Caravan, Front Right	1281 ③	--

☆ Air Tube kit 4948 may be required for installation.

③ Federal & California Emissions. Not For Sale or Use on vehicles licensed in the state of CA & NY (NY vehicles with CA Emissions). Check with your state authority for details.

④ Federal Emissions. Not For Sale or Use on vehicles licensed in the state of CA. Check with your state authority.

⑤ California Emissions. Not For Sale or Use on vehicles licensed in the state of CA & NY. Check with your state authority.

**APPLICATION LISTINGS**  
**FEDERAL CONVERTERS**



YR/YRS	CYL	LITER	DESCRIPTION	DIRECT FIT	UNIVERSAL
<b>DODGE CARAVAN (Cont.)</b>					
08-10	6	3.8L	Grand Caravan	4441 ③	2576R③○
05-07	6	3.8L		4213 ③	2576R③○
				--	2571R③□
01-04	6	3.8L		4269 ③	2571R③
96-00	6	3.8L	Federal Emissions	4967 ④	2540④
96-00	6	3.8L	California Emissions	4183 ⑤	2540⑤
94-95	6	3.8L	AWD	4892 ③	2906③
94-95	6	3.8L	(Exc. AWD or Flexible Fuel)	4049 ③	2905③
<b>DODGE CHALLENGER</b>					
78-79	4	1.6L		--	6904③
80-83	4	2.6L	Donut Gasket at Inlet	--	6906③
79-80	4	2.6L	(Exc. Donut Gasket at Inlet)	--	6804③
09-10	6	3.5L	Right	4330 ③	--
09-10	6	3.5L	Left	4331 ③	--
11-12	6	3.6L	Right	4672 ③	--
11-12	6	3.6L	Left	4673 ③	--
<b>DODGE CHARGER</b>					
1984	4	1.6L	Front	--	6004③
85-87	4	2.2L	(Exc. Turbo)	--	6004③
85-87	4	2.2L	Turbo	--	6905③
83-84	4	2.2L	Front	--	6004③
06-10	6	2.7L	Right	4330 ③	2565③○
			Right	--	2565R③□
06-10	6	2.7L	Left	4331 ③	2565③○
			Left	--	2565R③□
2007	6	2.7L	With Front Mini Converter, Left	5034 ③	--
2007	6	2.7L	With Front Mini Converter, Right	5035 ③	--
06-10	6	3.5L	Right	4330 ③	2565③○
			Right	--	2565R③□
06-10	6	3.5L	Left	4331 ③	2565③○
			Left	--	2565R③□
11-12	6	3.6L	Right	4672 ③	--
11-12	6	3.6L	Left	4673 ③	--
75-76	8	5.2L		--	6905③
06-07	8	5.7L	Right, RWD	4430 ③	2565③□
			Right, RWD	--	2566③○
06-07	8	5.7L	Left, RWD	4431 ③	2565③□
			Left, RWD	--	2566③○
75-76	8	5.9L		--	6905③
2007	8	6.1L	Left	9375 ③	--
75-78	8	6.6L	400 C.I.D.	--	8005③
77-78	8	All	(Exc. 400 C.I.D.)	--	6905③
<b>DODGE COLT</b>					
81-84	4	1.4L		--	6804③
89-91	4	1.5L		4377 ③	6904③
87-88	4	1.5L		4203 ③	6904R③
85-86	4	1.5L	Rear	--	6804③

- ③ Federal & California Emissions. Not For Sale or Use on vehicles licensed in the state of CA & NY (NY vehicles with CA Emissions). Check with your state authority for details.
- ④ Federal Emissions. Not For Sale or Use on vehicles licensed in the state of CA. Check with your state authority.
- ⑤ California Emissions. Not For Sale or Use on vehicles licensed in the state of CA & NY. Check with your state authority.
- EPA OBDII By Design Unit
- EPA Enhanced OBDII By Design Unit

YR/YRS	CYL	LITER	DESCRIPTION	DIRECT FIT	UNIVERSAL
<b>DODGE COLT (Cont.)</b>					
89-90	4	1.6L		4377 ③	6904③
87-88	4	1.6L		4203 ③	6904R③
81-86	4	1.6L		--	6804③
89-90	4	1.8L		--	6904③
89-91	4	2.0L	Vista	4377 ③	6904③
87-88	4	2.0L	Vista, Built After 12/86	4377 ③	6904③
1987	4	2.0L	Vista, Built Before 12/86	--	6804③
84-86	4	2.0L	Vista	--	6804③
92-94	4	All	Includes Vista	4377 ③	6904③
<b>DODGE CONQUEST</b>					
84-86	4	2.6L	Turbo, Rear	--	6904③
<b>DODGE CORONET</b>					
75-76	6	3.7L		--	6904③
1975	8	7.2L	Right	--	8005③
1975	8	7.2L	Left	--	8005③
75-76	8	All	(Exc. 1975 w/440 C.I.D.)	--	6905③
<b>DODGE D-(2WD) &amp; W-(4WD) PICKUP 1/2 &amp; 3/4 TON</b>					
84-87	6	3.7L	Rear, 2WD Under 8500 lbs GVW, Federal Emissions	--	2905④
79-83	6	3.7L	Underbody	--	2905③
75-78	6	3.7L		--	6904③
92-93	6	3.9L	From 2/92 To 7/93	9308 ③	2906③
88-92	6	3.9L	To 2/92	9020 ☆③	2905③
92-93	8	5.2L	Under 8800 lbs GVW; From 2/92 To 7/93	9308 ③	9006③
86-90	8	5.2L	4WD	9531 ③	2906③
82-87	8	5.2L	2WD, Rear	--	9005③
1979	8	5.2L		--	9005③
92-93	8	5.9L	Under 8800 lbs GVW; From 2/92 To 7/93	9308 ③	9006③
88-92	8	5.9L	Under 8800 lbs GVW; To 2/92	9020 ☆③	9005③
88-89	8	5.9L	Over 8800 lbs GVW, Right	--	10005③
88-89	8	5.9L	Over 8800 lbs GVW, Left	--	10005③
82-87	8	5.9L	4WD	--	2906③
82-87	8	5.9L	2WD, Rear	--	9005③
1979	8	5.9L		--	9005③
80-81	8	All		--	9005③
75-78	8	All		--	9006③
<b>DODGE D-(2WD) &amp; W-(4WD) PICKUP 1 TON</b>					
90-93	8	5.9L	To 8600 lbs GVW, Right	--	9004③
90-93	8	5.9L	Over 8600 lbs GVW, Right	--	10005③
90-93	8	5.9L	To 8600 lbs GVW, Left	--	9004③
90-93	8	5.9L	Over 8600 lbs GVW, Left	--	10005③
88-91	8	5.9L	Single exhaust	9020 ☆③	9005③
82-87	8	All	w/Conv.	--	9005③
<b>DODGE DAKOTA</b>					
87-88	4	2.2L		--	6904③
1999	4	2.5L		--	2540③
97-98	4	2.5L	2WD	9147 ③	2504③
97-98	4	2.5L	4WD	--	2540③

☆ Air Tube kit 4948 may be required for installation.

③ Federal & California Emissions. Not For Sale or Use on vehicles licensed in the state of CA & NY (NY vehicles with CA Emissions). Check with your state authority for details.

④ Federal Emissions. Not For Sale or Use on vehicles licensed in the state of CA. Check with your state authority.

**APPLICATION LISTINGS  
FEDERAL CONVERTERS**



YR/YRS	CYL	LITER	DESCRIPTION	DIRECT FIT	UNIVERSAL
<b>DODGE DAKOTA (Cont.)</b>					
1996	4	2.5L		--	2539 <sup>③</sup>
93-95	4	2.5L		--	2904 <sup>③</sup>
89-92	4	2.5L	(Exc. 131" W.B.)	--	6904 <sup>③</sup>
89-92	4	2.5L	131" W.B.	--	6904 <sup>③</sup>
06-08	6	3.7L		9163 <sup>③</sup>	--
00-03	6	3.9L	4WD, Federal Emissions	9054 <sup>④</sup>	2516 <sup>④</sup>
00-03	6	3.9L	2WD, Federal Emissions	9197 <sup>④</sup>	2506R <sup>④</sup>
00-03	6	3.9L	Front Right, 2WD, California Emissions	--	2565 <sup>⑤</sup>
00-03	6	3.9L	Rear, 2WD, California Emissions	--	2506R <sup>⑤</sup>
00-03	6	3.9L	Completed Assembly, 2WD w/ Auto. Trans., California Emissions	9196 <sup>⑤</sup>	--
00-03	6	3.9L	Completed Assembly, 4WD, California Emissions	9226 <sup>⑤</sup>	--
00-03	6	3.9L	Rear, 4WD, California Emissions	--	2506 <sup>⑤</sup>
00-03	6	3.9L	Front Left, 2WD, California Emissions	--	2565 <sup>⑤</sup>
97-99	6	3.9L	4WD, 124" & 131" W.B.	9015 <sup>③</sup>	2516 <sup>③</sup>
97-99	6	3.9L	2WD, 59" Conv.	9185 <sup>③</sup>	2516 <sup>③</sup>
1996	6	3.9L	2WD, 131" W.B.	9205 <sup>③</sup>	2516 <sup>③</sup>
94-95	6	3.9L	2WD, 131" W.B.	4552 <sup>③</sup>	6006 <sup>③</sup>
92-93	6	3.9L	2WD	9618 <sup>③</sup>	2906 <sup>③</sup>
92-93	6	3.9L	4WD	--	2906 <sup>③</sup>
90-91	6	3.9L	2WD	9705 <sup>☆③</sup>	2906 <sup>③</sup>
87-89	6	3.9L	2WD, Rear	4515 <sup>☆③</sup>	6004 <sup>③</sup>
87-89	6	3.9L	4WD, Rear	4733 <sup>☆③</sup>	6004 <sup>③</sup>
2008	8	4.7L	California Emissions	9461 <sup>⑤</sup>	--
2005	8	4.7L		9163 <sup>③</sup>	--
01-03	8	4.7L	4WD, 131.5" W.B., Federal Emissions	9176 <sup>④</sup>	2506R <sup>④</sup>
01-03	8	4.7L	DF Conv., Complete Assembly, 4WD, 131.5" W.B., California Emissions	9175 <sup>⑤</sup>	--
01-03	8	4.7L	Front Right Universal, 4WD, 131.5" W.B., California Emissions	--	2565 <sup>⑤</sup>
01-03	8	4.7L	Rear Universal, 4WD, 131.5" W.B., California Emissions	--	2506R <sup>⑤</sup>
01-03	8	4.7L	Front Left Universal, 4WD, 131.5" W.B., California Emissions	--	2565 <sup>⑤</sup>
00-03	8	4.7L	RWD, Federal Emissions	9899 <sup>④</sup>	2506R <sup>④</sup>
00-03	8	4.7L	2WD, Front, California Emissions	--	2565 <sup>⑤</sup>
00-03	8	4.7L	2WD, Rear Conv., California Emissions	--	2506R <sup>⑤</sup>
00-02	8	4.7L	RWD, California Emissions	9997 <sup>⑤</sup>	--
97-99	8	5.2L	4WD, 124" & 131" W.B.	9015 <sup>③</sup>	2516 <sup>③</sup>
97-99	8	5.2L	2WD, 124" & 131" W.B.	9055 <sup>③</sup>	2516 <sup>③</sup>
97-99	8	5.2L	2WD & 4WD 112" W.B.	--	2516 <sup>③</sup>
1996	8	5.2L	(Exc. 2WD, 131" W.B.)	--	2516 <sup>③</sup>
1996	8	5.2L	2WD, 131" W.B.	9205 <sup>③</sup>	2516 <sup>③</sup>
94-95	8	5.2L	2WD, 131" W.B.	4552 <sup>③</sup>	6006 <sup>③</sup>
94-95	8	5.2L	(Exc. 2WD, 131" W.B.)	--	2905 <sup>③</sup>
92-93	8	5.2L	2WD	9618 <sup>③</sup>	2906 <sup>③</sup>
92-93	8	5.2L	4WD	--	2907 <sup>③</sup>
1991	8	5.2L		--	2905 <sup>③</sup>
98-99	8	5.9L	2WD	9055 <sup>③</sup>	2516 <sup>③</sup>

☆ Air Tube kit 4948 may be required for installation.  
 ③ Federal & California Emissions. Not For Sale or Use on vehicles licensed in the state of CA & NY (NY vehicles with CA Emissions). Check with your state authority for details.  
 ④ Federal Emissions. Not For Sale or Use on vehicles licensed in the state of CA. Check with your state authority.  
 ⑤ California Emissions. Not For Sale or Use on vehicles licensed in the state of CA & NY. Check with your state authority.

YR/YRS	CYL	LITER	DESCRIPTION	DIRECT FIT	UNIVERSAL
<b>DODGE DART, DEMON</b>					
75-76	6	3.7L		--	6904③
75-76	8	5.2L	2 Dr. Coupe	--	6905③
75-76	8	5.9L		--	6905③
75-76	8	All	(Exc. 2 Dr. Coupe w/318 C.I.D.)	--	6905③
<b>DODGE DAYTONA</b>					
1993	4	2.2L	Turbo	--	6905③
89-92	4	2.2L	Turbo	--	6906③
86-88	4	2.2L	Turbo	--	6906③
84-85	4	2.2L	Turbo	--	6905③
1984	4	2.2L	(Exc. Turbo)	4051 ☆③	6004③
89-93	4	2.5L	(Exc. Turbo)	4051 ☆③	6004③
89-92	4	2.5L	Turbo	--	6906③
87-88	4	2.5L	(Exc. Turbo)	4051 ☆③	6004③
85-86	4	All	(Exc. Turbo)	4051 ☆③	6004③
92-93	6	3.0L		4875 ③	6905③
90-91	6	3.0L		--	6905③
<b>DODGE DIPLOMAT</b>					
81-83	6	3.7L	Underbody	--	6004③
81-83	6	3.7L	Main & Pre-Cat	--	6004③
1980	6	3.7L	Rear, 2 Dr.	--	6004③
1980	6	3.7L	2 Dr., Main & Pre-Cat	--	6004③
1980	6	3.7L	Rear, 4 Dr. or Station Wgn.	--	6004③
1980	6	3.7L	4 Dr. or Station Wgn., Main & Pre-Cat	--	6004③
1979	6	3.7L	Rear, 2 Dr.	--	6004③
1979	6	3.7L	2 Dr., Main & Pre-Cat	--	6004③
1979	6	3.7L	Rear, 4 Dr. or Station Wgn.	--	6004③
1979	6	3.7L	4 Dr. or Station Wgn., Main & Pre-Cat	--	6004③
1978	6	3.7L	2 Dr.	--	6905③
1978	6	3.7L	4 Dr. or Station Wgn.	--	6905③
81-89	8	5.2L	Underbody	--	6005③
81-89	8	5.2L	Main & Pre-Cat	--	6005③
1980	8	5.2L	2 Dr.	--	6905③
1980	8	5.2L	4 Dr., Station Wgn.	--	6905③
1980	8	5.2L	California Emissions	--	6905⑤
77-78	8	5.2L	2 Dr.	--	6905③
77-78	8	5.2L	4 Dr. or Station Wgn.	--	6905③
1978	8	5.9L	2 Dr.	--	6905③
1978	8	5.9L	4 Dr. or Station Wgn.	--	6905③
1979	8	All	2 Dr.	--	6905③
1979	8	All	4 Dr. or Station Wgn.	--	6905③
<b>DODGE DURANGO</b>					
05-07	6	3.7L		9989 ③	2575R③
2004	6	3.7L		4577 ③	2516③
1999	6	3.9L	2WD	9185 ③	2516③
98-99	6	3.9L	4WD	--	2516③
05-07	8	4.7L		9989 ③	2575R③○
2004	8	4.7L		4577 ③	2516③

☆ Air Tube kit 4948 may be required for installation.

③ Federal & California Emissions. Not For Sale or Use on vehicles licensed in the state of CA & NY (NY vehicles with CA Emissions). Check with your state authority for details.

⑤ California Emissions. Not For Sale or Use on vehicles licensed in the state of CA & NY. Check with your state authority.

○ EPA Enhanced OBDII By Design Unit

# APPLICATION LISTINGS

## FEDERAL CONVERTERS



YR/YRS	CYL	LITER	DESCRIPTION	DIRECT FIT	UNIVERSAL
<b>DODGE DURANGO (Cont.)</b>					
00-03	8	4.7L	2WD, Federal Emissions	9211 ④	2506R③
00-03	8	4.7L	4WD, Federal Emissions	9111 ④	2506R④
98-99	8	5.2L	4WD	9146 ③	2516③
04-05	8	5.7L	4WD, Right Side	9274 ③	--
04-05	8	5.7L	4WD, Left Side	9275 ③	--
01-03	8	5.9L	4WD, California Emissions	9898 ⑤	--
01-03	8	5.9L	4WD, Federal Emissions	9126 ④	2506R④
2000	8	5.9L	4WD	9126 ③	2506R③
98-99	8	5.9L	4WD	9146 ③	2516③
<b>DODGE DYNASTY</b>					
88-93	4	2.5L		4051 ☆③	6004③
92-93	6	3.0L		4875 ③	6905③
88-91	6	3.0L	Conv. includes Resonator	4223 ③	6906③
92-93	6	3.3L		4283 ③	6905③
90-91	6	3.3L		--	6906③
<b>DODGE INTREPID</b>					
02-04	6	2.7L	Right	4344 ③	2504R③
02-04	6	2.7L	Left	4851 ③	2504R③
98-01	6	2.7L	Semi- Direct Fit, fabrication required, Right	4852 ③	2504R③
98-01	6	2.7L	Left	4851 ③	2504R③
98-01	6	3.2L	Right	4452 ③	2505R③
98-01	6	3.2L	Left	4851 ③	2505R③
93-97	6	3.3L	Right Front, w/2 Bolt Inlet Flange, Federal Models	1092 ④	2538④
93-97	6	3.3L	Left Front, w/2 Bolt Inlet Flange, Federal Models	1093 ④	2538④
93-97	6	3.3L	For use with OE intermediate pipe, Main Conv., additional sizing, bushings, cutting may be required due to OE exhaust design.	4596 ②③	2513③
93-97	6	3.3L	For use with aftermarket intermediate pipe, Main Conv., additional sizing, bushings, cutting may be required due to OE exhaust design.	4596G ②③	2513③
93-96	6	3.3L	Right, California Emissions & 3 Bolt Inlet Flanges	1091 ⑤	--
93-96	6	3.3L	Left, California Emissions & 3 Bolt Inlet Flanges	1090 ⑤	--
93-96	6	3.3L	For use with OE intermediate pipe, Rear Main, California Emissions, additional sizing, bushings, cutting may be required due to OE exhaust design.	4596 ②⑤	2513⑤
93-96	6	3.3L	For use with aftermarket intermediate pipe, Rear Main, California Emissions, additional sizing, bushings, cutting may be required due to OE exhaust design.	4596G ②⑤	2513⑤
02-04	6	3.5L	Right	4452 ③	2504R③
02-04	6	3.5L	Left	4851 ③	2504R③
2000	6	3.5L	Semi- Direct Fit, fabrication required, Right	4252 ③	2505R③
2000	6	3.5L	R/T Models, Left	4851 ③	2505R③
96-97	6	3.5L	Right Front	1046 ③	--
96-97	6	3.5L	Left Front	1047 ③	--
96-97	6	3.5L	Main Conv., additional sizing, bushings, cutting may be required due to OE exhaust design.	4418 ②③	2513③
93-95	6	3.5L	Right Front	1046 ③	--
93-95	6	3.5L	Left Front	1047 ③	--

☆ Air Tube kit 4948 may be required for installation.

② When using with aftermarket piping, direct fit converter may require INLET/OUTLET pipe resizing.

③ Federal & California Emissions. Not For Sale or Use on vehicles licensed in the state of CA & NY (NY vehicles with CA Emissions). Check with your state authority for details.

④ Federal Emissions. Not For Sale or Use on vehicles licensed in the state of CA. Check with your state authority.

⑤ California Emissions. Not For Sale or Use on vehicles licensed in the state of CA & NY. Check with your state authority.

YR/YRS	CYL	LITER	DESCRIPTION	DIRECT FIT	UNIVERSAL
<b>DODGE INTREPID (Cont.)</b>					
93-95	6	3.5L	Main Conv., additional sizing, bushings, cutting may be required due to OE exhaust design.	4418 ②③ --	2908③ --
<b>DODGE JOURNEY</b>					
11-14	6	3.6L	Front Left	1280 ③	--
11-14	6	3.6L	Front Right	1281 ③	--
<b>DODGE LANCER</b>					
88-89	4	2.2L	(Exc. Turbo)	4051 ☆③	6004③
88-89	4	2.2L	Turbo	--	6905③
1987	4	2.2L	Turbo	--	6005③
86-87	4	2.2L	(Exc. Turbo)	--	6904③
1985	4	2.2L	(Fuel Injection, Exc. Turbo)	--	6005③
1985	4	2.2L	Turbo	--	6905③
1989	4	2.5L	(Exc. Turbo)	4051 ☆③	6004③
1989	4	2.5L	Turbo	--	6905③
1988	4	2.5L	Auto Trans., (Exc. Turbo)	4051 ☆③	6004③
1988	4	2.5L	Manual Trans., (Exc. Turbo Built Before 10/12/87)	4775 ☆③	6004③
1988	4	2.5L	Manual Trans., (Exc. Turbo Built After 10/12/87)	4051 ☆③	6004③
1987	4	2.5L		4775 ☆③	6004③
1986	4	2.5L		4775 ☆③	6004③
<b>DODGE MAGNUM</b>					
05-08	6	2.7L	Right, RWD	4330 ③	2565③○
			Right, RWD	--	2565R③□
05-08	6	2.7L	Left, RWD	4331 ③	2565③○
			Left, RWD	--	2565R③□
2007	6	2.7L	With Front Mini Converter, Left	5034 ③	--
2007	6	2.7L	With Front Mini Converter, Right	5035 ③	--
05-08	6	3.5L	Right, RWD	4330 ③	2565③○
			Right, RWD	--	2565R③□
05-08	6	3.5L	Left, RWD	4331 ③	2565③○
			Left, RWD	--	2565R③□
05-07	8	5.7L	Right, RWD	4430 ③	2565③□
			Right, RWD	--	2556③○
05-07	8	5.7L	Left, RWD	4431 ③	2565③□
			Left, RWD	--	2556③○
<b>DODGE MAGNUM XE</b>					
1979	8	All		--	6905③
1978	8	All		--	6905③
<b>DODGE MIRADA</b>					
81-83	6	3.7L		--	6004③
1980	6	3.7L	Underbody	--	6904③
1980	6	3.7L	Main & Pre-Cat	--	6004③
81-83	8	5.2L	Underbody	--	6905③
81-83	8	5.2L	Main & Pre-Cat	--	6005③
<b>DODGE MONACO</b>					
90-92	6	3.0L		4029 ③	6905③
77-78	6	3.7L	Monaco	--	6905③
77-78	8	5.2L	Monaco	--	6905③

☆ Air Tube kit 4948 may be required for installation.

② When using with aftermarket piping, direct fit converter may require INLET/OUTLET pipe resizing.

③ Federal & California Emissions. Not For Sale or Use on vehicles licensed in the state of CA & NY (NY vehicles with CA Emissions). Check with your state authority for details.

□ EPA OBDII By Design Unit

104 ○ EPA Enhanced OBDII By Design Unit

**APPLICATION LISTINGS**  
**FEDERAL CONVERTERS**



YR/YRS	CYL	LITER	DESCRIPTION	DIRECT FIT	UNIVERSAL
<b>DODGE MONACO (Cont.)</b>					
1977	8	5.2L	Royal Monaco	--	6905 <sup>③</sup>
75-76	8	5.2L	Monaco	--	6905 <sup>③</sup>
75-76	8	5.2L	Royal Monaco	--	6905 <sup>③</sup>
77-78	8	5.9L	Monaco	--	6905 <sup>③</sup>
1977	8	5.9L	Royal Monaco	--	6905 <sup>③</sup>
75-76	8	5.9L	Monaco	--	6905 <sup>③</sup>
75-76	8	5.9L	Royal Monaco	--	6905 <sup>③</sup>
77-78	8	6.6L	Monaco, Right, Dual Exhaust	--	8005 <sup>③</sup>
77-78	8	6.6L	Monaco, Left, Dual Exhaust	--	8005 <sup>③</sup>
1977	8	6.6L	Monaco, (Exc. Dual Exhaust)	--	8005 <sup>③</sup>
75-76	8	6.6L	Royal Monaco, Right, Dual Exhaust	--	8005 <sup>③</sup>
75-76	8	6.6L	Royal Monaco, (Exc. Dual Exhaust)	--	6905 <sup>③</sup>
75-76	8	6.6L	Royal Monaco, Left, Dual Exhaust	--	8005 <sup>③</sup>
75-77	8	7.2L	Royal Monaco, Right, Dual Exhaust	--	8005 <sup>③</sup>
75-77	8	7.2L	Royal Monaco, (Exc. Dual Exhaust)	--	8006 <sup>③</sup>
75-77	8	7.2L	Royal Monaco, Left, Dual Exhaust	--	8005 <sup>③</sup>
75-76	8	7.2L	Monaco, Right, Dual Exhaust	--	8005 <sup>③</sup>
75-76	8	7.2L	Monaco, (Exc. Dual Exhaust)	--	8006 <sup>③</sup>
75-76	8	7.2L	Monaco, Left, Dual Exhaust	--	8005 <sup>③</sup>
<b>DODGE NEON</b>					
2005	4	2.0L		5152 <sup>③</sup>	--
01-04	4	2.0L	Engine VIN F	5152 <sup>③</sup>	--
00-02	4	2.0L	ULEV, VIN C, Rear	5148 <sup>③</sup>	--
00-01	4	2.0L	w/2" OD Outlet, Federal Emissions TLEV, Exc. ULEV	4094G <sup>④</sup>	2505R <sup>④</sup>
98-99	4	2.0L	OBDII Equipped, Federal Emissions, Exc. LEV	4651 <sup>④</sup>	2505 <sup>④</sup>
96-97	4	2.0L	OBDII Equipped, Federal Emissions	4651 <sup>④</sup>	2505 <sup>④</sup>
1995	4	2.0L	Non-OBD II equipped, Federal Emissions	4651 <sup>④</sup>	6905 <sup>④</sup>
00-04	4	All	w/2-1/4" OD Outlet, Exc. ULEV	4094 <sup>③</sup>	2505R <sup>③</sup>
<b>DODGE NITRO</b>					
2008	6	3.7L	Complete Assembly	9239 <sup>③</sup>	--
2008	6	3.7L	Right Side	--	2573R <sup>③</sup>
2008	6	3.7L	Left Side	--	2571R <sup>③</sup>
<b>DODGE OMNI, 024</b>					
83-86	4	1.6L	Front	--	6004 <sup>③</sup>
83-84	4	1.6L		--	6904 <sup>③</sup>
82-83	4	1.7L	Front	--	6004 <sup>③</sup>
82-83	4	1.7L		--	6904 <sup>③</sup>
1981	4	1.7L	Front	--	6004 <sup>③</sup>
80-81	4	1.7L		--	6004 <sup>③</sup>
1980	4	1.7L	Front Mini-Ox Conv.	--	6904R <sup>③</sup>
78-80	4	1.7L		--	6004 <sup>③</sup>
88-90	4	2.2L	Semi-Direct Fit, fabrication required - Outlet Pipe	--	6004 <sup>③</sup>
81-87	4	2.2L	(Exc. Turbo), Front	--	6004 <sup>③</sup>
85-86	4	2.2L	Turbo	--	6905 <sup>③</sup>
81-82	4	2.2L		--	6004 <sup>③</sup>

③ Federal & California Emissions. Not For Sale or Use on vehicles licensed in the state of CA & NY (NY vehicles with CA Emissions). Check with your state authority for details.

④ Federal Emissions. Not For Sale or Use on vehicles licensed in the state of CA. Check with your state authority.



YR/YRS	CYL	LITER	DESCRIPTION	DIRECT FIT	UNIVERSAL
<b>DODGE RAIDER</b>					
87-89	4	2.6L		4203 ③	6904③
1989	6	3.0L	16-3/8" Conv.	4377 ③	6904③
<b>DODGE RAM (2WD &amp; 4WD) PICKUP 1/2 &amp; 3/4 TON</b>					
04-05	6	3.7L	Right, 1500	9206 ③	2505R③
04-05	6	3.7L	Left, 1500	9207 ③	2505R③
02-03	6	3.7L	2WD, 4 Dr., w/Flanges, Will replace 1st or 2nd Design OEM System	9088 ③	2513③
00-01	6	3.9L		--	2513③
96-99	6	3.9L		9666 ③	2513③
94-95	6	3.9L		9647 ③	2913③
09-10	8	4.7L	Ram 1500	9450 ③	--
2008	8	4.7L	Ram 1500	9458 ③	--
04-05	8	4.7L	Right, 1500	9206 ③	2505R③
04-05	8	4.7L	Left, 1500	9207 ③	2505R③
02-03	8	4.7L	2WD, 4 Dr., w/Flanges, Will replace 1st or 2nd Design OEM System, Exc. ULEV	9088 ③	2513③
02-03	8	4.7L	R1500, 4WD, Federal Emissions	9245 ④	2513④
00-01	8	5.2L	1500	9198 ③	2513③
96-99	8	5.2L		9666 ③	2513③
94-95	8	5.2L		9647 ③	2913③
09-10	8	5.7L	Ram 1500	9462 ③	--
2009	8	5.7L	Ram 2500	9454 ③	--
2008	8	5.7L	Ram 1500, Exc. Mega Cab	9455 ③	--
06-07	8	5.7L	Ram 1500, Exc. Mega Cab	9459 ③	--
04-05	8	5.7L	Right, 1500	9168 ③	2506R③
04-05	8	5.7L	Left, 1500	9169 ③	2506R③
2003	8	5.7L	1500, 2WD, 160" W.B.	9199 ③	2513③
2003	8	5.7L	R2500	9918 ③	2576R③
2003	8	5.9L	R1500, 4WD	9915 ③	2566R③
02-03	8	5.9L	2WD, 4 Dr., w/Flanges, Will replace 1st or 2nd Design OEM System, Exc. ULEV	9088 ③	2513③
2002	8	5.9L	R1500, 4WD, Federal Emissions	9915 ④	2566R④
00-01	8	5.9L		9198 ③	2513③
96-99	8	5.9L		9666 ③	2513③
94-95	8	5.9L		9647 ③	2913③
94-02	10	8.0L	R2500 3/4 Ton Only, Dual Exhaust, 2 1/4" Pipe, With Air Tube, To 12000 lbs GVW, Left	10936 ☆③	10005③
94-02	10	8.0L	R2500 3/4 Ton Only, Dual Exhaust, 2 1/4" Pipe, With Air Tube, To 12000 lbs GVW, Right	10936 ☆③	10005③
<b>DODGE RAM (2WD &amp; 4WD) PICKUP 1 TON</b>					
2009	8	5.7L	Ram 3500	9454 ③	--
2003	8	5.7L	R3500	9918 ③	2576R③
00-01	8	5.9L		9198 ③	2513③
96-99	8	5.9L		9666 ③	2513③
1996	8	5.9L	w/H.D. Exhaust, Right	10935 ③	10905③
1996	8	5.9L	w/H.D. Exhaust, Left	--	10905③
95-96	8	5.9L	Dual Exhaust, 2-1/4" Pipe, w/o Air Tube, To 12000 lbs GVW, Right	10935 ③	--
94-95	8	5.9L	Under 8800 lbs GVW, Right	--	9005③

☆ Air Tube kit 4948 may be required for installation.

③ Federal & California Emissions. Not For Sale or Use on vehicles licensed in the state of CA & NY (NY vehicles with CA Emissions). Check with your state authority for details.

④ Federal Emissions. Not For Sale or Use on vehicles licensed in the state of CA. Check with your state authority.

**APPLICATION LISTINGS  
FEDERAL CONVERTERS**



YR/YRS	CYL	LITER	DESCRIPTION	DIRECT FIT	UNIVERSAL
<b>DODGE RAM (2WD &amp; 4WD) PICKUP 1 TON (Cont.)</b>					
94-95	8	5.9L	Under 8800 lbs GVW, Left	--	9005③
94-95	8	5.9L	2-1/4" Conv. w/o Air Tube, over 8800 lbs GVW, Right	10935 ③	10005③
94-95	8	5.9L	2-1/4" Conv. w/o Air Tube, over 8800 lbs GVW, Left	--	10005③
94-02	10	8.0L	Dual Exhaust, 2 1/4" Pipe, With Air Tube, To 12000lbs GVW, Left	10936 ☆③	10005③
94-02	10	8.0L	Dual Exhaust, 2 1/4" Pipe, With Air Tube, To 12000 lbs GVW, Right	10936 ☆③	10005③
95-96	10	8.0L	Dual Exhaust, 3" Pipe, To 12000 lbs GVW, Right	10981 ③	--
<b>DODGE RAM 50 PICKUP</b>					
87-89	4	2.0L		4203 ③	6904③
85-86	4	2.0L		--	6904③
90-92	4	2.4L		4377 ③	6904③
87-89	4	2.6L		4203 ③	6904③
85-86	4	2.6L		--	6904③
82-84	4	2.6L		--	6904③
79-81	4	All		--	6904③
90-91	6	All	4WD	--	6904③
<b>DODGE RAMCHARGER</b>					
1980	6	3.7L	Underbody	--	2905③
78-79	6	3.7L		--	6905③
75-80	8	5.2L		--	2906③
75-80	8	5.9L		--	2906③
1976	8	6.6L		--	8006③
92-93	8	All		--	2905③
90-91	8	All	4WD	--	2906③
89-91	8	All	2WD	--	2906③
80-88	8	All	2WD, Rear	--	2906③
80-88	8	All	4WD, Rear	--	2906③
<b>DODGE RAMPAGE</b>					
1984	4	2.2L		--	6004③
82-83	4	2.2L	Semi-Direct Fit, fabrication required - Outlet Pipe	--	6004③
<b>DODGE SHADOW</b>					
87-94	4	2.2L	(Exc. Turbo)	4051 ☆③	6004③
89-90	4	2.2L	Turbo	--	6906③
1988	4	2.2L	Turbo	--	6906③
1987	4	2.2L	Turbo	--	6905③
89-94	4	2.5L	(Exc. Turbo)	4051 ☆③	6004③
89-92	4	2.5L	Turbo	--	6004③
92-94	6	3.0L		4875 ③	6905③
<b>DODGE SPIRIT</b>					
91-92	4	2.2L	Turbo	--	6905③
89-95	4	2.5L	(Exc. Turbo)	4051 ☆③	6004③
89-92	4	2.5L	Turbo	--	6906③
92-95	6	3.0L		4875 ③	6905③
89-91	6	3.0L	Complete, w/Piping, Conv. includes Resonator	4223 ③	6906③
89-91	6	3.0L	Weld-in direct fit	--	6906③
<b>DODGE ST. REGIS</b>					
1981	6	3.7L	Rear	--	6005③
1981	6	3.7L	Main & Pre-Cat	--	6005③

☆ Air Tube kit 4948 may be required for installation.

③ Federal & California Emissions. Not For Sale or Use on vehicles licensed in the state of CA & NY (NY vehicles with CA Emissions). Check with your state authority for details.

YR/YRS	CYL	LITER	DESCRIPTION	DIRECT FIT	UNIVERSAL
<b>DODGE ST. REGIS (Cont.)</b>					
79-80	6	3.7L		--	6905③
80-81	8	5.2L	Rear	--	6905③
80-81	8	5.2L	Main & Pre-Cat	--	6005③
1980	8	5.9L		--	6005③
1979	8	All		--	6905③
<b>DODGE STEALTH</b>					
91-95	6	3.0L	Front	--	6904R③
91-95	6	3.0L		4377 ③	6904③
<b>DODGE STRATUS</b>					
98-00	4	2.0L		4225 ③	2504③
96-97	4	2.0L		4128 ③	2540③
2006	4	2.4L	Sedan & Convertible	4275 ③	2504R③
04-05	4	2.4L	Sedan & Convertible Exc. PZEV Emissions	4275 ③	2504R③
01-05	4	2.4L	Coupe, Front	1082 ③	--
01-05	4	2.4L	Coupe, Rear	4332 ③	2505③
01-03	4	2.4L	Sedan & Convertible	4275 ③	2504R③
95-00	4	2.4L		4859 ③	2505③
95-00	6	2.5L		4859 ③	2505③
01-06	6	2.7L	Manifold Unit, Front	4142 ③	--
01-06	6	2.7L	Rear Manifold Conv.	4143 ③	--
01-05	6	3.0L	Front Conv.	1094 ③	--
01-05	6	3.0L	Rear Conv.	1095 ③	--
01-05	6	3.0L	Main Rear	4393 ③	2540③
<b>DODGE VIPER</b>					
03-06	10	8.3L	3" System, Left	5149 ③	--
03-06	10	8.3L	3" System, Right	5150 ③	--
<b>EAGLE MEDALLION</b>					
88-89	4	2.2L		--	6904③
<b>EAGLE PREMIER</b>					
88-89	4	2.5L		4029 ③	6905③
88-92	6	3.0L		4029 ③	6905③
<b>EAGLE SUMMIT</b>					
93-95	4	1.5L		4377 ③	6904③
89-92	4	1.5L		4377 ③	6904③
89-90	4	1.6L	DOHC	4377 ③	6904③
93-94	4	1.8L		4377 ③	6904③
92-94	4	2.4L		--	6904③
<b>EAGLE TALON</b>					
95-98	4	2.0L		4359 ③	2504③
90-94	4	All		4377 ③	6904③
<b>EAGLE VISION</b>					
93-97	6	3.3L	Left Front, Federal Models	1093 ④	2538④
93-97	6	3.3L	Right Front, Federal Models	1092 ④	2538④
93-97	6	3.3L	For use with OE intermediate pipe, Main Conv., additional sizing, bushings, cutting may be required due to OE exhaust design.	4596 ②③	2513③
93-97	6	3.3L	For use with aftermarket intermediate pipe, Main Conv., additional sizing, bushings, cutting may be required due to OE exhaust design.	--	--
93-97	6	3.3L	For use with aftermarket intermediate pipe, Main Conv., additional sizing, bushings, cutting may be required due to OE exhaust design.	4596G ②③	2513③
93-97	6	3.3L	For use with aftermarket intermediate pipe, Main Conv., additional sizing, bushings, cutting may be required due to OE exhaust design.	--	--

② When using with aftermarket piping, direct fit converter may require INLET/OUTLET pipe resizing.

③ Federal & California Emissions. Not For Sale or Use on vehicles licensed in the state of CA & NY (NY vehicles with CA Emissions). Check with your state authority for details.

④ Federal Emissions. Not For Sale or Use on vehicles licensed in the state of CA. Check with your state authority.

# APPLICATION LISTINGS

## FEDERAL CONVERTERS



YR/YRS	CYL	LITER	DESCRIPTION	DIRECT FIT	UNIVERSAL
<b>EAGLE VISION (Cont.)</b>					
95-96	6	3.3L	Left, California Emissions & 3 Bolt Inlet Flanges	1090 ⑤	--
95-96	6	3.3L	Right, California Emissions & 3 Bolt Inlet Flanges	1091 ⑤	--
95-96	6	3.3L	For use with OE intermediate pipe, Rear Main, California Emissions additional sizing, bushings, cutting may be required due to OE exhaust design.	4596 ②⑤ -- --	2513 ⑤ -- --
95-96	6	3.3L	For use with aftermarket pipe, Rear Main, California Emissions, additional sizing, bushings, cutting may be required due to OE exhaust design.	4596G ②⑤ -- --	2513 ⑤ -- --
93-94	6	3.3L	Left, California Emissions & 3 Bolt Inlet Flanges	1090 ⑤	--
93-94	6	3.3L	Right, California Emissions & 3 Bolt Inlet Flanges	1091 ⑤	--
93-94	6	3.3L	For use with OE intermediate pipe, Rear Main, California Emissions, additional sizing, bushings, cutting may be required due to OE exhaust design.	4596 ②⑤ -- --	2908 ⑤ -- --
93-94	6	3.3L	For use with aftermarket intermediate pipe, Rear Main, California Emissions, additional sizing, bushings, cutting may be required due to OE exhaust design.	4596G ②⑤ -- --	2513 ⑤ -- --
1996	6	3.5L	Left Front	1047 ③	--
1996	6	3.5L	Right Front	1046 ③	--
1996	6	3.5L	Main Conv., additional sizing, bushings, cutting may be required due to OE exhaust design.	4418 ②③ --	2513 ③ --
93-95	6	3.5L	Left Front	1047 ③	--
93-95	6	3.5L	Right Front	1046 ③	--
93-95	6	3.5L	Main Conv., additional sizing, bushings, cutting may be required due to OE exhaust design.	4418 ②③ --	2908 ③ --
<b>EAGLE VISTA</b>					
89-92	4	1.5L	(Canada Model)	4377 ③	6904 ③
<b>FIAT 124</b>					
79-81	L4	2.0L		--	6903 ③
<b>FIAT BRAVA</b>					
80-81	L4	2.0L		--	6903 ③
<b>FIAT X-1/9</b>					
1980	4	1.5L	Exc. Fuel Injection	--	6903 ③
80-83	L4	1.5L	Fuel Injection	--	6903 ③
<b>FIAT STRADA</b>					
80-82	L4	1.5L	Fuel Injection	--	6903 ③
<b>FORD AEROSTAR</b>					
86-87	4	2.3L	Front	--	6904 ③
86-87	4	2.3L		--	6004 ③
86-87	4	2.3L	2 to 1 Conv. Replacement	--	9004 ③
1986	6	2.8L	Front	--	6904 ③
1986	6	2.8L		--	6004 ③
96-97	6	3.0L	Front	--	2516 ③
96-97	6	3.0L		--	2516 ③
94-95	6	3.0L	Front	--	6905 ③
94-95	6	3.0L		--	6905 ③
86-93	6	3.0L	Front	--	6904 ③
86-93	6	3.0L		--	6904 ③
86-93	6	3.0L	Complete Assembly	9009 ③	--

② When using with aftermarket piping, direct fit converter may require INLET/OUTLET pipe resizing.

③ Federal & California Emissions. Not For Sale or Use on vehicles licensed in the state of CA & NY (NY vehicles with CA Emissions). Check with your state authority for details.

⑤ California Emissions. Not For Sale or Use on vehicles licensed in the state of CA & NY. Check with your state authority.

YR/YRS	CYL	LITER	DESCRIPTION	DIRECT FIT	UNIVERSAL
<b>FORD AEROSTAR (Cont.)</b>					
90-97	6	4.0L	2WD & AWD, Front	--	2905③
90-97	6	4.0L	2WD & AWD, Rear	--	2905③
90-97	6	4.0L	2WD & AWD, Complete Assembly	9026 ③	--
<b>FORD ASPIRE</b>					
96-97	4	1.3L		4649 ③	2538③
94-95	4	1.3L		4649 ③	6804③
<b>FORD BRONCO</b>					
91-92	6	4.9L	Front, Dual Inlet	--	2913③
91-92	6	4.9L		--	2905③
91-92	6	4.9L	2 to 1 Conv. Replacement	--	2905③
87-90	6	4.9L	Front, Dual Inlet	--	2913③
87-90	6	4.9L		--	2905③
87-90	6	4.9L	2 to 1 Conv. Replacement	9651 ☆③	2905③
84-86	6	4.9L	Front	--	2905③
84-86	6	4.9L		--	2905③
84-86	6	4.9L	2 to 1 Conv. Replacement	--	2905③
80-83	6	4.9L		--	6005③
91-95	8	5.0L	Front, Dual Inlet	--	2913③
91-95	8	5.0L		--	2906③
91-95	8	5.0L	2 to 1 Conv. Replacement	9303 ☆③	2906③
85-90	8	5.0L	Front, Dual Inlet	--	2913③
85-90	8	5.0L		--	2906③
85-90	8	5.0L	2 to 1 Conv. Replacement	--	2906③
1984	8	5.0L	Front, Dual Inlet	--	2913③
1984	8	5.0L		--	2906③
1984	8	5.0L	2 to 1 Conv. Replacement	--	2906③
91-95	8	5.8L		--	9006③
91-95	8	5.8L	2 to 1 Conv. Replacement	--	2906③
88-90	8	5.8L	Front, Dual Inlet	--	2913③
88-90	8	5.8L		--	2906③
88-90	8	5.8L	2 to 1 Conv. Replacement	--	2906③
85-87	8	5.8L	Front, Dual Inlet, 4 bbl.	--	2913③
85-87	8	5.8L	Rear, 4 bbl	--	2906③
85-87	8	5.8L	4 bbl., 2 to 1 Conv. Replacement	--	2906③
84-85	8	5.8L	Front, Dual Inlet, 2 bbl.	--	2913③
84-85	8	5.8L	Rear, 2 bbl.	--	2906③
84-85	8	5.8L	2 bbl, 2 to 1 Conv. Replacement	--	2906③
80-83	8	All		--	6005③
78-79	8	All		--	8006③
<b>FORD BRONCO II</b>					
84-85	6	2.8L		--	6005③
1990	6	2.9L	Front	--	6905③
1990	6	2.9L		--	6905③
1990	6	2.9L	OEM Y-Pipe must be trimmed 1/2" from face of flange for proper insertion into converter.	9522 ③	--
1990	6	2.9L	2 to 1 Conv. Replacement	--	2905③
88-89	6	2.9L	Front	--	6905③

☆ Air Tube kit 4948 may be required for installation.

③ Federal & California Emissions. Not For Sale or Use on vehicles licensed in the state of CA & NY (NY vehicles with CA Emissions). Check with your state authority for details.

# APPLICATION LISTINGS

## FEDERAL CONVERTERS



YR/YRS	CYL	LITER	DESCRIPTION	DIRECT FIT	UNIVERSAL
<b>FORD BRONCO II (Cont.)</b>					
88-89	6	2.9L	Rear	--	6905③
88-89	6	2.9L	OEM Y-Pipe must be trimmed 1/2" from face of flange for proper insertion into converter.	9523 ③	--
88-89	6	2.9L	2 to 1 Conv. Replacement	--	2905③
86-87	6	2.9L	Front	--	2908③
86-87	6	2.9L	Rear	--	2905③
86-87	6	2.9L	2 to 1 Conv. Replacement	--	2905③
<b>FORD CONTOUR</b>					
98-00	4	2.0L	Eng. Code 3	4140 ③	--
95-97	4	2.0L		4878 ③	--
95-00	6	2.5L	Front Side Manifold Conv.	1012 ③	--
95-00	6	2.5L	Rear Side Manifold Conv.	1011 ③	--
95-00	6	2.5L	Rear, Auto Trans., w/O2 Sensor	4147 ③	2504③
95-00	6	2.5L	Main Conv., Manual Trans.	4860 ③	2505③
95-96	6	2.5L	Main Conv., Auto Trans., w/o O2 Sensor	4722 ③	6904③
<b>FORD CROWN VICTORIA (Inc. Police, Taxi, Station Wagon)</b>					
03-11	8	4.6L	Front Left	--	2554③
03-11	8	4.6L	Rear Left	--	2564③
03-11	8	4.6L	Front Right	--	2554③
03-11	8	4.6L	Rear Right	--	2564③
03-11	8	4.6L	Right	4803 ③	--
03-11	8	4.6L	Left	5002 ③	--
03-06	8	4.6L	Right	4270 ③①	--
03-06	8	4.6L	Left	4271 ③①	--
96-02	8	4.6L	Front Left	--	2554③
96-02	8	4.6L	Rear Left	--	2504③
96-02	8	4.6L	Right	4871 ③	--
96-02	8	4.6L	Left	4870 ③	--
96-02	8	4.6L	Front Right	--	2554③
96-02	8	4.6L	Rear Right	--	2504③
1995	8	4.6L	Right	4599 ③	2504③
1995	8	4.6L	Left	4598 ③	2504③
92-94	8	4.6L	Right, Main & Pre-Cat	4520 ③	6904③
92-94	8	4.6L	Left, Main & Pre-Cat	4521 ③	6904③
90-91	8	5.0L	Right Side, Main & Pre-Cat	4244 ☆③	6004③
90-91	8	5.0L	Left, Main & Pre-Cat	4245 ☆③	6004③
1989	8	5.0L	Right Side, Main & Pre-Cat	4244 ☆③	6004③
1989	8	5.0L	Left, Main & Pre-Cat	4245 ☆③	6004③
86-88	8	5.0L	Right Side, Main & Pre-Cat	4244 ☆③	6004③
86-88	8	5.0L	Left, Main & Pre-Cat	4245 ☆③	6004③
86-91	8	5.8L	Police Pkg., Right, Main & Pre-Cat	--	2904③
86-91	8	5.8L	Police Pkg., Left, Main & Pre-Cat	--	2904③
<b>FORD CUSTOM, CUSTOM 500</b>					
75-77	8	5.8L	Right	--	6904R③
75-77	8	5.8L	Left	--	6904R③

① Discontinued, use until inventory is depleted.

☆ Air Tube kit 4948 may be required for installation.

③ Federal & California Emissions. Not For Sale or Use on vehicles licensed in the state of CA & NY (NY vehicles with CA Emissions). Check with your state authority for details.

YR/YRS	CYL	LITER	DESCRIPTION	DIRECT FIT	UNIVERSAL
<b>FORD E-100 VAN</b>					
79-83	6	4.9L		--	6005③
77-78	6	4.9L		--	6905③
75-76	6	4.9L		--	6904③
1978	8	5.8L		--	6005③
1977	8	5.8L		--	6905③
75-76	8	5.8L		--	6005③
79-83	8	All		--	6006③
<b>FORD E-150 VAN 1/2 TON</b>					
00-03	6	4.2L	Left Side Complete, Only failed converters may be replaced.	9416 ③	--
00-03	6	4.2L	Right Side Complete, Only failed converters may be replaced.	9415 ③	--
97-03	6	4.2L	Front Right	--	2566③
97-03	6	4.2L	Rear Right	--	2540③
97-03	6	4.2L	Front Left	--	2566③
97-03	6	4.2L	Rear Left	--	2540③
1999	6	4.2L	Left Side Complete, Only failed converters may be replaced, Federal Emissions	9613 ④	--
1999	6	4.2L	Right Side Complete, Only failed converters may be replaced, Federal Emissions	9614 ④	--
1999	6	4.2L	Left Side Complete, Only failed converters may be replaced, California Emissions	9416 ⑤	--
1999	6	4.2L	Right Side Complete, Only failed converters may be replaced, California Emissions	9415 ⑤	--
97-98	6	4.2L	Left Side Complete, Only failed converters may be replaced.	9613 ③	--
97-98	6	4.2L	Right Side Complete, Only failed converters may be replaced.	9614 ③	--
1996	6	4.9L		9157 ③	--
1996	6	4.9L	Front	--	2513③
1996	6	4.9L	Rear	--	2526③
90-95	6	4.9L	Front, Dual Inlet	--	2913③
90-95	6	4.9L		--	2906③
90-95	6	4.9L	2 to 1 Conv. Replacement	9321 ☆③	2906③
87-89	6	4.9L	Under 8500 lbs GVW, Front, Dual Inlet	--	2913③
87-89	6	4.9L	Under 8500 lbs GVW, Rear	--	2906③
87-89	6	4.9L	Under 8500 lbs GVW, 2 to 1 Conv. Replacement	9321 ☆③	2906③
84-86	6	4.9L	Front	--	6905③
84-86	6	4.9L		--	6005③
84-86	6	4.9L	2 to 1 Conv. Replacement	--	2905③
79-83	6	4.9L		--	6005③
77-78	6	4.9L		--	6905③
75-76	6	4.9L		--	6904③
09-14	8	4.6L		9893 ③	--
07-08	8	4.6L	From 10/16/06, Complete Y Assembly w/4 Converters	9264 ③	--
04-07	8	4.6L	Rear Right	--	2540③
04-07	8	4.6L	Front Right	--	2566③
04-07	8	4.6L	Rear Left	--	2540③
04-07	8	4.6L	Front Left	--	2566③
00-07	8	4.6L	To 10/16/06, 2 Piece Design, Left	9986 ③	--
00-07	8	4.6L	To 10/16/06, 2 Piece Design, Right	9987 ③	--

☆ Air Tube kit 4948 may be required for installation.

③ Federal & California Emissions. Not For Sale or Use on vehicles licensed in the state of CA & NY (NY vehicles with CA Emissions). Check with your state authority for details.

④ Federal Emissions. Not For Sale or Use on vehicles licensed in the state of CA. Check with your state authority.

⑤ California Emissions. Not For Sale or Use on vehicles licensed in the state of CA & NY. Check with your state authority.

# APPLICATION LISTINGS

## FEDERAL CONVERTERS



YR/YRS	CYL	LITER	DESCRIPTION	DIRECT FIT	UNIVERSAL
<b>FORD E-150 VAN 1/2 TON (Cont.)</b>					
97-03	8	4.6L	Front Right	--	2566 <sup>③</sup>
97-03	8	4.6L	Rear Right	--	2516 <sup>③</sup>
97-03	8	4.6L	Front Left	--	2566 <sup>③</sup>
97-03	8	4.6L	Rear Left	--	2516 <sup>③</sup>
97-99	8	4.6L	Left	9417 <sup>③</sup>	--
97-99	8	4.6L	Right	9418 <sup>③</sup>	--
1996	8	5.0L	Front	--	2513 <sup>③</sup>
1996	8	5.0L		--	2516 <sup>③</sup>
1996	8	5.0L	Complete Assembly	9241 <sup>③</sup>	--
92-95	8	5.0L	Front, Dual Inlet	--	2913 <sup>③</sup>
92-95	8	5.0L		--	2906 <sup>③</sup>
92-95	8	5.0L	Complete Assembly	9241 <sup>③</sup>	--
86-91	8	5.0L	Front, Dual Inlet	--	2913 <sup>③</sup>
86-91	8	5.0L		--	2905 <sup>③</sup>
86-91	8	5.0L	2 to 1 Conv. Replacement	9390 ☆ <sup>③</sup>	2905 <sup>③</sup>
84-85	8	5.0L	w/Carb., Front Conv., Dual Inlet	--	2913 <sup>③</sup>
84-85	8	5.0L	w/Carb., Rear	--	2906 <sup>③</sup>
84-85	8	5.0L	w/Carb., 2 to 1 Conv. Replacement	--	2906 <sup>③</sup>
05-08	8	5.4L	Complete Assembly	9263 <sup>③</sup>	--
02-04	8	5.4L	Under 8600 lbs GVW, California Emissions, Front	1130 <sup>⑤</sup>	2565R <sup>⑤</sup>
02-04	8	5.4L	Under 8600 lbs GVW, California Emissions, Rear	10930 <sup>⑤</sup>	10907 <sup>⑤</sup>
88-95	8	5.8L	Front	--	2913 <sup>③</sup>
88-95	8	5.8L		--	2906 <sup>③</sup>
88-95	8	5.8L	2 to 1 Conv. Replacement	9202 ☆ <sup>③</sup>	2906 <sup>③</sup>
84-87	8	5.8L	Light Duty, Dual Inlet, 4 bbl. Carb., Front	--	2913 <sup>③</sup>
84-87	8	5.8L	Light Duty, 4 bbl. Carb., Rear	--	2906 <sup>③</sup>
84-87	8	5.8L	Light Duty, 4 bbl. Carb., 2 to 1 Conv. Replacement	--	2906 <sup>③</sup>
1978	8	5.8L		--	6005 <sup>③</sup>
1977	8	5.8L		--	6905 <sup>③</sup>
75-76	8	5.8L		--	6005 <sup>③</sup>
79-83	8	All		--	6006 <sup>③</sup>
<b>FORD E-250 VAN 3/4 TON</b>					
00-03	6	4.2L	Right Side Complete, Only failed converters may be replaced.	9415 <sup>③</sup>	--
00-03	6	4.2L	Left Side Complete, Only failed converters may be replaced.	9416 <sup>③</sup>	--
97-03	6	4.2L	Front Right	--	2566 <sup>③</sup>
97-03	6	4.2L	Rear Right	--	2540 <sup>③</sup>
97-03	6	4.2L	Front Left	--	2566 <sup>③</sup>
97-03	6	4.2L	Rear Left	--	2540 <sup>③</sup>
1999	6	4.2L	Right Side Complete, Only failed converters may be replaced, Federal Emissions	9614 <sup>④</sup>	--
1999	6	4.2L	Left Side Complete, Only failed converters may be replaced, Federal Emissions	9613 <sup>④</sup>	--
1999	6	4.2L	Right Side Complete, Only failed converters may be replaced, California Emissions	9415 <sup>⑤</sup>	--
1999	6	4.2L	Left Side Complete, Only failed converters may be replaced, California Emissions	9416 <sup>⑤</sup>	--
97-98	6	4.2L	Left Side Complete, Only failed converters may be replaced.	9613 <sup>③</sup>	--

☆ Air Tube kit 4948 may be required for installation.

③ Federal & California Emissions. Not For Sale or Use on vehicles licensed in the state of CA & NY (NY vehicles with CA Emissions). Check with your state authority for details.

④ Federal Emissions. Not For Sale or Use on vehicles licensed in the state of CA. Check with your state authority.

⑤ California Emissions. Not For Sale or Use on vehicles licensed in the state of CA & NY. Check with your state authority.



YR/YRS	CYL	LITER	DESCRIPTION	DIRECT FIT	UNIVERSAL
<b>FORD E-250 VAN 3/4 TON (Cont.)</b>					
97-98	6	4.2L	Right Side Complete, Only failed converters may be replaced.	9614 ③	--
1996	6	4.9L		9157 ③	--
1996	6	4.9L	Front	--	2516③
1996	6	4.9L		--	2526③
90-95	6	4.9L	Front, Dual Inlet	--	2913③
90-95	6	4.9L		--	2906③
90-95	6	4.9L	2 to 1 Conv. Replacement	9321 ☆③	2906③
87-89	6	4.9L	Under 8500 lbs GVW, Front, Dual Inlet	--	2913③
87-89	6	4.9L	Under 8500 lbs GVW, Rear	--	2906③
87-89	6	4.9L	Under 8500 lbs GVW, 2 to 1 Conv. Replacement	9321 ☆③	2906③
84-86	6	4.9L	Front	--	6905③
84-86	6	4.9L		--	6005③
84-86	6	4.9L	2 to 1 Conv. Replacement	--	2905③
79-83	6	4.9L		--	6005③
77-78	6	4.9L		--	6905③
75-76	6	4.9L		--	6904③
09-14	8	4.6L		9893 ③	--
07-08	8	4.6L	From 10/16/06, Complete Y Assembly w/4 Converters	9264 ③	--
04-07	8	4.6L	Rear Right	--	2540③
04-07	8	4.6L	Front Right	--	2566③
04-07	8	4.6L	Rear Left	--	2540③
04-07	8	4.6L	Front Left	--	2566③
03-07	8	4.6L	To 10/16/06, 2 Piece Design, Left	9986 ③	--
03-07	8	4.6L	To 10/16/06, 2 Piece Design, Right	9987 ③	--
2003	8	4.6L	Under 8500 lbs GVW, Front Right	--	2566③
2003	8	4.6L	Under 8500 lbs GVW, Rear Right	--	2516③
2003	8	4.6L	Under 8500 lbs GVW, Front Left	--	2566③
2003	8	4.6L	Under 8500 lbs GVW, Rear Left	--	2516③
1997	8	4.6L	Under 8500 lbs GVW, Front Right	--	2538③
1997	8	4.6L	Under 8500 lbs GVW, Rear Right	--	2516③
1997	8	4.6L	Under 8500 lbs GVW, Front Left	--	2538③
1997	8	4.6L	Under 8500 lbs GVW, Rear Left	--	2516③
86-91	8	5.0L	EFI, Front, Dual Inlet	--	2913③
86-91	8	5.0L	EFI, Rear	--	2906③
86-91	8	5.0L	EFI, 2 to 1 Conv. Replacement	9390 ☆③	2906③
84-85	8	5.0L	w/Carb., Front Conv., Dual Inlet	--	2913③
84-85	8	5.0L	w/Carb., Rear	--	2906③
84-85	8	5.0L	w/Carb., 2 to 1 Conv. Replacement	--	2906③
05-09	8	5.4L	Complete Assembly	9263 ③	--
02-04	8	5.4L	Under 8600 lbs GVW, California Emissions, Front	1130 ⑤	2565R⑤
02-04	8	5.4L	Under 8600 lbs GVW, California Emissions, Rear	10930 ⑤	10907⑤
97-03	8	5.4L	Under 8500 lbs GVW, Front Right	--	2538③
97-03	8	5.4L	Under 8500 lbs GVW, Rear Right	--	2516③
97-03	8	5.4L	Under 8500 lbs GVW, Front Left	--	2538③
97-03	8	5.4L	Under 8500 lbs GVW, Rear Left	--	2516③
97-99	8	5.4L	Over 8500 lbs GVW, Single Conv. System, w/o O2 Sensor	10920 ③	10907③
1996	8	5.8L	To 9200 lbs GVW	10973 ③	10006③

☆ Air Tube kit 4948 may be required for installation.

③ Federal & California Emissions. Not For Sale or Use on vehicles licensed in the state of CA & NY (NY vehicles with CA Emissions). Check with your state authority for details.

⑤ California Emissions. Not For Sale or Use on vehicles licensed in the state of CA & NY. Check with your state authority.

**APPLICATION LISTINGS  
FEDERAL CONVERTERS**



YR/YRS	CYL	LITER	DESCRIPTION	DIRECT FIT	UNIVERSAL
<b>FORD E-250 VAN 3/4 TON (Cont.)</b>					
92-95	8	5.8L	To 9200 lbs GVW	9900 ③	--
92-95	8	5.8L	To 11620 lbs GVW	10902 ③	10007③
88-95	8	5.8L	Under 8500 lbs GVW, Front, Dual Inlet	--	2913③
88-95	8	5.8L	Under 8500 lbs. GVW, Rear	--	2906③
88-95	8	5.8L	2 to 1 Conv. Replacement, Under 8500 lbs GVW	9202 ☆③	2906③
88-91	8	5.8L	To 9200 lbs GVW	9900 ③	--
88-91	8	5.8L	To 11620 lbs GVW	10902 ③	10007③
84-87	8	5.8L	4 bbl. Carb., Front, Dual Inlet	--	2913③
84-87	8	5.8L	4 bbl. Carb., Rear	--	2906③
84-87	8	5.8L	4 bbl. Carb., 2 to 1 Conv. Replacement	--	2906③
1978	8	5.8L		--	6905③
1977	8	5.8L		--	6905③
75-76	8	5.8L		--	6905③
80-81	8	6.6L		--	8006③
90-93	8	7.5L	To 9200 lbs GVW	9900 ③	--
90-93	8	7.5L	To 11620 lbs GVW	10902 ③	10007③
87-89	8	7.5L	To 9200 lbs GVW	9900 ③	--
87-89	8	7.5L	To 11620 lbs GVW	10902 ③	10007③
79-83	8	All	(Exc. 400 C.I.D.)	--	6006③
<b>FORD E-350 VAN 1 TON</b>					
1996	6	4.9L		9157 ③	--
1996	6	4.9L	Under 8600 lbs GVW, Front	--	2513③
1996	6	4.9L	Under 8600 lbs GVW, Rear	--	2526③
90-95	6	4.9L	Up to 8600 lbs GVW, Front, Dual Inlet	--	2913③
90-95	6	4.9L	Up to 8600 lbs GVW, Rear	--	2906③
90-95	6	4.9L	2 to 1 Conv. Replacement, Up to 8600 lbs GVW	9321 ☆③	2906③
87-89	6	4.9L	Front, Dual Inlet	--	2913③
87-89	6	4.9L		--	2906③
87-89	6	4.9L	2 to 1 Conv. Replacement	9321 ☆③	2906③
84-86	6	4.9L	Front	--	2905③
84-86	6	4.9L		--	2905③
84-86	6	4.9L	2 to 1 Conv. Replacement	--	2905③
1983	6	4.9L		--	2905③
05-09	8	5.4L	Complete Assembly	9263 ③	--
07-08	8	5.4L	From 10/2006, Super Duty, Stripped Chassis, OEM Torpedo Style, Rear	10933 ③	--
97-98	8	5.4L	Over 8500 lbs GVW, w/o O2 Sensor	10920 ☆③	10007③
1996	8	5.8L	To 9200 lbs GVW	10973 ☆③	10906③
90-95	8	5.8L		9900 ③	--
88-89	8	5.8L	To 8500 lbs GVW	9900 ③	--
88-89	8	5.8L	To 11620 lbs GVW	10902 ③	10007③
1987	8	5.8L	4 bbl. Carb., Front, Dual Inlet	--	2913③
1987	8	5.8L	4 bbl. Carb., Rear	--	2906③
1987	8	5.8L	4 bbl. Carb., 2 to 1 Conv. Replacement	--	2906③
90-95	8	7.5L	To 8500 lbs GVW	9900 ③	--
90-95	8	7.5L	To 11620 lbs GVW	10902 ③	10007③
88-89	8	7.5L	To 8500 lbs GVW	9900 ③	--

☆ Air Tube kit 4948 may be required for installation.

③ Federal & California Emissions. Not For Sale or Use on vehicles licensed in the state of CA & NY (NY vehicles with CA Emissions). Check with your state authority for details.

YR/YRS	CYL	LITER	DESCRIPTION	DIRECT FIT	UNIVERSAL
<b>FORD E-350 VAN 1 TON (Cont.)</b>					
88-89	8	7.5L	To 11620 lbs GVW	10902 ③	10007③
1987	8	7.5L	To 8500 lbs GVW	9900 ③	--
1987	8	7.5L	To 11620 lbs GVW	10902 ③	10007③
84-86	8	All		--	9005③
07-08	10	6.8L	From 10/2006, Super Duty, Stripped Chassis, OEM Torpedo Style, Rear	10933 ③	--
06-07	10	6.8L		10926 ③	10907③
01-05	10	6.8L		--	10907③
97-00	10	6.8L	Over 8500 lbs GVW, w/Curved Outlet Pipe, Federal Emissions	10922 ④	10907④
97-00	10	6.8L	Over 8500 lbs GVW, w/Curved Outlet Pipe & O2 Sensor, California Emissions	10925 ⑤	10907⑤
97-00	10	6.8L	Stripped Chassis	10928 ③	--
97-98	10	6.8L	Over 8500 lbs GVW, w/Straight Outlet Pipe, w/o O2 Sensor	10920 ☆③	10907③
<b>FORD E-450 VAN</b>					
2008	8	5.4L	OEM Torpedo Style, Rear	10933 ③	--
2006	8	5.4L	Super Duty, Cutaway Van, OEM Torpedo Style	10937 ③	--
2006	8	5.4L	Super Duty, Stripped Chassis, OEM Torpedo Style	10937 ③	--
2004	8	5.4L	Super Duty, Stripped Chassis, OEM Torpedo Style	10937 ③	--
03-04	8	5.4L	Super Duty, Cutaway Van, OEM Torpedo Style	10937 ③	--
00-02	8	5.4L	Super Duty, Cutaway Van, OEM Torpedo Style	10937 ③	--
2008	10	6.8L	OEM Torpedo Style, Rear	10933 ③	--
06-07	10	6.8L	From 10/16/06, With 3 Bolt Flange on Inlet	10926 ③	10907③
04-07	10	6.8L	Up to 10/16/06, Up to 14,050 lbs.	10927 ③	--
04-06	10	6.8L	Super Duty, Stripped Chassis, OEM Torpedo Style	10937 ③	--
04-06	10	6.8L	Super Duty, Cutaway Van, OEM Torpedo Style	10937 ③	--
2003	10	6.8L	Super Duty, Cutaway Van, OEM Torpedo Style	10937 ③	--
00-02	10	6.8L	Super Duty, Cutaway Van, OEM Torpedo Style	10937 ③	--
<b>FORD E-550 SUPER DUTY</b>					
2003	10	6.8L	Super Duty, Cutaway Van, OEM Torpedo Style	10937 ③	--
<b>FORD EDGE</b>					
11-14	6	3.5L	Manifold Unit, Front Left	1285 ③	--
11-13	6	3.5L	Manifold Unit, Front Right	1286 ③	--
07-10	6	3.5L	Front Conv.	4454 ③	--
07-10	6	3.5L	Rear Conv.	4455 ③	--
11-14	6	3.7L	Manifold Unit, Front Left	1285 ③	--
<b>FORD ESCAPE</b>					
06-08	4	2.3L	Front Manifold Conv., From 10/03/05; XLS & XLT, Exc. Hybrid	1136 ③	--
05-08	4	2.3L	Rear Main	9408 ③	--
09-12	4	2.5L	XLS, XLT, Limited; Exc. Hybrid; Requires Welded Assembly 60005 to Complete Assembly	9981 ③	--
10-12	6	3.0L	Manifold Unit, Front Right	1289 ③	--
09-12	6	3.0L	Manifold Unit, Front Left	1288 ③	--
09-12	6	3.0L	Rear	9530 ③	--
2008	6	3.0L	Manifold Unit, Front Left	1283 ③	--
05-06	6	3.0L	Rear Main	9408 ③	--
01-06	6	3.0L	Manifold Unit, Front	1148 ③	--
01-06	6	3.0L	Rear Manifold Conv.	1147 ③	--

☆ Air Tube kit 4948 may be required for installation.

③ Federal & California Emissions. Not For Sale or Use on vehicles licensed in the state of CA & NY (NY vehicles with CA Emissions). Check with your state authority for details.

④ Federal Emissions. Not For Sale or Use on vehicles licensed in the state of CA. Check with your state authority.

⑤ California Emissions. Not For Sale or Use on vehicles licensed in the state of CA & NY. Check with your state authority.

**APPLICATION LISTINGS**  
**FEDERAL CONVERTERS**



YR/YRS	CYL	LITER	DESCRIPTION	DIRECT FIT	UNIVERSAL
<b>FORD ESCAPE (Cont.)</b>					
01-04	6	3.0L	Rear Main	9008 ③	2504③
<b>FORD ESCORT</b>					
83-85	4	1.6L		--	6004③
81-82	4	1.6L		--	6004③
91-95	4	1.8L		--	6904③
1996	4	1.9L		4604 ③	2538③
91-95	4	1.9L	w/EGR Port on Conv.	4612 ③	2538③
91-95	4	1.9L	w/o EGR Port on Conv.	4113 ③	2538③
87-90	4	1.9L	C.F.I.	--	6804③
86-90	4	1.9L	E.F.I.	4122 ☆③	--
85-86	4	1.9L	2 bbl. Carb.	--	6004③
98-03	4	2.0L	ZX2 Models w/ Auto Trans.	4202 ③	2539③
97-02	4	2.0L	(Exc. ZX2)	4865 ③	2538③
<b>FORD EXCURSION</b>					
00-02	8	5.4L	Up to 12,000 lbs GVW w/o Rear O2 Sensor, Federal Emissions	10924 ④	10907④
00-02	10	6.8L	Up to 12,000 lbs GVW w/o Rear O2 Sensor, Federal Emissions	10924 ④	10907④
<b>FORD EXP</b>					
83-84	4	1.6L		--	6004③
1982	4	1.6L		--	6004③
<b>FORD EXPEDITION</b>					
03-04	8	4.6L	Right	9190 ③	--
03-04	8	4.6L	Left	9191 ③	--
03-04	8	4.6L	Front Right	--	2566③
03-04	8	4.6L	Rear Right	--	2516③
03-04	8	4.6L	Front Left	--	2566③
03-04	8	4.6L	Rear Left	--	2516③
01-02	8	4.6L	Front Right	--	2566③
01-02	8	4.6L	Rear Right	--	2516③
01-02	8	4.6L	Front Left	--	2566③
01-02	8	4.6L	Rear Left	--	2516③
01-02	8	4.6L	4WD, Left	9482 ③	--
01-02	8	4.6L	4WD, Right	9483 ③	--
2000	8	4.6L	Left, 2WD	9117 ③	--
2000	8	4.6L	Right, 2WD	9116 ③	--
99-00	8	4.6L	4WD, Left	9097 ③	--
99-00	8	4.6L	4WD, Right	9096 ③	--
97-00	8	4.6L	2WD, Front, Right	--	2566③
97-00	8	4.6L	2WD, Rear, Right	--	2516③
97-00	8	4.6L	2WD, Front, Left	--	2566③
97-00	8	4.6L	2WD, Rear, Left	--	2516③
97-98	8	4.6L	4WD, Front Right	--	2566③
97-98	8	4.6L	4WD, Rear, Right	--	2540③
97-98	8	4.6L	4WD, Front Left	--	2566③
97-98	8	4.6L	4WD, Rear Left	--	2540③
07-14	8	5.4L	Left	9984 ③	--
07-14	8	5.4L	Right	9985 ③	--
05-06	8	5.4L	Left	9353 ③	--

☆ Air Tube kit 4948 may be required for installation.

③ Federal & California Emissions. Not For Sale or Use on vehicles licensed in the state of CA & NY (NY vehicles with CA Emissions). Check with your state authority for details.

④ Federal Emissions. Not For Sale or Use on vehicles licensed in the state of CA. Check with your state authority.

YR/YRS	CYL	LITER	DESCRIPTION	DIRECT FIT	UNIVERSAL
<b>FORD EXPEDITION (Cont.)</b>					
05-06	8	5.4L	Right	9352 ③	--
03-04	8	5.4L	Right	9248 ③	--
03-04	8	5.4L	Left	9249 ③	--
03-04	8	5.4L	Front Right	--	2565③
03-04	8	5.4L	Rear Right	--	2506R③
03-04	8	5.4L	Front Left	--	2565③
03-04	8	5.4L	Rear Left	--	2506R③
01-02	8	5.4L	Right, 4WD	9250 ③	--
01-02	8	5.4L	Left, 4WD	9251 ③	--
01-02	8	5.4L	4WD, Front Right	--	2566③
01-02	8	5.4L	4WD, Rear, Right	--	2506③
01-02	8	5.4L	2WD, Front, Right	--	2566③
01-02	8	5.4L	2WD, Rear, Right	--	2516③
01-02	8	5.4L	4WD, Front Left	--	2566③
01-02	8	5.4L	4WD, Rear Left	--	2506③
01-02	8	5.4L	2WD, Front, Left	--	2566③
01-02	8	5.4L	2WD, Rear, Left	--	2516③
97-00	8	5.4L	4WD, Front Right	--	2545③
97-00	8	5.4L	4WD, Rear, Right	--	2540③
97-00	8	5.4L	Complete Right Assembly, 4WD, 4R100 Trans.	9050 ③	--
97-00	8	5.4L	Complete Left Assembly, 4WD, 4R100 Trans.	9051 ③	--
97-00	8	5.4L	2WD, Front, Right	--	2566③
97-00	8	5.4L	2WD, Rear, Right	--	2516③
97-00	8	5.4L	4WD, Front Left	--	2545③
97-00	8	5.4L	4WD, Rear Left	--	2540③
97-00	8	5.4L	2WD, Front, Left	--	2566③
97-00	8	5.4L	2WD, Rear, Left	--	2516③
<b>FORD EXPLORER</b>					
11-13	6	3.5L	Manifold Unit, Front Left	1285 ③	--
11-13	6	3.5L	Manifold Unit, Front Right	1286 ③	--
07-10	6	4.0L	Sport Trac, Complete Assembly	9172 ③	--
07-10	6	4.0L	Sport Trac, Right	--	2565R③
07-10	6	4.0L	Sport Trac, Left	--	2565R③
06-10	6	4.0L	Complete Assembly	9172 ③	--
06-10	6	4.0L	Left	--	2565R③
06-10	6	4.0L	Right	--	2565R③
04-05	6	4.0L	Sport Trac, VIN K, Front	1282 ③	--
04-05	6	4.0L	Sport Trac, VIN K, Rear	9467 ③	--
02-05	6	4.0L	Code E Eng., Front Convs.	--	2504R③
02-05	6	4.0L	Code E Eng., Rear	--	2516③
02-05	6	4.0L	Code E Eng., Complete Assembly	9112 ③	--
02-04	6	4.0L	Code K Eng., Front Convs.; To 3/1/04	--	2504R③
02-04	6	4.0L	Code K Eng., Rear; To 3/1/04	--	2516③
02-04	6	4.0L	Code K Eng., Complete Assembly; To 3/1/04	9112 ③	--
01-02	6	4.0L	Sport Models, Code E Eng., Front Conv. w/Y Pipe	1044 ③	--
01-02	6	4.0L	Sport Models, Code E Eng., 1st or 2nd Rear Conv.	--	2516③
01-02	6	4.0L	Sport Models, Code E Eng., Rear Conv., Complete Assembly	9244 ③	--

③ Federal & California Emissions. Not For Sale or Use on vehicles licensed in the state of CA & NY (NY vehicles with CA Emissions). Check with your state authority for details.

**APPLICATION LISTINGS**  
**FEDERAL CONVERTERS**



YR/YRS	CYL	LITER	DESCRIPTION	DIRECT FIT	UNIVERSAL
<b>FORD EXPLORER (Cont.)</b>					
01-02	6	4.0L	Sport Trac, Code E Eng., Front Conv. w/Y Pipe	1044 ③	--
01-02	6	4.0L	Sport Trac, Code E Eng., 1st or 2nd Rear Conv.	--	2516③
01-02	6	4.0L	Sport Trac, Code E Eng., Rear Conv., Complete Assembly	9244 ③	--
2001	6	4.0L	Code "K", w/Dual Inlet Pipe Muffler, Left	4045 ③	2505R③
2001	6	4.0L	Code "K", w/Dual Inlet Pipe Muffler, Right Conv. w/Left Side Extension Pipe	4044A ③	2540③
2001	6	4.0L	Code "K", w/Dual Inlet Pipe Muffler, Right Conv. w/o Left Side Extension Pipe	4044 ③	2505③
98-01	6	4.0L	LEV Code "E" Eng., w/Single Inlet Pipe Muffler, Front Convs., California Emissions	1044 ⑤	--
98-01	6	4.0L	LEV Code "E" Eng., w/Single Inlet Pipe Muffler, Rear Convs., California Emissions	9244 ⑤	--
97-01	6	4.0L	Code "E" w/Dual Inlet Pipe Muffler, Left	4045 ③	2505R③
97-01	6	4.0L	Code "E", w/Dual Inlet Pipe Muffler, Right Conv. w/Left Side Extension Pipe	4044A ③	2540③
97-01	6	4.0L	Code "E", w/Dual Inlet Pipe Muffler, Right Conv. w/o Left Side Extension Pipe	4044 ③	2505③
99-00	6	4.0L	Code "X" Eng., Front Conv. w/Y Pipe	1160 ③	--
99-00	6	4.0L	Code "X" Eng., Front	--	2516③
99-00	6	4.0L	Code "X" Eng., Rear	--	2516③
99-00	6	4.0L	Code "X" Eng., Complete Assembly, Rear	9160 ③	--
96-98	6	4.0L	Code "X" Front	--	2516③
96-98	6	4.0L	Code "X" Rear	--	2516③
96-98	6	4.0L	Code "X" Complete Assembly	9060 ③	--
1995	6	4.0L	Front	--	2906③
1995	6	4.0L		--	2906③
1995	6	4.0L	Complete Assembly	9060 ③	--
91-94	6	4.0L	Front	--	6905③
91-94	6	4.0L		--	6905③
91-94	6	4.0L	2 to 1 Conv. Replacement, OEM Y-Pipe must be trimmed 1/2" from face of flange for proper insertion into converter.	9522 ③	2905③
07-10	8	4.6L	Sport Trac, Complete Assembly	4582 ③	--
06-10	8	4.6L	Complete Assembly	4582 ③	--
02-05	8	4.6L	Complete Assembly	9173 ③	--
02-05	8	4.6L	Front Right	--	2504R③
02-05	8	4.6L	Rear Universal	--	2516③
02-05	8	4.6L	Front Left	--	2504R③
98-00	8	5.0L	Left; From 2/98	4868 ③	--
98-00	8	5.0L	Right; From 2/98	4869 ③	--
96-98	8	5.0L	Front Right; To 1/98	4881 ③	--
96-98	8	5.0L	Front Left; To 1/98	4882 ③	--
96-98	8	5.0L	Rear Left; To 1/98	--	2515③
96-98	8	5.0L	Rear Right; To 1/98	--	2515③
96-98	8	5.0L	Complete Rear Assembly; To 1/98	9029 ③	--
<b>FORD F-100 PICKUP 1/2 TON</b>					
75-79	6	4.9L		--	6904③
80-83	6	All		--	6005③

③ Federal & California Emissions. Not For Sale or Use on vehicles licensed in the state of CA & NY (NY vehicles with CA Emissions). Check with your state authority for details.  
 ⑤ California Emissions. Not For Sale or Use on vehicles licensed in the state of CA & NY. Check with your state authority.

YR/YRS	CYL	LITER	DESCRIPTION	DIRECT FIT	UNIVERSAL
<b>FORD F-100 PICKUP 1/2 TON (Cont.)</b>					
81-82	8	4.2L		--	6005③
81-82	8	4.2L	California Emissions	--	6005⑤
80-83	8	5.0L	Federal Emissions	--	6005④
80-83	8	5.0L	California Emissions	--	6005⑤
75-79	8	5.0L		--	6904③
1981	8	5.8L		--	6005③
<b>FORD F-150 PICKUP 1/2 TON</b>					
11-14	6	3.7L	Left	9525 ③	--
11-14	6	3.7L	Right	9526 ③	--
05-08	6	4.2L	Left	9259 ③	--
05-08	6	4.2L	Right, Auto Trans.	9258 ③	--
2004	6	4.2L	Right, 2WD, (Heritage)	9422 ③	--
2004	6	4.2L	Left, 2WD, (Heritage)	9423 ③	--
2004	6	4.2L	Rear Left, (Heritage)	--	2516③
2004	6	4.2L	Front Left, (Heritage)	--	2566③
2004	6	4.2L	Rear Right, (Heritage)	--	2516③
2004	6	4.2L	Front Right, (Heritage)	--	2566③
2004	6	4.2L	Heritage, 4WD, Left	9465 ③	--
2004	6	4.2L	Heritage, 4WD, Right	9466 ③	--
00-03	6	4.2L	Left, 2WD	9079 ③⑩	--
			Left, 2WD	9423 ③	--
00-03	6	4.2L	Right, 2WD	9078 ③⑩	--
			Right, 2WD	9422 ③	--
00-03	6	4.2L	Front Right	--	2566③
00-03	6	4.2L	Rear Right	--	2516③
00-03	6	4.2L	Front Left	--	2566③
00-03	6	4.2L	Rear Left	--	2516③
00-03	6	4.2L	4WD, Left	9465 ③	--
00-03	6	4.2L	4WD, Right	9466 ③	--
99-00	6	4.2L	4WD, California Emissions, Left	9484 ⑤	--
99-00	6	4.2L	4WD, California Emissions, Right	9485 ⑤	--
1999	6	4.2L	4WD, Front Right	--	2566③
1999	6	4.2L	4WD, Rear, Right	--	2516③
1999	6	4.2L	4WD, Front Left	--	2566③
1999	6	4.2L	4WD, Rear Left	--	2516③
97-99	6	4.2L	RWD, With 2 Converters, Left	9079 ③⑩	--
			RWD, With 2 Converters, Left	9423 ③	--
97-99	6	4.2L	RWD, With 2 Converters, Right	9078 ③⑩	--
			RWD, With 2 Converters, Right	9422 ③	--
97-99	6	4.2L	2WD, Front, Right	--	2566③
97-99	6	4.2L	2WD, Rear, Right	--	2516③
97-99	6	4.2L	2WD, Front, Left	--	2566③
97-99	6	4.2L	2WD, Rear, Left	--	2516③
97-98	6	4.2L	4WD, Complete Assembly, Right	9242 ③	--
97-98	6	4.2L	4WD, Complete Assembly, Left	9243 ③	--
97-98	6	4.2L	4WD, Front Right	--	2566③
97-98	6	4.2L	4WD, Rear, Right	--	2516③

⑩ Discontinued, use until inventory is depleted.

③ Federal & California Emissions. Not For Sale or Use on vehicles licensed in the state of CA & NY (NY vehicles with CA Emissions). Check with your state authority for details.

④ Federal Emissions. Not For Sale or Use on vehicles licensed in the state of CA. Check with your state authority.

⑤ California Emissions. Not For Sale or Use on vehicles licensed in the state of CA & NY. Check with your state authority.

# APPLICATION LISTINGS

## FEDERAL CONVERTERS



YR/YRS	CYL	LITER	DESCRIPTION	DIRECT FIT	UNIVERSAL
<b>FORD F-150 PICKUP 1/2 TON (Cont.)</b>					
97-98	6	4.2L	4WD, Front Left	--	2566 <sup>③</sup>
97-98	6	4.2L	4WD, Rear Left	--	2516 <sup>③</sup>
97-98	6	4.2L	RWD, With 1 Converter, Left	9463 <sup>③</sup>	--
97-98	6	4.2L	RWD, With 1 Converter, Right	9464 <sup>③</sup>	--
1996	6	4.9L	Front, 2WD	--	2513 <sup>③</sup>
1996	6	4.9L	Rear, 2WD	--	2526 <sup>③</sup>
1996	6	4.9L	2WD	9082 <sup>③</sup>	--
1996	6	4.9L	Front, 4WD	--	2513 <sup>③</sup>
1996	6	4.9L	Rear, 4WD	--	2526 <sup>③</sup>
87-95	6	4.9L	Front, Dual Inlet	--	2913 <sup>③</sup>
87-95	6	4.9L		--	2906 <sup>③</sup>
87-95	6	4.9L	2 to 1 Conv. Replacement	9651 ☆ <sup>③</sup>	2906 <sup>③</sup>
84-86	6	4.9L	Front	--	6905 <sup>③</sup>
84-86	6	4.9L		--	6005 <sup>③</sup>
84-86	6	4.9L	2 to 1 Conv. Replacement	--	2905 <sup>③</sup>
80-83	6	4.9L		--	6005 <sup>③</sup>
75-79	6	All		--	6904 <sup>③</sup>
09-10	8	4.6L	RWD, 16 Valve Engine, Left	9498 <sup>③</sup>	--
09-10	8	4.6L	RWD, 16 Valve Engine, Right	9499 <sup>③</sup>	--
09-10	8	4.6L	4WD, 24 Valve Engine, Left	9551 <sup>③</sup>	--
09-10	8	4.6L	4WD, 24 Valve Engine, Right	9552 <sup>③</sup>	--
06-08	8	4.6L	Right	--	2578R <sup>③</sup>
06-08	8	4.6L	Left	--	2578R <sup>③</sup>
06-08	8	4.6L	4WD, Left	9527 <sup>③</sup>	--
06-08	8	4.6L	4WD, Right	9528 <sup>③</sup>	--
05-08	8	4.6L	RWD, Left	9488 <sup>③</sup>	--
05-08	8	4.6L	RWD, Right	9489 <sup>③</sup>	--
04-05	8	4.6L	To 8/8/05, 2WD, Right, (2004 New Body Style), With 2 Conv. Bodies	9260 <sup>③</sup>	--
04-05	8	4.6L	To 8/8/05, 2WD, Left, (2004 New Body Style), With 2 Conv. Bodies	9261 <sup>③</sup>	--
2004	8	4.6L	RWD, With 1 Converter, Left	9488 <sup>③</sup>	--
2004	8	4.6L	RWD, With 1 Converter, Right	9489 <sup>③</sup>	--
01-03	8	4.6L	2WD, Rear, Right	--	2516 <sup>③</sup>
01-03	8	4.6L	2WD, Complete Assembly, Right	9116 <sup>③</sup>	--
01-03	8	4.6L	2WD, Front, Right	--	2566 <sup>③</sup>
01-03	8	4.6L	2WD, Rear, Right	--	2516 <sup>③</sup>
01-03	8	4.6L	2WD, Complete Assembly, Left	9117 <sup>③</sup>	--
01-03	8	4.6L	4WD, Rear, Right	--	2516 <sup>③</sup>
01-03	8	4.6L	4WD, Front Right	--	2566 <sup>③</sup>
01-03	8	4.6L	4WD, Rear, Right	--	2516 <sup>③</sup>
01-03	8	4.6L	2WD, Front, Left	--	2566 <sup>③</sup>
01-03	8	4.6L	2WD, Rear, Left	--	2516 <sup>③</sup>
01-03	8	4.6L	4WD, Front Left	--	2566 <sup>③</sup>
01-03	8	4.6L	4WD, Rear Left	--	2516 <sup>③</sup>
01-02	8	4.6L	4WD, Left	9482 <sup>③</sup>	--
01-02	8	4.6L	4WD, Right	9483 <sup>③</sup>	--
99-00	8	4.6L	2WD, Right	9056 <sup>③</sup>	--
99-00	8	4.6L	2WD, Left	9057 <sup>③</sup>	--

☆ Air Tube kit 4948 may be required for installation.

③ Federal & California Emissions. Not For Sale or Use on vehicles licensed in the state of CA & NY (NY vehicles with CA Emissions). Check with your state authority for details.



YR/YRS	CYL	LITER	DESCRIPTION	DIRECT FIT	UNIVERSAL
<b>FORD F-150 PICKUP 1/2 TON (Cont.)</b>					
99-00	8	4.6L	2WD, Front, Right	--	2566③
99-00	8	4.6L	2WD, Rear, Right	--	2516③
99-00	8	4.6L	4WD, Front Right	--	2566③
99-00	8	4.6L	4WD, Rear, Right	--	2516③
99-00	8	4.6L	2WD, Front, Left	--	2566③
99-00	8	4.6L	2WD, Rear, Left	--	2516③
99-00	8	4.6L	4WD, Front Left	--	2566③
99-00	8	4.6L	4WD, Rear Left	--	2516③
97-00	8	4.6L	4WD, Right	9096 ③	--
97-00	8	4.6L	4WD, Left	9097 ③	--
97-98	8	4.6L	2WD, Right	9056 ③	--
97-98	8	4.6L	2WD, Left	9057 ③	--
97-98	8	4.6L	Front Right	--	2566③
97-98	8	4.6L	Rear Right	--	2516③
97-98	8	4.6L	Front Left	--	2566③
97-98	8	4.6L	Rear Left	--	2516③
11-14	8	5.0L	Left	9532 ③	--
11-14	8	5.0L	Right	9533 ③	--
1996	8	5.0L	Front	--	2513③
1996	8	5.0L		--	2526③
1996	8	5.0L	Complete Assembly	9396 ☆③	--
85-95	8	5.0L	EFI Eng., Front, Dual Inlet	--	2913③
85-95	8	5.0L	EFI Eng., Rear	--	2906③
85-95	8	5.0L	EFI Eng., 2 to 1 Conv. Replacement	9302 ③	2906③
84-85	8	5.0L	(Exc. EFI), Front, Dual Inlet	--	2913③
84-85	8	5.0L	(Exc. EFI), Rear	--	2906③
84-85	8	5.0L	(Exc. EFI), 2 to 1 Conv. Replacement	--	2906③
1983	8	5.0L	Single Conv. System	--	2905③
80-82	8	5.0L		--	2906③
75-79	8	5.0L		--	6904③
09-10	8	5.4L	Left	9984 ③	--
09-10	8	5.4L	Right	9985 ③	--
05-08	8	5.4L	2WD, Right	9256 ③	2571R③
05-08	8	5.4L	2WD, Left	9257 ③	2571R③
04-08	8	5.4L	4WD, Right, (2004 New Body Style)	9268 ③	2571R③
04-08	8	5.4L	4WD, Left, (2004 New Body Style)	9269 ③	2571R③
04-06	8	5.4L	4WD, w/ 2 Converters, California Emissions, Base Payload, To 8/8/05, Left	9468 ⑤	--
04-06	8	5.4L	4WD, w/ 2 Converters, California Emissions, Base Payload, To 8/8/05, Right	9469 ⑤	--
04-05	8	5.4L	RWD, With 2 Converters, Left	9480 ③	--
04-05	8	5.4L	RWD, With 2 Converters, Right	9481 ③	--
2004	8	5.4L	Heritage SVT Lightning, Left	9496 ③	--
2004	8	5.4L	Heritage SVT Lightning, Right	9497 ③	--
01-04	8	5.4L	4WD, Right, w/ Rear O2 sensor port between converter bodies. (2004 Old Body Style)	9084 ③	--

☆ Air Tube kit 4948 may be required for installation.

③ Federal & California Emissions. Not For Sale or Use on vehicles licensed in the state of CA & NY (NY vehicles with CA Emissions). Check with your state authority for details.

⑤ California Emissions. Not For Sale or Use on vehicles licensed in the state of CA & NY. Check with your state authority.

# APPLICATION LISTINGS

## FEDERAL CONVERTERS



YR/YRS	CYL	LITER	DESCRIPTION	DIRECT FIT	UNIVERSAL
<b>FORD F-150 PICKUP 1/2 TON (Cont.)</b>					
01-04	8	5.4L	4WD, Left, w/ Rear O2 sensor port between converter bodies. (2004 Old Body Style)	9085 ③	--
01-04	8	5.4L	4WD, Front Right, (2004 Old Body Style)	--	2566③
01-04	8	5.4L	4WD, Rear Right, (2004 Old Body Style)	--	2516③
01-04	8	5.4L	4WD, Front Left, (2004 Old Body Style)	--	2566③
01-04	8	5.4L	4WD, Rear Left, (2004 Old Body Style)	--	2516③
01-03	8	5.4L	Lightning, Harley-Davidson Edition, 4R100 Trans. Mfg Code, Left	9496 ③	--
01-03	8	5.4L	Lightning, Harley-Davidson Edition, 4R100 Trans. Mfg Code, Right	9497 ③	--
01-02	8	5.4L	2WD, Front, Left	--	2566③
01-02	8	5.4L	2WD, Rear, Left	--	2516③
01-02	8	5.4L	2WD, 4R70W Trans., Complete Assembly, Right	9136 ③	--
01-02	8	5.4L	2WD, 4R70W Trans., Complete Assembly, Left	9137 ③	--
01-02	8	5.4L	2WD, Front, Right	--	2566③
01-02	8	5.4L	2WD, Rear, Right	--	2516③
98-00	8	5.4L	4WD, 4R100 Trans., Right	9050 ③	--
98-00	8	5.4L	4WD, 4R100 Trans., Left	9051 ③	--
98-00	8	5.4L	4WD, 4R70W Trans., Right	9236 ③	--
98-00	8	5.4L	4WD, 4R70W Trans., Left	9237 ③	--
97-00	8	5.4L	2WD & 4WD, Front Left	--	2566③
97-00	8	5.4L	2WD & 4WD, Rear Left	--	2516③
97-00	8	5.4L	2WD & 4WD, Front Right	--	2566③
97-00	8	5.4L	2WD & 4WD, Rear Right	--	2516③
1996	8	5.8L	Front	--	2513③
1996	8	5.8L		--	2526③
1995	8	5.8L	Front, Dual Inlet	--	2913③
1995	8	5.8L		--	2906③
1995	8	5.8L	2 to 1 Conv. Replacement	9650 ☆③	2906③
88-94	8	5.8L	Front, Dual Inlet	--	2913③
88-94	8	5.8L		--	2906③
88-94	8	5.8L	2 to 1 Conv. Replacement	9650 ☆③	2906③
84-86	8	5.8L	Front, Dual Inlet	--	2913③
84-86	8	5.8L		--	2906③
84-86	8	5.8L	2 to 1 Conv. Replacement	--	2906③
82-83	8	5.8L	Front, Dual Inlet	--	2913③
82-83	8	5.8L		--	2906③
82-83	8	5.8L	2 to 1 Conv. Replacement	--	2906③
80-81	8	5.8L		--	2906③
77-79	8	5.8L		--	2905③
77-79	8	6.6L		--	8005③
<b>FORD F-250 PICKUP 3/4 TON</b>					
1996	6	4.9L	Front, 2WD	--	2513③
1996	6	4.9L	Rear, 2WD	--	2526③
1996	6	4.9L	2WD	9082 ③	--
1996	6	4.9L	Front, 4WD	--	2513③
1996	6	4.9L	Rear, 4WD	--	2526③
87-95	6	4.9L	Front, Dual Inlet	--	2913③
87-95	6	4.9L		--	2906③

☆ Air Tube kit 4948 may be required for installation.

③ Federal & California Emissions. Not For Sale or Use on vehicles licensed in the state of CA & NY (NY vehicles with CA Emissions). Check with your state authority for details.

YR/YRS	CYL	LITER	DESCRIPTION	DIRECT FIT	UNIVERSAL
<b>FORD F-250 PICKUP 3/4 TON (Cont.)</b>					
87-95	6	4.9L	2 to 1 Conv. Replacement	9651 ☆③	2906③
84-86	6	4.9L	Front	--	6905③
84-86	6	4.9L		--	6005③
84-86	6	4.9L	2 to 1 Conv. Replacement	--	2905③
80-83	6	4.9L		--	6005③
75-79	6	All		--	6904③
97-98	8	4.6L	2WD, Right	9056 ③	--
97-98	8	4.6L	2WD, Left	9057 ③	--
1996	8	5.0L	Front, Dual Inlet	--	2513③
1996	8	5.0L		--	2526③
1996	8	5.0L	2 to 1 Conv. Replacement	9396 ☆③	--
85-95	8	5.0L	EFI Eng., Front, Dual Inlet	--	2913③
85-95	8	5.0L	EFI Eng., Rear	--	2906③
85-95	8	5.0L	EFI Eng., 2 to 1 Conv. Replacement	9302 ☆③	2906③
84-85	8	5.0L	(Exc. EFI), Front, Dual Inlet	--	2913③
84-85	8	5.0L	(Exc. EFI), Rear	--	2906③
84-85	8	5.0L	(Exc. EFI), 2 to 1 Conv. Replacement	--	2906③
1983	8	5.0L	Single Conv. System	--	2905③
80-82	8	5.0L		--	2906③
75-79	8	5.0L		--	6904③
08-10	8	5.4L	Super Duty	9477 ③	--
05-07	8	5.4L	Complete Y Assembly	4634 ③	--
05-07	8	5.4L	Super Duty, w/ Center O2 Port, OEM Torpedo Style, Rear	10932 ③	--
05-07	8	5.4L	Super Duty, w/o Center O2 Port, OEM Torpedo Style	10938 ③	--
01-03	8	5.4L	4WD, Front Left	--	2566③
01-03	8	5.4L	4WD, Rear, Right	--	2516③
01-03	8	5.4L	4WD, Front Right	--	2566③
01-03	8	5.4L	4WD, Rear Left	--	2516③
00-03	8	5.4L	To 12000 lbs GVW, w/o Rear O2 Sensor, Federal Emissions	10924 ④	10907④
1999	8	5.4L	Single Conv. System, To 12000 lbs GVW, w/o O2 Sensor	10920 ☆③	10907③
1999	8	5.4L	Super Duty, w/ O2 Sensor Port, Federal Emissions, OEM Torpedo Style	10931 ④	--
98-99	8	5.4L	Dual Conv. System, 4WD, 4R100 Trans., To 8600 lbs GVW, Right	9050 ③	--
98-99	8	5.4L	Dual Conv. System, 4WD, 4R100 Trans., To 8600 lbs GVW, Left	9051 ③	--
98-99	8	5.4L	Dual Conv. System, 4WD, 4R70W Trans., Exc. Super Duty, Right	9236 ③	--
98-99	8	5.4L	Dual Conv. System, 4WD, 4R70W Trans., Exc. Super Duty, Left	9237 ③	--
97-99	8	5.4L	Dual Conv. System, To 8600 lbs GVW, Front Right	--	2566③
97-99	8	5.4L	Dual Conv. System, To 8600 lbs GVW, Rear Right	--	2516③
97-99	8	5.4L	Dual Conv. System, To 8600 lbs GVW, Front Left	--	2566③
97-99	8	5.4L	Dual Conv. System, To 8600 lbs GVW, Rear Left	--	2516③
1998	8	5.4L	To 12000 lbs GVW	10902 ③	10007③
96-97	8	5.8L	To 9200 lbs GVW, w/ 2-1/2" Outlet Pipe	9900 ③	--
96-97	8	5.8L	To 9200 lbs GVW, w/ 3" Outlet Pipe	9902 ③	--
96-97	8	5.8L	To 12000 lbs GVW, w/ 2-1/2" Outlet Pipe	10902 ③	10007③
96-97	8	5.8L	To 12000 lbs GVW, w/ 3" Outlet Pipe	10901 ③	--
1996	8	5.8L	Light Duty, Front	--	2513③
1996	8	5.8L	Light Duty, Rear	--	2526③

☆ Air Tube kit 4948 may be required for installation.

③ Federal & California Emissions. Not For Sale or Use on vehicles licensed in the state of CA & NY (NY vehicles with CA Emissions). Check with your state authority for details.

④ Federal Emissions. Not For Sale or Use on vehicles licensed in the state of CA. Check with your state authority.

**APPLICATION LISTINGS  
FEDERAL CONVERTERS**



YR/YRS	CYL	LITER	DESCRIPTION	DIRECT FIT	UNIVERSAL
<b>FORD F-250 PICKUP 3/4 TON (Cont.)</b>					
1995	8	5.8L	Light Duty, Front, Dual Inlet	--	2913③
1995	8	5.8L	Light Duty, Rear	--	2906③
1995	8	5.8L	Light Duty, 2 to 1 Conv. Replacement	9650 ☆③	2906③
94-95	8	5.8L	To 9200 lbs GVW, (Exc. 4 Bolt Flange Inlet)	9901 ③	9007③
94-95	8	5.8L	To 9200 lbs GVW, 4 Bolt Flange Inlet, w/ 2-1/2" Outlet Pipe	9900 ③	--
94-95	8	5.8L	To 9200 lbs GVW, 4 Bolt Flange Inlet, w/ 3" Outlet Pipe	9902 ③	--
94-95	8	5.8L	To 12000 lbs GVW, 4 Bolt Flange Inlet, w/ 2-1/2" Outlet Pipe	10902 ③	10007③
94-95	8	5.8L	To 12000 lbs GVW, 4 Bolt Flange Inlet, w/ 3" Outlet Pipe	10901 ③	--
94-95	8	5.8L	To 12000 lbs GVW, (Exc. 4 Bolt Flange Inlet)	10900 ③	10007③
94-95	8	5.8L	California Emissions, To 9200 lbs GVW, (Exc. 4 Bolt Flange Inlet)	9901 ⑤	9007⑤
94-95	8	5.8L	California Emissions, To 9200 lbs GVW, 4 Bolt Flange Inlet	9900 ⑤	--
88-94	8	5.8L	Light Duty, Front, Dual Inlet	--	2913③
88-94	8	5.8L	Light Duty, Rear	--	2906③
88-94	8	5.8L	Light Duty, 2 to 1 Conv. Replacement	9650 ☆③	2906③
87-93	8	5.8L	To 9200 lbs GVW, 4 Bolt Flange Inlet, w/ 2-1/2" Outlet Pipe	9900 ③	--
87-93	8	5.8L	To 9200 lbs GVW, 4 Bolt Flange Inlet, w/ 3" Outlet Pipe	9902 ③	--
87-93	8	5.8L	To 12000 lbs GVW, 4 Bolt Flange Inlet, w/ 2-1/2" Outlet Pipe	10902 ③	10007③
87-93	8	5.8L	To 12000 lbs GVW, 4 Bolt Flange Inlet, w/ 3" Outlet Pipe	10901 ③	--
87-93	8	5.8L	To 9200 lbs GVW, California Emissions	9900 ⑤	--
87-93	8	5.8L	To 9200 lbs GVW, (Exc. 4 Bolt Flange Inlet)	9901 ③	9007③
87-93	8	5.8L	To 12000 lbs GVW, (Exc. 4 Bolt Flange Inlet)	10900 ③	10007③
87-93	8	5.8L	To 9200 lbs GVW, California Emissions, 4 Bolt Flange Inlet	9900 ⑤	--
84-86	8	5.8L	Front, Dual Inlet	--	2913③
84-86	8	5.8L		--	2906③
84-86	8	5.8L	2 to 1 Conv. Replacement	--	2906③
82-83	8	5.8L	Front, Dual Inlet	--	2913③
82-83	8	5.8L		--	2906③
82-83	8	5.8L	2 to 1 Conv. Replacement	--	2906③
80-81	8	5.8L		--	2906③
77-79	8	5.8L		--	2905③
1980	8	6.6L		--	8006③
77-79	8	6.6L		--	8005③
96-97	8	7.5L	To 9200 lbs GVW, w/ 2-1/2" Outlet Pipe	9900 ③	--
96-97	8	7.5L	To 9200 lbs GVW, w/ 3" Outlet Pipe	9902 ③	--
96-97	8	7.5L	To 12000 lbs GVW, w/ 2-1/2" Outlet Pipe	10902 ③	10007③
96-97	8	7.5L	To 12000 lbs GVW, w/ 3" Outlet Pipe	10901 ③	--
94-95	8	7.5L	To 9200 lbs GVW, (Exc. 4 Bolt Flange Inlet)	9901 ③	9007③
94-95	8	7.5L	To 9200 lbs GVW, 4 Bolt Flange Inlet, w/ 2-1/2" Outlet Pipe	9900 ③	--
94-95	8	7.5L	To 9200 lbs GVW, 4 Bolt Flange Inlet, w/ 3" Outlet Pipe	9902 ③	--
94-95	8	7.5L	To 12000 lbs GVW, 4 Bolt Flange Inlet, w/ 2-1/2" Outlet Pipe	10902 ③	10007③
94-95	8	7.5L	To 12000 lbs GVW, 4 Bolt Flange Inlet, w/ 3" Outlet Pipe	10901 ③	--
94-95	8	7.5L	To 12000 lbs GVW, (Exc. 4 Bolt Flange Inlet)	10900 ③	10007③
87-93	8	7.5L	To 9200 lbs GVW, 4 Bolt Flange Inlet, w/ 2-1/2" Outlet Pipe	9900 ③	--
87-93	8	7.5L	To 9200 lbs GVW, 4 Bolt Flange Inlet, w/ 3" Outlet Pipe	9902 ③	--
87-93	8	7.5L	To 12000 lbs GVW, 4 Bolt Flange Inlet, w/ 2-1/2" Outlet Pipe	10902 ③	10007③
87-93	8	7.5L	To 12000 lbs GVW, 4 Bolt Flange Inlet, w/ 3" Outlet Pipe	10901 ③	--
87-93	8	7.5L	To 9200 lbs GVW, (Exc. 4 Bolt Flange Inlet)	9901 ☆③	9007③

☆ Air Tube kit 4948 may be required for installation.

③ Federal & California Emissions. Not For Sale or Use on vehicles licensed in the state of CA & NY (NY vehicles with CA Emissions). Check with your state authority for details.

⑤ California Emissions. Not For Sale or Use on vehicles licensed in the state of CA & NY. Check with your state authority.

YR/YRS	CYL	LITER	DESCRIPTION	DIRECT FIT	UNIVERSAL
<b>FORD F-250 PICKUP 3/4 TON (Cont.)</b>					
87-93	8	7.5L	To 12000 lbs GVW, (Exc. 4 Bolt Flange Inlet)	10900 ☆③	10007③
1979	8	7.5L		--	8006③
08-10	10	6.8L	Super Duty	9477 ③	--
05-07	10	6.8L	Super Duty, w/ Center O2 Port, OEM Torpedo Style, Rear	10932 ③	--
05-07	10	6.8L	Super Duty, w/o Center O2 Port, OEM Torpedo Style	10938 ③	--
99-03	10	6.8L	To 12000 lbs GVW, w/o Rear O2 Sensor, Federal Emissions	10924 ④	10907④
1999	10	6.8L	Super Duty, w/ O2 Sensor Port, Federal Emissions, OEM Torpedo Style	10931 ④	--
				--	--
<b>FORD F-350 PICKUP 1 TON</b>					
1996	6	4.9L	Front, 2WD	--	2513③
1996	6	4.9L	Rear, 2WD	--	2526③
1996	6	4.9L	Front & Rear, 2WD	9082 ③	--
87-95	6	4.9L	Under 8500 lbs GVW, Front, Dual Inlet	--	2913③
87-95	6	4.9L	Under 8500 lbs GVW, Rear	--	2906③
87-95	6	4.9L	Under 8500 lbs GVW, 2 to 1 Conv. Replacement	9651 ☆③	2906③
84-86	6	4.9L	Under 8500 lbs GVW, Front	--	2905③
84-86	6	4.9L	Under 8500 lbs GVW, Rear	--	2905③
84-86	6	4.9L	Under 8500 lbs GVW, 2 to 1 Conv. Replacement	--	2905③
81-83	6	4.9L	Under 8500 lbs GVW	--	2905③
08-10	8	5.4L	Super Duty	9477 ③	--
07-08	8	5.4L	Rear Main Conv. After Converter Y Pipe Assembly	--	10907③
05-07	8	5.4L	Super Duty, w/ Center O2 Port, OEM Torpedo Style, Rear	10932 ③	--
05-07	8	5.4L	Super Duty, w/o Center O2 Port, OEM Torpedo Style	10938 ③	--
05-06	8	5.4L	Complete Assembly, 41" OAL, 2WD	9246 ③	--
2004	8	5.4L	Super Duty Cab & Chassis, Up To 9,900 lbs. GVW	10904 ③	--
99-03	8	5.4L	To 12000 lbs GVW, w/o Rear O2 Sensor, Federal Emissions	10924 ④	10907④
88-97	8	5.8L	To 9200 lbs GVW, 4 Bolt Flange Inlet, w/ 2-1/2" Outlet Pipe	9900 ③	--
88-97	8	5.8L	To 9200 lbs GVW, 4 Bolt Flange Inlet, w/ 3" Outlet Pipe	9902 ③	--
88-97	8	5.8L	To 12000 lbs GVW, 4 Bolt Flange Inlet, w/ 2-1/2" Outlet Pipe	10902 ③	10007③
88-97	8	5.8L	To 12000 lbs GVW, 4 Bolt Flange Inlet, w/ 3" Outlet Pipe	10901 ③	--
88-97	8	5.8L	To 9200 lbs GVW, (Exc. 4 Bolt Flange Inlet)	9901 ③	9007③
88-97	8	5.8L	To 12,000 lbs GVW, (Exc. 4 Bolt Flange Inlet)	10900 ③	10007③
88-95	8	5.8L	To 9200 lbs GVW, (Exc. 4 Bolt Flange Inlet), California Emissions	9901 ⑤	9007⑤
88-95	8	5.8L	To 9200 lbs GVW, 4 Bolt Flange Inlet, California Emissions	9900 ⑤	--
87-89	8	5.8L	To 9200 lbs GVW	9900 ③	--
87-89	8	5.8L	To 12000 lbs GVW	10902 ③	10007③
88-97	8	7.5L	To 9200 lbs GVW, 4 Bolt Flange Inlet, w/ 2-1/2" Outlet Pipe	9900 ③	--
88-97	8	7.5L	To 9200 lbs GVW, 4 Bolt Flange Inlet, w/ 3" Outlet Pipe	9902 ③	--
88-97	8	7.5L	To 12000 lbs GVW, 4 Bolt Flange Inlet, w/ 2-1/2" Outlet Pipe	10902 ③	10007③
88-97	8	7.5L	To 12000 lbs GVW, 4 Bolt Flange Inlet, w/ 3" Outlet Pipe	10901 ③	--
88-97	8	7.5L	To 9200 lbs GVW, (Exc. 4 Bolt Flange Inlet)	9901 ③	9007③
88-97	8	7.5L	To 12,000 lbs GVW, (Exc. 4 Bolt Flange Inlet)	10900 ③	10007③
87-89	8	7.5L	To 9200 lbs GVW	9900 ③	--
87-89	8	7.5L	To 12000 lbs GVW	10902 ③	10007③
08-10	10	6.8L	Super Duty	9477 ③	--
07-08	10	6.8L	Rear Main Conv. After Converter Y Pipe Assembly	--	10907③
05-07	10	6.8L	Super Duty, w/ Center O2 Port, OEM Torpedo Style, Rear	10932 ③	--

☆ Air Tube kit 4948 may be required for installation.

③ Federal & California Emissions. Not For Sale or Use on vehicles licensed in the state of CA & NY (NY vehicles with CA Emissions). Check with your state authority for details.

④ Federal Emissions. Not For Sale or Use on vehicles licensed in the state of CA. Check with your state authority.

⑤ California Emissions. Not For Sale or Use on vehicles licensed in the state of CA & NY. Check with your state authority.

**APPLICATION LISTINGS  
FEDERAL CONVERTERS**



YR/YRS	CYL	LITER	DESCRIPTION	DIRECT FIT	UNIVERSAL
<b>FORD F-350 PICKUP 1 TON (Cont.)</b>					
05-07	10	6.8L	Super Duty, w/o Center O2 Port, OEM Torpedo Style	10938 ③	--
99-03	10	6.8L	To 12000 lbs GVW, w/o Rear O2 Sensor, Federal Emissions	10924 ④	10907④
1999	10	6.8L	To 12000 lbs GVW, w/O2 Sensor	10923 ③	10907③
1999	10	6.8L	To 12000 lbs GVW, w/o O2 Sensor	10920 ③	10907③
1999	10	6.8L	Super Duty, w/ O2 Sensor Port, Federal Emissions, OEM Torpedo Style	10931 ④	--
				--	--
<b>FORD F-450 PICKUP 1-1/2 TON</b>					
94-95	8	7.5L	To 12000 lbs GVW	10901 ③	10007③
90-93	8	7.5L	To 12000 lbs GVW	10902 ③	10007③
05-07	10	6.8L	Super Duty, w/ Center O2 Port, OEM Torpedo Style, Rear	10932 ③	--
05-07	10	6.8L	Super Duty, w/o Center O2 Port, OEM Torpedo Style	10938 ③	--
04-07	10	6.8L		--	10907③
2003	10	6.8L		--	10907③
1999	10	6.8L		10923 ③	--
1999	10	6.8L	Super Duty, w/ O2 Sensor Port, Federal Emissions, OEM Torpedo Style	10931 ④	--
				--	--
<b>FORD F-550 SUPER DUTY</b>					
05-07	10	6.8L	W/ Center O2 Port, OEM Torpedo Style, Rear	10932 ③	--
05-07	10	6.8L	W/O Center O2 Port, OEM Torpedo Style	10938 ③	--
<b>FORD FAIRMONT, FUTURA</b>					
1983	4	2.3L	39" Conv.	--	6004③
81-83	4	2.3L	(Exc. 39" Conv.)	--	6005③
78-80	4	2.3L	17" Conv.	--	6904③
78-83	6	3.3L	Rear	--	6904③
78-83	6	3.3L	Main & Pre-Cat	--	6004③
1982	8	4.2L	w/23" Rear Conv.	--	6005③
1982	8	4.2L	Main & Pre-Cat, 23" Rear Conv.	--	6004③
1982	8	4.2L	w/25" Conv., Rear	--	6004③
1982	8	4.2L	Main & Pre-Cat, 25" Rear Conv.	--	6004③
1981	8	4.2L		--	6005③
1981	8	4.2L	Main & Pre-Cat	--	6004③
1980	8	4.2L		--	6904③
1980	8	4.2L	Main & Pre-Cat	--	6004③
78-79	8	5.0L	Rear	--	6904③
<b>FORD FESTIVA</b>					
90-93	4	1.3L		--	6804③
88-89	4	1.3L	w/Air Tube	--	6004③
88-89	4	1.3L	w/o Air Tube	4377 ③	6904③
<b>FORD FIESTA</b>					
78-80	4	1.6L		--	6904③
<b>FORD FIVE HUNDRED</b>					
05-07	6	3.0L	Front, 2WD	4390 ③	--
05-07	6	3.0L	Front, AWD	4490 ③	--
05-07	6	3.0L		4391 ③	--
05-07	6	3.0L	Rear Main Conv.	4392 ③	2565③○

③ Federal & California Emissions. Not For Sale or Use on vehicles licensed in the state of CA & NY (NY vehicles with CA Emissions). Check with your state authority for details.  
 ④ Federal Emissions. Not For Sale or Use on vehicles licensed in the state of CA. Check with your state authority.  
 ○ EPA Enhanced OBDII By Design Unit

YR/YRS	CYL	LITER	DESCRIPTION	DIRECT FIT	UNIVERSAL
<b>FORD FLEX</b>					
09-10	6	3.5L	Rear Main Conv.	--	2565R <sup>③</sup> ○
09-10	6	3.5L	To 03/09/10, Non-Turbo, Engine Code "C", Front	4454 <sup>③</sup>	--
09-10	6	3.5L	To 03/09/10, Non-Turbo, Engine Code "C", Rear	4455 <sup>③</sup>	--
<b>FORD FOCUS</b>					
09-10	4	2.0L	Auto Trans., Exc. PZEV, Manifold Unit, Front	1287 <sup>③</sup>	--
05-08	4	2.0L	Models w/ Air Manifold	1138 <sup>③</sup>	--
05-07	4	2.0L	Front, California Emissions w/o Air Manifold	1121 <sup>⑤</sup>	--
05-07	4	2.0L	Rear, California Emission	4338 <sup>⑤</sup>	2574R <sup>⑤</sup> ○
			Rear, California Emission	--	2564R <sup>⑤</sup> □
03-04	4	2.0L	SVT, Engine Code 5, Manual Trans., Rear	--	2538 <sup>③</sup>
03-04	4	2.0L	SVT, Engine Code 5, Manual Trans., Front	--	2538 <sup>③</sup>
02-04	4	2.0L	SVT, Code "5" Engine, Front	5153 <sup>③</sup>	--
00-04	4	2.0L	Code "P" Engine	4972 <sup>③</sup>	--
00-04	4	2.0L	Code "3" Eng. & Auto Trans.	4400 <sup>③</sup>	--
00-04	4	2.0L	Code "3" Eng. & Man Trans.	4300 <sup>③</sup>	2538 <sup>③</sup>
05-07	4	2.3L	Front, California Emissions w/o Air Manifold	1121 <sup>⑤</sup>	--
05-07	4	2.3L	Rear, California Emission	4338 <sup>⑤</sup>	2574R <sup>⑤</sup> ○
			Rear, California Emission	--	2564R <sup>⑤</sup> □
04-07	4	2.3L	Front, w/ Air Manifold	1138 <sup>③</sup>	--
03-04	4	2.3L		4338 <sup>③</sup>	2574R <sup>③</sup>
<b>FORD FREESTAR</b>					
04-07	6	3.9L		4372 <sup>③</sup>	--
04-07	6	4.2L		4372 <sup>③</sup>	--
<b>FORD FREESTYLE</b>					
05-07	6	3.0L	Front	4490 <sup>③</sup>	--
05-07	6	3.0L		4391 <sup>③</sup>	--
05-07	6	3.0L	Rear Main Conv.	4392 <sup>③</sup>	2565 <sup>③</sup>
<b>FORD FUSION</b>					
2009	4	2.3L	Rear, Federal Emissions	4338 <sup>④</sup>	2574R <sup>④</sup>
07-09	4	2.3L	With Air Tube, Auto Trans., California Emissions, Front	1202 <sup>⑤</sup>	--
06-09	4	2.3L	Front Manifold Conv., FWD, Federal Emissions, From 09/04/06	4638 <sup>④</sup>	--
10-12	6	3.0L	Front Right	1284 <sup>③</sup>	--
06-12	6	3.0L	Manifold Unit, Front Left	1211 <sup>③</sup>	--
			Manifold Unit, Front Left	1122 <sup>③</sup> ○	--
07-08	6	3.0L	Rear Manifold Conv., AWD, 09-04-06 to 12-03-07	1145 <sup>③</sup>	--
06-08	6	3.0L	Rear Main Conv., FWD	4453 <sup>③</sup>	2545 <sup>③</sup>
06-08	6	3.0L	Rear Manifold Conv., FWD	1123 <sup>③</sup>	--
06-08	6	3.0L	Rear Main Conv., AWD	4453 <sup>③</sup>	2545 <sup>③</sup>
2010	6	3.5L	Rear Conv.	4455 <sup>③</sup>	--
2010	6	3.5L	Front Conv.	4454 <sup>③</sup>	--
<b>FORD GRANADA</b>					
81-82	4	2.3L	(Exc. w/22" Rear Conv.), Front	--	6904R <sup>③</sup>
81-82	4	2.3L	(Exc. w/22" Rear Conv.), Rear	--	6904 <sup>③</sup>
81-82	4	2.3L	(Exc. w/22" Rear Conv.), Main & Pre-Cat	--	6004 <sup>③</sup>
81-82	4	2.3L	w/22" Rear Conv., Front	--	6904R <sup>③</sup>
81-82	4	2.3L	w/22" Rear Conv., Rear	--	6005 <sup>③</sup>
81-82	4	2.3L	w/22" Rear Conv., Main & Pre-Cat	--	6004 <sup>③</sup>

○ Discontinued, use until inventory is depleted.

③ Federal & California Emissions. Not For Sale or Use on vehicles licensed in the state of CA & NY (NY vehicles with CA Emissions). Check with your state authority for details.

④ Federal Emissions. Not For Sale or Use on vehicles licensed in the state of CA. Check with your state authority.

⑤ California Emissions. Not For Sale or Use on vehicles licensed in the state of CA & NY. Check with your state authority.

128 □ EPA OBDII By Design Unit

○ EPA Enhanced OBDII By Design Unit

**APPLICATION LISTINGS**  
**FEDERAL CONVERTERS**



YR/YRS	CYL	LITER	DESCRIPTION	DIRECT FIT	UNIVERSAL
<b>FORD GRANADA (Cont.)</b>					
81-82	6	3.3L	Rear	--	6904 <sup>ⓐ</sup>
81-82	6	3.3L	Main & Pre-Cat	--	6004 <sup>ⓐ</sup>
1982	6	3.8L	w/22" Conv., Rear	--	6005 <sup>ⓐ</sup>
1982	6	3.8L	w/22" Conv., Main & Pre-Cat	--	6004 <sup>ⓐ</sup>
1982	6	3.8L	w/25" Conv., Rear	--	6904 <sup>ⓐ</sup>
1982	6	3.8L	w/25" Conv., Main & Pre-Cat	--	6004 <sup>ⓐ</sup>
1980	6	4.1L	(Exc. w/14-1/4" Rear Conv.), Rear	--	6004 <sup>ⓐ</sup>
1980	6	4.1L	(Exc. w/14-1/4" Rear Conv.), Main & Pre-Cat	--	6004 <sup>ⓐ</sup>
78-80	6	4.1L	w/14-1/4" Conv., Rear	--	6905 <sup>ⓐ</sup>
77-79	6	4.1L	w/18" Conv.	--	6905 <sup>ⓐ</sup>
75-76	6	All		--	6904 <sup>ⓐ</sup>
1981	8	4.2L	w/22" Rear Conv., Rear	--	6005 <sup>ⓐ</sup>
1981	8	4.2L	w/22" Rear Conv., Main & Pre-Cat	--	6004 <sup>ⓐ</sup>
77-79	8	5.0L	(Exc. w/18" Conv.)	--	6905 <sup>ⓐ</sup>
77-79	8	5.0L	w/18" Conv.	--	6905 <sup>ⓐ</sup>
75-76	8	5.0L		--	6905 <sup>ⓐ</sup>
1977	8	5.8L	Left	--	6904R <sup>ⓐ</sup>
1977	8	5.8L	Right	--	6904R <sup>ⓐ</sup>
75-76	8	5.8L	Left	--	6904R <sup>ⓐ</sup>
75-76	8	5.8L	Right	--	6904R <sup>ⓐ</sup>
1980	8	All		--	6905 <sup>ⓐ</sup>
<b>FORD LTD FULL SIZE</b>					
81-82	8	4.2L	Right	--	6004 <sup>ⓐ</sup>
81-82	8	4.2L	Left	--	6004 <sup>ⓐ</sup>
81-85	8	5.0L	Right	--	6004 <sup>ⓐ</sup>
81-85	8	5.0L	Left	--	6004 <sup>ⓐ</sup>
77-78	8	5.0L	Right	--	6904R <sup>ⓐ</sup>
77-78	8	5.0L	Left	--	6904R <sup>ⓐ</sup>
83-85	8	5.8L	Right	--	2904 <sup>ⓐ</sup>
83-85	8	5.8L	Left	--	2904 <sup>ⓐ</sup>
81-82	8	5.8L	Right	--	2904 <sup>ⓐ</sup>
81-82	8	5.8L	Left	--	2904 <sup>ⓐ</sup>
75-78	8	5.8L		--	6904R <sup>ⓐ</sup>
75-78	8	5.8L	Left	--	6904R <sup>ⓐ</sup>
75-78	8	6.6L	Right	--	9004 <sup>ⓐ</sup>
75-78	8	6.6L	Left	--	9004 <sup>ⓐ</sup>
79-80	8	All	Right	--	6004 <sup>ⓐ</sup>
79-80	8	All	Left	--	6004 <sup>ⓐ</sup>
<b>FORD LTD II</b>					
77-79	8	All	Left	--	6904R <sup>ⓐ</sup>
77-79	8	All	Right	--	6904R <sup>ⓐ</sup>
<b>FORD LTD MIDSIZE</b>					
84-86	4	2.3L	w/39" Conv.	--	6004 <sup>ⓐ</sup>
1983	4	2.3L	Front	--	6904R <sup>ⓐ</sup>
1983	4	2.3L		--	6904 <sup>ⓐ</sup>
1983	4	2.3L	Main & Pre-Cat	--	6004 <sup>ⓐ</sup>
1983	6	3.3L	Rear	--	6904 <sup>ⓐ</sup>

<sup>ⓐ</sup> Federal & California Emissions. Not For Sale or Use on vehicles licensed in the state of CA & NY (NY vehicles with CA Emissions). Check with your state authority for details.



YR/YRS	CYL	LITER	DESCRIPTION	DIRECT FIT	UNIVERSAL
<b>FORD LTD MIDSIZE (Cont.)</b>					
1983	6	3.3L	Main & Pre-Cat	--	6004 <sup>③</sup>
84-86	6	3.8L	w/ Fuel Injection, Rear	--	6005 <sup>③</sup>
84-86	6	3.8L	w/ Fuel Injection, Main & Pre-Cat	--	6005 <sup>③</sup>
1984	6	3.8L	w/EEC, Rear	--	6904 <sup>③</sup>
1984	6	3.8L	w/EEC, Main & Pre-Cat	--	6005 <sup>③</sup>
1984	6	3.8L	Rear, (Exc. Fuel Injection & EEC)	--	6005 <sup>③</sup>
1984	6	3.8L	(Exc. Fuel Injection & EEC), Main & Pre-Cat	--	6004 <sup>③</sup>
1983	6	3.8L		--	6005 <sup>③</sup>
1983	6	3.8L	Main & Pre-Cat	--	6004 <sup>③</sup>
<b>FORD MAVERICK</b>					
75-76	6	All		--	6905 <sup>③</sup>
75-76	8	All		--	6905 <sup>③</sup>
1977	6,8	All	w/14-1/4" Conv.	--	6905 <sup>③</sup>
1977	6,8	All	(Exc. w/14-1/4" Conv.)	--	6905 <sup>③</sup>
<b>FORD MUSTANG</b>					
87-93	4	2.3L	Front	--	6804 <sup>③</sup>
87-93	4	2.3L		--	6904 <sup>③</sup>
87-93	4	2.3L	Main & Pre-Cat	4570 <sup>③</sup>	6904 <sup>③</sup>
84-86	4	2.3L	(Exc. Turbo)	--	6004 <sup>③</sup>
84-86	4	2.3L	Turbo	--	6905 <sup>③</sup>
1983	4	2.3L	(Exc. Turbo)	--	6904 <sup>③</sup>
1983	4	2.3L	California Emissions	--	6004 <sup>⑤</sup>
1983	4	2.3L	Turbo	--	6905 <sup>③</sup>
79-82	4	2.3L	w/o Air Tube	--	6904 <sup>③</sup>
79-82	4	2.3L	w/Air Tube	--	6005 <sup>③</sup>
99-04	6	3.8L	Front, Left	--	2554 <sup>③</sup>
99-04	6	3.8L	Rear Left	--	2505 <sup>③</sup>
99-04	6	3.8L	Complete	4566 <sup>③</sup>	--
99-04	6	3.8L	Front, Right	--	2554 <sup>③</sup>
99-04	6	3.8L	Rear Right	--	2505 <sup>③</sup>
96-98	6	3.8L		4565 <sup>③</sup>	--
94-95	6	3.8L	Left	--	2505 <sup>③</sup>
94-95	6	3.8L	Right	--	2505 <sup>③</sup>
94-95	6	3.8L	Complete	4592 <sup>③</sup>	--
84-86	6	3.8L	Rear	--	6005 <sup>③</sup>
84-86	6	3.8L	Main & Pre-Cat	--	6005 <sup>③</sup>
1983	6	3.8L		--	6005 <sup>③</sup>
1983	6	3.8L	Main & Pre-Cat	--	6004 <sup>③</sup>
2004	6	3.9L	Complete	4566 <sup>③</sup>	--
2004	6	3.9L	Front Left	--	2554 <sup>③</sup>
2004	6	3.9L	Rear Left	--	2505 <sup>③</sup>
2004	6	3.9L	Front Right	--	2554 <sup>③</sup>
2004	6	3.9L	Rear Right	--	2505 <sup>③</sup>
08-10	6	4.0L	Complete, Federal Emissions	4321 <sup>④</sup>	--
08-09	6	4.0L	Left, Federal Emissions	--	2565 <sup>④</sup>
08-09	6	4.0L	Right, Federal Emissions	--	2565 <sup>④</sup>
05-07	6	4.0L	Left	--	2565 <sup>③</sup>

③ Federal & California Emissions. Not For Sale or Use on vehicles licensed in the state of CA & NY (NY vehicles with CA Emissions). Check with your state authority for details.

④ Federal Emissions. Not For Sale or Use on vehicles licensed in the state of CA. Check with your state authority.

⑤ California Emissions. Not For Sale or Use on vehicles licensed in the state of CA & NY. Check with your state authority.

**APPLICATION LISTINGS**  
**FEDERAL CONVERTERS**



YR/YRS	CYL	LITER	DESCRIPTION	DIRECT FIT	UNIVERSAL
<b>FORD MUSTANG (Cont.)</b>					
05-07	6	4.0L	Complete	4321 ③	--
05-07	6	4.0L	Right	--	2565③
79-82	6	All	Rear	--	6904③
79-82	6	All	Main & Pre-Cat	--	6004③
1982	8	4.2L	Rear	--	6005③
1982	8	4.2L	Main & Pre-Cat	--	6004③
1981	8	4.2L	Rear	--	6005③
1981	8	4.2L	Main & Pre-Cat	--	6005③
05-07	8	4.6L	Complete	4328 ③	--
05-07	8	4.6L	Left	--	2576③○
05-07	8	4.6L	Right	--	2576③○
2004	8	4.6L	GT	5032 ③	--
99-03	8	4.6L	Complete	4322 ③	--
99-03	8	4.6L	Front, Left	--	2565③
99-03	8	4.6L	Rear Left	--	2545③
99-03	8	4.6L	Front, Right	--	2565③
99-03	8	4.6L	Rear Right	--	2545③
96-98	8	4.6L	Rear, GT Models	--	2538③
96-98	8	4.6L	Complete, (Exc. Cobra)	4966 ③	--
96-98	8	4.6L	Center, Exc. Cobra	--	2538③
96-98	8	4.6L	Front, Exc. Cobra	--	2538③
11-14	8	5.0L	From 8/16/2010, Left	5115 ③	--
11-14	8	5.0L	From 8/16/2010, Right	5116 ③	--
94-95	8	5.0L	Front Left	--	2556③
94-95	8	5.0L	Complete	4666 ③	--
94-95	8	5.0L	Front Right	--	2556③
94-95	8	5.0L	Rear Left	--	2556③
94-95	8	5.0L	Rear Right	--	2556③
86-93	8	5.0L	Front Left	--	6005③
86-93	8	5.0L	Complete	4166 ③	--
86-93	8	5.0L	Front Right	--	6005③
86-93	8	5.0L	Rear Left	--	6005③
86-93	8	5.0L	Rear Right	--	6005③
84-85	8	5.0L	Manual Trans., Rear	--	6006③
84-85	8	5.0L	Manual Trans., Main & Pre-Cat	--	6006③
84-85	8	5.0L	Auto Trans., Rear	--	6006③
84-85	8	5.0L	Auto Trans., Main & Pre-Cat	--	6006③
1983	8	5.0L	Auto Trans., Rear	--	6006③
1983	8	5.0L	Auto Trans., Main & Pre-Cat	--	6006③
1982	8	5.0L	25" Conv., Rear	--	6005③
1982	8	5.0L	25" Conv., Main & Pre-Cat	--	6004③
79-80	8	All	Rear	--	6904③
79-80	8	All	Main & Pre-Cat	--	6004③
<b>FORD MUSTANG II</b>					
75-76	4	2.3L		--	6904③
75-76	6	2.8L		--	6904R③
75-76	8	5.0L		--	6904R③

③ Federal & California Emissions. Not For Sale or Use on vehicles licensed in the state of CA & NY (NY vehicles with CA Emissions). Check with your state authority for details.  
○ EPA Enhanced OBDII By Design Unit

YR/YRS	CYL	LITER	DESCRIPTION	DIRECT FIT	UNIVERSAL
<b>FORD MUSTANG II (Cont.)</b>					
77-78	All	All	w/14" Conv.	--	6905③
77-78	All	All	w/19" Conv.	--	6905③
<b>FORD PINTO</b>					
75-80	4	All	w/14" Conv.	--	6905③
75-80	4	All	w/19" Conv.	--	6905③
75-79	4	All	(Exc. w/14" or 19" Conv.)	--	6904③
77-79	6	2.8L	w/14" Conv.	--	6905③
77-79	6	2.8L	w/19" Conv.	--	6905③
75-76	6	2.8L	Left	--	6904R③
75-76	6	2.8L	Right	--	6904R③
<b>FORD PROBE</b>					
96-97	4	2.0L	Front, Includes Head Pipe	4038 ③	--
96-97	4	2.0L		4701 ③	2539③
93-95	4	2.0L		4408 ③	6905③
89-92	4	2.2L	Auto Trans., (Exc. Turbo, Reversible/Non-Directional Unit)	4701 ③	6904③
89-92	4	2.2L	Manual Trans., (Exc. Turbo)	--	6904③
96-97	6	2.5L	Main Conv.	--	2539③
93-95	6	2.5L		4540 ③	--
90-92	6	3.0L	25-3/4" Conv.	--	6905③
<b>FORD RANCHERO</b>					
75-79	8	5.8L	Left	--	6904R③
75-79	8	5.8L	Right	--	6904R③
<b>FORD RANGER</b>					
87-88	4	2.0L	w/o Air Tube	--	6905③
86-88	4	2.0L	w/Air Tube	--	6005③
85-86	4	2.0L	To 1/86	--	6905③
07-11	4	2.3L		9255 ③	--
01-06	4	2.3L		9174 ③	--
01-06	4	2.3L	Front Universal	--	2565③
01-06	4	2.3L	Rear Universal	--	2505③
96-97	4	2.3L		4856 ③	2540③
1995	4	2.3L		4856 ③	2540③
90-94	4	2.3L		4627 ③	6905③
89-92	4	2.3L	125" W.B.	4627 ③	6905③
86-89	4	2.3L	(Exc. 125" W.B.); From 1/86	--	6005③
86-88	4	2.3L	125" W.B., (Exc. Manual Trans.); From 1/86	4627 ③	6905③
86-88	4	2.3L	Manual Trans., 125" W.B.; From 1/86	--	6005③
85-86	4	2.3L	To 1/86	--	6905③
98-01	4	2.5L		9086 ③	2514③
1983	4	All	36-1/2" Conv.	--	6005③
83-85	6	2.8L		--	6005③
88-92	6	2.9L	Front	--	2905③
88-92	6	2.9L		--	2905③
1988	6	2.9L	Complete Assembly, OEM Y-Pipe must be trimmed 1/2" from face of flange for proper insertion into converter.	9523 ③	--
86-87	6	2.9L	Rear	--	2905③
04-06	6	3.0L	Front Conv.	1105 ③	--

③ Federal & California Emissions. Not For Sale or Use on vehicles licensed in the state of CA & NY (NY vehicles with CA Emissions). Check with your state authority for details.

**APPLICATION LISTINGS**  
**FEDERAL CONVERTERS**



YR/YRS	CYL	LITER	DESCRIPTION	DIRECT FIT	UNIVERSAL
<b>FORD RANGER (Cont.)</b>					
04-06	6	3.0L	Rear Conv.	9225 ③	--
01-03	6	3.0L	Rear Conv.	9144 ③	--
01-02	6	3.0L	Complete Assembly, Front	1144 ③	--
98-00	6	3.0L	36" Conv., Front	--	2516③
98-00	6	3.0L	36" Conv., Rear	--	2516③
98-00	6	3.0L	36" Conv., Complete Assembly	9314 ③	--
98-00	6	3.0L	With 2 Converters, California Emissions, Front	4650 ⑤	--
98-00	6	3.0L	With 2 Converters, California Emissions, Front	4650 ⑤	--
96-97	6	3.0L	Front	--	2516③
96-97	6	3.0L		--	2516③
96-97	6	3.0L	Complete Assembly	4816 ③	--
91-95	6	3.0L	Front	--	2905③
91-95	6	3.0L		--	2905③
91-95	6	3.0L	Complete Assembly, OEM Y-Pipe must be trimmed 1/2" from face of flange for proper insertion into converter.	9522 ③	--
04-06	6	4.0L	Rear	9225 ③	--
2005	6	4.0L	Front, Complete Assembly, 4WD Federal Emissions	4556 ④	--
01-03	6	4.0L	Front	1044 ③	--
01-03	6	4.0L		9144 ③	--
98-00	6	4.0L	36" Conv., Front	--	2516③
98-00	6	4.0L	36" Conv., Rear	--	2516③
98-00	6	4.0L	36" Conv., Complete Assembly	9314 ③	--
96-97	6	4.0L	Front	--	2516③
96-97	6	4.0L		--	2516③
96-97	6	4.0L	Complete Assembly	4816 ③	--
90-95	6	4.0L	Front	--	2905③
90-95	6	4.0L		--	2905③
90-95	6	4.0L	Complete Assembly, OEM Y-Pipe must be trimmed 1/2" from face of flange for proper insertion into converter.	9522 ③	--
<b>FORD TAURUS</b>					
00-07	6	3.0L	Front, 12 valve	4184 ③	--
00-07	6	3.0L	Rear, 12 valve	4185 ③	--
00-05	6	3.0L	Front Y Type Conv., 24 valve Eng.	1084 ③	--
00-05	6	3.0L	Rear Manifold Conv., 24 valve Eng.	1085 ③	--
00-05	6	3.0L	Rear Main Conv., 24 valve Eng.	4185 ③	--
96-99	6	3.0L	24 valve Eng.	4052 ③	--
96-99	6	3.0L	12 Valve, California Emissions, LEV	4221 ⑤	--
96-99	6	3.0L	12 Valve, Code "U", Federal Emissions	4888 ④	--
94-95	6	3.0L	(Exc. SHO )	4663 ③	6804③
86-93	6	3.0L	w/Single Conv.	4073 ③	--
94-95	6	3.2L	SHO Models, Left	--	2538③
94-95	6	3.2L	SHO Models, Right	--	2538③
1993	6	3.2L	SHO Models, Left	--	6804③
1993	6	3.2L	SHO Models, Right	--	6804③
10-12	6	3.5L	Non-Turbo, Rear	4455 ③	--
2010	6	3.5L	Non-Turbo, Front	4454 ③	--
08-09	6	3.5L	Rear, Federal Emissions	4455 ④	--

③ Federal & California Emissions. Not For Sale or Use on vehicles licensed in the state of CA & NY (NY vehicles with CA Emissions). Check with your state authority for details.

④ Federal Emissions. Not For Sale or Use on vehicles licensed in the state of CA. Check with your state authority.

⑤ California Emissions. Not For Sale or Use on vehicles licensed in the state of CA & NY. Check with your state authority.

YR/YRS	CYL	LITER	DESCRIPTION	DIRECT FIT	UNIVERSAL
<b>FORD TAURUS (Cont.)</b>					
08-09	6	3.5L	Front, Federal Emissions	4454 ④	--
08-09	6	3.5L	FWD, Left	--	2555③
08-09	6	3.5L	Rear, California Emissions	4712 ⑤	--
08-09	6	3.5L	FWD, Right	--	2555③
91-95	6	3.8L		4118 ③	6904③
88-90	6	3.8L	Rear	--	6004③
88-90	6	3.8L	Main & Pre-Cat	--	6004③
96-99	8	3.4L	SHO Models, Front	4394 ③	--
96-99	8	3.4L	SHO Models, Rear	4395 ③	--
<b>FORD TAURUS X</b>					
08-09	6	3.5L	Rear, California Emission	4712 ⑤	--
08-09	6	3.5L	Federal Emissions, Front	4454 ④	--
08-09	6	3.5L	Federal Emissions, Rear	4455 ④	--
<b>FORD TEMPO</b>					
85-94	4	2.3L	(Exc. A.W.D.)	4122 ☆③	--
1984	4	2.3L		--	6004③
92-94	6	3.0L		4526 ③	6904③
<b>FORD THUNDERBIRD</b>					
87-88	4	2.3L		--	6906③
83-86	4	2.3L		--	6906③
80-82	6	3.3L	Rear	--	6904③
80-82	6	3.3L	Main & Pre-Cat	--	6004③
96-97	6	3.8L	Front Left	--	2554③
96-97	6	3.8L	Rear	--	2540③
96-97	6	3.8L	Complete	4858 ③	--
96-97	6	3.8L	Front Right	--	2554③
92-95	6	3.8L	w/O2 Sensor Ports, Front Left	--	6904③
92-95	6	3.8L	w/O2 Sensor Ports, Complete	4885 ③	--
92-95	6	3.8L	w/O2 Sensor Ports, Front Right	--	6904③
91-95	6	3.8L	Exc. Conv. w/O2 Sensor Ports, Front Left	--	6904③
91-95	6	3.8L	Exc. Conv. w/O2 Sensor Ports, Front Right	--	6904③
89-93	6	3.8L	Complete, Super Coupe Models	4610 ③	--
89-90	6	3.8L	Left, (Exc. Super Coupe)	--	6904③
89-90	6	3.8L	Right, (Exc. Super Coupe)	--	6904③
84-88	6	3.8L	Rear	--	6005③
84-88	6	3.8L	Main & Pre-Cat	--	6005③
82-83	6	3.8L	Rear	--	6005③
82-83	6	3.8L	Main & Pre-Cat	--	6004③
04-05	8	3.9L	Complete Assembly, 07/03 to 05	4247 ③	--
04-05	8	3.9L	Front Left, 07/03 to 05	--	2575③
04-05	8	3.9L	Front Right, 07/03 to 05	--	2575③
2003	8	3.9L	Complete Assembly	4653 ③	--
96-97	8	4.6L	Front Left	--	2554③
96-97	8	4.6L	Rear	--	2513③
96-97	8	4.6L	Complete Conv.	4152 ③	--
96-97	8	4.6L	Front Right	--	2554③
94-95	8	4.6L	w/Post Conv. O2 Sensor, Front Left	--	2504③

☆ Air Tube kit 4948 may be required for installation.

③ Federal & California Emissions. Not For Sale or Use on vehicles licensed in the state of CA & NY (NY vehicles with CA Emissions). Check with your state authority for details.

④ Federal Emissions. Not For Sale or Use on vehicles licensed in the state of CA. Check with your state authority.

⑤ California Emissions. Not For Sale or Use on vehicles licensed in the state of CA & NY. Check with your state authority.

**APPLICATION LISTINGS**  
**FEDERAL CONVERTERS**



YR/YRS	CYL	LITER	DESCRIPTION	DIRECT FIT	UNIVERSAL
<b>FORD THUNDERBIRD (Cont.)</b>					
94-95	8	4.6L	w/Post Conv. O2 Sensor, Rear	--	2513 <sup>③</sup>
94-95	8	4.6L	w/Post Conv. O2 Sensor, Complete	4593 <sup>③</sup>	--
94-95	8	4.6L	w/o Post Conv. O2 Sensor Port, Front Left	--	6904 <sup>③</sup>
94-95	8	4.6L	w/o Post Conv. O2 Sensor Port, Rear	--	2913 <sup>③</sup>
94-95	8	4.6L	w/Post Conv. O2 Sensor, Front Right	--	2504 <sup>③</sup>
94-95	8	4.6L	w/o Post Conv. O2 Sensor Port, Front Right	--	6904 <sup>③</sup>
91-93	8	5.0L	Left	--	6904 <sup>③</sup>
91-93	8	5.0L	Right	--	6904 <sup>③</sup>
91-93	8	5.0L		--	2913 <sup>③</sup>
91-93	8	5.0L	Complete System	4110 <sup>③</sup>	--
87-88	8	5.0L	w/4 Conv. System, Front Left	--	6004 <sup>③</sup>
87-88	8	5.0L	w/4 Conv. System, Front Right	--	6004 <sup>③</sup>
87-88	8	5.0L	w/4 Conv. System, Rear Left	--	6004 <sup>③</sup>
87-88	8	5.0L	w/4 Conv. System, Rear Right	--	6004 <sup>③</sup>
86-88	8	5.0L	w/3 Conv. System, Rear	--	6005 <sup>③</sup>
86-88	8	5.0L	w/3 Conv. System, Main & Pre-Cat	--	6005 <sup>③</sup>
83-85	8	5.0L	Left	--	6005 <sup>③</sup>
83-85	8	5.0L	Right	--	6005 <sup>③</sup>
77-78	8	6.6L	Left	--	9004 <sup>③</sup>
77-78	8	6.6L	Right	--	9004 <sup>③</sup>
75-76	8	7.5L	Left	--	9004 <sup>③</sup>
75-76	8	7.5L	Right	--	9004 <sup>③</sup>
80-82	8	All	Rear	--	6005 <sup>③</sup>
80-82	8	All	Main & Pre-Cat	--	6005 <sup>③</sup>
77-79	8	All	Exc. 400 C.I.D., Left	--	6904R <sup>③</sup>
77-79	8	All	Left, Exc. 6.6L 400 C.I.D.	--	6904R <sup>③</sup>
77-79	8	All	Right, Exc. 6.6L 400 C.I.D.	--	6904R <sup>③</sup>
77-79	8	All	Exc. 400 C.I.D., Right	--	6904R <sup>③</sup>
<b>FORD TORINO, GRAN TORINO</b>					
75-76	8	6.6L	Left	--	9004 <sup>③</sup>
75-76	8	6.6L	Right	--	9004 <sup>③</sup>
75-76	8	7.5L	Left	--	9004 <sup>③</sup>
75-76	8	7.5L	Right	--	9004 <sup>③</sup>
75-76	8	All	(Exc. 400 or 460 C.I.D.)	--	6904R <sup>③</sup>
<b>FORD TRANSIT CONNECT</b>					
10-13	4	2.0L	Rear	4700 <sup>③</sup>	--
10-13	4	2.0L	Front	4919 <sup>③</sup>	--
<b>FORD WINDSTAR</b>					
99-00	6	3.0L	Left	--	2566 <sup>③</sup>
99-00	6	3.0L	Right	--	2566 <sup>③</sup>
97-98	6	3.0L	Left	--	2505 <sup>③</sup>
97-98	6	3.0L	Complete Assembly	4857 <sup>③</sup>	--
97-98	6	3.0L	Right	--	2505 <sup>③</sup>
95-96	6	3.0L	Left	--	2538 <sup>③</sup>
95-96	6	3.0L	Complete Assembly	4279 <sup>③</sup>	--
95-96	6	3.0L	Right	--	2538 <sup>③</sup>
01-03	6	3.8L		4372 <sup>③</sup>	--

③ Federal & California Emissions. Not For Sale or Use on vehicles licensed in the state of CA & NY (NY vehicles with CA Emissions). Check with your state authority for details.

YR/YRS	CYL	LITER	DESCRIPTION	DIRECT FIT	UNIVERSAL
<b>FORD WINDSTAR (Cont.)</b>					
98-00	6	3.8L	(Exc. Models w/Mid-Bed O2 Sensor), Federal Emissions; From 5/98	4703 ④	--
98-00	6	3.8L	California Emissions; From 4/30/98	4055 ⑤	--
98-00	6	3.8L	California Emissions, From 04/30/98, Left	--	2566⑤
98-00	6	3.8L	California Emissions, From 04/30/98, Right	--	2566⑤
97-98	6	3.8L	Exc. Models w/Mid-Bed O2 Sensor, To 04/98, Left	--	2505③
97-98	6	3.8L	(Exc. Models w/Mid-Bed O2 Sensor), Complete Assembly; To 4/98	4702 ③	--
97-98	6	3.8L	California Emissions, To 04/29/98, Left	--	2538⑤
97-98	6	3.8L	Exc. Models w/Mid-Bed O2 Sensor, To 04/98, Right	--	2505③
97-98	6	3.8L	California Emissions, To 04/29/98, Right	--	2538⑤
95-96	6	3.8L	Left	--	2505③
95-96	6	3.8L	Complete Assembly	4551 ③	--
95-96	6	3.8L	Right	--	2505③
<b>GEO METRO</b>					
96-97	3	1.0L	w/51-1/8" Conv., Federal Emissions	4096 ④	2538④
1996	3	1.0L	w/54-1/4" Conv.	4886 ③	2504③
1995	3	1.0L	Rear, 2 Dr.	4669 ③	6904③
89-94	3	All		4170 ③	6904③
1997	4	1.3L	w/51-1/8" Conv., Federal Emissions	4096 ④	2538④
1997	4	1.3L	Front, California Emissions, Includes Pipe Between Converters	1042 ⑤	--
1997	4	1.3L	Rear, California Emissions	4342 ⑤	2504R⑤
1996	4	1.3L	w/51-1/8" Conv.	4096 ③	2538③
<b>GEO PRIZM</b>					
96-97	4	1.6L		4883 ③	2538③
90-95	4	1.6L	(Exc. H.O.)	4377 ③	6004③
90-93	4	1.6L	w/H.O.	--	6004③
96-97	4	1.8L		4883 ③	2538③
93-95	4	1.8L		4377 ③	6004③
<b>GEO SPECTRUM</b>					
1989	4	1.5L		--	6906③
1989	4	1.5L	Main & Pre-Cat	--	6004③
<b>GEO STORM</b>					
90-93	4	All		4175 ③	6906③
<b>GEO TRACKER</b>					
94-95	4	1.6L	16 valve	4790 ☆③	6904③
90-94	4	1.6L	8 valve	4467 ③	6906③
1989	4	1.6L		4467 ③	6906③
96-97	4	All		4174 ③	2504③
<b>GMC ACADIA</b>					
09-12	6	3.6L	Rear Main Conv.	4695 ③	--
07-11	6	3.6L	Front Conv.	4572 ③	--
07-11	6	3.6L	Rear Conv.	4573 ③	--
<b>GMC B7 CONVENTIONAL CHASSIS</b>					
98-00	8	7.4L		10921 ③	10907③
<b>GMC C-(2WD), K-(4WD) PICKUP 1/2 TON, (Inc. SIERRA)</b>					
09-13	6	4.3L	Complete Assembly	9273 ③①	--
			Complete Assembly	9912 ③	--
09-13	6	4.3L	Front Left	--	2566③

① Discontinued, use until inventory is depleted.

☆ Air Tube kit 4948 may be required for installation.

③ Federal & California Emissions. Not For Sale or Use on vehicles licensed in the state of CA & NY (NY vehicles with CA Emissions). Check with your state authority for details.

④ Federal Emissions. Not For Sale or Use on vehicles licensed in the state of CA. Check with your state authority.

136 ⑤ California Emissions. Not For Sale or Use on vehicles licensed in the state of CA & NY. Check with your state authority.

**APPLICATION LISTINGS**  
**FEDERAL CONVERTERS**



YR/YRS	CYL	LITER	DESCRIPTION	DIRECT FIT	UNIVERSAL
<b>GMC C-(2WD), K-(4WD) PICKUP 1/2 TON, (Inc. SIERRA) (Cont.)</b>					
09-13	6	4.3L	Rear Conv.	--	2506R <sup>③</sup>
09-13	6	4.3L	Front Right	--	2566 <sup>③</sup>
2008	6	4.3L	Exc. Classic Model, Federal Emissions	9233 <sup>④</sup>	--
00-06	6	4.3L	Dual Convs., 2000 w/Flat Spot in Middle Pipe	9083 <sup>③①</sup>	--
			Dual Convs., 2000 w/Flat Spot in Middle Pipe	9444 <sup>③</sup>	2506R <sup>③</sup>
98-00	6	4.3L	Dual Convs. 2000 w/o Flat Spot in Middle Pipe	9063 <sup>③</sup>	2516 <sup>③</sup>
96-98	6	4.3L	(Exc. Dual Conv.)	9720 <sup>③</sup>	2517 <sup>③</sup>
94-95	6	4.3L		9648 <sup>③</sup>	2907 <sup>③</sup>
1993	6	4.3L	27-1/2" Conv.	9529 <sup>③</sup>	2906 <sup>③</sup>
1993	6	4.3L	Closed Coupled Exhaust (Conv. welded to front pipe), (Exc. 27-1/2" Conv.)	--	2906 <sup>③</sup>
				--	--
88-92	6	4.3L		9529 <sup>③</sup>	2906 <sup>③</sup>
83-86	6	All		9002 <sup>③</sup>	8006 <sup>③</sup>
75-82	6	All		4001 <sup>③</sup>	6906 <sup>③</sup>
09-13	8	4.8L	Complete Assembly	9273 <sup>③①</sup>	--
09-13	8	4.8L	Front Left	--	2566 <sup>③</sup>
09-13	8	4.8L	Rear Conv.	--	2506R <sup>③</sup>
09-13	8	4.8L	Front Right	--	2566 <sup>③</sup>
09-13	8	4.8L	Complete Assembly	9912 <sup>③</sup>	--
07-08	8	4.8L	Exc. Classic Model, Federal Emissions	9233 <sup>④</sup>	--
00-06	8	4.8L	Dual Convs., 2000 w/Flat Spot in Middle Pipe	9083 <sup>③①</sup>	--
			Dual Convs., 2000 w/Flat Spot in Middle Pipe	9444 <sup>③</sup>	2506R <sup>③</sup>
99-00	8	4.8L	Dual Convs. 2000 w/o Flat Spot in Middle Pipe	9063 <sup>③</sup>	2516 <sup>③</sup>
96-98	8	5.0L	Single Conv.	9720 <sup>③</sup>	2517 <sup>③</sup>
94-95	8	5.0L		9648 <sup>③</sup>	2907 <sup>③</sup>
1993	8	5.0L	27-1/2" Conv.	9529 <sup>③</sup>	2906 <sup>③</sup>
1993	8	5.0L	(Exc. 27-1/2" Conv.)	--	2906 <sup>③</sup>
88-92	8	5.0L		9529 <sup>③</sup>	2906 <sup>③</sup>
83-86	8	5.0L		4001 <sup>③</sup>	6906 <sup>③</sup>
09-13	8	5.3L	Complete Assembly	9273 <sup>③①</sup>	--
09-13	8	5.3L	Front Left	--	2566 <sup>③</sup>
09-13	8	5.3L	Rear Conv.	--	2506R <sup>③</sup>
09-13	8	5.3L	Front Right	--	2566 <sup>③</sup>
09-13	8	5.3L	Complete Assembly	9912 <sup>③</sup>	--
07-08	8	5.3L	Exc. Classic Model, Federal Emissions	9233 <sup>④</sup>	--
00-06	8	5.3L	Dual Convs., 2000 w/Flat Spot in Middle Pipe	9083 <sup>③①</sup>	--
			Dual Convs., 2000 w/Flat Spot in Middle Pipe	9444 <sup>③</sup>	2506R <sup>③</sup>
99-00	8	5.3L	Dual Convs. 2000 w/o Flat Spot in Middle Pipe	9063 <sup>③</sup>	2516 <sup>③</sup>
96-98	8	5.7L	Single Conv.	9720 <sup>③</sup>	2517 <sup>③</sup>
96-98	8	5.7L	Dual Convs.	9333 <sup>③</sup>	2540 <sup>③</sup>
94-95	8	5.7L		9648 <sup>③</sup>	2907 <sup>③</sup>
1993	8	5.7L	(Exc. 26-1/4" Conv.)	--	2907 <sup>③</sup>
92-93	8	5.7L	26-1/4" Conv.	9184 <sup>③</sup>	2907 <sup>③</sup>
88-91	8	5.7L		9184 <sup>③</sup>	2907 <sup>③</sup>
83-86	8	5.7L		9002 <sup>③</sup>	2906 <sup>③</sup>
07-08	8	6.0L	Exc. Classic Model, Federal Emissions	9233 <sup>④</sup>	--
06-08	8	6.0L	Left	--	2587 <sup>③①</sup>

- ① Discontinued, use until inventory is depleted.
- ③ Federal & California Emissions. Not For Sale or Use on vehicles licensed in the state of CA & NY (NY vehicles with CA Emissions). Check with your state authority for details.
- ④ Federal Emissions. Not For Sale or Use on vehicles licensed in the state of CA. Check with your state authority.
- EPA Enhanced OBDII By Design Unit



YR/YRS	CYL	LITER	DESCRIPTION	DIRECT FIT	UNIVERSAL
<b>GMC C-(2WD), K-(4WD) PICKUP 1/2 TON, (Inc. SIERRA) (Cont.)</b>					
06-08	8	6.0L	Right	--	2587③○
02-06	8	6.0L	1500 HD, Federal Emissions, Left	9223 ④	--
02-06	8	6.0L	1500 HD, Federal Emissions, Right	9222 ④	--
09-10	8	6.2L		9642 ③	--
75-79	8	7.4L		9002 ③	8006③
75-82	8	All	(Exc. 454 C.I.D.)	4001 ③	6906③
<b>GMC C-(2WD), K-(4WD) PICKUP 3/4 TON, (Inc. SIERRA)</b>					
75-84	6	4.1L		9002 ③	9006③
94-95	6	4.3L	To 8600 lbs GVW	9648 ③	2907③
91-93	6	4.3L	To 8600 lbs GVW, w/3" Piping	9184 ③	2907③
88-93	6	4.3L	To 8600 lbs GVW, w/2-1/2" Piping	9529 ③	2906③
85-86	6	4.3L	C2500	9002 ③	2906③
96-98	8	5.0L		9720 ③	2517③
94-95	8	5.0L	To 8600 lbs GVW	9648 ③	2907③
88-93	8	5.0L		9529 ③	2906③
83-86	8	5.0L		9002 ③	2906③
2000	8	5.3L	Dual Convs., 2000 w/Flat Spot in Middle Pipe	9083 ③○	--
			Dual Convs., 2000 w/Flat Spot in Middle Pipe	9444 ③	2506R③
99-00	8	5.3L	Dual Convs. 2000 w/o Flat Spot in Middle Pipe	9063 ③	2516③
96-00	8	5.7L	8600 lbs GVW and Over, Front	9092 ③	2517③
96-00	8	5.7L	8600 lbs GVW and Over, 155.5" W.B., Rear	9293 ②③	2517③
96-99	8	5.7L	8600 lbs GVW and Over, 141.5" W.B., Rear	9093 ③	2517③
96-99	8	5.7L	8600 lbs GVW and Over, 131.5" W.B., Rear	9192 ③	2517③
96-98	8	5.7L	Dual Convs., to 8600 lbs GVW	9333 ③	2540③
94-95	8	5.7L	To 8600 lbs GVW	9648 ③	2907③
88-93	8	5.7L	To 8600 lbs GVW	9184 ③	8007③
88-93	8	5.7L	Models w/Rear Conv. behind muffler, to 8600 lbs GVW	9186 ③	8007③
88-93	8	5.7L	To 11000 lbs GVW	10903 ③	10907③
88-93	8	5.7L	Models w/Rear Conv. behind muffler, to 11000 lbs GVW	--	10907③
83-86	8	5.7L		9002 ③	2906③
11-13	8	6.0L	2500 HD, w/o Third Converter	9545 ③	--
07-09	8	6.0L	2500 HD	9873 ③	--
06-08	8	6.0L	Left	--	2587③○
06-08	8	6.0L	Right	--	2587③○
03-06	8	6.0L	2500 HD, California Emissions, Right	9878 ⑤	--
03-06	8	6.0L	2500 HD, California Emissions, Left	9877 ⑤	--
01-06	8	6.0L	2500 HD, 133" WB, Federal Emissions, Right Side, OE System is completely welded. Additional sizing, bushings, cutting may be required.	9990 ④	--
				--	--
				--	--
01-06	8	6.0L	2500 HD, 133" WB, Federal Emissions, Left Side, OE System is completely welded. Additional sizing, bushings, cutting may be required.	9223 ④	--
				--	--
				--	--
01-06	8	6.0L	2500 HD, 143.5", 153", 157.5", 167" WB, Federal Emissions, Right Side, OE System is completely welded. Additional sizing, bushings, cutting may be required.	9222 ④	--
				--	--
				--	--

- ① Discontinued, use until inventory is depleted.
- ② When using with aftermarket piping, direct fit converter may require INLET/OUTLET pipe resizing.
- ③ Federal & California Emissions. Not For Sale or Use on vehicles licensed in the state of CA & NY (NY vehicles with CA Emissions). Check with your state authority for details.
- ④ Federal Emissions. Not For Sale or Use on vehicles licensed in the state of CA. Check with your state authority.
- ⑤ California Emissions. Not For Sale or Use on vehicles licensed in the state of CA & NY. Check with your state authority.
- EPA Enhanced OBDII By Design Unit

**APPLICATION LISTINGS  
FEDERAL CONVERTERS**



YR/YRS	CYL	LITER	DESCRIPTION	DIRECT FIT	UNIVERSAL
<b>GMC C-(2WD), K-(4WD) PICKUP 3/4 TON, (Inc. SIERRA) (Cont.)</b>					
01-06	8	6.0L	2500 HD, 143.5", 153", 157.5", 167" WB, Federal Emissions, Left Side, OE System is completely welded. Additional sizing, bushings, cutting may be required.	9223 ④ -- --	-- -- --
01-03	8	6.0L	Federal Emissions	--	10907④
01-03	8	6.0L	California Emissions, Left	--	8007⑤
01-03	8	6.0L	California Emissions, Right	--	8007⑤
01-02	8	6.0L	2500 HD, Incomplete Chassis, Right	9276 ③	--
01-02	8	6.0L	2500 HD, Incomplete Chassis, Left	9277 ③	--
2001	8	6.0L	143.5" W.B., Federal Emissions, Right, O.E. System is Completely Welded, Replace With Complete AP System	9980 ④ --	-- --
2001	8	6.0L	Federal Emissions, Left, O.E. System is completely welded, Replace with complete AP system	9213 ④ --	-- --
99-00	8	6.0L	Right, 6-1/2' Bed	9212 ③	--
99-00	8	6.0L	Left	9213 ③	--
99-00	8	6.0L	143.5" W.B., Right, O.E. System is Completely Welded, Replace With Complete Ap System	9980 ③ --	-- --
96-00	8	7.4L	Front, Federal Emissions	9703 ④	8006④
91-95	8	7.4L	To 8600 lbs GVW	9184 ③	8007③
91-95	8	7.4L	Models w/Rear Conv. behind muffler, to 8600 lbs GVW	9186 ③	8007③
91-95	8	7.4L	To 11000 lbs GVW	10903 ③	10907③
91-95	8	7.4L	Models w/Rear Conv. behind muffler, to 11000 lbs GVW	--	10907③
06-07	8	8.1L	Left	--	2587③○
06-07	8	8.1L	Right	--	2587③○
03-06	8	8.1L	2500 HD, California Emissions, Right	9878 ⑤	--
01-06	8	8.1L	2500 HD, 133" WB, Federal Emissions, Right Side, OE System is completely welded. Additional sizing, bushings, cutting may be required.	9990 ④ -- --	-- -- --
01-06	8	8.1L	2500 HD, 133" WB, Federal Emissions, Left Side, OE System is completely welded. Additional sizing, bushings, cutting may be required.	9223 ④ -- --	-- -- --
01-06	8	8.1L	2500 HD, 143.5", 153", 157.5", 167" WB, Federal Emissions, Right Side, OE System is completely welded. Additional sizing, bushings, cutting may be required.	9222 ④ -- --	-- -- --
01-06	8	8.1L	2500 HD, 143.5", 153", 157.5", 167" WB, Federal Emissions, Left Side, OE System is completely welded. Additional sizing, bushings, cutting may be required.	9223 ④ -- --	-- -- --
2001	8	8.1L	California Emissions, Left	--	8007⑤
2001	8	8.1L	California Emissions, Right	--	8007⑤
75-82	8	All		9002 ③	9006③
<b>GMC C-(2WD), K-(4WD) PICKUP 1 TON, (Inc. SIERRA)</b>					
96-00	8	5.7L	8600 lbs GVW and Over, Front	9092 ③	2517③
96-00	8	5.7L	8600 lbs GVW and Over, 155.5" W.B., Rear	9293 ②③	2517③
96-99	8	5.7L	8600 lbs GVW and Over, 141.5" W.B., Rear	9093 ③	2517③
96-99	8	5.7L	8600 lbs GVW and Over, 131.5" W.B., Rear	9192 ③	2517③
96-97	8	5.7L	Rear	--	2516③
96-97	8	5.7L	Front	--	2516③
1986	8	5.7L	To 9000 lbs GVW	9529 ③	8006③

- ② When using with aftermarket piping, direct fit converter may require INLET/OUTLET pipe resizing.
- ③ Federal & California Emissions. Not For Sale or Use on vehicles licensed in the state of CA & NY (NY vehicles with CA Emissions). Check with your state authority for details.
- ④ Federal Emissions. Not For Sale or Use on vehicles licensed in the state of CA. Check with your state authority.
- ⑤ California Emissions. Not For Sale or Use on vehicles licensed in the state of CA & NY. Check with your state authority.
- EPA Enhanced OBDII By Design Unit

YR/YRS	CYL	LITER	DESCRIPTION	DIRECT FIT	UNIVERSAL
<b>GMC C-(2WD), K-(4WD) PICKUP 1 TON, (Inc. SIERRA) (Cont.)</b>					
11-13	8	6.0L	3500 HD, w/o Third Converter	9545 ③	--
07-09	8	6.0L	3500 HD	9873 ③	--
06-08	8	6.0L	Left	--	2587③○
06-08	8	6.0L	Right	--	2587③○
03-06	8	6.0L	California Emissions, Right	9878 ⑤	--
03-06	8	6.0L	California Emissions, Left	9877 ⑤	--
01-02	8	6.0L	Federal Emissions	--	10907④
01-02	8	6.0L	California Emissions, Left	--	8007⑤
01-02	8	6.0L	California Emissions, Right	--	8007⑤
96-00	8	7.4L	Front, Federal Emissions	9703 ④	8006④
96-00	8	7.4L	Rear, Federal Emissions	--	8006④
96-00	8	7.4L	159.5" W.B., 15000 lbs GVW, Rear	9543 ③	--
06-07	8	8.1L	Left	--	2587③○
06-07	8	8.1L	Right	--	2587③○
03-06	8	8.1L	California Emissions, Right	9878 ⑤	--
03-06	8	8.1L	California Emissions, Left	9877 ⑤	--
2001	8	8.1L	California Emissions, Left	--	8007⑤
2001	8	8.1L	California Emissions, Right	--	8007⑤
93-95	8	All	To 12000 lbs GVW	10903 ③	10907③
93-95	8	All	Models w/Rear Conv. behind muffler, To 12000 lbs GVW	--	10907③
93-95	8	All	To 9000 lbs GVW	9184 ③	8007③
93-95	8	All	Models w/Rear Conv., To 9000 lbs GVW	9186 ③	8007③
88-92	8	All	To 12000 lbs GVW	10903 ③	10907③
88-92	8	All	Models w/Rear Conv. behind muffler, To 12000 lbs GVW	--	10907③
88-92	8	All	To 9000 lbs GVW	9184 ③	8007③
88-92	8	All	Models w/Rear Conv., To 9000 lbs GVW	9186 ③	8007③
<b>GMC C4500 TOPKICK</b>					
03-09	8	8.1L	Front	9869 ③	--
03-09	8	8.1L	Rear	9870 ③	--
<b>GMC C5500</b>					
05-08	8	8.1L	Front	9194 ③	2517③
05-08	8	8.1L		9195 ③	2517③
<b>GMC CABALLERO/SPRINT</b>					
1984	6	3.8L	231 C.I.D.	4112 ☆③	6005③
83-84	6	3.8L	229 C.I.D.	4115 ☆③	6005③
81-83	6	3.8L	231 C.I.D.	4111 ☆③	6005③
81-82	6	3.8L	229 C.I.D.	4111 ☆③	6005③
1980	6	3.8L	229 C.I.D., Angled Conv.	4111 ☆③	6005③
1980	6	3.8L	229 C.I.D., Straight Conv.	4019 ③	6905③
1980	6	3.8L	231 C.I.D.	--	6006③
75-77	6	4.1L		--	6906③
85-87	6	4.3L		4303 ☆③	6005③
78-79	6	All		4111 ☆③	6005③
1979	8	4.4L	267 C.I.D.	4111 ☆③	6005③
1979	8	5.0L		--	6906③
1978	8	5.0L		4111 ☆③	6005③
76-77	8	5.0L		--	6906③

☆ Air Tube kit 4948 may be required for installation.

③ Federal & California Emissions. Not For Sale or Use on vehicles licensed in the state of CA & NY (NY vehicles with CA Emissions). Check with your state authority for details.

④ Federal Emissions. Not For Sale or Use on vehicles licensed in the state of CA. Check with your state authority.

⑤ California Emissions. Not For Sale or Use on vehicles licensed in the state of CA & NY. Check with your state authority.

**APPLICATION LISTINGS**  
**FEDERAL CONVERTERS**



YR/YRS	CYL	LITER	DESCRIPTION	DIRECT FIT	UNIVERSAL
<b>GMC CABALLERO/SPRINT (Cont.)</b>					
78-79	8	5.7L		--	6906 <sup>③</sup>
75-77	8	5.7L		--	6906 <sup>③</sup>
75-76	8	6.6L		--	8006 <sup>③</sup>
1975	8	7.4L		--	8006 <sup>③</sup>
83-87	8	All		4115 ☆ <sup>③</sup>	6005 <sup>③</sup>
81-82	8	All		4111 ☆ <sup>③</sup>	6005 <sup>③</sup>
1980	8	All		--	6006 <sup>③</sup>
<b>GMC CANYON</b>					
04-06	4	2.8L	Front	1216 <sup>③</sup>	--
04-06	4	2.8L		9216 <sup>③</sup>	2575R <sup>③</sup>
07-12	4	2.9L	Front Main Conv.	1227 <sup>③</sup>	--
04-06	5	3.5L	Front	4487 <sup>③</sup>	--
04-06	5	3.5L		9216 <sup>③</sup>	2575R <sup>③</sup>
07-12	5	3.7L	Manifold Unit, Front	1226 <sup>③</sup>	--
09-12	8	5.3L	Left	9549 <sup>③</sup>	--
09-12	8	5.3L	Right	9550 <sup>③</sup>	--
<b>GMC ENVOY</b>					
08-09	6	4.2L		9546 <sup>③</sup>	--
06-07	6	4.2L	Exc. XL	9171 <sup>③</sup>	2506 <sup>③</sup>
02-05	6	4.2L	Exc. XL	9154 <sup>③</sup>	2506R <sup>③</sup>
2000	6	4.3L	4WD & Auto Trans. & 4 Dr., Federal Emissions	9108 <sup>④</sup>	2517 <sup>④</sup>
06-09	8	5.3L		9544 <sup>③</sup>	--
05-06	8	5.3L		9412 <sup>③</sup>	2566 <sup>③</sup>
<b>GMC ENVOY XL</b>					
02-05	6	4.2L		9254 <sup>③①</sup>	--
				9998 <sup>③</sup>	2506R <sup>③</sup>
05-06	8	5.3L	Center	9871 <sup>③</sup>	--
03-04	8	5.3L		9879 <sup>③</sup>	--
<b>GMC ENVOY XUV</b>					
04-05	6	4.2L		9254 <sup>③①</sup>	--
				9998 <sup>③</sup>	2506R <sup>③</sup>
2005	8	5.3L	Center	9871 <sup>③</sup>	--
<b>GMC G -VAN 1/2 &amp; 3/4 TON (Inc. Savana Van)</b>					
83-84	6	4.1L		4001 <sup>③</sup>	6906 <sup>③</sup>
75-82	6	4.1L		9002 <sup>③</sup>	2906 <sup>③</sup>
09-14	6	4.3L	1500	9872 <sup>③</sup>	--
07-08	6	4.3L	1500, Right	--	2565R <sup>③</sup>
07-08	6	4.3L	1500, Left	--	2565R <sup>③</sup>
03-06	6	4.3L	1500, Complete Assembly	9991 <sup>③</sup>	2576R <sup>③</sup>
03-05	6	4.3L	2500, Complete Assembly	9991 <sup>③</sup>	2576R <sup>③</sup>
00-02	6	4.3L	Under 8500 lbs GVW	9019 <sup>③</sup>	2517 <sup>③</sup>
96-99	6	4.3L	Over 8500 lbs GVW, w/3 Bolt Outlet Flange	9138 <sup>③</sup>	2517 <sup>③</sup>
96-99	6	4.3L	To 8500 lbs GVW, w/3 Bolt Outlet Flange	9649 <sup>③</sup>	2517 <sup>③</sup>
1995	6	4.3L		9616 <sup>③</sup>	2907 <sup>③</sup>
85-94	6	4.3L		9002 <sup>③</sup>	2906 <sup>③</sup>
08-13	8	4.8L	2500, Cutaway & Stripped Chassis, Left	9876 <sup>③</sup>	--
10-11	8	4.8L	2500, Y-Pipe Unit, Exc. Cutaway & Stripped Chassis	9872 <sup>③</sup>	--

① Discontinued, use until inventory is depleted.

☆ Air Tube kit 4948 may be required for installation.

③ Federal & California Emissions. Not For Sale or Use on vehicles licensed in the state of CA & NY (NY vehicles with CA Emissions). Check with your state authority for details.

④ Federal Emissions. Not For Sale or Use on vehicles licensed in the state of CA. Check with your state authority.

YR/YRS	CYL	LITER	DESCRIPTION	DIRECT FIT	UNIVERSAL
<b>GMC G -VAN 1/2 &amp; 3/4 TON (Inc. Savana Van) (Cont.)</b>					
06-10	8	4.8L	2500, Standard Passenger Van, Standard Cargo Van, Extended Cargo Van, California Emissions, Left	9874 ⑤ --	-- --
06-10	8	4.8L	2500, Standard Passenger Van, Standard Cargo Van, Extended Cargo Van, California Emissions, Right	9875 ⑤ --	-- --
06-09	8	4.8L	2500, Left, Federal Emissions, Body to Front	9995 ④	2577④
06-09	8	4.8L	2500, Right, Federal Emissions, Body to Front	9994 ④	2577④
03-05	8	4.8L	2500, Right Conv. 68-1/4", Federal Emissions	9208 ④	2517④
03-05	8	4.8L	2500, Right Conv. 60-3/4", Federal Emissions	9188 ④	2517④
03-05	8	4.8L	2500, Left, Federal Emissions	9189 ④	2517④
03-05	8	4.8L	2500, 2 Bodies, Left, California Emissions	9992 ⑤	--
03-05	8	4.8L	2500, 2 Bodies, Right, California Emissions	9993 ⑤	--
00-02	8	5.0L	Under 8500 lbs GVW	9019 ③	2517③
00-01	8	5.0L	G20 Model	--	2517③
96-99	8	5.0L	w/3 Bolt Outlet Flange	9649 ③	2517③
1995	8	5.0L	(Exc. 146" W.B.)	9616 ③	2907③
87-94	8	5.0L		9002 ③	2906③
09-14	8	5.3L	1500	9872 ③	--
03-05	8	5.3L	1500 & 2500, Complete Assembly	9991 ③	2576R③
2002	8	5.7L	1500, Under 8500 lbs GVW, Complete Assembly	9278 ③	--
2002	8	5.7L	1500, Under 8500 lbs GVW, Left	--	2505R③
2002	8	5.7L	1500, Under 8500 lbs GVW, Right	--	2505R③
01-02	8	5.7L	1500 & 2500, Over 8500 lbs GVW, Left	9916 ③	--
01-02	8	5.7L	1500 & 2500, Over 8500 lbs GVW, Right	9917 ③	--
00-02	8	5.7L	2500, Under 8500 lbs GVW	9880 ③	--
2000	8	5.7L	2500, Under 8500 lbs GVW, Left	--	2517③
2000	8	5.7L	2500, Under 8500 lbs GVW, Right	--	2517③
2000	8	5.7L	1500, Under 8500 lbs GVW	9880 ③	--
97-00	8	5.7L	2500 Over 8500 lbs GVW, Right	9080 ③	2517③
97-00	8	5.7L	2500 Over 8500 lbs GVW, Left	9081 ③	2517③
96-99	8	5.7L	Single Conv. System, w/3 Bolt Outlet Flange	9649 ③	2517③
96-99	8	5.7L	Dual Conv. System, Under 8500 lbs GVW, Right	9042 ③	2517③
96-99	8	5.7L	Dual Conv. System, Under 8500 lbs GVW, Left	9043 ③	2517③
1995	8	5.7L	(Exc. 146" W.B.)	9616 ③	2907③
92-94	8	5.7L	Over 9000 lbs GVW	10903 ③	10907③
92-94	8	5.7L	Models w/Rear Conv. behind muffler, Over 9000 lbs GVW	--	10907③
92-94	8	5.7L	To 9000 lbs GVW	9184 ③	8007③
92-94	8	5.7L	Models w/Rear Conv. behind muffler, To 9000 lbs GVW	9186 ③	8007③
87-91	8	5.7L	Over 9000 lbs GVW	10903 ③	10907③
87-91	8	5.7L	Models w/Rear Conv. behind muffler, Over 9000 lbs GVW	--	10907③
87-91	8	5.7L	To 9000 lbs GVW	9184 ③	8007③
87-91	8	5.7L	Models w/Rear Conv., To 9000 lbs GVW	9186 ③	8007③
75-76	8	5.7L	w/Conv.	4001 ③	6906③
08-13	8	6.0L	2500, Cutaway & Stripped Chassis, Left	9876 ③	--
11-12	8	6.0L	2500, Complete Assembly	9279 ③	--
10-11	8	6.0L	2500, Y-Pipe Unit, Exc. Cutaway & Stripped Chassis	9872 ③	--
06-10	8	6.0L	2500, Standard Passenger Van, Standard Cargo Van, Extended Cargo Van, California Emissions, Left	9874 ⑤ --	-- --

③ Federal & California Emissions. Not For Sale or Use on vehicles licensed in the state of CA & NY (NY vehicles with CA Emissions). Check with your state authority for details.

④ Federal Emissions. Not For Sale or Use on vehicles licensed in the state of CA. Check with your state authority.

⑤ California Emissions. Not For Sale or Use on vehicles licensed in the state of CA & NY. Check with your state authority.

**APPLICATION LISTINGS**  
**FEDERAL CONVERTERS**



YR/YRS	CYL	LITER	DESCRIPTION	DIRECT FIT	UNIVERSAL
<b>GMC G -VAN 1/2 &amp; 3/4 TON (Inc. Savana Van) (Cont.)</b>					
06-10	8	6.0L	2500, Standard Passenger Van, Standard Cargo Van, Extended Cargo Van, California Emissions, Right	9875 ⑤ --	-- --
06-09	8	6.0L	2500, Left, Federal Emissions, Body to Front	9995 ④	2577④
06-09	8	6.0L	2500, Right, Federal Emissions, Body to Front	9994 ④	2577④
03-05	8	6.0L	2500, Right Conv. 68-1/4", Federal Emissions	9208 ④	2517④
03-05	8	6.0L	2500, Right Conv. 60-3/4", Federal Emissions	9188 ④	2517④
03-05	8	6.0L	2500, Left, Federal Emissions	9189 ④	2517④
03-05	8	6.0L	2500, 2 Bodies, Left, California Emissions	9992 ⑤	--
03-05	8	6.0L	2500, 2 Bodies, Right, California Emissions	9993 ⑤	--
79-80	8	6.6L		9002 ③	8006③
1995	8	All	146" W.B.	--	2907③
83-86	8	All		9002 ③	8006③
79-82	8	All	(Exc. 400 C.I.D.)	4001 ③	6906③
<b>GMC G -VAN 1 TON (Inc. Savana Van)</b>					
1995	6	4.3L		--	2907③
91-94	6	4.3L	Over 8500 lbs GVW	--	10906③
91-94	6	4.3L	To 8500 lbs GVW	9002 ③	2906③
78-90	6	All	To 8500 lbs GVW	9002 ③	8006③
08-13	8	4.8L	Cutaway & Stripped Chassis, Left	9876 ③	--
10-11	8	4.8L	Y-Pipe Unit, Exc. Cutaway & Stripped Chassis	9872 ③	--
06-10	8	4.8L	Standard Passenger Van, Standard Cargo Van, Extended Cargo Van, California Emissions, Left	9874 ⑤ --	-- --
06-10	8	4.8L	Standard Passenger Van, Standard Cargo Van, Extended Cargo Van, California Emissions, Right	9875 ⑤ --	-- --
01-02	8	5.7L	Over 8500 lbs GVW, Left	9916 ③	--
01-02	8	5.7L	Over 8500 lbs GVW, Right	9917 ③	--
00-02	8	5.7L	Under 8500 lbs GVW	9880 ③	--
2000	8	5.7L		--	2517③
97-00	8	5.7L	135" & 155" W.B. Over 8500 lbs GVW, Right	9080 ③	2517③
97-00	8	5.7L	135" & 155" W.B. Over 8500 lbs GVW, Left	9081 ③	2517③
1996	8	5.7L	Under 8500 lbs GVW, Right	9042 ③	2517③
1996	8	5.7L	Under 8500 lbs GVW, Left	9043 ③	2517③
1996	8	5.7L	135" & 155" W.B. Over 8500 lbs GVW, Right	9080 ③	2517③
1996	8	5.7L	135" & 155" W.B. Over 8500 lbs GVW, Left	9081 ③	2517③
1995	8	5.7L	Under 9000 lbs GVW	--	8007③
87-91	8	5.7L	Over 9000 lbs GVW	10903 ③	10907③
87-91	8	5.7L	Models w/Rear Conv. behind muffler, Over 9000 lbs GVW	--	10907③
87-91	8	5.7L	Under 9000 lbs GVW	9184 ③	8007③
87-91	8	5.7L	Models w/Rear Conv. behind muffler, Under 9000 lbs GVW	9186 ③	8007③
80-86	8	5.7L		9002 ③	8006③
08-13	8	6.0L	Cutaway & Stripped Chassis, Left	9876 ③	--
11-12	8	6.0L	135" and 155" W.B., Complete Assembly	9279 ③	--
10-11	8	6.0L	Y-Pipe Unit, Exc. Cutaway & Stripped Chassis	9872 ③	--
06-10	8	6.0L	Standard Passenger Van, Standard Cargo Van, Extended Passenger Van, Extended Cargo Van, California Emissions, Left	9874 ⑤ --	-- --
06-10	8	6.0L	Standard Passenger Van, Standard Cargo Van, Extended Passenger Van, Extended Cargo Van, California Emissions, Right	9875 ⑤ --	-- --

③ Federal & California Emissions. Not For Sale or Use on vehicles licensed in the state of CA & NY (NY vehicles with CA Emissions). Check with your state authority for details.

④ Federal Emissions. Not For Sale or Use on vehicles licensed in the state of CA. Check with your state authority.

⑤ California Emissions. Not For Sale or Use on vehicles licensed in the state of CA & NY. Check with your state authority.

YR/YRS	CYL	LITER	DESCRIPTION	DIRECT FIT	UNIVERSAL
<b>GMC G -VAN 1 TON (Inc. Savana Van) (Cont.)</b>					
06-09	8	6.0L	Left, Federal Emissions, Body to Front	9995 ④	2577④
06-09	8	6.0L	Right, Federal Emissions, Body to Front	9994 ④	2577④
03-05	8	6.0L	Right, 68-1/4", Federal Emissions	9208 ④	2517④
03-05	8	6.0L	Right, 60-3/4", Federal Emissions	9188 ④	2517④
03-05	8	6.0L	Left, Federal Emissions	9189 ④	2517④
03-05	8	6.0L	2 Bodies, Left, California Emissions	9992 ⑤	--
03-05	8	6.0L	2 Bodies, Right, California Emissions	9993 ⑤	--
1995	8	7.4L	Under 9000 lbs GVW	--	8007③
92-94	8	All	Over 9000 lbs GVW	10903 ③	10907③
92-94	8	All	Under 9000 lbs GVW	9184 ③	8007③
78-79	8	All	w/Conv.	9002 ③	8006③
<b>GMC JIMMY FULL SIZE</b>					
75-82	6	4.1L		4001 ③	6906③
87-91	8	5.7L		9184 ③	2907③
75-78	8	6.6L		9002 ③	8006③
83-87	8	All	(Exc. 1987, 350 C.I.D., 5.7L)	9002 ③	2906③
75-82	8	All	(Exc. 400 C.I.D.)	4001 ③	6906③
<b>GMC S-15 JIMMY</b>					
83-88	4	All		4019 ③	6905③
83-87	6	2.8L		4019 ③	6905③
01-02	6	4.3L	Complete Assembly, 4WD, 2 Dr. California Emissions, Auto Trans.	9210 ⑤	--
01-02	6	4.3L	Rear, 4WD, 2 Dr., California Emissions	--	2516⑤
01-02	6	4.3L	Complete Assembly, 2WD, 2 Dr., California Emissions, Auto Trans.	9209 ⑤	--
01-02	6	4.3L	Rear, 2WD, 2 Dr., California Emissions	--	2564R⑤
01-02	6	4.3L	2 Dr., Federal Emissions	--	2517④
00-02	6	4.3L	4WD & Auto Trans. & 4 Dr., California Emissions	9109 ⑤	--
00-02	6	4.3L	Complete Assembly, 2WD, 4 Dr., California Emissions	9214 ⑤	--
00-02	6	4.3L	Front, 4WD & Auto Trans. & 4 Dr., California Emissions	--	2576R⑤
00-02	6	4.3L	Rear, 4WD & Auto Trans. & 4 Dr., California Emissions	--	2517⑤
2000	6	4.3L	4WD & Auto Trans. & 4 Dr., Federal Emissions	9108 ④	2517④
2000	6	4.3L	Complete Assembly, 2WD, 4 Dr., Federal Emissions	9215 ④	--
2000	6	4.3L	2WD, 2 Dr., Federal Emissions	9229 ④	2517④
2000	6	4.3L	4WD, 2 Dr., Federal Emissions	9230 ④	2516④
98-99	6	4.3L	Front, California Emissions	1192 ⑤	2538⑤
98-99	6	4.3L	Rear, California Emissions	4792 ⑤	2516⑤
98-99	6	4.3L	Federal Emissions	4792 ④	2516④
96-97	6	4.3L		4792 ③	2516③
1995	6	4.3L	4WD, 4 Door	4482 ③	2516③
1995	6	4.3L	4WD, 2 Door	4682 ③	2516③
92-94	6	4.3L	Code "Z" Eng.	4088 ③	2906③
92-94	6	4.3L	Code "W" Eng.	4880 ③	2906③
88-91	6	All		4088 ③	2906③
<b>GMC S-Series (2WD), T-Series (4WD) PICKUP (SONOMA)</b>					
82-84	4	1.9L		4019 ③	6905③
83-84	4	2.0L		4019 ③	6905③
96-03	4	2.2L		4819 ③	2506③
94-95	4	2.2L		4623 ③	6905③

③ Federal & California Emissions. Not For Sale or Use on vehicles licensed in the state of CA & NY (NY vehicles with CA Emissions). Check with your state authority for details.

④ Federal Emissions. Not For Sale or Use on vehicles licensed in the state of CA. Check with your state authority.

⑤ California Emissions. Not For Sale or Use on vehicles licensed in the state of CA & NY. Check with your state authority.

**APPLICATION LISTINGS  
FEDERAL CONVERTERS**



YR/YRS	CYL	LITER	DESCRIPTION	DIRECT FIT	UNIVERSAL
<b>GMC S-Series (2WD), T-Series (4WD) PICKUP (SONOMA) (Cont.)</b>					
85-93	4	2.5L		4019 ③	6905③
88-93	6	2.8L		4088 ③	6906③
82-87	6	2.8L		4019 ③	6905③
01-04	6	4.3L	4WD, 4 Dr., California Emissions	9109 ⑤	--
01-04	6	4.3L	Front, 4WD, 4 Dr., California Emissions	--	2576R⑤
01-04	6	4.3L	Rear, 4WD, 4 Dr., California Emissions	--	2517⑤
01-03	6	4.3L	Extended Cab, 4WD, California Emissions	9110 ⑤	--
00-02	6	4.3L	2WD & Auto Trans., Calif. Emissions	9091 ⑤	--
2000	6	4.3L	2WD	--	2516③
2000	6	4.3L	4WD, Federal Emissions	9227 ④	--
2000	6	4.3L	2WD, Extended Cab, Auto. Trans., Federal Emissions	9228 ④	--
98-99	6	4.3L	2WD & Extended Cab, California Emissions	1177 ⑤	2564R⑤
98-99	6	4.3L	2WD, w/ 31 1/2" OAL Conv.	4977 ③	2516③
96-99	6	4.3L	4WD	9881 ③	2517③
96-97	6	4.3L	2WD	9710 ③	2516③
1995	6	4.3L	4WD & Extended Cab	9708 ③	2516③
1995	6	4.3L	2WD	4628 ③	2516③
88-94	6	4.3L		4088 ③	6906③
<b>GMC SAFARI VAN</b>					
88-90	4	2.5L		--	6905③
85-87	4	2.5L		--	6905③
00-05	6	4.3L	California Emissions	9148 ⑤	--
00-01	6	4.3L	Federal Emissions	9132 ④	2517④
96-99	6	4.3L		9075 ③	2517③
94-95	6	4.3L	(Exc. AWD)	9594 ③	2907③
94-95	6	4.3L	AWD	9028 ③	2907③
1993	6	4.3L		9184 ③	2907③
1992	6	4.3L	Code "Z" Eng., 2-1/2" Pipe	9529 ③	2906③
1992	6	4.3L	Code "W" Eng., 3" Pipe	9184 ③	2907③
86-91	6	4.3L		9002 ③	2906③
1985	6	4.3L		4001 ③	6906③
<b>GMC SIERRA 2500 HD CLASSIC</b>					
2007	8	6.0L	2500 HD Classic Models Only, 133" WB, Federal Emissions, Right Side, OE System is completely welded. Additional sizing, bushings, cutting may be required.	9990 ④	--
2007	8	6.0L	2500 HD Classic Models Only, 143.5", 153", 157.5", 167" WB, Federal Emissions, Right Side, OE System is completely welded. Additional sizing, bushings, cutting may be required.	9222 ④	--
2007	8	6.0L	2500 HD Classic Models Only, 133", 157.5", 167" WB, Federal Emissions, Left Side, OE System is completely welded. Additional sizing, bushings, cutting may be required.	9223 ④	--
2007	8	8.1L	2500 HD Classic Models Only, 133" WB, Federal Emissions, Right Side, OE System is completely welded. Additional sizing, bushings, cutting may be required.	9990 ④	--
2007	8	8.1L	2500 HD Classic Models Only, 143.5", 153", 157.5", 167" WB, Federal Emissions, Right Side, OE System is completely welded. Additional sizing, bushings, cutting may be required.	9222	--

③ Federal & California Emissions. Not For Sale or Use on vehicles licensed in the state of CA & NY (NY vehicles with CA Emissions). Check with your state authority for details.  
 ④ Federal Emissions. Not For Sale or Use on vehicles licensed in the state of CA. Check with your state authority.  
 ⑤ California Emissions. Not For Sale or Use on vehicles licensed in the state of CA & NY. Check with your state authority.



YR/YRS	CYL	LITER	DESCRIPTION	DIRECT FIT	UNIVERSAL
<b>GMC SIERRA 2500 HD CLASSIC (Cont.)</b>					
2007	8	8.1L	2500 HD Classic Models Only, 133", 157.5", 167" WB, Federal Emissions, Left Side, OE System is completely welded. Additional sizing, bushings, cutting may be required.	9223 ④ -- --	-- -- --
<b>GMC SIERRA 3500 CLASSIC</b>					
2007	8	6.0L	Cab-Chassis Classic Models Only, 133" W.B., Federal Emissions, Right Side, OE System is completely welded. Additional sizing, bushings, cutting may be required.	9990 ④ -- --	-- -- --
2007	8	6.0L	Cab-Chassis Classic Models Only, 157.5" & 167" W.B., Federal Emissions, Right Side, OE System is completely welded. Additional sizing, bushings, cutting may be required.	9222 ④ -- --	-- -- --
2007	8	6.0L	Cab-Chassis Classic Models Only; 133", 157.5", 167" W.B., Federal Emissions, Left Side, OE system is completely welded. Additional sizing, bushings, cutting may be required.	9223 ④ -- --	-- -- --
2007	8	8.1L	Cab-Chassis Classic Models Only, 133" W.B., Federal Emissions, Right Side, OE System is completely welded. Additional sizing, bushings, cutting may be required.	9990 ④ -- --	-- -- --
2007	8	8.1L	Cab-Chassis Classic Models Only, 157.5" & 167" W.B., Federal Emissions, Right Side, OE System is completely welded. Additional sizing, bushings, cutting may be required.	9222 ④ -- --	-- -- --
2007	8	8.1L	Cab-Chassis Classic Models Only; 133", 157.5", 167" W.B., Federal Emissions, Left Side, OE system is completely welded. Additional sizing, bushings, cutting may be required.	9223 ④ -- --	-- -- --
<b>GMC SUBURBAN/YUKON</b>					
2009	8	4.8L	Complete Assembly	9273 ③④	--
2009	8	4.8L	Front Left	--	2566③
2009	8	4.8L	Rear Conv.	--	2506R③
2009	8	4.8L	Front Right	--	2566③
2009	8	4.8L	Complete Assembly	9912 ③	--
07-08	8	4.8L	Federal Emissions	9233 ④	--
01-05	8	4.8L	Left, Federal Emissions	--	2506R④
01-05	8	4.8L	Right, Federal Emissions	--	2506R④
01-05	8	4.8L	Complete Assembly, Federal Emissions	9083 ④④	--
			Complete Assembly, Federal Emissions	9444 ③	--
83-87	8	5.0L		9002 ③	2906③
09-14	8	5.3L	Yukon & Yukon XL, Complete Assembly	9273 ③④	--
09-14	8	5.3L	Yukon & Yukon XL, Front Left	--	2566③
09-14	8	5.3L	Yukon & Yukon XL, Rear	--	2506R③
09-14	8	5.3L	Yukon & Yukon XL, Front Right	--	2566③
09-14	8	5.3L	Yukon & Yukon XL, Complete Assembly	9912 ③	--
07-08	8	5.3L	1/2 Ton Models, Federal Emissions	9233 ④	--
01-05	8	5.3L	Yukon & Yukon XL, Federal Emissions, Left	--	2506R④
01-05	8	5.3L	Yukon & Yukon XL, Federal Emissions, Complete Assembly	9083 ④④	--
			Yukon & Yukon XL, Federal Emissions, Complete Assembly	9444 ③	--
01-05	8	5.3L	Yukon & Yukon XL, Federal Emissions, Right	--	2506R④
98-00	8	5.7L	1/2 Ton Models, Dual Convs., to 9200 lbs GVW, Federal Emissions	9333 ④	2539④
96-99	8	5.7L	3/4 Ton Models, Front, to 9200 lbs GVW	9092 ③	2516③
96-99	8	5.7L	3/4 Ton Models, Rear, to 9200 lbs GVW	--	2516③
96-97	8	5.7L	1/2 Ton Models, Dual Convs., to 9200 lbs GVW	9333 ③	2539③

④ Discontinued, use until inventory is depleted.

③ Federal & California Emissions. Not For Sale or Use on vehicles licensed in the state of CA & NY (NY vehicles with CA Emissions). Check with your state authority for details.

④ Federal Emissions. Not For Sale or Use on vehicles licensed in the state of CA. Check with your state authority.

# APPLICATION LISTINGS

## FEDERAL CONVERTERS



YR/YRS	CYL	LITER	DESCRIPTION	DIRECT FIT	UNIVERSAL
<b>GMC SUBURBAN/YUKON (Cont.)</b>					
94-95	8	5.7L	To 8600 lbs GVW	9648 ③	2907③
88-93	8	5.7L	To 8600 lbs GVW	9184 ③	8007③
88-93	8	5.7L	To 11,000 lbs GVW	10903 ③	10907③
1987	8	5.7L	Fuel Injection	9184 ③	2907③
83-86	8	5.7L		9002 ③	2906③
07-08	8	6.0L	Yukon XL 1500, Federal Emissions	9233 ④	--
01-06	8	6.0L	Yukon Denali, Left	9267 ③	--
01-06	8	6.0L	Yukon Denali, Right	9266 ③	--
02-03	8	6.0L	Federal Emissions, Left	--	2540④
02-03	8	6.0L	Federal Emissions, Right	--	2540④
2000	8	6.0L	Yukon XL 2500, Right	9253 ③	--
96-99	8	7.4L	3/4 Ton Models, Front	9703 ③	8006③
96-99	8	7.4L	3/4 Ton Models, Rear	--	8006③
91-95	8	7.4L	To 8600 lbs GVW	9184 ③	8007③
91-95	8	7.4L	To 11,000 lbs GVW	10903 ③	10907③
87-89	8	7.4L	To 8600 lbs GVW	9184 ③	8007③
87-89	8	7.4L	To 11,620 lbs GVW	10903 ③	10907③
75-82	8	All		9002 ③	9006③
<b>GMC TERRAIN</b>					
10-15	4	2.4L	Rear	4012 ③	2576③
10-15	4	2.4L	Front	5221 ③	--
2012	6	3.0L	Manifold Unit, Front Left	1350 ③	--
10-12	6	3.0L	Rear	4692 ③	2576③
10-11	6	3.0L	Front Left	1206 ③	--
10-11	6	3.0L	Front Right	1207 ③	--
13-15	6	3.6L	Manifold Unit, Front Left	1350 ③	--
<b>HONDA ACCORD</b>					
84-85	4	1.8L		--	6804③
84-85	4	1.8L	Optional Direct Fit Converter	--	6804③
81-83	4	1.8L		4172 ③	6904R③
81-83	4	1.8L	Optional Direct Fit Converter	--	6904R③
1980	4	1.8L	12-1/2" Conv.	4172 ③	6904R③
1980	4	1.8L	Optional Direct Fit Converter	--	6904R③
86-89	4	2.0L	U.S. Models	4172 ③	6904R③
86-89	4	2.0L	Optional Direct Fit Converter	--	6904R③
86-87	4	2.0L	(Canada Model)	--	6904R③
96-97	4	2.2L	2 & 4 Dr., DX / LX / SE	4355 ③	2564R③
96-97	4	2.2L	LX Wagon	4355 ③	2564R③
96-97	4	2.2L	EX Sedan & Coupe	4355 ③	2564R③
94-95	4	2.2L	VTEC, DX / LX / EX Models	4586 ③	6904③
91-93	4	2.2L	14" Conv.	4472 ③	6904R③
91-93	4	2.2L	Optional Direct Fit Converter	4830 ③	6904R③
90-93	4	2.2L	13" Conv.	4471 ③	6904R③
90-93	4	2.2L	Optional Direct Fit Converter	4830 ③	6904R③
98-02	4	2.3L		4145 ③	2564R③
08-12	4	2.4L	California Emissions w/ Man. Trans., Rear	4774 ⑤	2576R⑤
08-12	4	2.4L	California Emissions w/ Man. Trans., Front	1174 ⑤	--

③ Federal & California Emissions. Not For Sale or Use on vehicles licensed in the state of CA & NY (NY vehicles with CA Emissions). Check with your state authority for details.

④ Federal Emissions. Not For Sale or Use on vehicles licensed in the state of CA. Check with your state authority.

⑤ California Emissions. Not For Sale or Use on vehicles licensed in the state of CA & NY. Check with your state authority.

YR/YRS	CYL	LITER	DESCRIPTION	DIRECT FIT	UNIVERSAL
<b>HONDA ACCORD (Cont.)</b>					
08-12	4	2.4L	Federal Emissions, Front	1174 ④	--
08-12	4	2.4L	Federal Emissions, Rear	4774 ④	2576R④
03-07	4	2.4L		4503 ③	2573R③
95-97	6	2.7L		4821 ③	2564R③
2007	6	3.0L	Special Edition, Front Left	1250 ③	--
			Special Edition, Front Left	1155 ③①	--
2007	6	3.0L	Special Edition, Front Right	1251 ③	--
			Special Edition, Front Right	1156 ③①	--
03-07	6	3.0L	EX & LX, Front Left	1250 ③	--
			EX & LX, Front Left	1155 ③①	--
03-07	6	3.0L	EX & LX, Front Right	1251 ③	--
			EX & LX, Front Right	1156 ③①	--
03-07	6	3.0L	Rear Main Conv.	4533 ③	2575R③①
00-02	6	3.0L		4209 ③	2565R③
98-99	6	3.0L	Federal Emissions	4253 ④	2565R④
98-99	6	3.0L	California Emissions	4233 ⑤	2565R⑤
08-15	6	3.5L	Front Left	1222 ③	--
08-15	6	3.5L	Front Right	1310 ③	--
13-14	6	3.5L	Center	5214 ③	--
10-12	6	3.5L	Rear	4010 ③	2545③
08-09	6	3.5L	Rear	4010 ④	2545④
<b>HONDA ACCORD CROSSTOUR</b>					
10-11	6	3.5L	Rear	4010 ③	2545③
10-11	6	3.5L	Front Right	1310 ③	--
10-11	6	3.5L	Front Left	1222 ③	--
<b>HONDA CIVIC</b>					
06-11	4	1.3L	Hybrid, Front	1318 ③	--
06-11	4	1.3L	Hybrid, Rear	4927 ③	--
03-05	4	1.3L	Hybrid Rear Conv., exc. models w/ NOX adsorptive converter	4984 ③	--
03-05	4	1.3L	Hybrid, Front	1274 ③	--
80-83	4	1.3L		4172 ③	6904R③
80-83	4	1.3L	Optional Direct Fit Converter	--	6904R③
94-95	4	1.5L	DX / SI, 3 Dr. Hatchback	4716 ③	6904R③
94-95	4	1.5L	Optional Direct Fit Converter	4828 ③	6904R③
92-95	4	1.5L	DX, Auto Trans.	4716 ③	6904R③
92-95	4	1.5L	Optional Direct Fit Converter	4828 ③	6904R③
1993	4	1.5L	DX / SI, 3 Dr. Hatchback	--	6904R③
92-93	4	1.5L	DX, (Exc. Auto Trans.)	--	6904R③
90-91	4	1.5L	3 Dr.	4178 ③	6904R③
90-91	4	1.5L	Optional Direct Fit Converter	4828 ③	6904R③
88-90	4	1.5L	DX	4178 ③	6904R③
88-90	4	1.5L	Optional Direct Fit Converter	4828 ③	6904R③
88-90	4	1.5L	4 Dr.	4178 ③	6904R③
88-90	4	1.5L	Optional Direct Fit Converter	4828 ③	6904R③
86-87	4	1.5L	EFI, SI 3 Dr.	--	6904③
80-83	4	1.5L		4172 ③	6904R③
80-83	4	1.5L	Optional Direct Fit Converter	--	6904R③

① Discontinued, use until inventory is depleted.

② Federal & California Emissions. Not For Sale or Use on vehicles licensed in the state of CA & NY (NY vehicles with CA Emissions). Check with your state authority for details.

③ Federal Emissions. Not For Sale or Use on vehicles licensed in the state of CA. Check with your state authority.

④ California Emissions. Not For Sale or Use on vehicles licensed in the state of CA & NY. Check with your state authority.

# APPLICATION LISTINGS

## FEDERAL CONVERTERS



YR/YRS	CYL	LITER	DESCRIPTION	DIRECT FIT	UNIVERSAL
<b>HONDA CIVIC (Cont.)</b>					
99-00	4	1.6L	SI or EX Models	4839 ③	2564R③
96-00	4	1.6L	CX, DX, LX	4340 ③	--
96-98	4	1.6L	EX / HX / SI	4231 ③	--
94-95	4	1.6L	DX / SI, 3 Dr. Hatchback	4716 ③	6904R③
94-95	4	1.6L	Optional Direct Fit Converter	4828 ③	6904R③
93-95	4	1.6L	EX Models	4716 ③	6904R③
93-95	4	1.6L	Optional Direct Fit Converter	4828 ③	6904R③
1992	4	1.6L	EX Coupe or Sedan	--	6904R③
90-91	4	1.6L	3 Dr.	4178 ③	6904R③
90-91	4	1.6L	Optional Direct Fit Converter	4828 ③	6904R③
89-90	4	1.6L	SI 3 Dr.	4178 ③	6904R③
89-90	4	1.6L	Optional Direct Fit Converter	4828 ③	6904R③
01-05	4	1.7L	(Exc. VTEC Eng.)	4230 ③	--
01-05	4	1.7L	EX Models	4227 ③	2574③○
			EX Models	--	2564R③□
10-11	4	1.8L	GX, Front	1203 ③	--
09-11	4	1.8L	EX-L & LX-S, Front	1203 ③	--
06-11	4	1.8L	DX, EX & LX; Front	1203 ③	--
06-11	4	2.0L	SI Models	4436 ③	2572R③○
88-89	4	All	Station Wgn.	4178 ③	6904R③
88-89	4	All	Optional Direct Fit Converter	4828 ③	6904R③
<b>HONDA CIVIC DEL SOL</b>					
93-95	4	1.5L		4716 ③	6904R③
93-95	4	1.5L	Optional Direct Fit Converter	4828 ③	6904R③
96-97	4	1.6L	S Models	4340 ③	--
93-95	4	1.6L		4716 ③	6904R③
93-95	4	1.6L	Optional Direct Fit Converter	4828 ③	6904R③
<b>HONDA CROSSTOUR</b>					
12-14	6	3.5L	Front Right	1310 ③	--
12-14	6	3.5L	Front Left	1222 ③	--
<b>HONDA CRV</b>					
99-01	4	2.0L		4249 ③	2564R③
97-98	4	2.0L		4249 ③	2564R③
10-11	4	2.4L	Front	1312 ③	--
07-09	4	2.4L		4622 ③	2571R③○
02-06	4	2.4L		4289 ③	2573R③○
				--	2564R③□
<b>HONDA CRX</b>					
88-91	4	1.5L	DX	4178 ③	6904R③
88-91	4	1.5L	Optional Direct Fit Converter	4828 ③	6904R③
85-87	4	1.5L	SI	--	6904③
88-91	4	1.6L	SI	4178 ③	6904R③
88-91	4	1.6L	Optional Direct Fit Converter	4828 ③	6904R③
<b>HONDA ELEMENT</b>					
03-11	4	2.4L		4560 ③	2571R③○

- ③ Federal & California Emissions. Not For Sale or Use on vehicles licensed in the state of CA & NY (NY vehicles with CA Emissions). Check with your state authority for details.
- EPA OBDII By Design Unit
- EPA Enhanced OBDII By Design Unit

YR/YRS	CYL	LITER	DESCRIPTION	DIRECT FIT	UNIVERSAL
<b>HONDA FIT</b>					
07-08	4	1.5L	Auto Trans.	4594 ③	--
<b>HONDA INSIGHT</b>					
00-06	3	1.0L	Hybrid Front Conv.	--	2225③
00-01	3	1.0L	Hybrid Front Conv., Manual Trans.	1113 ③	--
00-01	3	1.0L	Hybrid Rear Conv., Manual Trans.	4435 ③	--
10-14	4	1.3L	Rear	5202 ③	--
<b>HONDA ODYSSEY</b>					
96-97	4	2.2L		4249 ③	2564R③
1995	4	2.2L		4828 ③	6904R③
1998	4	2.3L		4363 ③	2564R③
11-14	6	3.5L	Rear	4010 ③	2545③
11-14	6	3.5L	Front Right	1310 ③	--
11-14	6	3.5L	Front Left	1222 ③	--
08-10	6	3.5L	EX & LX, Front Left	1250 ③	--
			EX & LX, Front Left	1155 ③①	--
08-10	6	3.5L	EX & LX, Front Right	1251 ③	--
			EX & LX, Front Right	1156 ③①	--
08-10	6	3.5L	EX-L & Touring, Front Left	1232 ③	--
08-10	6	3.5L	EX-L & Touring, Front Right	1233 ③	--
05-10	6	3.5L	Rear Main	4533 ③	2575R③②
05-07	6	3.5L	Front Left	1250 ③	--
			Front Left	1155 ③①	--
05-07	6	3.5L	Front Right	1251 ③	--
			Front Right	1156 ③①	--
99-04	6	3.5L		4209 ③	2565R③
<b>HONDA PASSPORT</b>					
94-95	4	2.6L		--	6906③
98-02	6	3.2L	Right, Auto Trans., Federal Emissions	4364 ④	2504R④
98-02	6	3.2L	Left, Auto Trans., Federal Emissions	4365 ④	2504R④
96-97	6	3.2L	Right, Auto Trans.	4968 ③	2564R③
96-97	6	3.2L	Left, Auto Trans.	4969 ③	2564R③
94-95	6	3.2L	Front, Auto Trans.	1075 ③	--
94-95	6	3.2L		4175 ③	6906③
<b>HONDA PILOT</b>					
09-15	6	3.5L	Front Left	1222 ③	--
09-14	6	3.5L	Rear	4010 ③	2545③
09-11	6	3.5L	Front Right	1310 ③	--
05-08	6	3.5L	Front Left	1250 ③	--
			Front Left	1155 ③①	--
05-08	6	3.5L	Front Right	1251 ③	--
			Front Right	1156 ③①	--
05-08	6	3.5L	Rear Main	4533 ③	2575R③
03-04	6	3.5L		4449 ③	2565R③
<b>HONDA PRELUDE</b>					
83-87	4	1.8L		--	6804③
83-87	4	1.8L	Optional Direct Fit Converter	--	6804③
81-82	4	1.8L		4172 ③	6904R③

① Discontinued, use until inventory is depleted.

② Federal & California Emissions. Not For Sale or Use on vehicles licensed in the state of CA & NY (NY vehicles with CA Emissions). Check with your state authority for details.

③ Federal Emissions. Not For Sale or Use on vehicles licensed in the state of CA. Check with your state authority.

④ EPA Enhanced OBDII By Design Unit

**APPLICATION LISTINGS  
FEDERAL CONVERTERS**



YR/YRS	CYL	LITER	DESCRIPTION	DIRECT FIT	UNIVERSAL
<b>HONDA PRELUDE (Cont.)</b>					
81-82	4	1.8L	Optional Direct Fit Converter	--	6904R <sup>③</sup>
1980	4	1.8L	Auto Trans.	4172 <sup>③</sup>	6904R <sup>③</sup>
1980	4	1.8L	Optional Direct Fit Converter, Auto Trans.	--	6904R <sup>③</sup>
1980	4	1.8L	Manual Trans.	--	6904 <sup>③</sup>
88-91	4	2.0L		4172 <sup>③</sup>	6904R <sup>③</sup>
88-91	4	2.0L	Optional Direct Fit Converter	--	6904R <sup>③</sup>
85-87	4	2.0L		4471 <sup>③</sup>	6904 <sup>③</sup>
85-87	4	2.0L	Optional Direct Fit Converter	4830 <sup>③</sup>	6904R <sup>③</sup>
97-01	4	2.2L		4504 <sup>③</sup>	2564R <sup>③</sup>
92-95	4	2.2L		4830 <sup>③</sup>	6904R <sup>③</sup>
1996	4	2.3L		--	2564R <sup>③</sup>
92-95	4	2.3L		--	6904R <sup>③</sup>
92-95	4	2.3L	Optional Direct Fit Converter	4830 <sup>③</sup>	6904R <sup>③</sup>
<b>HONDA RIDGELINE</b>					
09-14	6	3.5L	Front Left	1222 <sup>③</sup>	--
09-14	6	3.5L	Rear	4010 <sup>③</sup>	2545 <sup>③</sup>
09-11	6	3.5L	Front Right	1310 <sup>③</sup>	--
06-08	6	3.5L	Front Left	1250 <sup>③</sup>	--
			Front Left	1155 <sup>③⑩</sup>	--
06-08	6	3.5L	Front Right	1251 <sup>③</sup>	--
			Front Right	1156 <sup>③⑩</sup>	--
06-08	6	3.5L	Rear Main Conv.	4533 <sup>③</sup>	2575R <sup>③</sup>
<b>HONDA S2000</b>					
00-03	4	2.0L	VTEC Engine	4973 <sup>③</sup>	--
04-05	4	2.2L		4973 <sup>③</sup>	--
<b>HUMMER H2</b>					
2007	8	6.0L		9976 <sup>③</sup>	--
03-06	8	6.0L	Right	9166 <sup>③</sup>	--
03-06	8	6.0L	Left	9167 <sup>③</sup>	--
2008	8	6.2L		9976 <sup>③</sup>	--
<b>HUMMER H3</b>					
2006	5	3.5L	Front	4487 <sup>③</sup>	--
07-08	5	3.7L	Manifold Unit, Front	1226 <sup>③</sup>	--
2007	5	3.7L	Rear	9216 <sup>③</sup>	2575R <sup>③</sup>
08-10	8	5.3L	Left	9549 <sup>③</sup>	--
08-10	8	5.3L	Right	9550 <sup>③</sup>	--
<b>HYUNDAI ACCENT</b>					
00-02	4	1.5L	Manifold Conv.	4235 <sup>③</sup>	--
98-99	4	1.5L	SOHC	4251 <sup>③</sup>	--
96-97	4	1.5L	SOHC	4889 <sup>③</sup>	2504R <sup>③</sup>
96-97	4	1.5L	DOHC	4889 <sup>③</sup>	2504R <sup>③</sup>
1995	4	1.5L	SOHC	4889 <sup>③</sup>	6904R <sup>③</sup>
12-14	4	1.6L	Rear Conv., Requires Resonator Pipe 58555 to Complete Installation, As OE was a One Piece Welded Assembly	4933 <sup>③</sup>	2538 <sup>③</sup>
				--	--
10-11	4	1.6L	Rear Conv.	4730 <sup>③</sup>	--
06-10	4	1.6L	Manifold Conv.	4611 <sup>③</sup>	--
06-09	4	1.6L	Rear Conv.	5001 <sup>③</sup>	--

⑩ Discontinued, use until inventory is depleted.

③ Federal & California Emissions. Not For Sale or Use on vehicles licensed in the state of CA & NY (NY vehicles with CA Emissions). Check with your state authority for details.

YR/YRS	CYL	LITER	DESCRIPTION	DIRECT FIT	UNIVERSAL
<b>HYUNDAI ACCENT (Cont.)</b>					
01-05	4	1.6L	Manifold Conv.	4412 ③	--
<b>HYUNDAI AZERA</b>					
07-08	6	3.3L	Manifold Unit, Front	1178 ③	--
07-08	6	3.3L	Rear Manifold Conv.	1179 ③	--
06-10	6	3.8L	Manifold Unit, Front	1178 ③	--
06-10	6	3.8L	Rear Manifold Conv.	1179 ③	--
06-09	6	3.8L	Rear Main Conv.	4461 ③	2565R③
<b>HYUNDAI ELANTRA</b>					
92-95	4	1.6L		4377 ③	6904③
1998	4	1.8L		4165 ③	--
96-98	4	1.8L		4889 ③	2504R③
93-94	4	1.8L		4377 ③	6904③
04-12	4	2.0L	Straight Outlet, Manifold Unit, Front	1234 ③	--
			Straight Outlet, Manifold Unit, Front	1162 ③①	--
06-10	4	2.0L	Manifold Conv. w/ Curved Outlet, Calif. Emissions	1180 ⑤	--
07-08	4	2.0L	Rear, Federal Emissions	5000 ④	--
06-08	4	2.0L	Rear, California Emission	5131 ⑤	2575R⑤
04-05	4	2.0L	Rear, OAL 14 3/4", California Emissions	4808 ⑤	2504R⑤
04-05	4	2.0L	Rear, Federal Emissions	4729 ④	2504R④
01-05	4	2.0L	Manifold Conv. w/ Curved Outlet, Calif. Emissions	1062 ⑤	--
01-05	4	2.0L	Manifold Conv. w/ Curved Outlet, Federal Emissions	1062 ④	--
2003	4	2.0L	Rear, Federal Emissions	4262 ④	2504R④
2003	4	2.0L	W/ CVT Engine, Straight Outlet, Manifold Unit, Front	1234 ③	--
			W/ CVT Engine, Straight Outlet, Manifold Unit, Front	1162 ③①	--
01-03	4	2.0L	Rear, California Emissions	4662 ⑤	2504R⑤
01-02	4	2.0L	Rear, Federal Emissions	--	2504R④
99-00	4	2.0L	Front	4165 ③	--
99-00	4	2.0L	Rear, California Emissions	4889 ⑤	2504⑤
<b>HYUNDAI ENTOURAGE</b>					
07-08	6	3.8L	Manifold Unit, Front	1178 ③	--
07-08	6	3.8L	Rear Manifold Conv.	1179 ③	--
07-08	6	3.8L	Rear Main Conv.	4726 ③	--
<b>HYUNDAI EXCEL</b>					
90-94	4	1.5L		4203 ③	6904R③
86-89	4	1.5L	Rear, w/Air Tube	--	6004③
86-89	4	1.5L	Rear, w/o Air Tube	--	6904③
86-89	4	1.5L	Main & Pre-Cat	--	6004③
<b>HYUNDAI GENESIS COUPE</b>					
10-12	4	2.0L	Front	1326 ③	--
<b>HYUNDAI SANTA FE</b>					
10-12	4	2.4L	Rear	4710 ③	2574R③
01-04	4	2.4L	Front	1018 ③	--
01-04	4	2.4L	Rear	4228 ③	2505R③
07-09	6	2.7L	Manifold Unit, Front	1339 ③	--
			Manifold Unit, Front	1142 ③①	--
07-09	6	2.7L	Rear Manifold Conv.	1228 ③	--
			Rear Manifold Conv.	1143 ③①	--

① Discontinued, use until inventory is depleted.

③ Federal & California Emissions. Not For Sale or Use on vehicles licensed in the state of CA & NY (NY vehicles with CA Emissions). Check with your state authority for details.

④ Federal Emissions. Not For Sale or Use on vehicles licensed in the state of CA. Check with your state authority.

⑤ California Emissions. Not For Sale or Use on vehicles licensed in the state of CA & NY. Check with your state authority.

# APPLICATION LISTINGS

## FEDERAL CONVERTERS



YR/YRS	CYL	LITER	DESCRIPTION	DIRECT FIT	UNIVERSAL
<b>HYUNDAI SANTA FE (Cont.)</b>					
07-09	6	2.7L	Rear Main Conv.	4643 ③	--
01-06	6	2.7L	Rear Manifold Conv.	1260 ③	--
01-06	6	2.7L	Rear Main Conv.	4161 ③	2540③
01-04	6	2.7L	Manifold Unit, Front	1261 ③	--
07-09	6	3.3L	Rear	4926 ③	--
07-09	6	3.3L	Front Left Manifold Conv.	1220 ③	--
07-09	6	3.3L	Front Right Manifold Conv.	1221 ③	--
03-06	6	3.5L	Rear Main Conv.	5022 ③	--
03-06	6	3.5L	Front Right	1176 ③	--
			Front Right	1141 ③①	--
03-06	6	3.5L	Front Left	1175 ③	--
			Front Left	1140 ③①	--
2004	6	3.5L	Rear Main Conv.	4541 ③①	--
<b>HYUNDAI SCOUPE</b>					
93-95	4	1.5L	Turbo	4377 ③	6904③
91-95	4	1.5L	(Exc. Turbo)	4203 ③	6904R③
<b>HYUNDAI SONATA</b>					
96-98	4	2.0L		4238 ③	2505③
92-95	4	2.0L		4377 ③	6904③
11-14	4	2.4L	Hybrid, Hybrid Limited, Rear	5132 ③	2565R③
2011	4	2.4L	Federal Emissions, Exc. Hybrid	4608 ④	--
2010	4	2.4L	Federal Emissions, Rear	4727 ③	--
09-10	4	2.4L	California Emissions, w/o Center O2 Port, Rear	5132 ⑤	2565R⑤
2009	4	2.4L	Federal Emissions, Rear	4348 ④	2574R④①
			Federal Emissions, Rear	--	2564R④□
06-08	4	2.4L		4348 ③	2574R③①
				--	2564R④□
06-07	4	2.4L	Front	1098 ③	--
99-05	4	2.4L	Front	1018 ③	--
99-05	4	2.4L	Rear	4358 ③	2505③
89-91	4	2.4L		4377 ③	6904③
99-01	6	2.5L	Front Manifold Conv., w/ Curved Outlet	1024 ③	--
99-01	6	2.5L	Rear Manifold Conv., w/ Curved Outlet	1025 ③	--
99-01	6	2.5L	Rear Main Conv.	4224 ③	2504③
02-05	6	2.7L	Front Manifold Conv., w/ Curved Outlet	1024 ③	--
02-05	6	2.7L	Rear Manifold Conv., w/ Curved Outlet	1025 ③	--
1996	6	3.0L		4238 ③	2505③
90-95	6	3.0L		--	6904③
09-10	6	3.3L	Rear	5134 ③	2575R③
2008	6	3.3L	Rear	4926 ③	--
06-07	6	3.3L	Manifold Unit, Front	1178 ③	--
06-07	6	3.3L	Federal Emissions, Rear	4807 ④	--
06-07	6	3.3L	Rear Manifold Conv.	1179 ③	--
<b>HYUNDAI STELLAR</b>					
85-86	4	1.6L	(Canada Model)	--	6004③
1987	4	2.0L	(Canada Model)	--	6004③

- ① Discontinued, use until inventory is depleted.
- ③ Federal & California Emissions. Not For Sale or Use on vehicles licensed in the state of CA & NY (NY vehicles with CA Emissions). Check with your state authority for details.
- ④ Federal Emissions. Not For Sale or Use on vehicles licensed in the state of CA. Check with your state authority.
- ⑤ California Emissions. Not For Sale or Use on vehicles licensed in the state of CA & NY. Check with your state authority.
- EPA OBDII By Design Unit
- EPA Enhanced OBDII By Design Unit



YR/YRS	CYL	LITER	DESCRIPTION	DIRECT FIT	UNIVERSAL
<b>HYUNDAI TIBURON</b>					
1997	4	1.8L	Rear, M Eng.	4889 ③	2504 ③
07-08	4	2.0L	Straight Outlet, Manifold Unit, Front	1234 ③	--
03-06	4	2.0L	Manifold Conv.	1062 ③	--
03-06	4	2.0L	Rear, Federal Emissions	4262 ④	2575R ④○
			Rear, Federal Emissions	--	2504R ④□
03-06	4	2.0L	Rear, California Emission	4662 ③	2504R ③
98-01	4	2.0L	Models w/1 Piece Manifold Conv.; From 8/16/98	4165 ③	--
98-01	4	2.0L	Rear, California Emissions	4889 ⑤	--
03-05	6	2.7L	Manifold Unit, Front	1024 ③	--
03-05	6	2.7L	Rear Manifold Conv.	1051 ③	--
03-05	6	2.7L	Rear Main Conv.	4324 ③	2505 ③
<b>HYUNDAI TUCSON</b>					
05-08	4	2.0L	Rear	4724 ③	--
05-06	4	2.0L	Manifold Conv.	1181 ③	--
05-09	6	2.7L	Left Manifold Conv., Up To 01/01/09	1129 ③	--
05-09	6	2.7L	FWD, Right Manifold Conv.	1209 ③	--
			FWD, Right Manifold Conv.	1128 ③⑩	--
05-08	6	2.7L	Rear	4725 ③	--
05-08	6	2.7L	4WD, Manifold Unit, Front Right	1341 ③	--
<b>HYUNDAI VELOSTER</b>					
12-15	4	1.6L	Naturally Aspirated, Rear	5061 ③	--
<b>HYUNDAI VERACRUZ</b>					
07-12	6	3.8L	Manifold Unit, Front Left	1220 ③	--
07-12	6	3.8L	Manifold Unit, Front Right	1221 ③	--
07-12	6	3.8L	Rear	4926 ③	--
<b>HYUNDAI XG300</b>					
2001	6	3.0L	Manifold Unit, Front	1070 ③	--
2001	6	3.0L	Rear Manifold Conv.	1089 ③	--
2001	6	3.0L		4485 ③	2565R ③
<b>HYUNDAI XG350</b>					
02-05	6	3.5L	Rear Conv.	4485 ③	2565R ③
02-03	6	3.5L	Front Manifold	1070 ③	--
02-03	6	3.5L	Rear Manifold	1089 ③	--
<b>INFINITI FX35</b>					
03-08	V6	3.5L	Left	4193 ③	--
03-08	V6	3.5L	Right	4192 ③	--
<b>INFINITI FX45</b>					
07-08	8	4.5L	Rear Right	5186 ③	--
07-08	8	4.5L	Rear Left	5185 ③	--
03-08	8	4.5L	Front Right	4670 ③	--
03-08	8	4.5L	Front Left	4671 ③	--
2005	8	4.5L	Rear Right	4770 ③	--
2005	8	4.5L	Rear Left	4771 ③	--
<b>INFINITI G20</b>					
00-02	4	2.0L		4317 ③	2545 ③
91-94	4	2.0L		4408 ☆③	6905 ③

⑩ Discontinued, use until inventory is depleted.

☆ Air Tube kit 4948 may be required for installation.

③ Federal & California Emissions. Not For Sale or Use on vehicles licensed in the state of CA & NY (NY vehicles with CA Emissions). Check with your state authority for details.

④ Federal Emissions. Not For Sale or Use on vehicles licensed in the state of CA. Check with your state authority.

⑤ California Emissions. Not For Sale or Use on vehicles licensed in the state of CA & NY. Check with your state authority.

□ EPA OBDII By Design Unit

○ EPA Enhanced OBDII By Design Unit

**APPLICATION LISTINGS  
FEDERAL CONVERTERS**



YR/YRS	CYL	LITER	DESCRIPTION	DIRECT FIT	UNIVERSAL
<b>INFINITI G35</b>					
03-07	6	3.5L	Right	4192 ③	--
03-07	6	3.5L	Left	4193 ③	--
<b>INFINITI I30</b>					
00-01	6	3.0L	Front, California Emissions	1014 ⑤	--
00-01	6	3.0L	Middle Conv., California Emissions	4014 ⑤	--
00-01	6	3.0L	Rear, California Emissions	4317 ⑤	2545 ⑤
1999	6	3.0L	California Emissions, Center	5155 ⑤	--
96-99	6	3.0L	Rear	4841 ③	2540 ③
96-98	6	3.0L	Front	4941 ③	--
<b>INFINITI I35</b>					
02-04	6	3.5L	Manifold Unit, Front	1078 ③	--
02-04	6	3.5L	Rear Manifold Conv.	1079 ③	--
02-04	6	3.5L	Rear Main Conv.	4368 ③	--
<b>INFINITI J30</b>					
93-97	6	3.0L	Right, (Includes '97 J30t)	4422 ③	2504 ③
93-97	6	3.0L	Left, (Includes '97 J30t)	4423 ③	2504 ③
<b>INFINITI M30</b>					
90-92	6	3.0L		--	6905 ③
<b>INFINITI M35</b>					
06-08	6	3.5L	Right	4192 ③	--
06-08	6	3.5L	Left	4193 ③	--
<b>INFINITI M45</b>					
06-10	8	4.5L	Manifold Unit, Front Right	4670 ③	--
06-10	8	4.5L	Manifold Unit, Front Left	4671 ③	--
03-04	8	4.5L	Rear Main Conv.	4615 ③	--
<b>INFINITI Q45</b>					
02-06	8	4.5L	Rear Main Conv.	4615 ③	--
02-05	8	4.5L	Left	--	2538 ③
02-05	8	4.5L	Right	--	2538 ③
2002	8	4.5L	Right Manifold Conv.	1131 ③	--
90-95	8	4.5L	Rear-Left	--	2904 ③
90-95	8	4.5L	Rear-Right	--	2904 ③
<b>INFINITI QX4</b>					
98-00	6	3.3L	Rear Right, California Emissions	4318 ⑤	2504 ⑤
98-00	6	3.3L	Rear Left, California Emissions	4319 ⑤	2504 ⑤
97-00	6	3.3L	Front, Right	1016 ③	--
97-00	6	3.3L	Front, Left	1015 ③	--
01-03	6	3.5L	Front Right	1118 ③	--
01-03	6	3.5L	Front Left	1015 ③	--
2001	6	3.5L	Rear Right	4318 ③	2504 ③
2001	6	3.5L	Rear Left	4319 ③	2504 ③
<b>INFINITI QX56</b>					
07-10	8	5.6L	Rear Right	4758 ③	2575 ③
07-10	8	5.6L	Rear Left	4005 ③	2575 ③
04-06	V8	5.6L	Manifold Unit, Right	4739 ③	--
04-06	V8	5.6L	Manifold Unit, Left	4738 ③	--
04-06	V8	5.6L	Without Flex, US EPA, BIN 8, SULEV Emissions, Right Rear	4758 ③	2575 ③

③ Federal & California Emissions. Not For Sale or Use on vehicles licensed in the state of CA & NY (NY vehicles with CA Emissions). Check with your state authority for details.  
 ⑤ California Emissions. Not For Sale or Use on vehicles licensed in the state of CA & NY. Check with your state authority.

YR/YRS	CYL	LITER	DESCRIPTION	DIRECT FIT	UNIVERSAL
<b>INFINITI QX56 (Cont.)</b>					
04-06	V8	5.6L	Without Flex, US EPA, BIN 8, SULEV Emissions, Left Rear	4759 ③	2575③
<b>INTERNATIONAL HARVESTER</b>					
79-80	6	All		--	6906③
79-80	8	5.0L		--	6906③
79-80	8	5.6L		--	8006③
<b>ISUZU AMIGO</b>					
98-00	4	2.2L	Federal Emissions	4506 ④	--
89-93	4	2.3L		4175 ③	6906③
89-94	4	2.6L		4175 ③	6906③
<b>ISUZU ASCENDER</b>					
06-07	6	4.2L	Non-Extended Wheelbase, 113" W.B.	9171 ③	2506③
04-05	6	4.2L	Non-Extended Wheelbase, 113" W.B.	9154 ③	2506R③
04-05	6	4.2L	Extended Wheelbase, 129" W.B.	9998 ③	2506R③
2006	8	5.3L		9544 ③	--
<b>ISUZU I-280</b>					
2006	4	2.8L	Rear	9216 ③	2575R③
2006	4	2.8L	Front	1216 ③	--
<b>ISUZU I-290</b>					
07-08	4	2.9L	Manifold Unit, Front	1227 ③	--
<b>ISUZU I-350</b>					
2006	5	3.5L	Rear	9216 ③	2575R③
2006	5	3.5L	Front	4487 ③	--
<b>ISUZU I-370</b>					
07-08	5	3.7L	Front Main Conv.	1226 ③	--
<b>ISUZU I-MARK</b>					
87-89	4	1.5L	Turbo, Rear	--	6805③
85-89	4	1.5L	(Exc. Turbo), Rear	--	6906③
85-89	4	1.5L	(Exc. Turbo), Optional Direct Fit Converter	4175 ③	6906③
1989	4	1.6L	DOHC	--	6904③
81-85	4	1.8L		--	6906③
81-85	4	1.8L	Optional Direct Fit Converter	4175 ③	6906③
<b>ISUZU IMPULSE</b>					
90-92	4	1.6L		4175 ③	6906③
1992	4	1.8L		4175 ③	6906③
83-86	4	1.9L		4175 ③	6906③
87-89	4	2.0L		4175 ③	6906③
85-86	4	2.0L		4175 ③	6906③
88-89	4	2.3L		4175 ③	6906③
<b>ISUZU OASIS</b>					
96-97	4	2.2L		4249 ③	2564R③
98-99	4	2.3L		4363 ③	2564R③
<b>ISUZU PICKUP</b>					
96-00	4	2.2L	Hombre Models	4819 ③	2505③
86-95	4	2.3L		4175 ③	6906③
88-95	4	2.6L	(Exc. 27-1/2" Conv.)	4175 ③	6906③
81-87	4	All		4175 ③	6906③
91-94	6	3.1L		4175 ③	6906③

③ Federal & California Emissions. Not For Sale or Use on vehicles licensed in the state of CA & NY (NY vehicles with CA Emissions). Check with your state authority for details.

④ Federal Emissions. Not For Sale or Use on vehicles licensed in the state of CA. Check with your state authority.

**APPLICATION LISTINGS**  
**FEDERAL CONVERTERS**



YR/YRS	CYL	LITER	DESCRIPTION	DIRECT FIT	UNIVERSAL
<b>ISUZU PICKUP (Cont.)</b>					
98-99	6	4.3L	Hombre 2WD, w/ 31 1/2" OAL Conv.	4977 ③	2516③
98-99	6	4.3L	Hombre 4WD	9881 ③	2516③
98-99	6	4.3L	Hombre, 2WD & Extended Cab, California Emissions	1177 ⑤	2564R⑤
1997	6	4.3L	Hombre 2WD	9710 ③	2516③
<b>ISUZU RODEO</b>					
01-03	4	2.2L		5043 ③	--
98-00	4	2.2L	Federal Emissions	4506 ④	--
91-95	4	2.6L		4175 ③	6906③
91-92	6	3.1L		4175 ③	6906③
98-02	6	3.2L	Right, Auto Trans., Federal Emissions	4364 ④	2505④
98-02	6	3.2L	Left, Auto Trans., Federal Emissions	4365 ④	2505④
96-97	6	3.2L	Right, Auto Trans.	4968 ③	2564R③
96-97	6	3.2L	Left, Auto Trans.	4969 ③	2564R③
94-95	6	3.2L	Front, 4WD Auto Trans.	1075 ③	--
94-95	6	3.2L		4175 ③	6804③
1993	6	3.2L	Front, 4WD Auto Trans., California Emissions	1075 ⑤	--
1993	6	3.2L	Rear, 4WD Auto Trans., California Emissions	4175 ⑤	6804⑤
<b>ISUZU RODEO SPORT</b>					
01-03	4	2.2L		5043 ③	--
<b>ISUZU STYLUS</b>					
91-93	4	All		--	6906③
<b>ISUZU TROOPER</b>					
84-91	4	All		--	6906③
89-91	6	2.8L		4175 ③	6906③
92-95	6	3.2L	Main Conv.	--	6906③
00-02	6	3.5L	Without Torque Control, Right Side	5011 ③	--
98-02	6	3.5L	Left	5010 ③	2564R③
98-99	6	3.5L	Auto Trans., Right Side	5011 ③	--
<b>ISUZU VEHICROSS</b>					
99-01	6	3.5L	Left	5010 ③	2564R③
<b>JAGUAR S-TYPE</b>					
00-02	6	3.0L	Right	4420 ③	--
00-02	6	3.0L	Left	4421 ③	--
00-02	8	4.0L	Left	4219 ③	2504③
00-02	8	4.0L	Right	4218 ③	2504③
<b>JAGUAR VANDEN PLAS</b>					
04-06	6	4.2L	Naturally Aspirated, Right	9541 ③	--
04-06	6	4.2L	Naturally Aspirated, Left	9540 ③	--
<b>JAGUAR X-TYPE</b>					
02-03	6	2.5L	Front Right	1316 ③	--
02-03	6	2.5L	Front Left	1315 ③	--
02-03	6	3.0L	Front Left	1315 ③	--
02-03	6	3.0L	Front Right	1316 ③	--
<b>JAGUAR XJ6</b>					
90-94	6	4.0L	Front Left	--	6904R③
90-94	6	4.0L	Rear Left	--	2904③
90-94	6	4.0L	Front Right	--	6904R③

③ Federal & California Emissions. Not For Sale or Use on vehicles licensed in the state of CA & NY (NY vehicles with CA Emissions). Check with your state authority for details.

④ Federal Emissions. Not For Sale or Use on vehicles licensed in the state of CA. Check with your state authority.

⑤ California Emissions. Not For Sale or Use on vehicles licensed in the state of CA & NY. Check with your state authority.

YR/YRS	CYL	LITER	DESCRIPTION	DIRECT FIT	UNIVERSAL
<b>JAGUAR XJ6 (Cont.)</b>					
90-94	6	4.0L	Rear Right	--	2904③
90-92	6	4.0L	Rear, DOHC	--	2904③
<b>JAGUAR XJ8</b>					
04-06	6	4.2L	Naturally Aspirated, Right	9541 ③	--
04-06	6	4.2L	Naturally Aspirated, Left	9540 ③	--
<b>JAGUAR XJ12</b>					
94-96	12	6.0L	Right	4569 ③	--
94-96	12	6.0L	Rear	4567 ③	--
78-79	12	All	Left	--	6904R③
78-79	12	All	Right	--	6904R③
75-77	12	All	Left	--	6904R③
75-77	12	All	Right	--	6904R③
<b>JAGUAR XJS</b>					
80-92	12	All	Front Left	--	6904R③
80-92	12	All	Rear Left	--	2904③
80-92	12	All	Front Right	--	6904R③
80-92	12	All	Rear Right	--	2904③
78-79	12	All	Left	--	6904R③
78-79	12	All	Right	--	6904R③
76-77	12	All	Left	--	6904R③
76-77	12	All	Right	--	6904R③
<b>JEEP CHEROKEE</b>					
96-00	4	2.5L	w/o Converter Flanges	9327 ③	2516③
93-95	4	2.5L		4555 ③	6905③
86-92	4	2.5L		4029 ③	6905③
84-85	4	2.5L		4469 ☆③	6904③
84-86	6	2.8L		4469 ☆③	6905③
00-01	6	4.0L	Front; From 01/20/00	1031 ③	--
00-01	6	4.0L	Rear; From 01/20/00	9231 ③	2516③
96-00	6	4.0L	To 01/20/00	9327 ③	2516③
93-95	6	4.0L		4555 ③	6905③
87-92	6	4.0L		4029 ③	6905③
82-83	6	4.2L		--	6004③
1981	6	4.2L	(Exc. w/ 2-1/2" Pipe)	--	6004③
79-81	6	4.2L		--	6906③
81-83	8	5.9L		--	9004③
79-80	8	5.9L		--	9006③
1978	8	5.9L		--	2906③
<b>JEEP CJ</b>					
84-86	4	2.5L		--	6004③
80-83	4	2.5L		--	6906③
82-86	6	4.2L		--	6004③
80-81	6	4.2L	w/Air Tube	--	6006③
80-81	6	4.2L	w/o Air Tube	--	6906③
1979	6	4.2L		--	6906③
75-78	6	All		--	9006③
1981	8	5.0L		4117 ②③	6904③

☆ Air Tube kit 4948 may be required for installation.

② When using with aftermarket piping, direct fit converter may require INLET/OUTLET pipe resizing.

③ Federal & California Emissions. Not For Sale or Use on vehicles licensed in the state of CA & NY (NY vehicles with CA Emissions). Check with your state authority for details.

# APPLICATION LISTINGS

## FEDERAL CONVERTERS



YR/YRS	CYL	LITER	DESCRIPTION	DIRECT FIT	UNIVERSAL
<b>JEEP CJ (Cont.)</b>					
79-80	8	5.0L		--	6905③
75-78	8	5.0L		--	6906③
<b>JEEP COMANCHE</b>					
1986	4	2.5L		4029 ③	6905③
1986	6	2.8L		4469 ☆③	6004③
87-92	4,6	All		4029 ③	6905③
<b>JEEP COMMANDER</b>					
08-10	6	3.7L		9460 ③	--
06-07	6	3.7L		9193 ③	--
2006	6	4.7L		4626 ③	--
2008	8	5.7L	Complete Assembly	4677 ③	--
06-07	8	5.7L		9448 ③	--
<b>JEEP COMPASS</b>					
07-11	4	2.0L	FWD	4415 ③	2571R③○
07-08	4	2.0L	4WD, Front	1110 ③	--
07-08	4	2.0L	4WD, Rear	9218 ③	--
07-11	4	2.4L	FWD	4415 ③	2571R③○
07-10	4	2.4L	4WD, Front	1110 ③	--
07-09	4	2.4L	4WD, Rear	9218 ③	--
<b>JEEP GRAND CHEROKEE/GRAND WAGONEER</b>					
07-09	6	3.7L		9460 ③	--
05-06	6	3.7L		9193 ③	--
02-04	6	4.0L	Front	1039 ③	--
02-04	6	4.0L		9139 ③	2516③
2001	6	4.0L	Front, Federal Emissions	1039 ④	--
2001	6	4.0L		9156 ③	2516③
96-00	6	4.0L	w/o Flange	9327 ③	2516③
93-95	6	4.0L		4555 ③	6905③
84-86	6	4.2L		--	6004③
05-06	8	4.7L		4626 ③	--
02-04	8	4.7L	Rear, Federal Emissions	9139 ④	2516④
02-04	8	4.7L	Front	4773 ③	--
2001	8	4.7L	Front	1097 ③	--
2001	8	4.7L		9156 ③	2516④
99-00	8	4.7L	Front, California Emissions	1097 ⑤	--
99-00	8	4.7L	Rear, California Emissions	9156 ⑤	2516⑤
99-00	8	4.7L	Federal Emissions	9156 ④	2516④
96-98	8	5.2L	w/o Flange	9327 ③	2540③
93-95	8	5.2L		4681 ③	6905③
05-10	8	5.7L		9448 ③	--
1998	8	5.9L	w/o Flange	9327 ③	2540③
84-91	8	5.9L		9182 ☆③	2906③
<b>JEEP J-Series PICKUP</b>					
82-86	6	4.2L		--	6004③
1981	6	4.2L	w/Air Tube	--	6004③
1981	6	4.2L	w/o Air Tube	--	6905③
79-80	6	4.2L		--	6905③

☆ Air Tube kit 4948 may be required for installation.

③ Federal & California Emissions. Not For Sale or Use on vehicles licensed in the state of CA & NY (NY vehicles with CA Emissions). Check with your state authority for details.

④ Federal Emissions. Not For Sale or Use on vehicles licensed in the state of CA. Check with your state authority.

⑤ California Emissions. Not For Sale or Use on vehicles licensed in the state of CA & NY. Check with your state authority.

○ EPA Enhanced OBDII By Design Unit

YR/YRS	CYL	LITER	DESCRIPTION	DIRECT FIT	UNIVERSAL
<b>JEEP J-Series PICKUP (Cont.)</b>					
81-88	8	5.9L		--	6004③
79-80	8	5.9L		--	6905③
<b>JEEP LIBERTY</b>					
2008	6	3.7L	Complete Assembly	9239 ③	--
2008	6	3.7L	Right	--	2573R③○
2008	6	3.7L	Left	--	2571R③○
2007	6	3.7L	Complete Assembly	9161 ③④	--
05-07	6	3.7L	Left	--	2505R③
05-07	6	3.7L	Right	--	2505R③
05-07	6	3.7L		9913 ③	--
2006	6	3.7L	Federal Emissions, Complete Assembly	9161 ④④	--
2005	6	3.7L	Complete Assembly	9161 ③④	--
2004	6	3.7L	Right	9158 ③	2565R③○
2004	6	3.7L	Left	9159 ③	2565R③○
02-03	6	3.7L	Front Left, To 02/14/03	1049 ③	--
02-03	6	3.7L	Front Right, To 02/14/03	1048 ③	--
02-03	6	3.7L	Rear, To 02/14/03	5003 ③	2540③
<b>JEEP PATRIOT</b>					
07-11	4	2.0L	FWD	4415 ③	2571R③○
07-08	4	2.0L	4WD, Manifold Unit, Front	1110 ③	--
07-08	4	2.0L	4WD, Rear	9218 ③	--
2010	4	2.4L	FWD	4415 ③	2571R③○
07-09	4	2.4L	FWD	4415 ③	2571R③○
07-08	4	2.4L	4WD, Manifold Unit, Front	1110 ③	--
07-08	4	2.4L	4WD, Rear	9218 ③	--
<b>JEEP SCRAMBLER</b>					
84-85	4	2.5L		--	6004③
81-83	4	2.5L		--	6905③
82-85	6	4.2L		--	6004③
1981	6	4.2L	w/Air Tube	--	6004③
1981	6	4.2L	w/o Air Tube	--	6905③
<b>JEEP WAGONEER</b>					
86-87	4	2.5L		4029 ③	6905③
84-85	4	2.5L	w/Air Tube	4469 ☆③	6004③
84-86	6	2.8L		4469 ☆③	6004③
87-90	6	4.0L		4029 ③	6905③
82-83	6	4.2L		--	6004③
80-81	6	4.2L	w/Air Tube	--	6004③
80-81	6	4.2L	w/o Air Tube	--	6905③
81-83	8	5.9L		--	6004③
79-80	8	5.9L		--	6905③
1978	8	5.9L		--	2906③
<b>JEEP WRANGLER</b>					
01-02	4	2.5L	Rear Main Conv., w/O2 Sensor	9030 ③	--
99-00	4	2.5L	w/Front Pipe	9105 ③	2540③
97-99	4	2.5L	w/o Front Pipe, Additional sizing, bushings, cutting may be required due to OE exhaust design.	9150 ③	2540③
				--	--

④ Discontinued, use until inventory is depleted.

☆ Air Tube kit 4948 may be required for installation.

③ Federal & California Emissions. Not For Sale or Use on vehicles licensed in the state of CA & NY (NY vehicles with CA Emissions). Check with your state authority for details.

④ Federal Emissions. Not For Sale or Use on vehicles licensed in the state of CA. Check with your state authority.

160 ○ EPA Enhanced OBDII By Design Unit

# APPLICATION LISTINGS

## FEDERAL CONVERTERS



YR/YRS	CYL	LITER	DESCRIPTION	DIRECT FIT	UNIVERSAL
<b>JEEP WRANGLER (Cont.)</b>					
97-98	4	2.5L	w/Front Pipe	9099 ③	2540③
93-95	4	2.5L		4684 ③	2905③
87-92	4	2.5L		4029 ③	6905③
07-09	6	3.8L		9420 ③	--
04-06	6	4.0L		9170 ③	--
00-03	6	4.0L	Front	1030 ③	--
00-03	6	4.0L	Rear Main Conv., w/O2 Sensor	9030 ③	2540③
00-03	6	4.0L	Rear Main Conv., w/o O2 Sensor	9014 ③	2540③
97-00	6	4.0L	w/Front Pipe; To 1/24/00	9100 ③	--
			w/Front Pipe; To 1/24/00	9102 ③④	2540③
97-99	6	4.0L	w/o Front Pipe, Additional sizing, bushings, cutting may be required due to OE exhaust design.	9150 ③	2540③
				--	--
93-95	6	4.0L		9716 ③	2905③
91-92	6	4.0L		4029 ③	6905③
87-90	6	4.2L		4469 ☆③	6004③
<b>KIA AMANTI</b>					
04-06	6	3.5L		4485 ③	2565R③○
07-09	6	3.8L	Manifold Unit, Front	1178 ③	--
07-09	6	3.8L	Rear Manifold Conv.	1179 ③	--
07-09	6	3.8L	Rear Main Conv.	4461 ③	2565R③○
<b>KIA FORTE</b>					
2013	4	2.0L	Auto Trans., California Emissions, w/o Center O2 Port, Rear	5132 ⑤	2565R⑤
10-12	4	2.0L	California Emissions, w/o Center O2 Port, Rear	5132 ⑤	2565R⑤
10-13	4	2.4L	California Emissions, w/o Center O2 Port, Rear	5132 ⑤	2565R⑤
10-12	4	2.4L	Federal Emissions, w/ Center O2 Port, Rear	4727 ④	--
<b>KIA FORTE KOUP</b>					
10-14	4	2.0L	California Emissions, w/o Center O2 Port, Rear	5132 ⑤	2565R⑤
10-13	4	2.4L	California Emissions, w/o Center O2 Port, Rear	5132 ⑤	2565R⑤
10-12	4	2.4L	Rear, Federal Emissions	4727 ④	--
<b>KIA OPTIMA</b>					
13-14	4	2.4L	Hybrid EX, Hybrid LX, Rear	5132 ⑤	2565R⑤
09-10	4	2.4L	Rear	4727 ③	--
07-08	4	2.4L	Front Conv.	1098 ③	--
07-08	4	2.4L	Rear Conv.	4348 ③	2574R③○
			Rear Conv.	--	2564R③□
2006	4	2.4L	Front, w/ Eng. VIN 6	1018 ③	--
2006	4	2.4L	Rear, w/ Eng. VIN 6	4358 ③	2505③
2006	4	2.4L	Front, w/ Eng. VIN 3	1098 ③	--
2006	4	2.4L	Rear, w/ Eng. VIN 3	4348 ③	2574R③○
			Rear, w/ Eng. VIN 3	--	2564R③□
01-05	4	2.4L	Front	1018 ③	--
01-05	4	2.4L	Rear	4358 ③	2505③
2001	6	2.5L	Front Manifold Conv., w/ Curved Outlet	1024 ③	--
2001	6	2.5L	Rear Manifold Conv., w/ Curved Outlet	1025 ③	--
07-08	6	2.7L	Manifold Unit, Front Left	1339 ③	--
2006	6	2.7L	Rear Manifold Conv., VIN 8 Only or With Curved Outlet	1025 ③	--
2006	6	2.7L	Front Manifold Conv., VIN 8 Only or With Curved Outlet	1024 ③	--

- ③ Discontinued, use until inventory is depleted.
- ☆ Air Tube kit 4948 may be required for installation.
- ③ Federal & California Emissions. Not For Sale or Use on vehicles licensed in the state of CA & NY (NY vehicles with CA Emissions). Check with your state authority for details.
- ④ Federal Emissions. Not For Sale or Use on vehicles licensed in the state of CA. Check with your state authority.
- ⑤ California Emissions. Not For Sale or Use on vehicles licensed in the state of CA & NY. Check with your state authority.
- EPA OBDII By Design Unit
- EPA Enhanced OBDII By Design Unit



YR/YRS	CYL	LITER	DESCRIPTION	DIRECT FIT	UNIVERSAL
<b>KIA OPTIMA (Cont.)</b>					
2006	6	2.7L	Eng. VIN 4, Manifold Unit, Front Left	1339 ③	--
02-05	6	2.7L	Front Manifold Conv., w/ Curved Outlet	1024 ③	--
02-05	6	2.7L	Rear Manifold Conv., w/ Curved Outlet	1025 ③	--
<b>KIA RIO</b>					
01-02	4	1.5L	Manifold Unit, Front	1188 ③	--
01-02	4	1.5L		4288 ③	2539③
12-14	4	1.6L	Rear Conv., Requires Resonator Pipe 58555 to Complete Installation, As OE was a One Piece Welded Assembly	4933 ③	2538③
06-11	4	1.6L	Rear Conv.	5001 ③	--
06-10	4	1.6L	Manifold Conv.	4611 ③	--
03-05	4	1.6L	Manifold Conv.	1035 ③	--
03-04	4	1.6L		--	2504③
<b>KIA RIO5</b>					
06-10	4	1.6L	Manifold Conv.	4611 ③	--
06-09	4	1.6L	Rear Conv.	5001 ③	--
<b>KIA RONDO</b>					
09-10	4	2.4L	Rear, From 10/08	4727 ③	2571R③
2009	4	2.4L	Rear, From 10/08	4500 ③⑩	2571R③○
07-09	4	2.4L	Rear, To 10/08	4348 ③	2574R③○
			Rear, To 10/08	--	2564R③□
2007	4	2.7L	Rear Main Conv.	4643 ③	--
07-10	6	2.7L	Manifold Unit, Front Left	1339 ③	--
<b>KIA SEDONA</b>					
02-05	6	3.5L	Front Manifold	1070 ③	--
02-05	6	3.5L	Rear Manifold	1089 ③	--
02-05	6	3.5L	Rear Main	4329 ③	2505③
06-10	6	3.8L	Rear Main Conv.	4726 ③	--
06-10	6	3.8L	Manifold Unit, Front	1178 ③	--
06-10	6	3.8L	Rear Manifold Conv.	1179 ③	--
<b>KIA SEPHIA</b>					
96-97	4	1.6L		--	2539③
1995	4	1.6L		--	2539③
1994	4	1.6L	SOHC	4377 ③	6904③
99-01	4	1.8L	Front, From 05/11/99	1146 ③	--
99-01	4	1.8L	Rear, From 05/11/99	4846 ③	2539③
98-99	4	1.8L	Front, To 05/11/99	1083 ③	--
98-99	4	1.8L	Rear, To 05/11/99	4813 ③	2504③
96-97	4	1.8L		--	2539③
1995	4	1.8L		--	2539③
<b>KIA SORENTO</b>					
11-13	4	2.4L	Rear	4710 ③	2574R③
08-09	6	3.3L	Rear Left	5129 ③	--
08-09	6	3.3L	Rear Right	5129 ③	--
03-06	6	3.5L	Front Left	1208 ③	--
03-06	6	3.5L	Rear Conv.	4408 ③	--
03-06	6	3.5L	Front Right	1208 ③	--
07-09	6	3.8L	Rear Left	5129 ③	--

⑩ Discontinued, use until inventory is depleted.

③ Federal & California Emissions. Not For Sale or Use on vehicles licensed in the state of CA & NY (NY vehicles with CA Emissions). Check with your state authority for details.

□ EPA OBDII By Design Unit

○ EPA Enhanced OBDII By Design Unit

# APPLICATION LISTINGS

## FEDERAL CONVERTERS



YR/YRS	CYL	LITER	DESCRIPTION	DIRECT FIT	UNIVERSAL
<b>KIA SORENTO (Cont.)</b>					
07-09	6	3.8L	Rear Right	5129 ③	--
<b>KIA SOUL</b>					
10-11	4	2.0L	Straight Outlet, Manifold Unit, Front	1234 ③	--
10-11	4	2.0L	Rear	5000 ③	--
<b>KIA SPECTRA</b>					
01-04	4	1.8L	Front, From 05/22/01	1186 ③	--
00-04	4	1.8L	w/Flat 2 Bolt Inlet Gasket, 13" OAL, Rear Conv.	4846 ③	2539③
00-01	4	1.8L	Front, To 05/22/01	1146 ③	--
08-09	4	2.0L	Front Manifold Conv., w/ Curved Outlet	1180 ③	--
07-09	4	2.0L	California Emissions, ULEV, 9-3/4" OAL, Rear	4428 ⑤	2564R⑤
07-09	4	2.0L	Federal Emissions, 10-1/4" OAL, Rear	4491 ④	--
04-09	4	2.0L	Straight Outlet, Manifold Unit, Front	1234 ③	--
			Straight Outlet, Manifold Unit, Front	1191 ④⑩	--
			Straight Outlet, Manifold Unit, Front	1108 ⑤⑩	--
04-07	4	2.0L	Auto. Trans., Federal Emissions, Before 7/12/07, 14 3/4" OAL, Rear Conv.	4808 ④	--
05-06	4	2.0L	13" OAL, Rear Conv.	4846 ③	2539③
05-06	4	2.0L	Rear Conv.	4846 ③	2539③
<b>KIA SPECTRA5</b>					
08-09	4	2.0L	Front Manifold Conv., w/ Curved Outlet	1180 ③	--
06-09	4	2.0L	Straight Outlet, Manifold Unit, Front	1234 ③	--
06-07	4	2.0L	Auto. Trans., Federal Emissions, 14 3/4" OAL, Rear Conv.	4808 ④	--
<b>KIA SPORTAGE</b>					
05-10	4	2.0L	Rear	4724 ③	--
05-08	4	2.0L	Manifold Conv.	1181 ③	--
01-02	4	2.0L	Front, Manual Trans.	1038 ③	--
01-02	4	2.0L	Rear, Manual Trans.	--	2504③
01-02	4	2.0L	Front, Auto Trans.	1009 ③	--
01-02	4	2.0L	Rear, Auto Trans.	4309 ③	2540③
98-00	4	2.0L	Front, First Design System (2 piece)	1038 ③	--
98-00	4	2.0L	Rear, First Design System (2 piece)	4847 ③	2539③
98-00	4	2.0L	Front, Second Design System (3 piece)	1077 ③	--
98-00	4	2.0L	Rear, Second Design System (3 piece)	4978 ③	2539③
96-97	4	2.0L	Main Conv.	--	2539③
1995	4	All	All, (Exc. 14-5/8" Conv.)	--	6904③
1995	4	All	All 14-5/8" Conv.	4889 ③	6904③
05-10	6	2.7L	Rear	4725 ③	--
05-10	6	2.7L	FWD, Right Manifold Conv.	1209 ③	--
05-10	6	2.7L	AWD, Manifold Unit, Front Right	1341 ③	--
<b>LADA SAMARA</b>					
87-93	4	All	Samara (Canada Model)	--	6904R③
<b>LANCIA BETA</b>					
1981	4	2.0L	Fuel Injection	--	6903③
1979	4	2.0L	California Emissions, w/Carb.	--	6903⑤
<b>LANCIA ZAGATO</b>					
81-82	4	2.0L	Fuel Injection	--	6903③
1979	4	2.0L	California Emissions, w/Carb.	--	6903⑤

⑩ Discontinued, use until inventory is depleted.

③ Federal & California Emissions. Not For Sale or Use on vehicles licensed in the state of CA & NY (NY vehicles with CA Emissions). Check with your state authority for details.

④ Federal Emissions. Not For Sale or Use on vehicles licensed in the state of CA. Check with your state authority.

⑤ California Emissions. Not For Sale or Use on vehicles licensed in the state of CA & NY. Check with your state authority.

YR/YRS	CYL	LITER	DESCRIPTION	DIRECT FIT	UNIVERSAL
<b>LAND ROVER DEFENDER 90</b>					
94-95	8	3.9L	Right	--	2540③
94-95	8	3.9L	Left	--	2540③
<b>LAND ROVER DEFENDER 110</b>					
1993	8	3.9L	Left	--	2904③
1993	8	3.9L	Right	--	2904③
<b>LAND ROVER DISCOVERY</b>					
94-95	8	3.9L	Right	--	2540③
94-95	8	3.9L	Left	--	2540③
99-02	8	4.0L		9709 ③	--
96-98	8	4.0L		9707 ③	--
03-04	8	4.6L		9709 ③	--
<b>LAND ROVER FREELANDER</b>					
02-05	6	2.5L	Front	9712 ③	--
02-05	6	2.5L	Rear	9713 ③	--
<b>LAND ROVER LR2</b>					
08-12	8	3.2L	Manifold Unit, Right	1319 ③	--
08-12	8	3.2L	Manifold Unit, Left	1320 ③	--
<b>LAND ROVER RANGE ROVER</b>					
90-94	8	3.9L	Left	--	2540③
90-94	8	3.9L	Right	--	2540③
99-00	8	4.0L	Center	9882 ③	--
1995	8	4.0L	Left	--	2539③
1995	8	4.0L	Right	--	2539③
2006	8	4.2L	Left	9538 ③	--
2006	8	4.2L	Right	9539 ③	--
94-95	8	4.2L	LWB, Left Side	--	2904③
94-95	8	4.2L	LWB, Right Side	--	2904③
2006	8	4.4L	Right	9539 ③	--
2006	8	4.4L	Left	9538 ③	--
99-02	8	4.6L	Center	9882 ③	--
<b>LEXUS ES250</b>					
90-91	6	2.5L		4377 ③	6904③
<b>LEXUS ES300</b>					
02-03	6	3.0L	Manifold Unit, Front	1170 ③	--
02-03	6	3.0L	Rear Manifold Conv.	1172 ③	--
02-03	6	3.0L	Rear Main	4383 ③	2574R③
99-01	6	3.0L	Front Manifold Conv., California Emissions	1076 ⑤	--
99-01	6	3.0L	Middle Conv., California Emissions	4476 ⑤	--
99-01	6	3.0L	Rear Conv.	4373 ③	2565R③
97-99	6	3.0L	Auto Trans., Federal Emissions	4835 ④	2538④
97-99	6	3.0L	Manual Trans. Federal Emissions	--	2538④
96-98	6	3.0L	Front Manifold Conv., California Emissions	1076 ⑤	--
96-98	6	3.0L	Main Conv., U.S. Built, Calif. Emissions	4259 ⑤	--
1995	6	3.0L		--	2538③
92-94	6	3.0L		4087 ③	6806③
<b>LEXUS ES330</b>					
04-06	6	3.3L	Rear Main, USA Built, Auto Trans.	4383 ③	2574R③○

③ Federal & California Emissions. Not For Sale or Use on vehicles licensed in the state of CA & NY (NY vehicles with CA Emissions). Check with your state authority for details.

④ Federal Emissions. Not For Sale or Use on vehicles licensed in the state of CA. Check with your state authority.

⑤ California Emissions. Not For Sale or Use on vehicles licensed in the state of CA & NY. Check with your state authority.

○ EPA Enhanced OBDII By Design Unit

**APPLICATION LISTINGS**  
**FEDERAL CONVERTERS**



YR/YRS	CYL	LITER	DESCRIPTION	DIRECT FIT	UNIVERSAL
<b>LEXUS ES330 (Cont.)</b>					
04-06	6	3.3L	Rear Manifold Conv.	1173 ③	--
04-06	6	3.3L	Manifold Unit, Front	1171 ③	--
<b>LEXUS ES350</b>					
07-11	6	3.5L	Manifold Unit, Front	1159 ③	--
07-11	6	3.5L	To 08/2010, Rear Manifold Conv.	1157 ③	--
<b>LEXUS GS300</b>					
00-05	6	3.0L	w/42" Conv., Rear	4440 ③	2538 ③
98-05	6	3.0L	Manifold Conv.	4276 ③	--
93-97	6	3.0L		4337 ③	2565 ③
93-94	6	3.0L	Front	4336 ③	--
<b>LEXUS GS400</b>					
98-00	8	4.0L	Left	4971 ③	--
98-00	8	4.0L	Right	4971 ③	--
<b>LEXUS GS430</b>					
01-07	8	4.3L	Left	4971 ③	--
01-07	8	4.3L	Right	4971 ③	--
01-05	8	4.3L	Rear	5142 ③	--
<b>LEXUS GX470</b>					
05-09	8	4.7L	Rear Right	4732 ③	2574R ③
05-09	8	4.7L	Rear Left	4917 ③	2574R ③
05-09	8	4.7L	From 11/2004, Front Left	1213 ③	--
05-09	8	4.7L	From 11/2004, Front Right	1214 ③	--
03-05	8	4.7L	Manifold Unit, Front Right	1336 ③	--
03-05	8	4.7L	Manifold Unit, Front Left	1335 ③	--
03-04	8	4.7L	Rear Main	4507 ③	2575R ③○
<b>LEXUS IS250</b>					
06-12	6	2.5L	Rear Complete Assembly, RWD	5004 ③	--
06-12	6	2.5L	AWD, Manifold Unit, Front Left	1300 ③	--
06-12	6	2.5L	AWD, Manifold Unit, Front Right	1301 ③	--
<b>LEXUS IS300</b>					
01-05	6	3.0L	Manifold Conv.	4276 ③	--
01-05	6	3.0L	w/42" Conv., Rear	4440 ③	2538 ③
<b>LEXUS IS350</b>					
06-12	6	3.5L	RWD, Rear	5064 ③	--
<b>LEXUS LS400</b>					
99-00	8	4.0L	Right	4272 ③	--
99-00	8	4.0L	Left	4273 ③	--
1998	8	4.0L	Right	5158 ③	--
1998	8	4.0L	Left	4971 ③	--
95-97	8	4.0L	Rear	5056 ③	--
90-97	8	4.0L	Left	4198 ③	6904R ③
90-97	8	4.0L	Right	4198 ③	6904R ③
90-94	8	4.0L	Rear	5187 ③	--
<b>LEXUS LS430</b>					
01-06	8	4.3L	Left	4971 ③	--
01-06	8	4.3L	Right	4971 ③	--
01-03	8	4.3L	Rear Main Conv.	4561 ③	--

③ Federal & California Emissions. Not For Sale or Use on vehicles licensed in the state of CA & NY (NY vehicles with CA Emissions). Check with your state authority for details.  
○ EPA Enhanced OBDII By Design Unit

YR/YRS	CYL	LITER	DESCRIPTION	DIRECT FIT	UNIVERSAL
<b>LEXUS LX450</b>					
96-97	6	4.5L	Rear	9238 ③	2904③
96-97	6	4.5L	Front	9978 ③	2576③
<b>LEXUS LX470</b>					
98-02	8	4.7L	Left	9537 ③	--
98-02	8	4.7L	Right	9537 ③	--
<b>LEXUS RX300</b>					
99-03	6	3.0L	Front	1032 ③	--
99-03	6	3.0L	Center	1033 ③	--
99-03	6	3.0L	Rear, OE exhaust system is completely welded, P/N 7511 resonator pipe is required for installation.	9232 ③①	--
			Rear, OE exhaust system is completely welded, P/N 7511 resonator pipe is required for installation.	5121 ③ <sup>1</sup>	2576R③
				--	--
<b>LEXUS RX330</b>					
04-06	6	3.3L	Manifold Unit, Front	1114 ③	--
04-06	6	3.3L	Rear Manifold Conv.	1119 ③	--
04-06	6	3.3L	Main Conv., Due to O.E. design, #8 bushing or sizing with aftermarket pipe may be required	9224 ③	--
				--	--
<b>LEXUS RX350</b>					
07-09	6	3.5L	Manifold Unit, Front	1165 ③	--
07-09	6	3.5L	Rear Manifold Conv.	1166 ③	--
07-09	6	3.5L	Rear, Requires Welded Assembly 7505 to complete installation as OE is complete welded assembly	9419 ③	--
				--	--
<b>LEXUS RX400H</b>					
06-08	6	3.3L	Rear, Requires Welded Assembly 7885 to Complete Installation	4004 ③	2574R③
06-08	6	3.3L	Manifold Unit, Front Right	1296 ③	--
<b>LEXUS SC300</b>					
98-00	6	3.0L	Manifold Conv.	4276 ③	--
93-97	6	3.0L		4337 ③	2565③
93-94	6	3.0L	Front	4336 ③	--
<b>LEXUS SC400</b>					
92-97	8	4.0L	Left	4198 ③	--
92-97	8	4.0L	Right	4345 ③	--
92-97	8	4.0L	Rear	5187 ③	--
<b>LEXUS SC430</b>					
02-10	8	4.3L	Rear	5146 ③	--
02-09	8	4.3L	Left	4971 ③	--
02-09	8	4.3L	Right	4971 ③	--
<b>LINCOLN AVIATOR</b>					
03-05	8	4.6L	Rear Conv.	--	2516③
03-05	8	4.6L	Front Left	--	2565R③
03-05	8	4.6L	Front Right	--	2565R③
<b>LINCOLN CONTINENTAL</b>					
90-94	6	3.8L	From 12/89, Left	--	6904③
90-94	6	3.8L	Complete, From 12/89	4118 ③	6904③
90-94	6	3.8L	From 12/89, Right	--	6904③
88-90	6	3.8L	Rear, To 12/89	--	6904③
88-90	6	3.8L	Main & Pre-Cat, To 12/89	--	6904③
1982	6	3.8L	Rear	--	6005③

<sup>1</sup> OE system was a welded assembly. It is recommended that all parts noted [1] should be replaced.

③ Discontinued, use until inventory is depleted.

③ Federal & California Emissions. Not For Sale or Use on vehicles licensed in the state of CA & NY (NY vehicles with CA Emissions). Check with your state authority for details.

**APPLICATION LISTINGS  
FEDERAL CONVERTERS**



YR/YRS	CYL	LITER	DESCRIPTION	DIRECT FIT	UNIVERSAL
<b>LINCOLN CONTINENTAL (Cont.)</b>					
1982	6	3.8L	Main & Pre-Cat	--	6005③
95-02	8	4.6L	Front	4810 ③	--
95-02	8	4.6L		4811 ③	--
1987	8	5.0L	California Emissions, Models w/Dual Exhaust, Rear Left	--	6575I⑤
1987	8	5.0L	California Emissions, Models w/Dual Exhaust, Front Right	--	6575I⑤
1987	8	5.0L	California Emissions, Models w/Dual Exhaust, Front Left	--	6575I⑤
1987	8	5.0L	California Emissions, Models w/Dual Exhaust, Rear Right	--	6575I⑤
85-87	8	5.0L	Rear, (Exc. Dual Exhaust)	--	6005③
85-87	8	5.0L	(Exc. Dual Exhaust), Main & Pre-Cat	--	6005③
85-87	8	5.0L	w/Dual Exhaust, Front Left	--	6905③
85-87	8	5.0L	w/Dual Exhaust, Rear Left	--	2905③
85-87	8	5.0L	w/Dual Exhaust, Front Right	--	6905③
85-87	8	5.0L	w/Dual Exhaust, Rear Right	--	2905③
83-84	8	5.0L	Left	--	6005③
83-84	8	5.0L	Right	--	6005③
1982	8	5.0L		--	6005③
1980	8	5.0L	Left	--	6904R③
1980	8	5.0L	Right	--	6904R③
1980	8	5.8L	Left	--	6904R③
1980	8	5.8L	Right	--	6904R③
<b>LINCOLN LS</b>					
02-05	6	3.0L	Right	4420 ③	2554③
02-05	6	3.0L	Left	4421 ③	2554③
00-01	6	3.0L	Right, Auto Trans.	4420 ③	2554③
00-01	6	3.0L	Left, Auto Trans.	4421 ③	2554③
2004	8	3.9L	Complete Assembly, 07/03 to 07/04	4247 ③	--
2004	8	3.9L	Front Left, 07/03 to 07/04	--	2575③○
			Front Left, 07/03 to 07/04	--	2504③□
2004	8	3.9L	Front Right, 07/03 to 07/04	--	2575③○
			Front Right, 07/03 to 07/04	--	2504③□
2003	8	3.9L	Complete Assembly	4653 ③	--
00-01	8	3.9L	Right; To 7/16/01	4218 ③	2504③
00-01	8	3.9L	Left; To 7/16/01	4219 ③	2504③
<b>LINCOLN MARK LT</b>					
06-08	8	5.4L	2WD, Right	9256 ③	2571R③
06-08	8	5.4L	2WD, Left	9257 ③	2571R③
06-08	8	5.4L	4WD, Right	9268 ③	2571R③
06-08	8	5.4L	4WD, Left	9269 ③	2571R③
2006	8	5.4L	4WD, w/ 2 Converters, California Emissions, Base Payload, To 8/8/05, Left	9468 ⑤	--
				--	--
2006	8	5.4L	4WD, w/ 2 Converters, California Emissions, Base Payload, To 8/8/05, Right	9469 ⑤	--
				--	--
<b>LINCOLN MARK Series</b>					
97-98	8	4.6L	Mark "8", Left Conv. w/Manifold	9204 ③	--
97-98	8	4.6L	Mark "8", Right Conv. w/Single Inlet Muffler	9704 ③	--
97-98	8	4.6L	Mark "8", Right Conv. w/Dual Inlet Muffler	4704 ③	--
95-96	8	4.6L	Mark "8", Left Conv. w/Manifold	9604 ③	--

- ③ Federal & California Emissions. Not For Sale or Use on vehicles licensed in the state of CA & NY (NY vehicles with CA Emissions). Check with your state authority for details.
- ⑤ California Emissions. Not For Sale or Use on vehicles licensed in the state of CA & NY. Check with your state authority.
- EPA OBDII By Design Unit
- EPA Enhanced OBDII By Design Unit

YR/YRS	CYL	LITER	DESCRIPTION	DIRECT FIT	UNIVERSAL
<b>LINCOLN MARK Series (Cont.)</b>					
95-96	8	4.6L	Mark "8", Right Conv. w/Single Inlet Muffler	9704 ③	--
95-96	8	4.6L	Mark "8", Right Conv. w/Dual Inlet Muffler	4704 ③	--
93-94	8	4.6L	Mark "8", Left Conv. w/Manifold	9604 ③	--
93-94	8	4.6L	Mark "8", Right Conv. w/Single Inlet Muffler	9704 ③	--
93-94	8	4.6L	Mark "8", Right Conv. w/Dual Inlet Muffler	4704 ③	--
88-92	8	5.0L	w/Dual Exhaust, Left	--	6905 ③
88-92	8	5.0L	Complete, Dual Exhaust	--	2905 ③
88-92	8	5.0L	w/Dual Exhaust, Right	--	6905 ③
87-91	8	5.0L	California Emissions, Exc. 1989, Rear Left	--	6575I ⑤
87-91	8	5.0L	California Emissions, Exc. 1989, Front Right	--	6575I ⑤
87-91	8	5.0L	California Emissions, Exc. 1989, Front Left	--	6575I ⑤
87-91	8	5.0L	California Emissions, Exc. 1989, Rear Right	--	6575I ⑤
86-87	8	5.0L	Rear	--	6005 ③
86-87	8	5.0L	Main & Pre-Cat	--	6005 ③
84-85	8	5.0L	Left	--	6005 ③
84-85	8	5.0L	Right	--	6005 ③
82-83	8	5.0L	Left	--	6004 ③
82-83	8	5.0L	Right	--	6004 ③
1981	8	5.0L	Left, (Exc. Dual Exhaust)	--	6004 ③
1981	8	5.0L	Right, (Exc. Dual Exhaust)	--	6004 ③
80-81	8	5.0L	w/Dual Exhaust, Rear Left	--	6004 ③
80-81	8	5.0L	w/Dual Exhaust, Rear Right	--	6004 ③
80-81	8	5.0L	w/Dual Exhaust, Front Right	--	6004 ③
80-81	8	5.0L	w/Dual Exhaust, Front Left	--	6004 ③
77-79	8	6.6L	Left	--	9004 ③
77-79	8	6.6L	Right	--	9004 ③
75-76	8	7.5L	Left	--	9004 ③
75-76	8	7.5L	Right	--	9004 ③
<b>LINCOLN MKS</b>					
09-10	6	3.7L	Front Conv.	4454 ③	--
09-10	6	3.7L	Rear Conv.	4455 ③	--
<b>LINCOLN MKX</b>					
07-10	6	3.5L	Front Conv.	4454 ③	--
07-10	6	3.5L	Rear Conv.	4455 ③	--
11-14	6	3.7L	Manifold Unit, Front Left	1285 ③	--
11-14	6	3.7L	Manifold Unit, Front Right	1286 ③	--
<b>LINCOLN MKZ</b>					
07-10	6	3.5L	Front Conv.	4454 ③	--
07-10	6	3.5L	Rear Conv.	4455 ③	--
<b>LINCOLN NAVIGATOR</b>					
07-14	8	5.4L	Left	9984 ③	--
07-14	8	5.4L	Right	9985 ③	--
05-06	8	5.4L	Left	9905 ③	2578R ③
05-06	8	5.4L	Right	9906 ③	2578R ③
03-04	8	5.4L	Left	9982 ③	--
03-04	8	5.4L	Right	9983 ③	--
01-02	8	5.4L	Right, 4WD	9250 ③	--

③ Federal & California Emissions. Not For Sale or Use on vehicles licensed in the state of CA & NY (NY vehicles with CA Emissions). Check with your state authority for details.

⑤ California Emissions. Not For Sale or Use on vehicles licensed in the state of CA & NY. Check with your state authority.

**APPLICATION LISTINGS  
FEDERAL CONVERTERS**



YR/YRS	CYL	LITER	DESCRIPTION	DIRECT FIT	UNIVERSAL
<b>LINCOLN NAVIGATOR (Cont.)</b>					
01-02	8	5.4L	Left, 4WD	9251 ③	--
01-02	8	5.4L	Front Left, 4WD	--	2538③
01-02	8	5.4L	Rear Left, 4WD	--	2506③
01-02	8	5.4L	Front Right, 4WD	--	2538③
01-02	8	5.4L	Rear Right, 4WD	--	2506③
98-00	8	5.4L	Front Left	--	2545③
98-00	8	5.4L	Rear Left	--	2540③
98-00	8	5.4L	Complete Right Assembly, 4WD, 4R100 Trans.	9050 ③	--
98-00	8	5.4L	Complete Left Assembly, 4WD, 4R100 Trans.	9051 ③	--
98-00	8	5.4L	Front Right	--	2545③
98-00	8	5.4L	Rear Right	--	2540③
<b>LINCOLN TOWN CAR</b>					
03-11	8	4.6L	Front Left	--	2554③
03-11	8	4.6L	Rear Left	--	2564③
03-11	8	4.6L	Right	4803 ③	--
03-11	8	4.6L	Left	5002 ③	--
03-11	8	4.6L	Front Right	--	2554③
03-11	8	4.6L	Rear Right	--	2564③
03-06	8	4.6L	Right	4270 ③⑩	--
03-06	8	4.6L	Left	4271 ③⑩	--
96-02	8	4.6L	Right	4871 ③	--
96-02	8	4.6L	Left	4870 ③	--
96-02	8	4.6L	Rear Left	--	2504③
96-02	8	4.6L	Rear Right	--	2504③
96-02	8	4.6L	Front Left	--	2538③
96-02	8	4.6L	Front Right	--	2538③
1995	8	4.6L	Right	4599 ③	2504③
1995	8	4.6L	Left	4598 ③	2504③
91-94	8	4.6L	Right, Main & Pre-Cat	4520 ③	6904③
91-94	8	4.6L	Left, Main & Pre-Cat	4521 ③	6904③
1990	8	5.0L	Right Side, Main & Pre-Cat	4244 ☆③	6004③
1990	8	5.0L	Left, Main & Pre-Cat	4245 ☆③	6004③
1990	8	5.0L	California Emissions, Right Side, Main & Pre-Cat	--	6574I⑤
1990	8	5.0L	California Emissions, Left Side, Main & Pre-Cat	--	6574I⑤
1989	8	5.0L	Right Side, Main & Pre-Cat	4244 ☆③	6004③
1989	8	5.0L	Left, Main & Pre-Cat	4245 ☆③	6004③
86-88	8	5.0L	Right Side	4244 ☆③	6004③
86-88	8	5.0L	Left Side	4245 ☆③	6004③
86-88	8	5.0L	California Emissions, Right Side, Main & Pre-Cat	--	6574I⑤
86-88	8	5.0L	California Emissions, Left Side, Main & Pre-Cat	--	6574I⑤
81-85	8	5.0L	Right Side	--	6004③
81-85	8	5.0L	Left	--	6004③
<b>LINCOLN VERSAILLES</b>					
1980	8	5.0L		--	6905③
1980	8	5.0L	Main & Pre-Cat	--	6005③
77-79	8	5.0L	18" Conv.	--	6905③
77-79	8	5.0L	(Exc. 18" Conv.)	--	6905③

- Ⓞ Discontinued, use until inventory is depleted.
- ☆ Air Tube kit 4948 may be required for installation.
- ③ Federal & California Emissions. Not For Sale or Use on vehicles licensed in the state of CA & NY (NY vehicles with CA Emissions). Check with your state authority for details.
- ⑩ California Emissions. Not For Sale or Use on vehicles licensed in the state of CA & NY. Check with your state authority.



YR/YRS	CYL	LITER	DESCRIPTION	DIRECT FIT	UNIVERSAL
<b>LINCOLN ZEPHYR</b>					
2006	6	3.0L	Rear Manifold Conv.	1123 ③	--
2006	6	3.0L	Manifold Unit, Front Left	1211 ③	--
			Manifold Unit, Front Left	1122 ③④	--
2006	6	3.0L	Rear Main Conv.	4453 ③	2505 ③
<b>LOTUS ELAN</b>					
1991	4	All	Elan	--	6904 ③
<b>LOTUS ESPRIT</b>					
90-94	4	2.2L	Esprit	--	6904 ③
79-89	4	All	Esprit	--	6903 ③
<b>MASERATI BITURBO</b>					
85-87	6	2.5L		--	8006 ③
<b>MASERATI BORA</b>					
80-82	8	4.9L		--	8006 ③
<b>MASERATI QUATTROPORTE</b>					
80-82	8	4.9L		--	8006 ③
<b>MAZDA 3</b>					
10-12	4	2.0L	Rear Conv., For use with Aftermarket Pipe 58553	4930 ③	2538 ③
07-09	4	2.0L	Manifold Conv., Federal Emissions	4562 ④	--
07-09	4	2.0L	Rear Conv., For use with Aftermarket Pipe	4747 ④	2515 ③
07-09	4	2.0L	Rear Conv., For use with OE pipe, additional sizing, bushings, cutting may be required due to OE exhaust design.	4563 <sup>900</sup> ④	2515 ③
				--	--
04-06	4	2.0L	California Emissions, Manifold Unit, Front	1303 ⑤	--
04-06	4	2.0L	Federal Emissions, Manifold Unit, Front	1307 ④	--
2009	4	2.3L	Sedan, Exc. Turbo, Rear Conv., For use with Aftermarket Pipe	4747 ④	2515 ③
07-09	4	2.3L	Rear Conv., For use with OE pipe, additional sizing, bushings, cutting may be required due to OE exhaust design.	4563 <sup>900</sup> ④	2515 ③
				--	--
06-09	4	2.3L	Federal Emissions, Manifold Unit, Front	1302 ④	--
07-08	4	2.3L	Exc. Turbo, Rear Conv., For use with Aftermarket Pipe	4747 ④	2515 ③
<b>MAZDA 3 SPORT</b>					
2012	4	2.5L	Rear Conv., For use with Aftermarket Pipe 58553	4930 ③	2538 ③
<b>MAZDA 323</b>					
90-94	4	1.6L		--	6904 ③
88-89	4	1.6L	Turbo	4408 ③	6905 ③
86-89	4	1.6L	(Exc. Turbo), Reversible/Non-Directional Unit	--	6904 ③
<b>MAZDA 5</b>					
08-10	4	2.3L	Manifold Unit, Front	1302 ③	--
<b>MAZDA 6</b>					
2008	4	2.3L	Federal Emissions	4434 ④	2572R ④○
06-07	4	2.3L	Naturally Aspirated, Manual Trans., Calif. Emissions	4434 ⑤	2572R ⑤○
06-07	4	2.3L	Naturally Aspirated, Federal Emissions	4434 ④	2572R ④○
05-06	4	2.3L	Naturally Aspirated, California Emissions, Manifold Unit, Front	1305 ⑤	--
03-05	4	2.3L	Federal Emissions	4434 ④	2572R ④○
09-13	4	2.5L	Rear	5106 ③	--
06-08	6	3.0L	Manifold Unit, Front	1600 ③	--
06-08	6	3.0L	Rear Manifold Conv.	1601 ③	--
06-08	6	3.0L	Rear Main Conv.	4600 ③	--
03-05	6	3.0L	Manifold Unit, Front	1184 ③	--

③ Discontinued, use until inventory is depleted.

<sup>900</sup> Direct fit converter may require resizing, cutting or bushing.

③ Federal & California Emissions. Not For Sale or Use on vehicles licensed in the state of CA & NY (NY vehicles with CA Emissions). Check with your state authority for details.

④ Federal Emissions. Not For Sale or Use on vehicles licensed in the state of CA. Check with your state authority.

⑤ California Emissions. Not For Sale or Use on vehicles licensed in the state of CA & NY. Check with your state authority.

○ EPA Enhanced OBDII By Design Unit

# APPLICATION LISTINGS

## FEDERAL CONVERTERS



YR/YRS	CYL	LITER	DESCRIPTION	DIRECT FIT	UNIVERSAL
<b>MAZDA 6 (Cont.)</b>					
03-05	6	3.0L	Rear Manifold Conv.	1185 ③	--
03-05	6	3.0L	Front Main Conv.	4384 ③	2564③
03-05	6	3.0L	Rear Main Conv.	4385 ③	2564R③
09-13	6	3.7L	Front Right	1290 ③	--
<b>MAZDA 626</b>					
00-02	4	2.0L	Front, California Emissions	1034 ⑤	--
00-02	4	2.0L	Rear, California Emissions	4450 ⑤	2504⑤
98-02	4	2.0L	Rear, Federal Emissions	4451 ④	2505④
98-99	4	2.0L	Front, California Emissions, Includes Head Pipe	1050 ⑤	--
98-99	4	2.0L	Rear, California Emissions	4450 ⑤	2504⑤
96-97	4	2.0L	Front, Includes Head Pipe	4038 ③	--
96-97	4	2.0L		4701 ③	2539③
93-95	4	2.0L		4408 ③	6905③
86-87	4	2.0L	Rear, Turbo, w/Female Flare Inlet, Reversible/Non-Directional Unit	--	6904③
83-87	4	2.0L	Rear, (Exc. Turbo), w/Female Flare Inlet, Reversible/Non-Directional Unit	--	6904③
80-81	4	2.0L		4377 ③	6904③
90-92	4	2.2L	(Exc. Turbo), Reversible/Non-Directional Unit	4701 ③	6904③
88-91	4	2.2L	Rear, Turbo	--	6905③
88-89	4	2.2L	Manual Trans., (Exc. Turbo)	--	6904③
88-89	4	2.2L	Auto Trans., (Exc. Turbo, Reversible/Non-Directional Unit)	4701 ③	6904③
01-02	6	2.5L	Rear Manifold, w/ Auto. Trans.	1217 ③	--
98-02	6	2.5L	Rear, Federal Emissions	4451 ④	2505④
96-97	6	2.5L		--	2539③
93-95	6	2.5L		4540 ③	6904③
<b>MAZDA 929</b>					
92-95	6	3.0L	Front Right	1071 ③	--
92-95	6	3.0L	Front Left	1072 ③	--
92-95	6	3.0L		--	6905③
90-91	6	3.0L	DOHC, Left	4377 ③	6904③
90-91	6	3.0L	DOHC, Right	4377 ③	6904③
88-91	6	3.0L	SOHC	4408 ③	6905③
<b>MAZDA B-Series PICKUP</b>					
86-87	4	2.0L	Rear	4377 ③	6904③
86-87	4	2.0L	Main & Pre-Cat	--	6004③
79-84	4	2.0L		4377 ③	6904③
90-93	4	2.2L	Rear, w/o Air Tube	4377 ③	6904③
90-93	4	2.2L	Rear, w/ Air Tube	--	6004③
87-89	4	2.2L		4377 ③	6904③
87-89	4	2.2L	Main & Pre-Cat	--	6004③
07-09	4	2.3L		9255 ③	--
01-06	4	2.3L	DF Conv., Front & Rear	9174 ③	--
01-06	4	2.3L	Front Universal	--	2565③○
01-06	4	2.3L	Rear Universal	--	2505③
96-97	4	2.3L		4856 ③	2540③
1995	4	2.3L		4856 ③	2540③
1994	4	2.3L		4627 ③	6905③

- ③ Federal & California Emissions. Not For Sale or Use on vehicles licensed in the state of CA & NY (NY vehicles with CA Emissions). Check with your state authority for details.
- ④ Federal Emissions. Not For Sale or Use on vehicles licensed in the state of CA. Check with your state authority.
- ⑤ California Emissions. Not For Sale or Use on vehicles licensed in the state of CA & NY. Check with your state authority.
- EPA Enhanced OBDII By Design Unit

YR/YRS	CYL	LITER	DESCRIPTION	DIRECT FIT	UNIVERSAL
<b>MAZDA B-Series PICKUP (Cont.)</b>					
98-01	4	2.5L		9086 ③	2516③
90-93	4	2.6L		--	2904③
87-89	4	2.6L	4WD, Middle	--	6905③
87-89	4	2.6L	4WD, Rear	4377 ③	6904③
87-89	4	2.6L	Main & Pre-Cat	--	6004③
77-78	4	All		--	6904③
04-06	6	3.0L	Front Conv.	1105 ③	--
04-06	6	3.0L	Rear Conv.	9225 ③	--
01-03	6	3.0L	Rear Conv.	9144 ③	--
98-00	6	3.0L	With 2 Converters, California Emissions, Front	4650 ⑤	--
98-99	6	3.0L	Front	--	2516③
98-99	6	3.0L		--	2516③
98-99	6	3.0L	Complete Assembly	9314 ③	--
96-97	6	3.0L	Front	--	2516③
96-97	6	3.0L		--	2516③
96-97	6	3.0L	Complete Assembly	4816 ③	--
94-95	6	3.0L	Front	--	2905③
94-95	6	3.0L		--	2905③
94-95	6	3.0L	Complete Assembly, OEM Y-Pipe must be trimmed 1/2" from face of flange for proper insertion into converter.	9522 ③	--
				--	--
04-06	6	4.0L	Rear	9225 ③	--
01-03	6	4.0L	Front	1044 ③	--
01-03	6	4.0L		9144 ③	--
98-99	6	4.0L	Front	--	2516③
98-99	6	4.0L		--	2516③
98-99	6	4.0L	Complete Assembly	9314 ③	--
96-97	6	4.0L	Front	--	2516③
96-97	6	4.0L		--	2516③
96-97	6	4.0L	Complete Assembly	4816 ③	--
94-95	6	4.0L	Front	--	2905③
94-95	6	4.0L		--	2905③
94-95	6	4.0L	Complete Assembly, OEM Y-Pipe must be trimmed 1/2" from face of flange for proper insertion into converter.	9522 ③	--
				--	--
<b>MAZDA CX-7</b>					
07-09	4	2.3L	Front, Federal Emissions, Up To 01/01/09	4544 ④	--
07-09	4	2.3L	Rear, Federal Emissions, Includes Resonator	4545 ④	--
11-12	4	2.5L	Touring, Front	5118 ③	--
10-12	4	2.5L	Sport & SV, Front	5118 ③	--
<b>MAZDA CX-9</b>					
2007	6	3.5L	Front Right	1290 ③	--
08-15	6	3.7L	Front Right	1290 ③	--
<b>MAZDA GLC</b>					
77-78	4	1.3L	14" Conv.	--	6903③
77-78	4	1.3L	(Exc. 14" Conv.)	--	6904③
79-80	4	1.4L	14" Conv.	--	6903③
79-80	4	1.4L	(Exc. 14" Conv.)	--	6904③
83-85	4	1.5L	Sedan or Hatchback, Rear	--	6904③

③ Federal & California Emissions. Not For Sale or Use on vehicles licensed in the state of CA & NY (NY vehicles with CA Emissions). Check with your state authority for details.

④ Federal Emissions. Not For Sale or Use on vehicles licensed in the state of CA. Check with your state authority.

⑤ California Emissions. Not For Sale or Use on vehicles licensed in the state of CA & NY. Check with your state authority.

**APPLICATION LISTINGS**  
**FEDERAL CONVERTERS**



YR/YRS	CYL	LITER	DESCRIPTION	DIRECT FIT	UNIVERSAL
<b>MAZDA GLC (Cont.)</b>					
1983	4	1.5L	Station Wagon, Rear	--	6804③
81-82	4	1.5L	Rear	--	6804③
<b>MAZDA MIATA, MX5</b>					
90-93	4	1.6L		4529 ③	6904③
99-02	4	1.8L		4063 ③	2505R③
99-00	4	1.8L	Front, California Emissions	1189 ⑤	--
96-99	4	1.8L		--	2505③
1994	4	1.8L		--	6004③
2008	4	2.0L	Front, Manual Trans.	1153 ③	--
06-07	4	2.0L	Front Conv.	1153 ③	--
2006	4	2.0L	Rear Conv.	4553 ③	--
<b>MAZDA MILLENIA</b>					
96-02	6	2.3L	Rear Main Conv.	4056 ③	2514③
95-02	6	2.3L	Manifold Unit, Front	1056 ③	--
95-02	6	2.3L	Rear Manifold Conv.	1055 ③	--
1995	6	2.3L		--	2504③
97-02	6	2.5L		--	2564R③○
97-01	6	2.5L	Manifold Unit, Front	1218 ③	--
97-01	6	2.5L	Rear Manifold Conv.	1219 ③	--
1996	6	2.5L		9904 ③	2564R③
1995	6	2.5L		--	2504③
<b>MAZDA MPV VAN</b>					
89-94	4	2.6L		4377 ③	6904③
00-01	6	2.5L	Manifold Unit, Front	1026 ③	--
00-01	6	2.5L	Rear Manifold Conv.	1027 ③	--
00-01	6	2.5L	Rear	4505 ③	--
02-06	6	3.0L	Manifold Unit, Front	1080 ③	--
02-06	6	3.0L	Rear Manifold Conv.	1081 ③	--
02-06	6	3.0L	Right Rear Main Conv.	4380 ③	--
02-06	6	3.0L	Left Rear Main Conv.	4381 ③	2565R③○
96-98	6	3.0L	Front	--	2504R③
96-98	6	3.0L		--	2504③
96-97	6	3.0L	2WD, Front	4054 ③	--
94-95	6	3.0L	Front	--	6904R③
94-95	6	3.0L		--	6904③
89-93	6	3.0L		4377 ③	6904③
<b>MAZDA MX3</b>					
1995	4	1.6L	Rear Main Conv.	--	6904③
92-94	4	1.6L		--	6904③
92-93	6	All		--	6004③
<b>MAZDA MX6</b>					
96-97	4	2.0L	Front, Includes Head Pipe	4038 ③	--
96-97	4	2.0L		4701 ③	2539③
93-95	4	2.0L		4408 ③	6904③
89-92	4	2.2L	Manual Trans., (Exc. Turbo)	--	6904③
88-92	4	2.2L	Auto Trans., (Exc. Turbo, Reversible/Non-Directional Unit)	4701 ③	6904③
96-97	6	2.5L	Main Conv.	--	2539③

- ③ Federal & California Emissions. Not For Sale or Use on vehicles licensed in the state of CA & NY (NY vehicles with CA Emissions). Check with your state authority for details.
- ⑤ California Emissions. Not For Sale or Use on vehicles licensed in the state of CA & NY. Check with your state authority.
- EPA Enhanced OBDII By Design Unit

YR/YRS	CYL	LITER	DESCRIPTION	DIRECT FIT	UNIVERSAL
<b>MAZDA MX6 (Cont.)</b>					
93-95	6	2.5L		4540 ③	6905③
<b>MAZDA NAVAJO</b>					
91-94	6	4.0L	Front	--	2905③
91-94	6	4.0L		--	2905③
91-94	6	4.0L	Complete Assembly, OEM Y-Pipe must be trimmed 1/2" from face of flange for proper insertion into converter.	9522 ③	--
<b>MAZDA PROTÉGÉ</b>					
97-98	4	1.5L		4820 ③	2504R③
95-98	4	1.5L	Front, Includes Pipe Between Converters	1088 ③	--
95-96	4	1.5L		--	2504R③
99-01	4	1.6L	Front	1023 ③	--
99-00	4	1.8L	Front	1023 ③	--
99-00	4	1.8L	California Emissions, Rear	5159 ⑤	--
95-97	4	1.8L		--	2504③
90-94	4	1.8L		4530 ③	6904③
90-92	4	1.8L	4WD	--	6904③
01-03	4	2.0L	Front	1023 ③	--
01-03	4	2.0L	Rear	4349 ③	2504R③
<b>MAZDA RX-7</b>					
84-85	Rotary	1.1L		--	6004③
84-85	Rotary	1.1L	Main & Pre-Cat	--	6004③
81-83	Rotary	1.1L		--	6004③
81-83	Rotary	1.1L	Main & Pre-Cat	--	6004③
1980	Rotary	1.1L		--	6004③
86-91	Rotary	1.3L	Front, (Exc. Turbo)	--	6804③
86-91	Rotary	1.3L	Intermediate Conv., (Exc. Turbo)	--	6905③
86-91	Rotary	1.3L	Rear, (Exc. Turbo)	--	6005③
86-90	Rotary	1.3L	Rear, Turbo	--	6005③
86-90	Rotary	1.3L	Turbo, Main & Pre-Cat	--	6005③
84-85	Rotary	1.3L		--	6004③
84-85	Rotary	1.3L	Main & Pre-Cat	--	6004③
<b>MAZDA RX-8</b>					
04-08	R2	1.3L	Manual Trans.	4564 ③	--
04-06	R2	1.3L	To 2/14/06, Auto Trans.	4564 ③	--
<b>MAZDA TRIBUTE</b>					
2008	4	2.3L	Rear Main	9408 ③	--
2008	4	2.3L	Front Manifold Conv., i Submodel, Exc. Hybrid	1136 ③	--
2006	4	2.3L	Front Manifold Conv., From 10/03/05	1136 ③	--
05-06	4	2.3L	Rear Main	9408 ③	--
09-11	4	2.5L	i, GX; Exc. Hybrid; Requires Welded Assembly 60005 to Complete Assembly	9981 ③	--
09-11	6	3.0L	Manifold Unit, Front Left	1288 ③	--
09-11	6	3.0L	Manifold Unit, Front Right	1289 ③	--
2008	6	3.0L	Manifold Unit, Front Left	1283 ③	--
05-06	6	3.0L	Rear Main	9408 ③	--
01-06	6	3.0L	Manifold Unit, Front	1148 ③	--
01-06	6	3.0L	Rear Manifold Conv.	1147 ③	--

③ Federal & California Emissions. Not For Sale or Use on vehicles licensed in the state of CA & NY (NY vehicles with CA Emissions). Check with your state authority for details.

⑤ California Emissions. Not For Sale or Use on vehicles licensed in the state of CA & NY. Check with your state authority.

**APPLICATION LISTINGS**  
**FEDERAL CONVERTERS**



YR/YRS	CYL	LITER	DESCRIPTION	DIRECT FIT	UNIVERSAL
<b>MAZDA TRIBUTE (Cont.)</b>					
01-04	6	3.0L	Rear Main	9008 ③	2504 ③
<b>MERCEDES-BENZ 190</b>					
91-93	4	2.3L		--	2905 ③
86-88	4	2.3L	(Exc. 16 valve)	--	2904 ③
86-87	4	2.3L	16 valve	--	2904 ③
84-85	4	2.3L	Single Flange Inlet	--	2904 ③
84-85	4	2.3L	Dual Inlets	--	2904 ③
87-90	6	2.6L		--	2910 ③
<b>MERCEDES-BENZ 260</b>					
87-89	6	2.6L	260E	9717 ③	2910 ③
<b>MERCEDES-BENZ 280</b>					
78-79	6	2.8L	280CE, to Chassis # 016970	--	8015 ③
77-79	6	2.8L	280E, to Chassis # 063890	--	8015 ③
77-78	6	2.8L	280SE, to Chassis # 150379	--	8015 ③
<b>MERCEDES-BENZ 300</b>					
90-93	6	3.0L	300SL	--	2910 ③
88-93	6	3.0L	300TE	9717 ③	2910 ③
90-92	6	3.0L	300CE	--	2912 ③
88-91	6	3.0L	300SE / SEL	--	2912 ③
88-89	6	3.0L	300CE	9717 ③	2910 ③
86-89	6	3.0L	300E	9717 ③	2910 ③
<b>MERCEDES-BENZ 380</b>					
84-85	8	3.8L	SE, Single Cat System	--	9004 ③
81-85	8	3.8L	SL	--	2910 ③
81-83	8	3.8L	SEC / SEL, Single Cat System	--	9004 ③
1981	8	3.8L	SLC	--	2910 ③
<b>MERCEDES-BENZ 400</b>					
1993	8	4.2L	400SEL Models w/140 Chassis	9149 ③	--
1992	8	4.2L	400SE Models w/140 Chassis	9149 ③	--
<b>MERCEDES-BENZ 420</b>					
86-91	8	4.2L	420SEL	--	2910 ③
<b>MERCEDES-BENZ 450</b>					
77-80	8	4.5L	SEL, Left	--	9004 ③
77-80	8	4.5L	SEL, Right	--	9004 ③
77-79	8	4.5L	SL	--	8015 ③
<b>MERCEDES-BENZ 500</b>					
92-93	8	5.0L	500SEL & 500SEC w/140 Chassis	9149 ③	--
84-85	8	5.0L	500 Sedan / Coupe, SEL / SEC	--	9004 ③
<b>MERCEDES-BENZ C220</b>					
94-96	4	2.2L	111.944 Eng., Single Inlet Pipe	9219 ③	--
<b>MERCEDES-BENZ C230</b>					
1997	4	2.3L	111.944 Eng., Single Inlet Pipe	9219 ③	--
<b>MERCEDES-BENZ C280</b>					
94-97	6	2.8L		9221 ③	--
<b>MERCEDES-BENZ C240</b>					
03-04	6	2.6L	Base, Right	4616 ③	--
03-04	6	2.6L	Base, Left	4617 ③	--

③ Federal & California Emissions. Not For Sale or Use on vehicles licensed in the state of CA & NY (NY vehicles with CA Emissions). Check with your state authority for details.

YR/YRS	CYL	LITER	DESCRIPTION	DIRECT FIT	UNIVERSAL
<b>MERCEDES-BENZ C320</b>					
03-04	6	3.2L	Base, Right	4616 ③	--
03-04	6	3.2L	Base, Left	4617 ③	--
<b>MERCEDES-BENZ CL500</b>					
00-03	8	5.0L	Right	4280 ③	--
00-03	8	5.0L	Left	4281 ③	--
<b>MERCEDES-BENZ CLK320</b>					
2003	6	3.2L	Convertible, Right	5059 ③	--
2003	6	3.2L	Convertible, Left	5190 ③	--
98-02	6	3.2L	Right	5059 ③	--
98-02	6	3.2L	Left	5190 ③	--
1998	6	3.2L	Right	5059 ③	--
1998	6	3.2L	Left	5190 ③	--
<b>MERCEDES-BENZ CLK430</b>					
2003	8	4.3L	Convertible, Single Outlet, Right	5059 ③	--
2003	8	4.3L	Convertible, Left	5190 ③	--
99-02	8	4.3L	Single Outlet, Right	5059 ③	--
99-02	8	4.3L	Left	5190 ③	--
<b>MERCEDES-BENZ CLK55 AMG</b>					
01-02	8	5.5L	Single Outlet, Right	5059 ③	--
01-02	8	5.5L	Single Outlet, Left	5190 ③	--
<b>MERCEDES-BENZ E320</b>					
04-05	6	3.2L	Base, RWD, Right	5051 ③	--
04-05	6	3.2L	Base, Left	5050 ③	--
04-05	6	3.2L	4Matic, Left	5042 ③	--
04-05	6	3.2L	4Matic, Right	5044 ③	--
2003	6	3.2L	4Matic Wagon, Left	5015 ③	--
2003	6	3.2L	4Matic Wagon, Right	5016 ③	--
2003	6	3.2L	Sedan, Right	5051 ③	--
2003	6	3.2L	Sedan, Left	5050 ③	--
98-02	6	3.2L	DF Right Side, (Exc. 4-Matic)	4296 ③	--
98-02	6	3.2L	Left	5015 ③	--
98-02	6	3.2L	Left	4297 ③①	--
98-02	6	3.2L	4Matic, Right	5016 ③	--
<b>MERCEDES-BENZ E420</b>					
1997	8	4.2L	Left Side Conv.	4981 ③	--
1997	8	4.2L	Right Side Conv.	4980 ③	--
<b>MERCEDES-BENZ E430</b>					
00-02	8	4.3L	Base & 4Matic, Left	5103 ③	--
00-02	8	4.3L	Base & 4Matic, Right	4579 ③	--
98-99	8	4.3L	Base, Left	5103 ③	--
98-99	8	4.3L	Base, Right	4579 ③	--
<b>MERCEDES-BENZ GL450</b>					
07-12	8	4.6L	Left	9883 ③	--
07-12	8	4.6L	Right	9884 ③	--
<b>MERCEDES-BENZ GL550</b>					
08-12	8	5.5L	Left	9883 ③	--
08-12	8	5.5L	Right	9884 ③	--

① Discontinued, use until inventory is depleted.

③ Federal & California Emissions. Not For Sale or Use on vehicles licensed in the state of CA & NY (NY vehicles with CA Emissions). Check with your state authority for details.

**APPLICATION LISTINGS**  
**FEDERAL CONVERTERS**



YR/YRS	CYL	LITER	DESCRIPTION	DIRECT FIT	UNIVERSAL
<b>MERCEDES-BENZ ML320</b>					
98-02	6	3.2L	SOHC & 163 Chassis, Right	4214 ③	--
98-02	6	3.2L	SOHC & 163 Chassis, Left	4215 ③	--
<b>MERCEDES-BENZ ML350</b>					
06-11	6	3.5L	Right	5206 ③	--
06-11	6	3.5L	Left	5205 ③	--
03-05	6	3.7L	Left	9413 ③	--
03-05	6	3.7L	Right	9414 ③	--
<b>MERCEDES-BENZ ML430</b>					
99-01	8	4.3L	Right Side	4478 ③	--
99-01	8	4.3L	Left Side	4479 ③	--
<b>MERCEDES-BENZ ML550</b>					
08-11	8	5.5L	Left	9883 ③	--
08-11	8	5.5L	Right	9884 ③	--
<b>MERCEDES-BENZ R350</b>					
06-12	6	3.5L	Right	5068 ③	--
<b>MERCEDES-BENZ S420</b>					
94-95	8	4.2L	w/140 Chassis	9149 ③	2910 ③
<b>MERCEDES-BENZ S430</b>					
03-06	8	4.3L	S430, 4Matic, Right	5144 ③	--
03-06	8	4.3L	S430, 4Matic, Left	5143 ③	--
00-02	8	4.3L	S430, Right	4280 ③	--
00-02	8	4.3L	S430, Left	4281 ③	--
<b>MERCEDES-BENZ S500</b>					
03-06	8	5.0L	4Matic, Left	5143 ③	--
03-06	8	5.0L	4Matic, Right	5144 ③	--
00-02	8	5.0L	Left	4281 ③	--
00-02	8	5.0L	Right	4280 ③	--
94-95	8	5.0L	w/140 Chassis	9149 ③	2910 ③
<b>MERCEDES-BENZ SLK320</b>					
01-04	6	3.2L	Right	4378 ③	2575 ③○
01-04	6	3.2L	Left	4379 ③	2575 ③○
<b>MERCURY BOBCAT</b>					
75-80	4	All	14" Conv.	--	6905 ③
75-80	4	All	19" Conv.	--	6905 ③
75-79	4	All	(Exc. 14" & 19" Conv.)	--	6904 ③
77-79	6	2.8L	14" Conv.	--	6905 ③
77-79	6	2.8L	19" Conv.	--	6905 ③
75-76	6	2.8L	Left	--	6904R ③
75-76	6	2.8L	Right	--	6904R ③
<b>MERCURY CAPRI</b>					
91-94	4	1.6L	13-3/4" Conv.	--	6804 ③
1991	4	1.6L	13-1/4" Conv.	4649 ③	6804 ③
84-86	4	2.3L	(Exc. Turbo)	--	6004 ③
1984	4	2.3L	Turbo	--	6905 ③
1983	4	2.3L	(Exc. Turbo)	--	6905 ③
1983	4	2.3L	California Emissions	--	6004 ⑤
1983	4	2.3L	Turbo	--	6905 ③
79-82	4	2.3L	w/o Air Tube	--	6905 ③

- ③ Federal & California Emissions. Not For Sale or Use on vehicles licensed in the state of CA & NY (NY vehicles with CA Emissions). Check with your state authority for details.
- ⑤ California Emissions. Not For Sale or Use on vehicles licensed in the state of CA & NY. Check with your state authority.
- EPA Enhanced OBDII By Design Unit



YR/YRS	CYL	LITER	DESCRIPTION	DIRECT FIT	UNIVERSAL
<b>MERCURY CAPRI (Cont.)</b>					
79-82	4	2.3L	w/Air Tube	--	6005③
76-77	6	2.8L	Dual Convs., Left	--	6904R③
76-77	6	2.8L	Dual Convs., Right	--	6904R③
1976	6	2.8L	(Exc. Dual Convs.)	--	6905③
84-86	6	3.8L	Underbody	--	6005③
84-86	6	3.8L	Main & Pre-Cat	--	6005③
1983	6	3.8L		--	6005③
1983	6	3.8L	Main & Pre-Cat	--	6004③
79-82	6	All	Rear	--	6904③
79-82	6	All	Main & Pre-Cat	--	6004③
1982	8	4.2L	Rear	--	6005③
1982	8	4.2L	Main & Pre-Cat	--	6004③
1981	8	4.2L	Rear	--	6005③
1981	8	4.2L	Main & Pre-Cat	--	6005③
1986	8	5.0L	Rear Left	--	6005③
1986	8	5.0L	Complete	4166 ③	--
1986	8	5.0L	Front Right	--	6005③
1986	8	5.0L	Front Left	--	6005③
1986	8	5.0L	Rear Right	--	6005③
84-85	8	5.0L	Rear, Manual Trans.	--	6006③
84-85	8	5.0L	Manual Trans., Main & Pre-Cat	--	6006③
84-85	8	5.0L	Auto Trans., Rear	--	6006③
84-85	8	5.0L	Auto Trans., Main & Pre-Cat	--	6006③
1983	8	5.0L	Auto Trans., Rear	--	6006③
1983	8	5.0L	Auto Trans., Main & Pre-Cat	--	6006③
1982	8	5.0L	25" Conv., Rear	--	6005③
1982	8	5.0L	25" Conv., Main & Pre-Cat	--	6004③
79-80	8	All	Rear	--	6904③
79-80	8	All	Main & Pre-Cat	--	6004③
<b>MERCURY COMET</b>					
75-76	6	All		--	6904③
75-76	8	All		--	6905③
1977	6,8	All	14-1/4" Conv.	--	6905③
1977	6,8	All	(Exc. 14-1/4" Conv.)	--	6905③
<b>MERCURY COUGAR</b>					
99-02	4	2.0L		4140 ③	--
84-86	4	2.3L	XR7 Models w/Turbo	--	6906③
99-00	6	2.5L	Rear Side Manifold Conv.	1011 ③	--
99-00	6	2.5L	Front Side Manifold Conv.	1012 ③	--
99-00	6	2.5L	Main Conv., Auto Trans, w/O2 Sensor	4147 ③	2504③
99-00	6	2.5L	Main Conv., Manual Trans.	4860 ③	2505③
80-82	6	3.3L	Rear	--	6904③
80-82	6	3.3L	Main & Pre-Cat	--	6004③
96-97	6	3.8L	Front Left	--	2554③
96-97	6	3.8L	Rear	--	2540③
96-97	6	3.8L	Complete	4858 ③	--
96-97	6	3.8L	Front Right	--	2554③

③ Federal & California Emissions. Not For Sale or Use on vehicles licensed in the state of CA & NY (NY vehicles with CA Emissions). Check with your state authority for details.

**APPLICATION LISTINGS**  
**FEDERAL CONVERTERS**



YR/YRS	CYL	LITER	DESCRIPTION	DIRECT FIT	UNIVERSAL
<b>MERCURY COUGAR (Cont.)</b>					
92-95	6	3.8L	w/O2 Sensor Ports, Front Left	--	6804③
92-95	6	3.8L	Complete, w/O2 Sensor Ports	4885 ③	--
92-95	6	3.8L	w/O2 Sensor Ports, Front Right	--	6804③
91-95	6	3.8L	Exc. Conv. w/O2 Sensor Ports, Front Left	--	6804③
91-95	6	3.8L	Exc. Conv. w/O2 Sensor Ports, Front Right	--	6804③
89-90	6	3.8L	Left, (Exc. XR-7)	--	6904③
89-90	6	3.8L	Right, (Exc. XR-7)	--	6904③
84-88	6	3.8L	Rear	--	6005③
84-88	6	3.8L	Main & Pre-Cat	--	6005③
82-83	6	3.8L	Rear	--	6005③
82-83	6	3.8L	Main & Pre-Cat	--	6004③
96-97	8	4.6L	Front Left	--	2554③○
96-97	8	4.6L		--	2513③
96-97	8	4.6L	Complete	4152 ③	--
96-97	8	4.6L	Front Right	--	2554③○
94-95	8	4.6L	w/Post Conv. O2 Sensor, Front Left	--	2504③
94-95	8	4.6L	Rear, w/Post Conv. O2 Sensor Port	--	2513③
94-95	8	4.6L	Complete, w/Post Conv. O2 Sensor Port	4593 ③	--
94-95	8	4.6L	w/o Post Conv. O2 Sensor Port, Front Left	--	6904③
94-95	8	4.6L	Rear, w/out Post Conv. O2 Sensor Port	--	2913③
94-95	8	4.6L	w/Post Conv. O2 Sensor, Front Right	--	2504③
94-95	8	4.6L	w/o Post Conv. O2 Sensor Port, Front Right	--	6904③
91-93	8	5.0L	Left	--	6904③
91-93	8	5.0L	Right	--	6904③
91-93	8	5.0L		--	2913③
91-93	8	5.0L	Complete System	4110 ③	--
86-88	8	5.0L	Rear, w/3 Conv. System	--	6005③
86-88	8	5.0L	Main & Pre-Cat, w/3 Conv. System	--	6005③
83-85	8	5.0L	Left	--	6005③
83-85	8	5.0L	Right	--	6005③
77-78	8	6.6L	Left	--	9004③
77-78	8	6.6L	Right	--	9004③
75-76	8	7.5L	Left	--	9004③
75-76	8	7.5L	Right	--	9004③
80-82	8	All		--	6005③
80-82	8	All	Main & Pre-Cat	--	6005③
77-79	8	All	Exc. 400 C.I.D., Left	--	6904R③
77-79	8	All	Exc. 400 C.I.D., Right	--	6904R③
<b>MERCURY GRAND MARQUIS FULL SIZE</b>					
03-11	8	4.6L	Rear Left	--	2564③
03-11	8	4.6L	Front Left	--	2554③
03-11	8	4.6L	Right	4803 ③	--
03-11	8	4.6L	Left	5002 ③	--
03-11	8	4.6L	Rear Right	--	2564③
03-11	8	4.6L	Front Right	--	2554③
03-06	8	4.6L	Left	4271 ③○	--
03-06	8	4.6L	Right	4270 ③○	--

- Discontinued, use until inventory is depleted.
- ③ Federal & California Emissions. Not For Sale or Use on vehicles licensed in the state of CA & NY (NY vehicles with CA Emissions). Check with your state authority for details.
- EPA Enhanced OBDII By Design Unit

YR/YRS	CYL	LITER	DESCRIPTION	DIRECT FIT	UNIVERSAL
<b>MERCURY GRAND MARQUIS FULL SIZE (Cont.)</b>					
96-02	8	4.6L	Left	4870 ③	--
96-02	8	4.6L	Right	4871 ③	--
96-02	8	4.6L	Front Left	--	2538③
96-02	8	4.6L	Rear Left	--	2504③
96-02	8	4.6L	Front Right	--	2538③
96-02	8	4.6L	Rear Right	--	2504③
1995	8	4.6L	Left	4598 ③	2504③
1995	8	4.6L	Right	4599 ③	2504③
92-94	8	4.6L	Left	4521 ③	6904③
92-94	8	4.6L	Right	4520 ③	6904③
90-91	8	5.0L	Left, Main & Pre-Cat	4245 ☆③	6004③
90-91	8	5.0L	Right Side, Main & Pre-Cat	4244 ☆③	6004③
1989	8	5.0L	Left, Main & Pre-Cat	4245 ☆③	6004③
1989	8	5.0L	Right Side, Main & Pre-Cat	4244 ☆③	6004③
86-88	8	5.0L	Left, Main & Pre-Cat	4245 ☆③	6004③
86-88	8	5.0L	Right Side, Main & Pre-Cat	4244 ☆③	6004③
83-85	8	5.0L	Left	--	6004③
83-85	8	5.0L	Right	--	6004③
<b>MERCURY LN7</b>					
1983	4	1.6L		--	6004③
1982	4	1.6L		--	6004③
<b>MERCURY LYNX</b>					
83-85	4	1.6L		--	6004③
81-82	4	1.6L		--	6004③
1987	4	1.9L	C.F.I.	--	6804③
86-87	4	1.9L	E.F.I.	4122 ☆③	--
85-86	4	1.9L	2 bbl. Carb.	--	6004③
<b>MERCURY MARAUDER</b>					
03-04	8	4.6L	Right	4803 ③	--
03-04	8	4.6L	Right, Single Exhaust, Built From 6/3/02	4270 ③①	--
03-04	8	4.6L	Left	5002 ③	--
03-04	8	4.6L	Left, Single Exhaust, Built From 6/3/02	4271 ③①	--
03-04	8	4.6L	Front Left	--	2555③○
03-04	8	4.6L	Front Right	--	2555③○
03-04	8	4.6L	Rear Left	--	2575③○
03-04	8	4.6L	Rear Right	--	2575③○
<b>MERCURY MARINER</b>					
06-08	4	2.3L	Front Manifold Conv., From 10/03/05, Convenience & Base Submodels, Exc. Hybrid	1136 ③	--
05-08	4	2.3L	Rear Main	9408 ③	--
10-11	4	2.5L	Base, Premier; Exc. Hybrid; Requires Welded Assembly 60005 to Complete Assembly	9981 ③	--
10-11	6	3.0L	Manifold Unit, Front Right	1289 ③	--
09-11	6	3.0L	Rear	9530 ③	--
2008	6	3.0L	Manifold Unit, Front Left	1283 ③	--
05-06	6	3.0L	Manifold Unit, Front	1148 ③	--
05-06	6	3.0L	Rear Manifold Conv.	1147 ③	--

① Discontinued, use until inventory is depleted.

☆ Air Tube kit 4948 may be required for installation.

③ Federal & California Emissions. Not For Sale or Use on vehicles licensed in the state of CA & NY (NY vehicles with CA Emissions). Check with your state authority for details.

○ EPA Enhanced OBDII By Design Unit

**APPLICATION LISTINGS  
FEDERAL CONVERTERS**



YR/YRS	CYL	LITER	DESCRIPTION	DIRECT FIT	UNIVERSAL
<b>MERCURY MARINER (Cont.)</b>					
05-06	6	3.0L	Rear Main	9408 ③	--
<b>MERCURY MARQUIS</b>					
81-82	8	4.2L	Right	--	6004③
81-82	8	4.2L	Left	--	6004③
81-82	8	5.8L	Right	--	2904③
81-82	8	5.8L	Left	--	2904③
1978	8	5.8L	Right	--	6904R③
1978	8	5.8L	Left	--	6904R③
75-78	8	6.6L	Right	--	9004③
75-78	8	6.6L	Left	--	9004③
79-80	8	All	Right	--	6004③
79-80	8	All	Left	--	6004③
<b>MERCURY MARQUIS MIDSIZE</b>					
84-86	4	2.3L	39" Conv.	--	6004③
1983	4	2.3L	Front	--	6904③
1983	4	2.3L	Rear	--	6904③
1983	4	2.3L	Main & Pre-Cat	--	6004③
1983	6	3.3L	Rear	--	6904③
1983	6	3.3L	Main & Pre-Cat	--	6004③
84-86	6	3.8L	w/ Fuel Injection, Rear	--	6005③
84-86	6	3.8L	w/ Fuel Injection, Main & Pre-Cat	--	6005③
1984	6	3.8L	EEC, Rear	--	6004③
1984	6	3.8L	EEC, Main & Pre-Cat	--	6005③
1984	6	3.8L	Rear, (Exc. Fuel Injection & EEC)	--	6005③
1984	6	3.8L	(Exc. Fuel Injection & EEC), Main & Pre-Cat	--	6004③
1983	6	3.8L		--	6005③
1983	6	3.8L	Main & Pre-Cat	--	6004③
<b>MERCURY MILAN</b>					
07-09	4	2.3L	With Air Tube, Auto Trans., California Emissions, Front	1202 ⑤	--
10-11	6	3.0L	Front Right	1284 ③	--
06-11	6	3.0L	Manifold Unit, Front Left	1211 ③	--
			Manifold Unit, Front Left	1122 ③⑤	--
07-08	6	3.0L	Rear Manifold Conv., AWD, 09-04-06 to 12-03-07	1145 ③	--
06-08	6	3.0L	Rear Manifold Conv., FWD	1123 ③	--
06-08	6	3.0L	Rear Main Conv., FWD	4453 ③	2505③
<b>MERCURY MONARCH</b>					
1980	6	4.1L	(Exc. 14-1/4" Conv.), Rear	--	6004③
1980	6	4.1L	(Exc. 14-1/4" Conv.), Main & Pre-Cat	--	6004③
78-80	6	4.1L	14-1/4" Conv., Rear	--	6905③
77-79	6	4.1L	18" Conv.	--	6905③
75-76	6	All		--	6904③
77-79	8	5.0L	(Exc. 18" Conv.)	--	6905③
77-79	8	5.0L	18" Conv.	--	6905③
75-76	8	5.0L		--	6905③
1977	8	5.8L	Left	--	6904R③
1977	8	5.8L	Right	--	6904R③
75-76	8	5.8L	Left	--	6904R③

④ Discontinued, use until inventory is depleted.

③ Federal & California Emissions. Not For Sale or Use on vehicles licensed in the state of CA & NY (NY vehicles with CA Emissions). Check with your state authority for details.

⑤ California Emissions. Not For Sale or Use on vehicles licensed in the state of CA & NY. Check with your state authority.

YR/YRS	CYL	LITER	DESCRIPTION	DIRECT FIT	UNIVERSAL
<b>MERCURY MONARCH (Cont.)</b>					
75-76	8	5.8L	Right	--	6904R③
1980	8	All		--	6905③
<b>MERCURY MONTEGO</b>					
05-07	6	3.0L	Front, 2WD	4390 ③	--
05-07	6	3.0L	Front, AWD	4490 ③	--
05-07	6	3.0L	Rear	4391 ③	--
05-07	6	3.0L	Rear Main Conv.	4392 ③	2565③
75-76	8	5.8L	Left	--	6904R③
75-76	8	5.8L	Right	--	6904R③
75-76	8	6.6L	Left	--	9004③
75-76	8	6.6L	Right	--	9004③
75-76	8	7.5L	Left	--	9004③
75-76	8	7.5L	Right	--	9004③
<b>MERCURY MONTEREY</b>					
04-07	6	4.2L		4372 ③	--
<b>MERCURY MOUNTAINEER</b>					
06-10	6	4.0L	Complete Assembly	9172 ③	--
06-07	6	4.0L	Left	--	2565R③○
06-07	6	4.0L	Right	--	2565R③○
02-05	6	4.0L	Code "E" Eng., Front	--	2504R③
02-05	6	4.0L	Code "E" Eng., Rear	--	2516③
02-05	6	4.0L	Code "E" Eng., Complete Assembly	9112 ③	--
98-01	6	4.0L	LEV Code "E" Eng., w/Single Inlet Pipe Muffler, Front Convs., California Emissions	1044 ⑤	--
98-01	6	4.0L	LEV Code "E" Eng., w/Single Inlet Pipe Muffler, Rear Convs., California Emissions	9244 ⑤	--
98-01	6	4.0L	Code "E", w/ Dual Inlet Pipe Muffler, Left	4045 ③	2505R③
98-01	6	4.0L	Code "E", w/ Dual Inlet Pipe Muffler, Right Conv. w/Left Side Extension Pipe	4044A ③	2505③
98-01	6	4.0L	Code "E", w/ Dual Inlet Muffler, Right Conv. w/o Left Side Extension Pipe	4044 ③	2505③
06-10	8	4.6L	Complete Assembly	4582 ③	--
02-05	8	4.6L	Complete Assembly	9173 ③	--
02-05	8	4.6L	Front Left	--	2504R③
02-05	8	4.6L	Rear Universal	--	2516③
02-05	8	4.6L	Front Right	--	2504R③
98-00	8	5.0L	Left; From 2/98	4868 ③	--
98-00	8	5.0L	Right; From 2/98	4869 ③	--
97-98	8	5.0L	Front Right; To 1/98	4881 ③	--
97-98	8	5.0L	Front Left; To 1/98	4882 ③	--
97-98	8	5.0L	Rear Right; To 1/98	--	2515③
97-98	8	5.0L	Rear Left; To 1/98	--	2515③
97-98	8	5.0L	Complete Rear Assembly; To 1/98	9029 ③	--
<b>MERCURY MYSTIQUE</b>					
98-00	4	2.0L	(Exc. Eng. Code Z)	4140 ③	--
95-97	4	2.0L		4878 ③	--
95-00	6	2.5L	Rear Side Manifold Conv.	1011 ③	--

③ Federal & California Emissions. Not For Sale or Use on vehicles licensed in the state of CA & NY (NY vehicles with CA Emissions). Check with your state authority for details.

⑤ California Emissions. Not For Sale or Use on vehicles licensed in the state of CA & NY. Check with your state authority.

○ EPA Enhanced OBDII By Design Unit

# APPLICATION LISTINGS

## FEDERAL CONVERTERS



YR/YRS	CYL	LITER	DESCRIPTION	DIRECT FIT	UNIVERSAL
<b>MERCURY MYSTIQUE (Cont.)</b>					
95-00	6	2.5L	Front Side Manifold Conv.	1012 ③	--
95-00	6	2.5L	Rear, Auto Trans., w/O2 Sensor	4147 ③	2504③
95-00	6	2.5L	Main Conv., Manual Trans.	4860 ③	2505③
95-96	6	2.5L	Main Conv., Without O2 Sensor, Auto Trans.	4722 ③	6904③
<b>MERCURY SABLE</b>					
00-05	6	3.0L	Front, 12 valve	4184 ③	--
00-05	6	3.0L	Rear, 12 valve	4185 ③	--
00-05	6	3.0L	Front Y Type Conv., 24 valve Eng.	1084 ③	--
00-05	6	3.0L	Rear Manifold Conv., 24 valve Eng.	1085 ③	--
00-05	6	3.0L	Rear Main Conv., 24 valve Eng.	4185 ③	--
96-99	6	3.0L	24 valve	4052 ③	--
96-99	6	3.0L	12 valve, Code "U", AX4S Trans	4888 ③	--
96-99	6	3.0L	12 valve, Code "U", AX4N Trans	4888 ③	--
96-99	6	3.0L	LEV Models, 12 valve	4221 ③	--
93-95	6	3.0L	w/Dual Convs.	4663 ③	6804③
86-94	6	3.0L	w/Single Conv.	4073 ③	--
08-09	6	3.5L	Rear, Federal Emissions	4455 ④	--
08-09	6	3.5L	Front, Federal Emissions	4454 ④	--
08-09	6	3.5L	FWD, Left	--	2555③○
08-09	6	3.5L	Rear, California Emissions	4712 ⑤	--
08-09	6	3.5L	FWD, Right	--	2555③○
91-95	6	3.8L		4118 ③	6904③
88-90	6	3.8L	Rear	--	6004③
88-90	6	3.8L	Main & Pre-Cat	--	6004③
<b>MERCURY TOPAZ</b>					
85-94	4	2.3L		4122 ☆③	--
1984	4	2.3L		--	6004③
92-94	6	3.0L		4526 ③	6904③
<b>MERCURY TRACER</b>					
88-89	4	1.6L	Reversible/Non-Directional Unit	--	6904③
1987	4	1.6L		--	6905③
91-95	4	1.8L		--	6904③
1996	4	1.9L		4604 ③	2538③
91-95	4	1.9L	EGR Port on Conv.	4612 ③	2538③
91-95	4	1.9L	w/o EGR Port on Conv.	4113 ③	2538③
97-99	4	2.0L		4865 ③	2538③
<b>MERCURY VILLAGER</b>					
96-98	6	3.0L	Front	4587 ③	2564R③
96-98	6	3.0L		4588 ③	2505③
94-95	6	3.0L	Front	4587 ③	6905R③
94-95	6	3.0L		4588 ③	6905③
1993	6	3.0L		4588 ③	6905③
01-02	6	3.3L	Manifold Unit, Front Left	1291 ③	--
99-02	6	3.3L		4588 ③	2505③
99-00	6	3.3L	California Emissions, Manifold Unit, Front Left	1291 ⑤	--

☆ Air Tube kit 4948 may be required for installation.

③ Federal & California Emissions. Not For Sale or Use on vehicles licensed in the state of CA & NY (NY vehicles with CA Emissions). Check with your state authority for details.

④ Federal Emissions. Not For Sale or Use on vehicles licensed in the state of CA. Check with your state authority.

⑤ California Emissions. Not For Sale or Use on vehicles licensed in the state of CA & NY. Check with your state authority.

○ EPA Enhanced OBDII By Design Unit

YR/YRS	CYL	LITER	DESCRIPTION	DIRECT FIT	UNIVERSAL
<b>MERCURY ZEPHYR</b>					
1983	4	2.3L	39" Conv.	--	6004③
81-83	4	2.3L	(Exc. 39" Conv.)	--	6005③
78-80	4	2.3L	17" Conv.	--	6904③
78-83	6	3.3L	Rear	--	6904③
78-83	6	3.3L	Main & Pre-Cat	--	6004③
1982	8	4.2L	23" Conv., Rear	--	6005③
1982	8	4.2L	23" Conv., Main & Pre-Cat	--	6004③
1982	8	4.2L	25" Conv., Rear	--	6004③
1982	8	4.2L	25" Conv., Main & Pre-Cat	--	6004③
1981	8	4.2L		--	6005③
1981	8	4.2L	Main & Pre-Cat	--	6004③
1980	8	4.2L		--	6904③
1980	8	4.2L	Main & Pre-Cat	--	6004③
78-79	8	5.0L	Rear	--	6904③
<b>MERKUR SCORPIO</b>					
88-89	6	2.9L	Front	--	6904③
88-89	6	2.9L		--	6004③
88-89	6	2.9L	Main & Pre-Cat	--	6004③
<b>MERKUR XR4TI</b>					
85-89	4	All		--	6905③
<b>MINI COOPER</b>					
09-15	4	1.6L	Turbocharged, Convertible, Front	1340 ③	--
07-15	4	1.6L	Naturally Aspirated, Manifold Unit, Front	1317 ③	--
07-14	4	1.6L	Turbocharged, Hatchback, Front	1340 ③	--
2009	4	1.6L	S Model, Convertible, Rear	5215 ③	--
08-09	4	1.6L	S Clubman Model, Hatchback, Rear	5215 ③	--
07-09	4	1.6L	S Model, Hatchback, Rear	5215 ③	--
07-08	4	1.6L	Convertible, Manifold Unit, Front	1292 ③	--
02-06	4	1.6L	R50, R52 or R53	--	2515③
02-06	4	1.6L	Manifold Unit, Front	1292 ③	--
<b>MITSUBISHI 3000GT</b>					
91-99	6	3.0L		4408 ③	6005③
<b>MITSUBISHI CORDIA, TREDIA</b>					
83-88	4	All	Rear	4203 ③	6904R③
83-88	4	All	Main & Pre-Cat	--	6004③
<b>MITSUBISHI DIAMANTE</b>					
94-95	6	3.0L	Front Left	--	6905R③
94-95	6	3.0L		--	6905③
94-95	6	3.0L	Front Right	--	6905R③
92-93	6	3.0L		4408 ③	6905③
99-02	6	3.5L	Front Side	1094 ③	--
99-02	6	3.5L	Rear Side	1095 ③	--
<b>MITSUBISHI ECLIPSE</b>					
95-98	4	2.0L		4359 ③	2505③
06-11	4	2.4L	Front Conv.	4409 ③	--
06-09	4	2.4L	Rear, Does NOT Include Resonator Pipe	4609 <sup>900</sup> ③	2565R③○
00-05	4	2.4L	Rear, From 06/00	4332 ③	2505③

<sup>900</sup> Direct fit converter may require resizing, cutting or bushing.

③ Federal & California Emissions. Not For Sale or Use on vehicles licensed in the state of CA & NY (NY vehicles with CA Emissions). Check with your state authority for details.

○ EPA Enhanced OBDII By Design Unit

# APPLICATION LISTINGS

## FEDERAL CONVERTERS



YR/YRS	CYL	LITER	DESCRIPTION	DIRECT FIT	UNIVERSAL
<b>MITSUBISHI ECLIPSE (Cont.)</b>					
00-05	4	2.4L	Front, From 06/00	1082 ③	--
1999	4	2.4L	Front, Convertible Models, California Emissions; To 5/00	1096 ⑤	--
1999	4	2.4L	Rear, Convertible Models, California Emissions; To 5/00	4196 ⑤	2540 ⑤
96-98	4	2.4L		4359 ③	2505 ③
90-94	4	All		4377 ③	6904 ③
00-05	6	3.0L	Front Side	1094 ③	--
00-05	6	3.0L	Rear Side	1095 ③	--
00-05	6	3.0L	Main Rear, From 06/00	4393 ③	2540 ③
06-12	6	3.8L	With Curved Outlet Pipe, Manifold Unit, Front Right	1295 ③	--
06-10	6	3.8L	Manifold Unit, Front	1900 ③	--
06-10	6	3.8L	Without Curved Outlet Pipe, Rear Manifold Conv.	1901 ③	--
06-10	6	3.8L	Rear Main Conv.	4985 ③	--
<b>MITSUBISHI ENDEAVOR</b>					
10-11	6	3.8L	Rear, Requires resonator pipe 78295 (FWD) or 78294 (AWD) to complete installation as OE was a welded assembly	5127 ③	2575 ③
04-08	6	3.8L	Rear, Requires resonator pipe 78295 (FWD) or 78294 (AWD) to complete installation as OE was a welded assembly	5127 ③	2575 ③
2004	6	3.8L	AWD, Front Manifold Conv.	1102 ③	--
2004	6	3.8L	AWD, Rear Manifold Conv.	1103 ③	--
2004	6	3.8L	AWD, Rear Main Conv., To cut and fit with OE resonator pipe	9217 ③	2516 ③
<b>MITSUBISHI EXPO</b>					
92-95	4	All		4377 ③	6904 ③
92-94	4	All	4WD	--	6904 ③
<b>MITSUBISHI EXPO VAN</b>					
92-95	4	2.4L	Expo Models, 2WD	4377 ③	6904 ③
<b>MITSUBISHI GALANT</b>					
89-92	4	2.0L		4377 ③	6904 ③
04-12	4	2.4L	Rear, Cut as Required & Adapter 8909 Required to Mate to OE Resonator Pipe	4848 ③	--
04-12	4	2.4L	Front	4409 ③	--
00-03	4	2.4L	Front, From 06/00	1082 ③	--
00-03	4	2.4L	Rear, From 06/00	4332 ③	2505 ③
99-00	4	2.4L	Federal Emissions; To 5/00	4433 ④	2505 ④
99-00	4	2.4L	Front, California Emissions; To 5/00	1096 ⑤	--
99-00	4	2.4L	Rear, California Emissions; To 5/00	4196 ⑤	2540 ⑤
95-98	4	2.4L	SOHC, Rear	4359 ③	2504 ③
1994	4	2.4L	SOHC, Rear	4359 ③	6904 ③
85-87	4	2.4L	24" Conv.	--	6904 ③
00-03	6	3.0L	Rear Main Conv., From 06/00	4393 ③	2540 ③
99-03	6	3.0L	Front Side	1094 ③	--
99-03	6	3.0L	Rear Side	1095 ③	--
99-00	6	3.0L	Rear Main Conv., California Emissions, To 05/00	4393 ⑤	2540 ⑤
1988	6	3.0L	Sigma	--	6904 ③
07-09	6	3.8L	Manifold Unit, Front	1900 ③	--
07-09	6	3.8L	Without Curved Outlet Pipe, Rear Manifold Conv.	1901 ③	--
06-09	6	3.8L	Rear Main Conv.	4985 ③	--
04-09	6	3.8L	With Curved Outlet Pipe, Manifold Unit, Front Right	1295 ③	--

③ Federal & California Emissions. Not For Sale or Use on vehicles licensed in the state of CA & NY (NY vehicles with CA Emissions). Check with your state authority for details.

④ Federal Emissions. Not For Sale or Use on vehicles licensed in the state of CA. Check with your state authority.

⑤ California Emissions. Not For Sale or Use on vehicles licensed in the state of CA & NY. Check with your state authority.



YR/YRS	CYL	LITER	DESCRIPTION	DIRECT FIT	UNIVERSAL
<b>MITSUBISHI GALANT (Cont.)</b>					
04-05	6	3.8L	Rear	5173 ③	--
<b>MITSUBISHI LANCER</b>					
2008	4	2.0L	Naturally Aspirated	5204 ③	--
05-07	4	2.0L	Rear, (Exc. Turbo)	4686 ③	--
02-07	4	2.0L	Naturally Aspirated, Manifold Unit, Front	1271 ③	--
			Naturally Aspirated, Manifold Unit, Front	1086 ③④	--
02-03	4	2.0L	Rear, (Exc. Turbo)	4286 ③	2504 ③
2004	4	2.4L		5038 ③	--
<b>MITSUBISHI MIRAGE</b>					
00-02	4	1.5L	Front, From 06/00	1117 ③	--
00-02	4	1.5L	Rear, From 06/00	4457 ③	--
97-00	4	1.5L	DE Models, To 05/00, Federal Emissions	4195 ④	2504 ④
97-00	4	1.5L	Front, California Emissions, To 05/00	1117 ⑤	--
97-00	4	1.5L	Rear, California Emissions; To 5/00	4457 ⑤	--
93-95	4	1.5L		--	6905 ③
87-88	4	1.5L		4203 ③	6904R ③
87-88	4	1.6L	Turbo	4203 ③	6904R ③
97-02	4	1.8L	Under Body Conv.	4713 ③	--
93-95	4	1.8L		--	6905 ③
89-92	4	All		4377 ③	6904 ③
85-86	4	All	Rear	--	6904 ③
85-86	4	All	Main & Pre-Cat	--	6004 ③
<b>MITSUBISHI MONTERO</b>					
87-89	4	2.6L		4203 ③	6904 ③
83-86	4	2.6L		--	6805 ③
95-00	6	3.0L		--	2540 ③
93-94	6	3.0L		--	2505 ③
89-92	6	3.0L		--	6904 ③
01-02	6	3.5L	Front, (Exc. Sport)	1106 ③	--
01-02	6	3.5L	Rear, (Exc. Sport)	9265 ③	2506 ③
99-00	6	3.5L	Federal Emissions, Exc. Sport Model	4291 ④	2505 ④
97-98	6	3.5L	Federal Emissions	4291 ④	2505 ④
94-96	6	3.5L		4291 ③	2505 ③
04-06	6	3.8L	Front Y-Pipe Conv.	5210 ③	--
03-06	6	3.8L	Center	5211 ③	--
<b>MITSUBISHI MONTERO SPORT</b>					
98-99	4	2.4L		--	2504 ③
01-03	6	3.0L	Front Right	1064 ③	--
01-03	6	3.0L	Front Left	1065 ③	--
01-03	6	3.0L	Rear	4465 ③	2505 ③
97-01	6	3.0L	Federal Emissions	4711 ④	--
99-00	6	3.0L	California Emissions, Right	4003 ⑤	--
99-00	6	3.0L	California Emissions, Front Left	5170 ⑤	--
99-01	6	3.5L	Federal Emissions	4711 ④	--
99-00	6	3.5L	Front Left	5171 ③	--
99-00	6	3.5L	California Emissions, Front Right	5172 ⑤	--

① Discontinued, use until inventory is depleted.

② Federal & California Emissions. Not For Sale or Use on vehicles licensed in the state of CA & NY (NY vehicles with CA Emissions). Check with your state authority for details.

④ Federal Emissions. Not For Sale or Use on vehicles licensed in the state of CA. Check with your state authority.

⑤ California Emissions. Not For Sale or Use on vehicles licensed in the state of CA & NY. Check with your state authority.

**APPLICATION LISTINGS**  
**FEDERAL CONVERTERS**



YR/YRS	CYL	LITER	DESCRIPTION	DIRECT FIT	UNIVERSAL
<b>MITSUBISHI OUTLANDER</b>					
08-09	4	2.4L	Center	5065 ③	--
03-06	4	2.4L	FWD	4403 ③	2534R③
07-13	6	3.0L	Manifold Unit, Front Left	1308 ③	--
07-13	6	3.0L	Manifold Unit, Front Right	1309 ③	--
07-09	6	3.0L	AWD, Federal Emissions	5193 ④	--
<b>MITSUBISHI PICKUP</b>					
85-86	4	2.0L		--	6904③
90-95	4	2.4L		4377 ③	6904③
85-86	4	2.6L		--	6904③
87-89	4	All		--	6905R③
83-84	4	All		--	6904③
90-94	6	3.0L	4WD	--	6904③
<b>MITSUBISHI PRECIS</b>					
90-94	4	1.5L		4377 ③	6904③
87-89	4	All	Rear	--	6904③
87-89	4	All	Main & Pre-Cat	--	6004③
<b>MITSUBISHI SIGMA</b>					
89-90	6	3.0L		--	6904③
<b>MITSUBISHI STARION</b>					
83-89	6	2.6L	Turbo, Rear	--	6904③
<b>MITSUBISHI VAN</b>					
87-90	4	2.4L		4377 ③	6904③
<b>NISSAN 200SX</b>					
97-98	4	1.6L	SE Models	4058 ③	--
95-96	4	1.6L	Underfloor	4841 ③	--
95-96	4	1.6L	Front, SE Models, California Emissions	4058 ⑤	--
1995	4	1.6L	Optional Converter, Underfloor	4408 ③	6905③
86-87	4	1.8L	Turbo Built After 1/86	--	6906③
84-86	4	1.8L	Turbo,	4408 ③	6905③
1998	4	2.0L		4481 ③	2505③
95-97	4	2.0L	SE-R Models, 16 Valve Twin Cam	4841 ③	--
1995	4	2.0L	Optional Conv.	4408 ③	6905③
86-88	4	2.0L	Built after 1/86	--	6906③
84-86	4	2.0L	Built before 1/86	4408 ③	6905③
81-83	4	All		4408 ③	6905③
1980	4	All		4377 ③	6904③
77-79	4	All	w/Conv.	4408 ③	6905③
87-88	6	3.0L		--	6906③
<b>NISSAN 240SX</b>					
95-98	4	2.4L	Front	4323 ③	2554③
95-98	4	2.4L		4317 ③	2545③
93-94	4	2.4L		4408 ③	6905③
89-92	4	All	Coupe, Hatchback	4087 ③	6906③
<b>NISSAN 280Z, 280ZX</b>					
81-83	6	2.8L	Turbo	4408 ③	6905③
1980	6	2.8L	(Exc. Turbo)	4377 ③	6904③
1979	6	All	Federal Emissions	4377 ④	6904④

③ Federal & California Emissions. Not For Sale or Use on vehicles licensed in the state of CA & NY (NY vehicles with CA Emissions). Check with your state authority for details.

④ Federal Emissions. Not For Sale or Use on vehicles licensed in the state of CA. Check with your state authority.

⑤ California Emissions. Not For Sale or Use on vehicles licensed in the state of CA & NY. Check with your state authority.

YR/YRS	CYL	LITER	DESCRIPTION	DIRECT FIT	UNIVERSAL
<b>NISSAN 280Z, 280ZX (Cont.)</b>					
1979	6	All	California Emissions	4408 ⑤	6905 ⑤
75-78	6	All		4408 ③	6905 ③
<b>NISSAN 300ZX</b>					
90-95	6	3.0L	(Exc. Turbo), Right	--	6005 ③
90-95	6	3.0L	(Exc. Turbo), Left	--	6005 ③
90-95	6	3.0L	Turbo, Left	--	6006 ③
90-95	6	3.0L	Turbo, Right	--	6006 ③
90-94	6	3.0L	Manual Trans., Turbo, Right	--	6904R ③
90-94	6	3.0L	Manual Trans., Turbo, Left	--	6904R ③
84-89	6	3.0L		--	6906 ③
<b>NISSAN 310</b>					
79-80	4	1.4L	w/2-1/4" Exhaust Piping	4408 ③	6905 ③
81-82	4	1.5L	w/2" Exhaust Piping	4377 ③	6904 ③
<b>NISSAN 350Z</b>					
03-06	6	3.5L	Right	4192 ③	--
03-06	6	3.5L	Left	4193 ③	--
<b>NISSAN 510, F-10</b>					
79-81	4	All	w/2" Exhaust Piping, Federal Emissions	4377 ④	6904 ④
79-81	4	All	w/2-1/4" Exhaust Piping, California Emissions	4408 ⑤	6905 ⑤
<b>NISSAN 810</b>					
81-84	6	2.4L	w/2-1/4" Exhaust Piping	4408 ③	6905 ③
79-80	6	2.4L	w/2" Exhaust Piping	4377 ③	6904 ③
78-79	6	2.4L	w/2-1/4" Exhaust Piping, California Emissions	4408 ⑤	6905 ⑤
<b>NISSAN ALTIMA</b>					
00-01	4	2.4L	Front, California Emissions	1017 ⑤	--
00-01	4	2.4L	Rear, California Emissions	4317 ⑤	2545 ⑤
98-01	4	2.4L	GXE, GLE & XE, Federal Emissions	1017 ④	--
95-97	4	2.4L	Front	1041 ③	--
95-97	4	2.4L	Rear	4841 ③	--
93-94	4	2.4L	w/O2 Sensor in Conv.	4841 ③	--
93-94	4	2.4L	w/o O2 Sensor	4377 ③	6904 ③
13-15	4	2.5L	Manifold Unit, Front	1324 ③	--
07-15	4	2.5L	Rear, Exc. Hybrid	5024 ③	2575R ③
07-12	4	2.5L	Front	1169 ③	--
08-09	4	2.5L	Sedan, Rear	5012 ④①	2575R ③
2007	4	2.5L	Rear	5012 ④①	2575R ③
02-06	4	2.5L	Front, California Emissions	1195 ⑤	--
02-06	4	2.5L	Rear, California Emissions	4295 ⑤	2575R ⑤○
			Rear, California Emissions	--	2505R ⑤□
02-03	4	2.5L	Manifold Unit, Front	1201 ③	--
07-08	6	3.5L	Manifold Unit, Front	1236 ③	--
07-08	6	3.5L	Rear Manifold Conv.	1237 ③	--
07-08	6	3.5L	Rear Main Conv.	4606 ③	--
05-06	6	3.5L	Rear Manifold Conv.	1197 ③	--
04-06	6	3.5L	Rear Main Conv., Auto Trans., From 1/04	4438 ③	--
04-06	6	3.5L	Front Manifold Conv., Auto Trans., From 1/04	1126 ③	--
04-06	6	3.5L	Front Manifold Conv., Manual Trans., From 1/04	1196 ③	--

① Discontinued, use until inventory is depleted.

③ Federal & California Emissions. Not For Sale or Use on vehicles licensed in the state of CA & NY (NY vehicles with CA Emissions). Check with your state authority for details.

④ Federal Emissions. Not For Sale or Use on vehicles licensed in the state of CA. Check with your state authority.

⑤ California Emissions. Not For Sale or Use on vehicles licensed in the state of CA & NY. Check with your state authority.

188 □ EPA OBDII By Design Unit

○ EPA Enhanced OBDII By Design Unit

# APPLICATION LISTINGS

## FEDERAL CONVERTERS



YR/YRS	CYL	LITER	DESCRIPTION	DIRECT FIT	UNIVERSAL
<b>NISSAN ALTIMA (Cont.)</b>					
04-06	6	3.5L	Rear Main Conv., Manual Trans., From 1/04	4396 ③	2565R③
02-04	6	3.5L	Front Manifold Conv., To 1/04	1196 ③	--
02-04	6	3.5L	Rear Manifold Conv.	1197 ③	--
02-04	6	3.5L	Rear Main Conv., To 1/04	4396 ③	2565R③○
<b>NISSAN ARMADA</b>					
07-15	8	5.6L	Rear Right	4758 ③	2575③
07-15	8	5.6L	Rear Left	4005 ③	2575③
05-06	8	5.6L	Right Manifold Conv.	4739 ③	--
05-06	8	5.6L	Manifold Unit, Left	4738 ③	--
05-06	8	5.6L	Without Flex, US EPA, BIN 8, SULEV Emissions, Right Rear	4758 ③	2575③
05-06	8	5.6L	Without Flex, US EPA, BIN 8, SULEV Emissions, Left Rear	4759 ③	2575③
<b>NISSAN AXXESS VAN</b>					
1990	4	2.4L		4408 ③	6905③
<b>NISSAN B210, 210</b>					
80-82	4	1.2L		4408 ③	6905③
80-82	4	1.4L		4408 ③	6905③
80-82	4	1.5L		4408 ③	6905③
77-79	4	All	Federal Emissions	4377 ④	6904④
77-79	4	All	California Emissions	4408 ⑤	6905⑤
<b>NISSAN CUBE</b>					
11-14	4	1.8L	Federal Emissions	4607 ③	--
09-10	4	1.8L		4607 ③	--
<b>NISSAN FRONTIER</b>					
01-04	4	2.4L	Front	1109 ③	--
98-04	4	2.4L	Rear, w/ 13-1/2" Converter	4772 ③	2575③
00-03	4	2.4L		--	2504R③
05-16	4	2.5L	Manifold Unit, Front	1304 ③	--
02-04	6	3.3L	Front Right Manifold Conv.	1124 ③	--
02-04	6	3.3L	Front Left Manifold Conv.	1125 ③	--
99-04	6	3.3L	Main Right	4236 ③	2504③
99-04	6	3.3L	Main Left, w/ 26-3/4" Converter	4237 ③	2505③
99-04	6	3.3L	Main Left, w/ 41" Converter	4463 ③	--
99-01	6	3.3L	Front Right	1036 ③	--
99-01	6	3.3L	Front Left	1037 ③	--
2000	6	3.3L	From 1/00 To 9/00, Front Left	--	2504③
2000	6	3.3L	From 1/00 To 9/00, Front Right	--	2504③
05-10	6	4.0L	Left Front	4630 ③	--
05-10	6	4.0L	Right Front	4631 ③	--
05-10	6	4.0L	Right Rear	4632 ③	2575③
05-10	6	4.0L	Left Rear	4633 ③	2575③
<b>NISSAN JUKE</b>					
11-16	4	1.6L	FWD, Rear	5109 ③	--
<b>NISSAN MAXIMA</b>					
00-01	6	3.0L	Front, California Emissions	1014 ⑤	--
00-01	6	3.0L	Middle Conv., California Emissions	4014 ⑤	--
00-01	6	3.0L	Rear, California Emissions	4317 ⑤	2545⑤
95-00	6	3.0L	Main Conv., Federal Emissions	4841 ④	--

③ Federal & California Emissions. Not For Sale or Use on vehicles licensed in the state of CA & NY (NY vehicles with CA Emissions). Check with your state authority for details.

④ Federal Emissions. Not For Sale or Use on vehicles licensed in the state of CA. Check with your state authority.

⑤ California Emissions. Not For Sale or Use on vehicles licensed in the state of CA & NY. Check with your state authority.

○ EPA Enhanced OBDII By Design Unit

YR/YRS	CYL	LITER	DESCRIPTION	DIRECT FIT	UNIVERSAL
<b>NISSAN MAXIMA (Cont.)</b>					
1999	6	3.0L	California Emissions, Center	5155 ⑤	--
95-99	6	3.0L	Front, Federal Emissions	4941 ④	--
1994	6	3.0L	24 valve, 12-3/8" Conv.	4867 ③	--
1994	6	3.0L	24 valve, (Exc. 12-3/8" Conv.)	4408 ③	6905 ③
86-93	6	3.0L	Built from 1/86	4408 ③	6905 ③
85-86	6	3.0L	Rear, Built to 1/86	--	6906 ③
10-15	6	3.5L	Federal Emissions, Front Left	1321 ④	--
10-15	6	3.5L	Federal Emissions, Front Right	1322 ④	--
2009	6	3.5L	Front Left	1321 ③	--
2009	6	3.5L	Front Right	1322 ③	--
2009	6	3.5L	Center	5208 ③	--
07-08	6	3.5L	Manifold Unit, Front	1187 ③	--
04-08	6	3.5L	Rear Manifold Conv.	1197 ③	--
2006	6	3.5L	Rear Main Conv., SE w/ 5 Speed Auto Trans.	4438 ③	2565R ③ □
05-06	6	3.5L	Front Manifold Conv., Manual Trans.	1187 ③	--
05-06	6	3.5L	Front Manifold, Auto Trans.	1182 ③	--
05-06	6	3.5L	Rear Main Conv., Auto Trans.	4438 ③	2565R ③ ○
2004	6	3.5L	Front Manifold Conv., 5 Speed Auto. Trans.	1182 ③	--
2004	6	3.5L	Front Manifold Conv., Manual Trans.	1187 ③	--
2004	6	3.5L	Front Manifold Conv., 4 Speed Auto Trans.	1187 ③	--
2004	6	3.5L	Rear Main Conv., 5 Speed Auto Trans.	4438 ③	2565R ③ ○
02-03	6	3.5L	Front Pre-Cat Conv.	1078 ③	--
02-03	6	3.5L	Rear Pre-Cat Conv.	1079 ③	--
02-03	6	3.5L	Rear Main Conv.	4368 ③	--
<b>NISSAN MICRA</b>					
88-91	4	All	(Canada Model)	4377 ③	6804 ③
84-87	4	All	(Canada Model)	--	6004 ③
<b>NISSAN MULTI</b>					
1988	4	2.0L	(Canada Model)	--	6904 ③
86-87	4	2.0L	(Canada Model)	4408 ③	6905 ③
<b>NISSAN MURANO</b>					
09-12	6	3.5L	Rear	4007 ③	--
03-07	6	3.5L	Manifold Unit, Front	1196 ③	--
03-07	6	3.5L	Rear Manifold Conv.	1137 ③	--
03-07	6	3.5L	Rear Main	4437 ③	2565 ③ ○
<b>NISSAN NX</b>					
91-93	4	All		4408 ③	6905 ③
<b>NISSAN PATHFINDER</b>					
87-88	4	2.4L	w/Air Tube	--	6005 ③
1995	6	3.0L	Front	--	6904R ③
1995	6	3.0L		--	6905 ③
90-94	6	3.0L		4588 ③	6905 ③
87-89	6	3.0L	w/Air Tube	--	6005 ③
98-00	6	3.3L	Rear Right, California Emissions	4318 ⑤	2504 ⑤
98-00	6	3.3L	Rear Left, California Emissions	4319 ⑤	2504 ⑤
96-00	6	3.3L	Front, Right	1016 ③	--
96-00	6	3.3L	Front, Left	1015 ③	--

③ Federal & California Emissions. Not For Sale or Use on vehicles licensed in the state of CA & NY (NY vehicles with CA Emissions). Check with your state authority for details.

④ Federal Emissions. Not For Sale or Use on vehicles licensed in the state of CA. Check with your state authority.

⑤ California Emissions. Not For Sale or Use on vehicles licensed in the state of CA & NY. Check with your state authority.

□ EPA OBDII By Design Unit

○ EPA Enhanced OBDII By Design Unit

# APPLICATION LISTINGS

## FEDERAL CONVERTERS



YR/YRS	CYL	LITER	DESCRIPTION	DIRECT FIT	UNIVERSAL
<b>NISSAN PATHFINDER (Cont.)</b>					
01-04	6	3.5L	Front Right	1118 ③	--
01-04	6	3.5L	Front Left	1015 ③	--
2001	6	3.5L	Rear Right	4318 ③	2504 ③
2001	6	3.5L	Rear Left	4319 ③	2504 ③
05-10	6	4.0L	Right Front	4631 ③	--
05-10	6	4.0L	Left Front	4630 ③	--
05-10	6	4.0L	Right Rear	4632 ③	2575 ③
05-10	6	4.0L	Left Rear	4633 ③	2575 ③
2004	8	5.6L	Right Manifold Conv.	4739 ③	--
2004	8	5.6L	Manifold Unit, Left	4738 ③	--
<b>NISSAN PICKUP</b>					
1983	4	2.0L		4408 ③	6005 ③
1980	4	2.0L		4408 ③	6005 ③
81-83	4	2.2L		4408 ③	6005 ③
96-97	4	2.4L	w/ 16" Converter	4588 ③	2505 ③
96-97	4	2.4L	w/ 13-1/2" Converter	4772 ③	2575 ③
1995	4	2.4L	4WD	4588 ③	6905 ③
1995	4	2.4L	2WD	4087 ③	2906 ③
93-94	4	2.4L	2WD, Federal Emissions	4087 ④	6906 ④
90-94	4	2.4L	4WD	4377 ③	6904 ③
90-92	4	2.4L	2WD	4087 ③	6906 ③
88-89	4	2.4L	w/Air Tube, 4WD	--	6005 ③
88-89	4	2.4L	w/o Air Tube, 2WD, 2-1/2" Pipe	4087 ③	6906 ③
88-89	4	2.4L	w/o Air Tube, 2WD, 2-1/4" Pipe	4408 ③	6905 ③
86-87	4	2.4L	D21 (Hardbody) Pickup	4408 ③	6005 ③
83-86	4	2.4L	720 Pickup	4377 ③	6904 ③
94-95	6	3.0L	4WD, Front	--	6904R ③
94-95	6	3.0L	4WD, Rear	--	6905 ③
94-95	6	3.0L	2WD	4408 ③	6905 ③
90-93	6	3.0L		4408 ③	6905 ③
86-89	6	3.0L	w/Air Tube	--	6005 ③
86-89	6	3.0L	w/o Air Tube	4408 ③	6905 ③
<b>NISSAN PULSAR</b>					
88-90	4	All		4408 ③	6905 ③
1987	4	All	(Exc. 16 valve)	4408 ③	6905 ③
1987	4	All	w/16 valve	--	6905 ③
83-86	4	All	w/o Air Tube	4408 ③	6905 ③
83-86	4	All	w/Air Tube	--	6005 ③
<b>NISSAN QUEST</b>					
96-98	6	3.0L	Front	4587 ③	2564R ③
96-98	6	3.0L		4588 ③	2505 ③
94-95	6	3.0L	Front	4587 ③	6905R ③
94-95	6	3.0L		4588 ③	6905 ③
1993	6	3.0L		4588 ③	6905 ③
01-02	6	3.3L	Manifold Unit, Front Left	9500 ③①	--
			Manifold Unit, Front Left	1291 ③	--
99-02	6	3.3L	Rear	4588 ③	2505 ③

① Discontinued, use until inventory is depleted.

③ Federal & California Emissions. Not For Sale or Use on vehicles licensed in the state of CA & NY (NY vehicles with CA Emissions). Check with your state authority for details.

④ Federal Emissions. Not For Sale or Use on vehicles licensed in the state of CA. Check with your state authority.

YR/YRS	CYL	LITER	DESCRIPTION	DIRECT FIT	UNIVERSAL
<b>NISSAN QUEST (Cont.)</b>					
99-00	6	3.3L	California Emissions, Manifold Unit, Front Left	1291 ⑤	--
07-09	6	3.5L	Rear Main Conv.	4438 ③	2565R③○
07-09	6	3.5L	Front Manifold Conv., Auto Trans.	1182 ③	--
04-09	6	3.5L	Rear Manifold Conv.	1197 ③	--
04-06	6	3.5L	Front Manifold Conv., 5 Speed Auto. Trans.	1182 ③	--
04-06	6	3.5L	Rear Main Conv., w/ 5 Speed Auto Trans.	4438 ③	2565R③○
04-06	6	3.5L	Front Manifold Conv., 4 Speed Auto Trans.	1187 ③	--
04-06	6	3.5L	Rear Main Conv., 4 Speed Auto Trans.	4396 ③	2565R③
<b>NISSAN ROGUE</b>					
08-13	4	2.5L	Rear	4013 ③	2575R③
08-13	4	2.5L	Manifold Unit, Front	1325 ③	--
<b>NISSAN ROGUE SELECT</b>					
14-15	4	2.5L	Federal Emissions, Manifold Unit, Front	1325 ④	--
14-15	4	2.5L	Federal Emissions, Rear	4013 ④	2575R③
<b>NISSAN SENTRA</b>					
97-99	4	1.6L	GLE, GXE, XE Models	4058 ③	--
95-96	4	1.6L	Front, GLE, GXE, XE Models, California Emissions	4058 ⑤	--
95-96	4	1.6L	Rear, w/O2 Sensor in Conv. Outlet	4841 ③	--
91-95	4	1.6L	w/O2 Sensor in Conv. Inlet	4867 ③	--
91-94	4	1.6L		--	6905③
87-90	4	1.6L	w/ Fuel Injection, (Exc. 4WD)	4408 ③	6905③
87-88	4	1.6L	w/Carb., 4WD	--	6005③
03-06	4	1.8L	Front	1043 ③	--
03-06	4	1.8L		4343 ③	2504③
2002	4	1.8L		4317 ③	--
00-02	4	1.8L	Manifold Conv., Exc. CA (Clean Air) Models	4356 ③	--
00-01	4	1.8L	Rear, California Emissions	4317 ③	--
09-12	4	2.0L	Federal Emissions	5104 ③	--
09-12	4	2.0L	California Emissions, Manifold Unit, Front	1329 ⑤	--
09-12	4	2.0L	California Emissions, Rear	5203 ⑤	--
07-08	4	2.0L		5104 ③	--
00-01	4	2.0L	Rear, From 01/00	4317 ③	--
98-00	4	2.0L	To 12/99	4481 ③	2505③
91-94	4	2.0L	w/O2 Sensor in Conv. Inlet	4867 ③	--
02-06	4	2.5L	Manifold Unit, Front	1201 ③	--
			Manifold Unit, Front	1195 ③	--
02-03	4	2.5L	Rear, Built to 04/03	4460 ③	--
82-86	4	All	Underbody	4408 ③	6905③
<b>NISSAN STANZA</b>					
82-84	4	2.0L		4408 ③	6905③
1992	4	2.4L		4408 ③	6905③
90-91	4	2.4L		4377 ③	6904③
85-89	4	All	w/2-1/4" Pipe, w/o Air Tube, (Exc. Station Wgn. or Van)	4408 ③	6905③
85-89	4	All	w/2-1/2" Pipe, w/o Air Tube, (Exc. Station Wgn. or Van)	--	6906③
86-88	4	All	Station Wgn. or Van, w/Air Tube	--	6005③

③ Federal & California Emissions. Not For Sale or Use on vehicles licensed in the state of CA & NY (NY vehicles with CA Emissions). Check with your state authority for details.

④ Federal Emissions. Not For Sale or Use on vehicles licensed in the state of CA. Check with your state authority.

⑤ California Emissions. Not For Sale or Use on vehicles licensed in the state of CA & NY. Check with your state authority.

○ EPA Enhanced OBDII By Design Unit

# APPLICATION LISTINGS

## FEDERAL CONVERTERS



YR/YRS	CYL	LITER	DESCRIPTION	DIRECT FIT	UNIVERSAL
<b>NISSAN TITAN</b>					
07-15	8	5.6L	Rear Right	4758 ③	2575③
07-15	8	5.6L	Rear Left	4005 ③	2575③
04-06	8	5.6L	Right Manifold Conv.	4739 ③	--
04-06	8	5.6L	Manifold Unit, Left	4738 ③	--
04-06	8	5.6L	Without Flex, US EPA, BIN 8, SULEV Emissions, Right Rear	4758 ③	2575③
04-06	8	5.6L	Without Flex, US EPA, BIN 8, SULEV Emissions, Left Rear	4759 ③	2575③
<b>NISSAN VAN</b>					
87-88	4	2.4L		--	6005③
<b>NISSAN VERSA</b>					
09-11	4	1.6L		4432 ③	2574R③○
07-12	4	1.8L		4432 ③	2574R③○
<b>NISSAN X-TRAIL</b>					
07-08	4	2.5L	Manifold Unit, Front	1325 ③	--
<b>NISSAN XTERRA</b>					
01-04	4	2.4L	Front	1109 ③	--
00-04	4	2.4L		4317 ③	2545③
02-04	6	3.3L	Front Right Manifold Conv.	1124 ③	--
02-04	6	3.3L	Front Left Manifold Conv.	1125 ③	--
00-04	6	3.3L	Main Right	4236 ③	2504③
00-04	6	3.3L	Main Left, w/ 26-3/4" Converter	4237 ③	2504③
00-04	6	3.3L	Main Left, w/ 41" Converter	4463 ③	--
00-01	6	3.3L	Front Right	1036 ③	--
00-01	6	3.3L	Front Left	1037 ③	--
2000	6	3.3L	From 1/00 To 9/00, Front Left	--	2504③
2000	6	3.3L	From 1/00 To 9/00, Front Right	--	2504③
05-10	6	4.0L	Right Front	4631 ③	--
05-10	6	4.0L	Left Front	4630 ③	--
05-10	6	4.0L	Left Rear	4633 ③	2575③
05-10	6	4.0L	Right Rear	4632 ③	2575③
<b>OLDSMOBILE 98</b>					
1985	6	3.0L		--	6004③
95-96	6	3.8L	Code "K" & "L" Eng., 1st Design Front Pipe & Conv. are 1 Piece, Additional sizing, bushings, cutting may be required due to OE exhaust design, # 3 bushing may be required.	4975 ②③	2505R③
1995	6	3.8L		--	6905③
92-94	6	3.8L	For use with OE intermediate pipe, additional sizing, bushings, cutting may be required due to OE exhaust design, # 3 bushing may be required.	4646 ②③	6906③
92-94	6	3.8L		--	6906③
1991	6	3.8L	Additional sizing, bushings, cutting may be required due to OE exhaust design.	4646 ②③	6906③
88-90	6	3.8L	For use with OE intermediate pipe, # 6 bushing may be required with aftermarket pipe.	4120 ②③	6905③
88-90	6	3.8L	For use with 2-3/8" I.D. aftermarket intermediate pipe.	4120G ③	6905③
86-87	6	3.8L	For use with OE intermediate pipe.	4501 ②③	6905③
86-87	6	3.8L	For use w/2-3/8" I.D. aftermarket intermediate piping.	--	6905③
1985	6	3.8L		--	6004③

② When using with aftermarket piping, direct fit converter may require INLET/OUTLET pipe resizing.

③ Federal & California Emissions. Not For Sale or Use on vehicles licensed in the state of CA & NY (NY vehicles with CA Emissions). Check with your state authority for details.

○ EPA Enhanced OBDII By Design Unit



YR/YRS	CYL	LITER	DESCRIPTION	DIRECT FIT	UNIVERSAL
<b>OLDSMOBILE 98 (Cont.)</b>					
81-83	6	4.1L		4111 ☆③	6005③
1984	8	5.0L		4119 ☆③	6005③
81-83	8	5.0L		4111 ☆③	6005③
1980	8	5.0L		--	6905③
1980	8	5.7L		--	6905③
77-79	8	5.7L		--	6906③
1975	8	6.6L		--	8006③
75-76	8	7.5L		--	8006③
<b>OLDSMOBILE ACHIEVA</b>					
93-95	4	2.3L	Quad 4	4719 ③	6904R③
93-94	4	2.3L	Code "3", Semi Direct Fit Conv. Must Reuse Front Pipe.	--	6905③
1992	4	2.3L	Code "3" Eng.	--	6903③
1992	4	2.3L	Quad 4, Code "D" Eng.	--	6905③
96-98	4	2.4L	Auto Trans.	4823 ③	2504R③
96-97	4	2.4L	Manual Trans.	4220 ③	2505R③
1998	6	3.1L	W/Flat Gasket at Manifold	4831 ③	2505R③
97-98	6	3.1L	W/Steel Crush Ring Gasket at Manifold	4849 ③	2504R③
1996	6	3.1L		4862 ③	2504R③
94-95	6	3.1L	Conv. w/Front Pipe	4793 ③	6904③
94-95	6	3.1L	Semi Direct Fit Conv. Must Reuse Front Pipe	--	6904③
92-93	6	3.3L		4589 ③	6905③
<b>OLDSMOBILE ALERO</b>					
02-04	4	2.2L		4205 ③	2504R③
99-01	4	2.4L		4877 ③	2505R③
99-04	6	3.4L		4863 ③	2505R③
<b>OLDSMOBILE AURORA</b>					
01-02	6	3.5L	Use w/OE Pipe, Includes Resonator	9035 ③	--
01-03	8	4.0L	Use w/OE Pipe, Includes Resonator	9035 ③	--
96-99	8	4.0L	Models w/4 Bolt Flange Inlet, 2nd design front pipe & conv. separate, for use with OE intermediate pipe, additional sizing, bushings, cutting may be required due to OE exhaust design, # 3 bushing may be required.	4890 ②③	2516③
				--	--
				--	--
96-99	8	4.0L	Models w/4 Bolt Flange Inlet, 2nd design front pipe & conv. separate, for use with aftermarket intermediate pipe, additional sizing, bushings, cutting may be required due to OE exhaust design.	4890G ②③	2516③
				--	--
				--	--
1995	8	4.0L		4370 ③	2506R③
<b>OLDSMOBILE BRAVADA</b>					
02-04	6	4.2L		9154 ③	2516③
00-01	6	4.3L	California Emissions	9109 ⑤	--
00-01	6	4.3L	Front, California Emissions	--	2576R⑤
00-01	6	4.3L	Rear, California Emission	--	2517⑤
2000	6	4.3L	Federal Emissions	9108 ④	2517④
98-99	6	4.3L	Front, California Emissions	1192 ⑤	2538⑤
98-99	6	4.3L	Rear	4792 ③	2516③
96-97	6	4.3L		4792 ③	2516③
92-94	6	4.3L	Code "W"	4880 ③	2906③
91-92	6	4.3L	Code "Z"	4088 ③	2906③

☆ Air Tube kit 4948 may be required for installation.

② When using with aftermarket piping, direct fit converter may require INLET/OUTLET pipe resizing.

③ Federal & California Emissions. Not For Sale or Use on vehicles licensed in the state of CA & NY (NY vehicles with CA Emissions). Check with your state authority for details.

④ Federal Emissions. Not For Sale or Use on vehicles licensed in the state of CA. Check with your state authority.

194 ⑤ California Emissions. Not For Sale or Use on vehicles licensed in the state of CA & NY. Check with your state authority.

# APPLICATION LISTINGS

## FEDERAL CONVERTERS



YR/YRS	CYL	LITER	DESCRIPTION	DIRECT FIT	UNIVERSAL
<b>OLDSMOBILE CALAIS</b>					
90-91	4	2.3L		--	6905③
88-89	4	2.3L		--	6905③
90-91	4	2.5L		4595 ③	6904③
90-91	4	2.5L	Optional Direct Fit Converter	--	6904③
85-89	4	2.5L	Additional sizing, bushings, cutting may be required due to OE exhaust design, Two # 8 bushings may be required.	4117 ②③	6904③
85-88	6	3.0L	Additional sizing, bushings, cutting may be required due to OE exhaust design, Two # 8 bushings may be required.	4117 ②③	6904③
90-91	6	3.3L		4589 ③	6905③
1989	6	3.3L		--	6905R③
<b>OLDSMOBILE CIERA</b>					
1996	4	2.2L	Ciera & Ciera Cruiser	4789 ③	2505R③
93-95	4	2.2L	Ciera & Ciera Cruiser	4789 ③	6904R③
86-92	4	2.5L	Conv. Only w/o Front Pipe	4155 ☆②③	6004③
86-92	4	2.5L	Conv. w/Front Pipe	4076 ③	6004③
82-85	4	2.5L		--	6004③
86-89	6	2.8L	Conv. Only w/o Front Pipe	4155 ☆②③	6004③
86-89	6	2.8L	Conv. w/Front Pipe	--	6004③
1996	6	3.1L		4229 ③	2505R③
94-95	6	3.1L		4229 ③	6905R③
89-93	6	3.3L		4419 ③	6905③
86-88	6	3.8L	Conv. Only w/o Front Pipe	4155 ☆②③	6004③
86-88	6	3.8L	Conv. w/Front Pipe, w/o Air Tube	--	6904③
82-85	6	All		--	6004③
<b>OLDSMOBILE CUTLASS</b>					
90-91	4	2.3L	For use with OE intermediate pipe, additional sizing, bushings, cutting may be required due to OE exhaust design, # 6 bushing may be required at inlet & # 8 bushing may be required at outlet for use w/aftermarket pipe.	4137 ②③	6905③
90-91	4	2.3L	For use w/2-1/8" I.D. aftermarket intermediate piping, additional sizing, bushings, cutting may be required due to OE exhaust design.	4137G ②③	6905③
88-89	6	2.8L	For use with OE intermediate pipe, additional sizing, bushings, cutting may be required due to OE exhaust design, # 6 bushing may be required at inlet & # 8 bushing may be required at outlet for use w/aftermarket pipe.	4137 ②③	6905③
88-89	6	2.8L	For use w/2-1/8" I.D. aftermarket intermediate piping, additional sizing, bushings, cutting may be required due to OE exhaust design.	4137G ②③	6905③
98-99	6	3.1L		4863 ③	2505R③
1997	6	3.1L	Supreme	4874 ③	2505R③
1997	6	3.1L		--	2505R③
1996	6	3.1L		--	2505R③
95-96	6	3.1L	Models w/Post Conv. O2 Sensor	4838 ③	2505R③
94-95	6	3.1L	(Exc. Models w/Post Conv. O2 Sensor)	4629 ③	6904R③
90-93	6	3.1L	Supreme, Dual Exhaust	4141 ③	2904③

☆ Air Tube kit 4948 may be required for installation.

② When using with aftermarket piping, direct fit converter may require INLET/OUTLET pipe resizing.

③ Federal & California Emissions. Not For Sale or Use on vehicles licensed in the state of CA & NY (NY vehicles with CA Emissions). Check with your state authority for details.

YR/YRS	CYL	LITER	DESCRIPTION	DIRECT FIT	UNIVERSAL
<b>OLDSMOBILE CUTLASS (Cont.)</b>					
89-93	6	3.1L	(Exc. Dual Exhaust), For use with OE intermediate pipe, additional sizing, bushings, cutting may be required due to OE exhaust design, # 6 bushing may be required at inlet & # 8 bushing may be required at outlet for use w/aftermarket pipe.	4137 ②③ -- -- --	6905③ -- -- --
89-93	6	3.1L	(Exc. Dual Exhaust), For use w/2-1/8" I.D. aftermarket intermediate piping, additional sizing, bushings, cutting may be required due to OE exhaust design.	4137G ②③ -- --	6905③ -- --
1996	6	3.4L		4898 ③	2506R③
91-95	6	3.4L		4779 ③	6906③
83-87	6	3.8L		4112 ☆③	6005③
1983	6	3.8L	California Emissions	4111 ☆⑤	6005⑤
81-82	6	3.8L		--	6005③
1980	6	3.8L		--	6906③
78-79	6	3.8L		4111 ☆③	6005③
1977	6	3.8L		--	6906③
75-76	6	4.1L		--	6906③
81-82	8	4.3L		4111 ☆③	6005③
1980	8	4.3L		--	6005③
78-79	8	4.3L		4111 ☆③	6005③
75-77	8	4.3L		--	6906③
83-88	8	5.0L		4112 ☆③	6005③
81-82	8	5.0L		4111 ☆③	6005③
1980	8	5.0L		--	6906③
78-79	8	5.0L	(Exc. '78 305 C.I.D., w/2 bbl Carb.)	--	6906③
1978	8	5.0L	w/2 bbl Carb.	--	6005③
1980	8	5.7L		--	6906③
78-79	8	5.7L		--	6906③
75-77	8	5.7L		--	6906③
1977	8	6.6L		--	8006③
1976	8	7.5L		--	8006③
<b>OLDSMOBILE EIGHTY-EIGHT, DELTA 88</b>					
1986	6	3.0L	For use with OE intermediate pipe.	4501 ②③	6905③
1986	6	3.0L	For use with 2-3/8" I.D. aftermarket intermediate pipe.	--	6905③
97-99	6	3.8L	Models w/4 Bolt Flange Inlet, front pipe & conv. separate, for use with OE intermediate pipe, additional sizing, bushings, cutting may be required due to OE exhaust design, # 3 bushing may be required.	4890 ②③ -- -- --	2516③ -- -- --
97-99	6	3.8L	Models w/4 Bolt Flange Inlet, front pipe & conv. separate, for use with aftermarket intermediate pipe, additional sizing, bushings, cutting may be required due to OE exhaust design.	4890G ②③ -- --	2516③ -- --
95-96	6	3.8L	Front Pipe & Conv. are 1 Piece, Code "K" Eng., Additional sizing, bushings, cutting may be required due to OE exhaust design, # 3 bushing may be required.	4975 ②③ -- --	2516③ -- --
92-94	6	3.8L	For use with OE intermediate pipe, additional sizing, bushings, cutting may be required due to OE exhaust design, # 3 bushing may be required.	4646 ②③ -- --	6906③ -- --
92-94	6	3.8L		4646G ②③	6906③

☆ Air Tube kit 4948 may be required for installation.

② When using with aftermarket piping, direct fit converter may require INLET/OUTLET pipe resizing.

③ Federal & California Emissions. Not For Sale or Use on vehicles licensed in the state of CA & NY (NY vehicles with CA Emissions). Check with your state authority for details.

⑤ California Emissions. Not For Sale or Use on vehicles licensed in the state of CA & NY. Check with your state authority.

# APPLICATION LISTINGS

## FEDERAL CONVERTERS



YR/YRS	CYL	LITER	DESCRIPTION	DIRECT FIT	UNIVERSAL
<b>OLDSMOBILE EIGHTY-EIGHT, DELTA 88 (Cont.)</b>					
88-91	6	3.8L	For use with OE intermediate pipe, additional sizing, bushings, cutting may be required due to OE exhaust design, # 6 bushing may be required with aftermarket pipe.	4120 ②③ -- --	6905③ -- --
88-91	6	3.8L	For use with 2-3/8" I.D. aftermarket intermediate pipe.	4120G ③	6905③
86-87	6	3.8L	For use with OE intermediate pipe.	4501 ②③	6905③
86-87	6	3.8L	For use with 2-3/8" I.D. aftermarket intermediate pipe.	--	6905③
77-79	6	3.8L		--	6906③
83-84	6	All		4112 ☆③	6905③
81-82	6	All		4111 ☆③	6005③
1980	6	All	w/o Air Tube	--	6906③
1980	6	All	w/Air Tube	--	6006③
84-90	8	5.0L	Station Wgn.	--	2905③
84-90	8	5.0L	Optional Direct Fit Converter	4119 ☆③	6005③
84-85	8	5.0L	(Exc. Station Wgn.)	4119 ☆③	6005③
81-83	8	5.0L		4111 ☆③	6005③
1980	8	5.7L	Code "R"	--	6005③
75-76	8	7.5L		--	8006③
77-79	8	All		--	6906③
75-76	8	All	(Exc. 455 C.I.D.)	--	6906③
<b>OLDSMOBILE FIRENZA</b>					
82-86	4	All		--	6003③
1987	6	2.8L	Additional sizing, bushings, cutting may be required due to OE exhaust design.	4117 ②③ --	6904③ --
85-86	6	2.8L		--	6904③
<b>OLDSMOBILE INTRIGUE</b>					
99-02	6	3.5L		4234 ③	2505R③
98-99	6	3.8L	Code "K" Eng. Code "K" Eng.	4876 ③ --	2576R③○ 2504R③□
<b>OLDSMOBILE OMEGA</b>					
82-84	4	2.5L		--	6004③
1981	4	2.5L		--	6003③
1980	4	2.5L		--	6004③
83-84	6	2.8L		--	6004③
1982	6	2.8L	(Exc. Code "Z" Eng.)	--	6004③
1982	6	2.8L	Code "Z" Eng.	4303 ☆③	6005③
1981	6	2.8L		--	6003③
1980	6	2.8L		--	6004③
75-79	6,8	All		--	6905③
<b>OLDSMOBILE REGENCY</b>					
97-98	6	3.8L	Models w/4 Bolt Flange Inlet, front pipe & conv. separate, for use with OE intermediate pipe, additional sizing, bushings, cutting may be required due to OE exhaust design, # 3 bushing may be required.	4890 ②③ -- -- --	2516③ -- -- --
97-98	6	3.8L	Models w/4 Bolt Flange Inlet, front pipe & conv. separate, for use with aftermarket intermediate pipe, additional sizing, bushings, cutting may be required due to OE exhaust design.	4890G ②③ -- --	2516③ -- --

☆ Air Tube kit 4948 may be required for installation.

② When using with aftermarket piping, direct fit converter may require INLET/OUTLET pipe resizing.

③ Federal & California Emissions. Not For Sale or Use on vehicles licensed in the state of CA & NY (NY vehicles with CA Emissions). Check with your state authority for details.

□ EPA OBDII By Design Unit

○ EPA Enhanced OBDII By Design Unit

YR/YRS	CYL	LITER	DESCRIPTION	DIRECT FIT	UNIVERSAL
<b>OLDSMOBILE SILHOUETTE</b>					
93-94	6	3.1L		4242 ③	2905③
90-92	6	3.1L	Conv., w/Front Pipe	--	2905③
90-92	6	3.1L	Conv. Only	--	2905③
02-04	6	3.4L	FWD	4307 ③	2516③
2001	6	3.4L		4327 ③	2516③
97-00	6	3.4L		4133 ③	2505R③
1996	6	3.4L		4781 ③	2516③
93-95	6	3.8L		4873 ③	2905③
<b>OLDSMOBILE STARFIRE</b>					
77-80	4	All		--	6905③
75-80	6,8	All		--	6905③
<b>OLDSMOBILE TORONADO</b>					
91-92	6	3.8L	For use with OE intermediate pipe, additional sizing, bushings, cutting may be required due to OE exhaust design.	--	6006③
91-92	6	3.8L		--	6006③
88-90	6	3.8L	Additional sizing, bushings, cutting may be required due to OE exhaust design, two # 6 bushings may be required (1 at inlet & 1 at outlet).	--	6904③
86-87	6	3.8L	For use with OE intermediate pipe, # 6 bushing may be required with aftermarket pipe.	4120 ②③	6905③
86-87	6	3.8L	For use with 2-3/8" I.D. aftermarket intermediate pipe.	4120G ③	6905③
1984	6	4.1L		4112 ☆③	6005③
81-83	6	4.1L		4111 ☆③	6005③
84-85	8	5.0L		4119 ☆③	6005③
81-83	8	5.0L		4111 ☆③	6005③
1980	8	5.7L	Code "R"	--	6905③
77-79	8	5.7L		--	6906③
77-78	8	6.6L		--	8006③
75-76	8	7.5L		--	8006③
<b>OPEL OPEL</b>					
76-78	4	1.8L		4175 ③	6906③
<b>PASSPORT I-MARK</b>					
85-89	4	1.5L	Rear, (Canada Model)	--	6906③
85-89	4	1.5L	Optional Direct Fit Converter (Canada Model)	4175 ③	--
<b>PASSPORT IMPULSE</b>					
90-92	4	1.6L	Rear, (Canada Model)	--	6906③
90-92	4	1.6L	Optional Direct Fit Converter (Canada Model)	4175 ③	--
<b>PASSPORT OPTIMA</b>					
88-91	4	1.6L	(Canada Model)	--	6904③
89-91	4	2.0L	(Canada Model)	--	6905③
<b>PASSPORT STYLUS</b>					
91-93	4	1.6L	(Canada Model)	4175 ③	6906③
<b>PEUGEOT 405</b>					
89-91	4	All	w/O2 Sensor in Pipe, Semi-Direct Fit, fabrication required	--	6905③
<b>PEUGEOT 504</b>					
77-79	4	2.0L		--	6903③

☆ Air Tube kit 4948 may be required for installation.

② When using with aftermarket piping, direct fit converter may require INLET/OUTLET pipe resizing.

③ Federal & California Emissions. Not For Sale or Use on vehicles licensed in the state of CA & NY (NY vehicles with CA Emissions). Check with your state authority for details.

# APPLICATION LISTINGS

## FEDERAL CONVERTERS



YR/YRS	CYL	LITER	DESCRIPTION	DIRECT FIT	UNIVERSAL
<b>PEUGEOT 505</b>					
80-85	4	2.0L	w/28-3/4" Conv., (Exc. Turbo)	--	6903③
80-83	4	2.0L	21" Conv., (Exc. Turbo)	--	6904③
1991	4	2.2L		--	6904③
87-90	4	2.2L	Turbo Station Wgn.	--	6905③
87-89	6	2.8L		--	6905③
<b>PEUGEOT 604</b>					
77-78	6	2.7L	Left	--	6904R③
77-78	6	2.7L	Right	--	6904R③
79-81	6	2.8L		--	6904③
<b>PLYMOUTH ACCLAIM</b>					
90-95	4	2.5L	(Exc. Turbo)	4051 ☆③	6004③
1990	4	2.5L	Turbo	--	6005③
1989	4	2.5L	(Exc. Turbo), w/Auto Trans.	4051 ③	6004③
92-95	6	3.0L		4875 ③	6905③
89-91	6	3.0L	Conv. includes Resonator	4223 ③	6905③
<b>PLYMOUTH ARROW</b>					
78-80	4	All		--	6903③
<b>PLYMOUTH ARROW PICKUP</b>					
79-82	4	All		--	6904③
<b>PLYMOUTH B-VAN</b>					
80-83	6	3.7L	Underbody	--	2904③
75-79	6	3.7L	2" Outlet	--	6905③
80-83	8	5.2L	Underbody	--	2906③
80-83	8	5.2L	Main & Pre-Cat	--	2906③
80-83	8	5.9L	Underbody	--	2906③
80-83	8	5.9L	Main & Pre-Cat	--	2906③
80-81	8	All	w/o Pre-Cat	--	2905③
75-79	8	All		--	9006③
<b>PLYMOUTH BREEZE</b>					
98-00	4	2.0L		4225 ③	2504③
96-97	4	2.0L		4128 ③	2540③
98-00	4	2.4L		4859 ③	2540③
<b>PLYMOUTH CARAVELLE</b>					
1988	4	2.2L	Auto Trans., Built After 10/12/87, (Exc. Turbo)	4775 ☆③	6004③
87-88	4	2.2L	Turbo	--	6906③
1986	4	2.2L	Turbo	--	6905③
1986	4	2.2L	Auto Trans., (Exc. Turbo)	--	6004③
1985	4	2.2L	(Exc. Turbo)	--	6004③
1985	4	2.2L	Turbo	--	6905③
87-88	4	2.5L		4775 ☆③	6004③
1986	4	2.5L		4775 ☆③	6004③
1985	4	2.6L		--	6904③
<b>PLYMOUTH CHAMP</b>					
81-82	4	All	Rear	--	6904③
81-82	4	All	Main & Pre-Cat	--	6004③
79-80	4	All		--	6904③

☆ Air Tube kit 4948 may be required for installation.

③ Federal & California Emissions. Not For Sale or Use on vehicles licensed in the state of CA & NY (NY vehicles with CA Emissions). Check with your state authority for details.

YR/YRS	CYL	LITER	DESCRIPTION	DIRECT FIT	UNIVERSAL
<b>PLYMOUTH COLT</b>					
81-84	4	1.4L		--	6904③
89-91	4	1.5L		4377 ③	6904③
87-88	4	1.5L		4203 ③	6904R③
85-86	4	1.5L	Rear	--	6904③
89-90	4	1.6L		4377 ③	6904③
87-88	4	1.6L		4203 ③	6904R③
81-86	4	1.6L		--	6904③
89-90	4	1.8L		--	6904③
89-91	4	2.0L	Vista	4377 ③	6904③
87-88	4	2.0L	Vista, Built After 12/86	4377 ③	6904③
1987	4	2.0L	Vista, Built Before 12/86	--	6904③
84-86	4	2.0L	Vista	--	6904③
92-94	4	All	Includes Vista	4377 ③	6904③
<b>PLYMOUTH CONQUEST</b>					
84-86	4	2.6L	Turbo, Rear	--	6904③
<b>PLYMOUTH DUSTER</b>					
75-76	6	3.7L		--	6904③
75-76	8	All		--	6905③
<b>PLYMOUTH EXPO</b>					
87-89	4	2.2L	(Canada Model)	--	6004③
<b>PLYMOUTH FURY, GRAN FURY</b>					
81-83	6	3.7L	Underbody	--	6004③
81-83	6	3.7L	Main & Pre-Cat	--	6004③
1980	6	3.7L	4 Dr., Rear	--	6004③
1980	6	3.7L	4 Dr., Main & Pre-Cat	--	6004③
1978	6	3.7L	2 Dr.	--	6905③
1978	6	3.7L	4 Dr. or Station Wgn.	--	6905③
81-89	8	5.2L	Underbody	--	6005③
81-89	8	5.2L	Main & Pre-Cat	--	6005③
1980	8	5.2L	4 Dr. or Station Wgn.	--	6905③
1980	8	5.2L	California Emissions	--	6905⑤
77-78	8	5.2L	2 Dr.	--	6905③
77-78	8	5.2L	4 Dr. or Station Wgn.	--	6905③
75-76	8	5.2L		--	2906③
1978	8	5.9L	2 Dr.	--	6905③
1978	8	5.9L	4 Dr. or Station Wgn.	--	6905③
75-76	8	5.9L		--	2906③
75-78	8	6.6L		--	2906③
75-76	8	7.2L	Single Exhaust	--	9006③
75-76	8	7.2L	Left, Dual Exhaust	--	9006③
75-76	8	7.2L	Right, Dual Exhaust	--	9006③
<b>PLYMOUTH HORIZON</b>					
83-86	4	1.6L	Front	--	6004③
83-84	4	1.6L		--	6904③
82-83	4	1.7L	Front	--	6004③
82-83	4	1.7L		--	6904③
1981	4	1.7L	Front	--	6004③

③ Federal & California Emissions. Not For Sale or Use on vehicles licensed in the state of CA & NY (NY vehicles with CA Emissions). Check with your state authority for details.

⑤ California Emissions. Not For Sale or Use on vehicles licensed in the state of CA & NY. Check with your state authority.

**APPLICATION LISTINGS**  
**FEDERAL CONVERTERS**



YR/YRS	CYL	LITER	DESCRIPTION	DIRECT FIT	UNIVERSAL
<b>PLYMOUTH HORIZON (Cont.)</b>					
80-81	4	1.7L		--	6004③
1980	4	1.7L	Front Mini-Ox Conv.	--	6904R③
78-79	4	1.7L		--	6004③
88-90	4	2.2L	Semi-Direct Fit, fabrication required - Outlet Pipe	--	6004③
81-87	4	2.2L	Front	--	6004③
81-82	4	2.2L		--	6004③
<b>PLYMOUTH LASER</b>					
90-94	4	All		4377 ③	6904③
<b>PLYMOUTH NEON</b>					
00-01	4	2.0L	w/2-1/4" OD Outlet, Exc. ULEV	4094 ③	2505R③
00-01	4	2.0L	w/2" OD Outlet, Federal Emissions TLEV, Exc. ULEV	4094G ④	2505R④
00-01	4	2.0L	ULEV, VIN C, Rear	5148 ③	--
98-99	4	2.0L	OBDII Equipped, Federal Emissions, Exc. LEV	4651 ④	2505④
95-97	4	2.0L	OBDII Equipped, Federal Emissions	4651 ④	2505④
<b>PLYMOUTH PROWLER</b>					
97-99	6	3.5L	Code "F", Main Conv.	--	2539③
<b>PLYMOUTH RELIANT</b>					
1989	4	2.2L		--	6004③
1988	4	2.2L	Auto Trans, Built After 10/12/87	4775 ☆③	6004③
87-88	4	2.2L	Manual Trans.	4775 ☆③	6004③
1986	4	2.2L	Manual Trans.	--	6004③
1986	4	2.2L	Auto Trans.	--	6004③
1985	4	2.2L	Exc. Fuel Injection	--	6004③
1985	4	2.2L	Fuel Injection	--	6004③
81-84	4	2.2L	Front, w/ Air Tube	--	6004③
81-82	4	2.2L	Rear, w/Air Tube	--	6004③
81-82	4	2.2L	Front, w/o Air Tube	--	6904③
1989	4	2.5L	Auto Trans.	4775 ☆③	6004③
87-88	4	2.5L		4775 ☆③	6004③
1986	4	2.5L		4775 ☆③	6004③
83-85	4	2.6L		--	6904③
81-82	4	2.6L		--	6904③
<b>PLYMOUTH SAPPORO</b>					
78-79	4	1.6L		--	6904③
81-83	4	2.6L		--	6906③
<b>PLYMOUTH SCAMP</b>					
1983	4	2.2L		--	6904③
<b>PLYMOUTH SUNDANCE, DUSTER</b>					
1994	4	2.2L		4051 ☆③	6004③
90-93	4	2.2L		4051 ☆③	6004③
1989	4	2.2L		4051 ☆③	6004③
87-88	4	2.2L	(Exc. Turbo)	4051 ☆③	6004③
87-88	4	2.2L	Turbo	--	6905③
1994	4	2.5L		4051 ☆③	6004③
89-93	4	2.5L	(Exc. Turbo)	4051 ☆③	6004③
89-91	4	2.5L	Turbo	--	6905③
93-94	6	3.0L		4875 ③	6905③

☆ Air Tube kit 4948 may be required for installation.

③ Federal & California Emissions. Not For Sale or Use on vehicles licensed in the state of CA & NY (NY vehicles with CA Emissions). Check with your state authority for details.

④ Federal Emissions. Not For Sale or Use on vehicles licensed in the state of CA. Check with your state authority.



YR/YRS	CYL	LITER	DESCRIPTION	DIRECT FIT	UNIVERSAL
<b>PLYMOUTH TRAILDUSTER</b>					
1980	6	3.7L	Underbody	--	2905③
78-79	6	3.7L		--	6905③
75-80	8	5.2L		--	2906③
75-80	8	5.9L		--	2906③
1976	8	6.6L		--	8006③
80-81	8	All	2WD, Rear	--	2906③
80-81	8	All	4WD, Rear	--	2906③
<b>PLYMOUTH TURISMO</b>					
83-85	4	1.6L		--	6004③
1983	4	1.6L		--	6004③
<b>PLYMOUTH VALIANT, SCAMP</b>					
75-76	6	3.7L		--	6904③
75-76	8	5.2L	2 Dr. Coupe	--	6905③
1976	8	5.9L		--	6905③
75-76	8	All	(Exc. 2 Dr. Coupe w/318 C.I.D.)	--	6905③
<b>PLYMOUTH VOLARE</b>					
1980	6	3.7L	2 Dr., Rear	--	6904③
1980	6	3.7L	2 Dr., Main & Pre-Cat	--	6004③
1980	6	3.7L	4 Dr. or Station Wgn., Rear	--	6904③
1980	6	3.7L	4 Dr. or Station Wgn., Main & Pre-Cat	--	6004③
1979	6	3.7L	2 Dr., Rear	--	6004③
1979	6	3.7L	2 Dr., Main & Pre-Cat	--	6004③
1979	6	3.7L	4 Dr. or Station Wgn., Rear	--	6904③
1979	6	3.7L	4 Dr. or Station Wgn., Main & Pre-Cat	--	6004③
1978	6	3.7L	2 Dr.	--	6905③
1978	6	3.7L	4 Dr. or Station Wgn.	--	6905③
1977	6	3.7L	2 Dr., 2-1/4" Pipe	--	6905③
1977	6	3.7L	2 Dr., 1-7/8" Pipe	--	6904③
1977	6	3.7L	4 Dr. or Station Wgn., 2-1/4" Pipe	--	6905③
1977	6	3.7L	4 Dr. or Station Wgn., 1-7/8" Pipe	--	6904③
1976	6	3.7L	2 Dr.	--	6904③
1976	6	3.7L	4 Dr. or Station Wgn.	--	6904③
79-80	8	5.2L	2 Dr., Rear	--	6905③
79-80	8	5.2L	2 Dr., Main Plus Pre-Cat	--	6005③
79-80	8	5.2L	4 Dr. or Station Wgn., Rear	--	6905③
79-80	8	5.2L	4 Dr. or Station Wgn., Main Plus Pre Cat	--	6005③
76-78	8	5.2L	2 Dr.	--	6905③
76-78	8	5.2L	4 Dr. or Station Wgn.	--	6905③
79-80	8	5.9L	Left	--	6905③
79-80	8	5.9L	Right	--	6905③
76-78	8	5.9L	2 Dr.	--	6905③
76-78	8	5.9L	4 Dr. or Station Wgn.	--	6905③
<b>PLYMOUTH VOYAGER</b>					
84-87	4	2.2L		--	6904③
96-00	4	2.4L		4967 ③	2540③
89-95	4	2.5L	(Exc. Turbo)	4953 ③	6904③
89-90	4	2.5L	Turbo	--	6905③

③ Federal & California Emissions. Not For Sale or Use on vehicles licensed in the state of CA & NY (NY vehicles with CA Emissions). Check with your state authority for details.

**APPLICATION LISTINGS  
FEDERAL CONVERTERS**



YR/YRS	CYL	LITER	DESCRIPTION	DIRECT FIT	UNIVERSAL
<b>PLYMOUTH VOYAGER (Cont.)</b>					
1988	4	2.5L		4953 ③	6904 ③
84-87	4	2.6L	w/Front Conv.	--	6904 ③
84-87	4	2.6L	w/Rear Conv.	--	6904 ③
96-00	6	3.0L		4887 ③	2540 ③
92-95	6	3.0L		4049 ③	2905 ③
89-91	6	3.0L		4765 ③	6905 ③
87-88	6	3.0L		--	6905 ③
96-00	6	3.3L	Federal Emissions	4967 ④	2540 ④
96-00	6	3.3L	California Emissions	4183 ⑤	2540 ⑤
94-95	6	3.3L	AWD	4892 ③	2906 ③
94-95	6	3.3L	(Exc. AWD or Flexible Fuel)	4049 ③	2905 ③
92-93	6	3.3L	(Exc. AWD)	4652 ③	6905 ③
91-93	6	3.3L	AWD	4892 ③	2906 ③
90-91	6	3.3L	(Exc. AWD)	4466 ③	6905 ③
96-99	6	3.8L	Federal Emissions	4967 ④	2540 ④
96-99	6	3.8L	California Emissions	4183 ⑤	2540 ⑤
94-95	6	3.8L	AWD	4892 ③	2906 ③
94-95	6	3.8L	(Exc. AWD or Flexible Fuel)	4049 ③	2905 ③
<b>PONTIAC 6000</b>					
86-91	4	2.5L	Conv. Only	4155 ☆②③	6004 ③
86-91	4	2.5L	Conv. w/Front Pipe, w/o Air Tube	4076 ③	6904 ③
82-85	4	2.5L		--	6004 ③
86-89	6	2.8L	Conv. Only	4155 ☆②③	6004 ③
86-89	6	2.8L	Conv. w/Front Pipe	--	6004 ③
82-85	6	2.8L		--	6004 ③
90-91	6	3.1L	(Exc. AWD), Converter Only	4155 ☆②③	6004 ③
1990	6	3.1L	AWD	--	6904 ③
<b>PONTIAC ACADIAN</b>					
81-87	4	1.6L		--	6004 ③
76-80	4	All		--	6905 ③
<b>PONTIAC ASTRE</b>					
76-77	4	2.3L		--	6905 ③
1975	4	2.3L	w/o Air Tube	--	6905 ③
1975	4	2.3L	w/Air Tube	--	6005 ③
1977	4	2.5L		--	6905 ③
<b>PONTIAC AZTEK</b>					
01-05	6	3.4L	AWD	4246 ③	2505R ③
01-05	6	3.4L	FWD	4760 ③	2565R ③
<b>PONTIAC BONNEVILLE</b>					
00-05	6	3.8L	(Exc. Supercharged, Use w/OE Pipe, Includes Resonator)	9035 ③	2517 ③
00-05	6	3.8L	For use with Aftermarket pipes, additional sizing, bushings, cutting may be required due to OE exhaust design.	9988 ③	2517 ③
98-99	6	3.8L	Supercharged	--	2517 ③
97-99	6	3.8L	Models w/4 Bolt Flange Inlet, front pipe & conv. separate, for use with OE intermediate pipe, additional sizing, bushings, cutting may be required due to OE exhaust design, # 3 bushing may be required.	4890 ②③	2516 ③
				--	--
				--	--
				--	--

☆ Air Tube kit 4948 may be required for installation.

② When using with aftermarket piping, direct fit converter may require INLET/OUTLET pipe resizing.

③ Federal & California Emissions. Not For Sale or Use on vehicles licensed in the state of CA & NY (NY vehicles with CA Emissions). Check with your state authority for details.

④ Federal Emissions. Not For Sale or Use on vehicles licensed in the state of CA. Check with your state authority.

⑤ California Emissions. Not For Sale or Use on vehicles licensed in the state of CA & NY. Check with your state authority.

YR/YRS	CYL	LITER	DESCRIPTION	DIRECT FIT	UNIVERSAL
<b>PONTIAC BONNEVILLE (Cont.)</b>					
97-99	6	3.8L	Models w/4 Bolt Flange Inlet, front pipe & conv. separate, for use with aftermarket intermediate pipe, additional sizing, bushings, cutting may be required due to OE exhaust design.	4890G ②③ -- --	2516③ -- --
95-96	6	3.8L	Code "K" Eng., front pipe & conv. 1 piece, additional sizing, bushings, cutting may be required due to OE exhaust design, # 3 bushing may be required.	4975 ②③ -- --	2516③ -- --
93-95	6	3.8L	Supercharged	--	2906③
92-94	6	3.8L	(Exc. Supercharged), For use with OE intermediate pipe, additional sizing, bushings, cutting may be required due to OE exhaust design, # 3 bushing may be required.	4646 ②③ -- --	6906③ -- --
92-94	6	3.8L	(Exc. Supercharged), For use with aftermarket intermediate pipe, additional sizing, bushings, cutting may be required due to OE exhaust design.	4646G ②③ -- --	6906③ -- --
92-93	6	3.8L	SSE, Additional sizing, bushings, cutting may be required due to OE exhaust design.	9036 ☆②③ --	2905③ --
88-91	6	3.8L	For use with OE intermediate pipe, # 6 bushing may be required with aftermarket pipe.	4120 ②③ --	6905③ --
88-91	6	3.8L	For use w/2-3/8" I.D. aftermarket intermediate piping.	4120G ③	6905③
1987	6	3.8L	For use with OE intermediate pipe.	4501 ②③	6905③
1987	6	3.8L	For use w/2-3/8" I.D. intermediate piping.	--	6905③
84-86	6	3.8L		4112 ☆③	6005③
1983	6	3.8L	California Emissions	4111 ☆⑤	6005⑤
1983	6	3.8L	Federal Emissions	4112 ☆④	6005④
1980	6	3.8L		--	6906③
1986	6	4.3L		4303 ☆③	6005③
81-82	6	All		--	6005③
04-05	8	4.6L	Use w/OE Pipe, Includes Resonator	9035 ③	2517③
1980	8	4.9L		--	6006③
84-86	8	5.0L		4115 ☆③	6005③
1980	8	5.7L	Code "X"	--	6006③
1980	8	5.7L	Code "R"	--	6005③
77-78	8	6.6L	400 C.I.D.	--	8006③
75-76	8	6.6L		--	8006③
75-76	8	7.5L		--	8006③
81-83	8	All		4111 ☆③	6005③
77-79	8	All	(Exc. 400 C.I.D.)	--	6906③
<b>PONTIAC CATALINA</b>					
1980	6	3.8L		--	6906③
77-79	6	3.8L		--	6906③
1981	6	All		4111 ☆③	6005③
1980	8	4.9L		--	6006③
1980	8	5.7L	Code "X"	--	6006③
1980	8	5.7L	Code "R"	--	6005③
1976	8	5.7L		--	6906③
77-78	8	6.6L	400 C.I.D.	--	8006③
75-76	8	6.6L		--	8006③
75-76	8	7.5L		--	8006③

☆ Air Tube kit 4948 may be required for installation.

② When using with aftermarket piping, direct fit converter may require INLET/OUTLET pipe resizing.

③ Federal & California Emissions. Not For Sale or Use on vehicles licensed in the state of CA & NY (NY vehicles with CA Emissions). Check with your state authority for details.

④ Federal Emissions. Not For Sale or Use on vehicles licensed in the state of CA. Check with your state authority.

204 ⑤ California Emissions. Not For Sale or Use on vehicles licensed in the state of CA & NY. Check with your state authority.

# APPLICATION LISTINGS

## FEDERAL CONVERTERS



YR/YRS	CYL	LITER	DESCRIPTION	DIRECT FIT	UNIVERSAL
<b>PONTIAC CATALINA (Cont.)</b>					
1981	8	All		4111 ☆③	6005③
77-79	8	All	(Exc. 400 C.I.D.)	--	6906③
<b>PONTIAC FIERO</b>					
87-88	4	2.5L		--	6004③
84-86	4	2.5L		--	6003③
87-88	6	2.8L		--	6004③
85-86	6	2.8L		--	6003③
<b>PONTIAC FIREBIRD, TRANS AM, FORMULA</b>					
82-85	4	2.5L		--	6004③
1982	6	2.8L		--	6005③
93-95	6	3.4L		4517 ③	6905③
00-01	6	3.8L		4278 ③	2516③
2000	6	3.8L	Federal Emissions	4278 ③	2516③
95-99	6	3.8L		4884 ③	2540③
1981	6	3.8L	231 C.I.D.	4111 ☆③	6005③
1980	6	3.8L	231 C.I.D.	--	6005③
77-79	6	3.8L		--	6905③
75-76	6	4.1L		--	6905③
83-92	6	All		4115 ☆③	6005③
1981	8	4.3L		4111 ☆③	6005③
1981	8	4.9L	Includes Turbo	4111 ☆③	6005③
1980	8	4.9L	(Exc. High Performance)	--	6906③
1980	8	4.9L	High Performance	--	8006③
1979	8	4.9L		--	8005③
1977	8	4.9L		--	8005③
90-92	8	5.0L	Code "E" & "F", (Exc. Dual Conv. System & 2 3/4" Ext. Pipe)	4115 ☆③	6005③
89-92	8	5.0L	Code "F", Dual Conv. System, Left, Additional sizing, bushings, cutting may be required due to OE exhaust design.	--	2905③
89-92	8	5.0L	Code "F", Dual Conv. System, Right, Additional sizing, bushings, cutting may be required due to OE exhaust design.	--	2905③
89-92	8	5.0L	Code "F", Dual Conv. System, Complete	--	2905③
86-89	8	5.0L	Code "F" & "G", (Exc. Dual Conv. System)	9118 ☆③	2907③
83-89	8	5.0L	Code "E" & "H", (83-87 Code H) & (88-89 Code E)	4115 ☆③	6005③
84-85	8	5.0L	Code "F" & "G"	4116 ☆③	6006③
1983	8	5.0L	Code "7"	4116 ☆③	6006③
1983	8	5.0L	Code "S"	4115 ☆③	6005③
1982	8	5.0L	Code "7"	4115 ☆③	6005③
1982	8	5.0L	Code "H", Angled Conv.	--	2905③
1982	8	5.0L	Code "H", Straight Conv.	--	2905③
1981	8	5.0L	(Exc. Trans Am)	4111 ☆③	6005③
1981	8	5.0L	Code "H", Trans Am	--	6905③
1980	8	5.0L		--	6906③
77-79	8	5.0L		--	6905③
00-02	8	5.7L	Left	9107 ③	--
00-02	8	5.7L	Right	9106 ③	--
98-99	8	5.7L	Left	9034 ③	--
98-99	8	5.7L	Right	9033 ③	--

☆ Air Tube kit 4948 may be required for installation.

③ Federal & California Emissions. Not For Sale or Use on vehicles licensed in the state of CA & NY (NY vehicles with CA Emissions). Check with your state authority for details.

YR/YRS	CYL	LITER	DESCRIPTION	DIRECT FIT	UNIVERSAL
<b>PONTIAC FIREBIRD, TRANS AM, FORMULA (Cont.)</b>					
96-97	8	5.7L		9062 ③	2516③
96-97	8	5.7L	Front	9162 ③	--
1995	8	5.7L	Federal Emissions	9069 ④	9007④
1995	8	5.7L	Rear, California Emissions	9062 ⑤	8006⑤
1995	8	5.7L	Front, California Emissions	9162 ⑤	--
93-94	8	5.7L		9069 ③	9007③
89-92	8	5.7L	Code "8", Dual Conv. System, Left, Additional sizing, bushings, cutting may be required due to OE exhaust design.	--	2905③
89-92	8	5.7L	Code "8", Dual Conv. System, Right, Additional sizing, bushings, cutting may be required due to OE exhaust design.	--	2905③
89-92	8	5.7L	Code "8", Dual Conv. System, Complete	--	2905③
87-89	8	5.7L	(Exc. Dual Conv. System)	9118 ☆③	2907③
75-79	8	5.7L		--	8005③
78-79	8	6.6L	403 C.I.D., Single Exhaust	--	8005③
78-79	8	6.6L	403 C.I.D., Dual Exhaust	--	8005③
77-79	8	6.6L	400 C.I.D., Single Exhaust	--	8005③
77-79	8	6.6L	400 C.I.D., Dual Exhaust	--	8005③
75-77	8	6.6L	400 C.I.D.	--	8005③
<b>PONTIAC FIREFLY</b>					
1995	3	1.0L	Rear, (Canada Model)	4669 ③	6904③
1991	3	1.0L	(Exc. Turbo) (Canada Model)	4170 ③	6904③
89-91	3	1.0L	Turbo (Canada Model)	--	6904③
87-88	3	1.0L	Turbo (Canada Model)	--	6904③
85-88	3	1.0L	(Exc. Turbo) (Canada Model)	4170 ③	6904③
96-97	4	1.3L	(Canada Model)	4886 ③	6904③
93-95	4	1.3L	Rear, (Canada Model)	--	6904③
<b>PONTIAC G3</b>					
09-10	4	1.6L	Rear	4404 ③	--
<b>PONTIAC G5</b>					
08-09	4	2.2L	Manual Trans.	--	2565R③○
08-09	4	2.2L	Auto Trans.	4284 ③	2565R③
2007	4	2.2L	Auto Trans.	4015 ③	2564R③○
2007	4	2.2L	Manual Trans.	--	2565R③○
2008	4	2.4L	Auto Trans.	4284 ③	2565R③○
2008	4	2.4L	Manual Trans.	--	2565R③
2007	4	2.4L	Auto Trans.	4015 ③	2564R③○
2007	4	2.4L	Manual Trans.	--	2565R③○
<b>PONTIAC G6</b>					
09-10	4	2.4L	6 Speeds, Front	5219 ③	--
08-10	4	2.4L	Rear, OE exhaust system is completely welded, additional adapters or sizing of the OE pipe may be required to complete installation.	4714 ③	--
06-10	4	2.4L	Manifold Unit, Front	4539 ③○	--
			Manifold Unit, Front	1231 ③	--
08-10	6	3.5L	Front Manifold Conv., Exc. GT Convertible Models	1238 ③	--
08-10	6	3.5L	Rear Manifold Conv., Exc. GT Convertible Models	1239 ③	--
08-10	6	3.5L	Rear, OE exhaust system is completely welded, additional adapters or sizing of the OE pipe may be required to complete installation.	4746 ③	--

③ Discontinued, use until inventory is depleted.

☆ Air Tube kit 4948 may be required for installation.

③ Federal & California Emissions. Not For Sale or Use on vehicles licensed in the state of CA & NY (NY vehicles with CA Emissions). Check with your state authority for details.

④ Federal Emissions. Not For Sale or Use on vehicles licensed in the state of CA. Check with your state authority.

⑤ California Emissions. Not For Sale or Use on vehicles licensed in the state of CA & NY. Check with your state authority.

○ EPA Enhanced OBDII By Design Unit

**APPLICATION LISTINGS**  
**FEDERAL CONVERTERS**



YR/YRS	CYL	LITER	DESCRIPTION	DIRECT FIT	UNIVERSAL
<b>PONTIAC G6 (Cont.)</b>					
2007	6	3.5L	Front Right	5218 ③	--
05-06	6	3.5L	Front	4424 ③	2554③
05-06	6	3.5L	Rear Conv.	4728 ③	--
07-08	6	3.6L	Front Conv.	4542 ③	--
07-08	6	3.6L	Rear Conv.	4543 ③	--
06-07	6	3.9L	Front Right	5218 ③	--
<b>PONTIAC G8</b>					
08-09	8	6.0L	Left	--	2572R③
08-09	8	6.0L	Right	--	2572R③
08-09	8	6.0L	Left	9547 ③	--
08-09	8	6.0L	Right	9548 ③	--
2009	8	6.2L	Left	--	2572R③
2009	8	6.2L	Right	--	2572R③
<b>PONTIAC GRAND AM</b>					
87-89	4	2.0L	Turbo	--	6005③
02-05	4	2.2L		4205 ③	2505R③
93-95	4	2.3L	Quad 4, Code "D" Eng.	4719 ③	6904R③
1992	4	2.3L	Code "3" Eng.	--	6903③
90-92	4	2.3L	Quad 4, Code "D" Eng.	--	6905③
1989	4	2.3L	Quad 4, Code "D" Eng., additional sizing, bushings, cutting may be required due to OE exhaust design, # 6 bushing may be required.	--	6905③
1988	4	2.3L	Quad 4, Code "D" Eng., additional sizing, bushings, cutting may be required due to OE exhaust design.	--	6905③
99-01	4	2.4L	SE Models, 2nd Design Built After 1/99 (inlet flange 3 bolt)	4877 ③	2505R③
1999	4	2.4L	1st Design built up to 1/99 (Inlet flange 4 bolt)	4107 ③	2504R③
96-98	4	2.4L	Auto Trans.	4823 ③	2504R③
96-98	4	2.4L	Manual Trans.	4220 ③	2505R③
90-91	4	2.5L		4595 ③	6904③
90-91	4	2.5L	Optional Direct Fit Converter	--	6904③
85-89	4	2.5L	Additional sizing, bushings, cutting may be required due to OE exhaust design, two # 8 bushings may be required.	4117 ②③	6904③
85-87	6	3.0L	Additional sizing, bushings, cutting may be required due to OE exhaust design, two # 8 bushings may be required.	4117 ②③	6904③
97-98	6	3.1L		4849 ③	2504R③
1996	6	3.1L		4862 ③	2504R③
94-95	6	3.1L		4793 ③	6904R③
92-93	6	3.3L		4589 ③	6905③
2005	6	3.4L	GT	4863 ③	2504R③
99-04	6	3.4L		4863 ③	2504R③
78-79	8	4.9L		--	6905③
1979	8	5.0L	4 bbl. Carb.	--	6906③
1978	8	5.0L	2 bbl. Carb.	4111 ☆③	6905③
1980	8	All		--	6006③
1975	8	All		--	8006③

☆ Air Tube kit 4948 may be required for installation.

② When using with aftermarket piping, direct fit converter may require INLET/OUTLET pipe resizing.

③ Federal & California Emissions. Not For Sale or Use on vehicles licensed in the state of CA & NY (NY vehicles with CA Emissions). Check with your state authority for details.

YR/YRS	CYL	LITER	DESCRIPTION	DIRECT FIT	UNIVERSAL
<b>PONTIAC GRAND PRIX</b>					
90-91	4	2.3L	For use with OE intermediate pipe, additional sizing, bushings, cutting may be required due to OE exhaust design, # 6 bushing may be required at inlet & # 8 bushing may be required at outlet for use w/aftermarket pipe.	4137 ②③ -- -- --	6905③ -- -- --
90-91	4	2.3L	For use w/2-1/8" I.D. intermediate piping, additional sizing, bushings, cutting may be required due to OE exhaust design.	4137G ②③ --	6905③ --
88-89	6	2.8L	For use with OE intermediate pipe, additional sizing, bushings, cutting may be required due to OE exhaust design, # 6 bushing may be required at inlet & # 8 bushing may be required at outlet for use w/aftermarket pipe.	4137 ②③ -- -- --	6905③ -- -- --
88-89	6	2.8L	For use w/2-1/8" I.D. intermediate piping, additional sizing, bushings, cutting may be required due to OE exhaust design.	4137G ②③ --	6905③ --
97-03	6	3.1L		4850 ③	2505R③
95-96	6	3.1L	Models w/Post Conv. O2 Sensor	4838 ③	2505R③
94-95	6	3.1L	(Exc. Models w/Post Conv. O2 Sensor)	4629 ③	6904R③
1993	6	3.1L	California Emissions w/Dual Exhaust	--	6905⑤
90-93	6	3.1L	Dual Exhaust, 1990 2nd Design	4141 ③	2904③
89-93	6	3.1L	(Exc. Dual Exhaust), For use with OE intermediate pipe, additional sizing, bushings, cutting may be required due to OE exhaust design, # 6 bushing may be required at inlet & # 8 bushing may be required at outlet for use w/aftermarket pipe.	4137 ②③ -- -- --	6905③ -- -- --
89-93	6	3.1L	(Exc. Dual Exhaust), For use w/2-1/8" I.D. aftermarket intermediate piping, additional sizing, bushings, cutting may be required due to OE exhaust design.	4137G ②③ -- --	6905③ -- --
89-90	6	3.1L	Dual Exhaust, 1990 1st Design, For use with OE intermediate pipe, Additional sizing, bushings, cutting may be required due to OE exhaust design, # 6 bushing may be required at inlet & # 8 bushing may be required at outlet for use w/aftermarket pipe.	4137 ②③ -- -- --	6905③ -- -- --
89-90	6	3.1L	Dual Exhaust, 1990 1st Design, For use w/2-1/8" I.D. intermediate piping, Additional sizing, bushings, cutting may be required due to OE exhaust design.	4137G ②③ -- --	6905③ -- --
1996	6	3.4L		4898 ③	2506R③
94-95	6	3.4L		4779 ③	6906③
91-93	6	3.4L		4779 ③	6906③
04-08	6	3.8L		4341 ③ --	2575③○ 2538③□
97-03	6	3.8L		4876 ③ --	2576R③○ 2506R③□
84-87	6	3.8L		4112 ☆③	6005③
1983	6	3.8L	Federal Emissions	4112 ☆④	6005④
1983	6	3.8L	California Emissions	4111 ☆⑤	6905⑤
1981	6	3.8L		4111 ☆③	6905③
1980	6	3.8L		--	6906③
1979	6	3.8L		--	6905③
86-87	6	4.3L		4303 ☆③	6005③
1982	6	All		4111 ☆③	6905③
78-79	8	4.9L		4111 ☆③	6905③

☆ Air Tube kit 4948 may be required for installation.

② When using with aftermarket piping, direct fit converter may require INLET/OUTLET pipe resizing.

③ Federal & California Emissions. Not For Sale or Use on vehicles licensed in the state of CA & NY (NY vehicles with CA Emissions). Check with your state authority for details.

④ Federal Emissions. Not For Sale or Use on vehicles licensed in the state of CA. Check with your state authority.

208 ⑤ California Emissions. Not For Sale or Use on vehicles licensed in the state of CA & NY. Check with your state authority.

□ EPA OBDII By Design Unit

○ EPA Enhanced OBDII By Design Unit

**APPLICATION LISTINGS**  
**FEDERAL CONVERTERS**



YR/YRS	CYL	LITER	DESCRIPTION	DIRECT FIT	UNIVERSAL
<b>PONTIAC GRAND PRIX (Cont.)</b>					
84-87	8	5.0L	Code 'H' Eng.	4115 ☆③	6005③
1979	8	5.0L		--	6906③
1978	8	5.0L		--	6905③
05-08	8	5.3L	GXP Model	4531 ③	--
81-83	8	All		4111 ☆③	6905③
1980	8	All		--	6906③
76-77	8	All	(Exc. 400, 403, & 455 C.I.D.)	--	6906③
75-77	8	All	400, 403, & 455 C.I.D.	--	8006③
<b>PONTIAC GRANDVILLE</b>					
1975	8	6.6L		--	8006③
<b>PONTIAC GTO</b>					
2004	8	5.7L	Left	--	2565R③○
2004	8	5.7L	Right	--	2565R③○
05-06	8	6.0L	Right Side with Extension Pipe	4744 ③	--
05-06	8	6.0L	Left Side	4745 ③	--
<b>PONTIAC J2000</b>					
1984	4	1.8L	Turbo	--	6004③
82-84	4	1.8L	(Exc. Turbo)	--	6003③
<b>PONTIAC LE MANS</b>					
90-93	4	1.6L		--	6906③
88-89	4	1.6L	Auto Trans.	--	6004③
88-89	4	1.6L	Manual Trans.	--	6004③
1989	4	2.0L	Manual Trans.	--	6004③
1989	4	2.0L	Auto Trans.	--	6904③
1981	6	3.8L	(Exc. Canada)	4111 ☆③	6005③
1980	6	3.8L	231 C.I.D., (Exc. Canada)	--	6006③
1980	6	3.8L	229 C.I.D., (Exc. Canada)	--	6005③
78-79	6	3.8L	(Exc. Canada)	--	6905③
78-83	6	All	(Canada Model)	--	6005③
75-77	6	All	(Exc. Canada)	--	6906③
1981	8	4.3L	(Exc. Canada)	4111 ☆③	6005③
1976	8	4.3L	(Exc. Canada)	--	6906③
1979	8	4.9L	(Exc. Canada)	--	6005③
1977	8	4.9L	(Exc. Canada)	--	6906③
1979	8	5.0L	4 bbl. Carb. (Exc. Canada)	--	6906③
1978	8	5.0L	2 bbl. Carb. (Exc. Canada)	4111 ☆③	6005③
78-79	8	5.7L	(Exc. Canada)	--	6906③
75-77	8	5.7L	(Exc. Canada)	--	6906③
1977	8	6.6L	403 C.I.D., (Exc. Canada)	--	8006③
75-77	8	6.6L	400 C.I.D., (Exc. Canada)	--	8006③
75-76	8	7.5L	(Exc. Canada)	--	8006③
1980	8	All	(Exc. Canada)	--	6906③
<b>PONTIAC MONTANA</b>					
02-05	6	3.4L	FWD	4307 ③	2516③
2001	6	3.4L		4327 ③	2516③
99-00	6	3.4L		4133 ③	2505R③
05-06	6	3.5L	FWD	4429 ③	2566③

☆ Air Tube kit 4948 may be required for installation.

③ Federal & California Emissions. Not For Sale or Use on vehicles licensed in the state of CA & NY (NY vehicles with CA Emissions). Check with your state authority for details.

○ EPA Enhanced OBDII By Design Unit



YR/YRS	CYL	LITER	DESCRIPTION	DIRECT FIT	UNIVERSAL
<b>PONTIAC MONTANA (Cont.)</b>					
07-08	6	3.9L		4464 ③	2565③○
<b>PONTIAC OPTIMA</b>					
88-91	4	1.6L	(Canada Model)	--	6904③
88-90	4	2.0L	(Canada Model)	--	6905③
<b>PONTIAC PARIISIENNE</b>					
84-85	6	3.8L	(Exc. Canada)	4112 ☆③	6005③
1986	6	4.3L	(Exc. Canada)	4303 ☆③	6005③
77-82	6	All	(Canada Model)	--	6005③
1986	8	5.0L	Code "Y", (Exc. Station Wgn.), Recommended For Sound Control (Exc. Canada)	--	2905③
1986	8	5.0L	Code "Y", (Exc. Station Wgn.), Optional Direct Fit Converter (Exc. Canada)	4119 ③	6005③
85-86	8	5.0L	Code "H", Recommended For Sound Control (Exc. Canada)	9133 ③	2905③
85-86	8	5.0L	Code "H", Optional Direct Fit Converter (Exc. Canada)	4115 ③	6005③
76-80	8	All	(Canada Model)	--	6905③
<b>PONTIAC PHOENIX</b>					
82-84	4	2.5L		--	6004③
1981	4	2.5L		--	6003③
1980	4	2.5L		--	6904③
83-84	6	2.8L	Code "W", "X" & "Z" Eng.	--	6004③
1982	6	2.8L	(Exc. Code "Z" Eng.)	--	6004③
1982	6	2.8L	Code "Z" Eng.	4303 ☆③	6005③
1981	6	2.8L		--	6003③
1980	6	2.8L		--	6904③
77-79	6,8	All		--	6905③
<b>PONTIAC SAFARI STATION WAGON</b>					
87-89	8	5.0L		--	2905③
87-89	8	5.0L	Optional Direct Fit Converter	4119 ☆③	6005③
<b>PONTIAC SUNBIRD</b>					
85-86	4	1.8L	Turbo	--	6005③
85-86	4	1.8L	(Exc. Turbo)	--	6003③
90-94	4	2.0L	(Exc. 1990 Turbo)	4414 ③	6904③
90-94	4	2.0L	(Exc. 1990 Turbo), Optional Direct Fit Converter	--	6904③
1990	4	2.0L	Turbo	--	6004③
1989	4	2.0L	(Exc. Turbo), Additional sizing, bushings, cutting may be required due to OE exhaust design.	4117 ②③	6904③
87-89	4	2.0L	Turbo	--	6005③
87-88	4	2.0L	(Exc. Turbo)	--	6004③
78-80	4	2.5L		--	6905③
1977	4	2.5L		--	6905③
91-94	6	3.1L	Additional sizing, bushings, cutting may be required due to OE exhaust design.	4117 ②③	6904③
76-80	6	All		--	6905③
<b>PONTIAC SUNBURST</b>					
87-89	4	1.5L	Rear, (Exc. Turbo) (Canada Model)	--	6906③
85-86	4	1.5L	(Exc. Turbo) (Canada Model)	--	6906③

☆ Air Tube kit 4948 may be required for installation.

② When using with aftermarket piping, direct fit converter may require INLET/OUTLET pipe resizing.

③ Federal & California Emissions. Not For Sale or Use on vehicles licensed in the state of CA & NY (NY vehicles with CA Emissions). Check with your state authority for details.

○ EPA Enhanced OBDII By Design Unit

**APPLICATION LISTINGS  
FEDERAL CONVERTERS**



YR/YRS	CYL	LITER	DESCRIPTION	DIRECT FIT	UNIVERSAL
<b>PONTIAC SUNFIRE</b>					
03-05	4	2.2L		4205 ③	2504R③
2002	4	2.2L	Code F Eng.	4205 ③	2504R③
2002	4	2.2L	Code 4 Eng.	4864 ③	2504R③
99-01	4	2.2L		4864 ③	2504R③
96-98	4	2.2L		4648 ③	2504③
99-02	4	2.4L		4877 ③	2504R③
96-98	4	2.4L		4107 ③	2504R③
<b>PONTIAC T1000</b>					
81-87	4	1.6L		--	6004③
<b>PONTIAC TEMPEST</b>					
87-91	4	All	Manual Trans. (Canada Model)	--	6904③
87-91	4	All	Auto Trans. (Canada Model)	--	6904③
87-91	6	All	(Canada Model)	--	6004③
<b>PONTIAC TORRENT</b>					
06-09	6	3.4L		4357 ③	2516③
08-09	6	3.6L	Front Conv.	4444 ③	2575③○
08-09	6	3.6L	Rear Conv.	4445 ③	2575③○
<b>PONTIAC TRANS SPORT</b>					
93-95	6	3.1L		4242 ③	2905③
90-92	6	3.1L	Conv., w/Front Pipe	--	2905③
90-92	6	3.1L	Conv. Only	--	2905③
97-98	6	3.4L		4133 ③	2504R③
1996	6	3.4L		4781 ③	2516③
93-95	6	3.8L		4873 ③	2905③
<b>PONTIAC VENTURA</b>					
1977	4	2.5L		--	6905③
75-77	6,8	All		--	6905③
<b>PONTIAC VIBE</b>					
05-08	4	1.8L	FWD, (Exc. GT), Requires Resonator Pipe #58494 to Complete Installation	4805 ③	--
05-08	4	1.8L	FWD, (Exc. GT), Front	--	2565R③
05-08	4	1.8L	FWD, (Exc. GT), Rear	--	2565R③
03-06	4	1.8L	AWD, Complete Assembly Including Resonator Pipe	5049 ③	--
03-04	4	1.8L	FWD, (Exc. GT), Complete Assembly Including Resonator Pipe	4274 ③	--
03-04	4	1.8L	FWD, (Exc. GT), Requires Resonator Pipe #68432 to Complete Installation	4805 ③	--
03-04	4	1.8L	FWD, (Exc. GT), Rear	--	2565R③
03-04	4	1.8L	FWD, (Exc. GT), Front	--	2565R③
2003	4	1.8L	GT, Complete Assembly Including Resonator Pipe	5055 ③	--
09-10	4	2.4L	Manifold Unit, Front	1297 ③	--
09-10	4	2.4L	Base, Rear, OE is a Welded Assembly, 68542 Pipe Required to Complete Installation	5124 ③	--
2009	4	2.4L		--	2565R③○
<b>PORSCHE 911</b>					
78-83	6	3.0L		--	6905③
84-89	6	3.2L		--	6905③
86-89	6	3.3L	Turbo	--	6905③

③ Federal & California Emissions. Not For Sale or Use on vehicles licensed in the state of CA & NY (NY vehicles with CA Emissions). Check with your state authority for details.  
○ EPA Enhanced OBDII By Design Unit

YR/YRS	CYL	LITER	DESCRIPTION	DIRECT FIT	UNIVERSAL
<b>PORSCHE 911 (Cont.)</b>					
1995	6	3.6L	Left	--	2504R <sup>③</sup>
1995	6	3.6L	Right	--	2504R <sup>③</sup>
90-94	6	3.6L		--	6904R <sup>③</sup>
<b>PORSCHE 914</b>					
1975	4	1.8L		--	6904 <sup>③</sup>
<b>PORSCHE 924</b>					
80-82	4	2.0L	Turbo	--	6904R <sup>③</sup>
80-82	4	2.0L	(Exc. Turbo)	--	6904R <sup>③</sup>
77-79	4	2.0L		--	6904R <sup>③</sup>
87-88	4	2.5L	"S" Models	--	6904 <sup>③</sup>
<b>PORSCHE 928</b>					
78-82	8	4.5L		--	2905 <sup>③</sup>
83-84	8	4.7L		--	2905 <sup>③</sup>
90-91	8	5.0L	Left	--	6904R <sup>③</sup>
90-91	8	5.0L	Right	--	6904R <sup>③</sup>
87-89	8	5.0L		--	6005 <sup>③</sup>
85-86	8	5.0L		--	6005 <sup>③</sup>
93-95	8	5.4L	Left	--	6904R <sup>③</sup>
93-95	8	5.4L	Right	--	6904R <sup>③</sup>
<b>PORSCHE 944</b>					
86-88	4	2.5L	(Exc. Turbo)	--	6904 <sup>③</sup>
1989	4	2.7L	(Exc. Turbo)	--	6904 <sup>③</sup>
90-91	4	3.0L		--	2905 <sup>③</sup>
<b>PORSCHE 968</b>					
92-94	4	3.0L		--	6905 <sup>③</sup>
<b>RAM 1500</b>					
11-12	8	5.7L		9462 <sup>③</sup>	--
<b>RENAULT ALLIANCE</b>					
83-87	4	1.4L		--	6904 <sup>③</sup>
85-87	4	1.7L		--	6904 <sup>③</sup>
1987	4	All	GTA	--	6904 <sup>③</sup>
<b>RENAULT ENCORE</b>					
84-86	4	1.4L		--	6904 <sup>③</sup>
85-86	4	1.7L		--	6904 <sup>③</sup>
<b>RENAULT FUEGO</b>					
82-83	4	1.6L	(Exc. Turbo)	--	6904 <sup>③</sup>
84-85	4	2.2L	(Exc. Turbo)	--	6904 <sup>③</sup>
83-84	4	All	Turbo	--	6804 <sup>③</sup>
<b>RENAULT LECAR</b>					
78-79	4	1.3L		--	6903 <sup>③</sup>
80-84	4	1.4L		--	6903 <sup>③</sup>
<b>RENAULT R12, R15</b>					
75-77	4	1.6L		--	6904 <sup>③</sup>
<b>RENAULT R17, GORDINI</b>					
75-79	4	1.6L		--	6903 <sup>③</sup>
<b>RENAULT R18I</b>					
81-83	4	1.6L		--	6904 <sup>③</sup>
84-86	4	2.2L	Sportwagon	--	6904 <sup>③</sup>

③ Federal & California Emissions. Not For Sale or Use on vehicles licensed in the state of CA & NY (NY vehicles with CA Emissions). Check with your state authority for details.

**APPLICATION LISTINGS**  
**FEDERAL CONVERTERS**



YR/YRS	CYL	LITER	DESCRIPTION	DIRECT FIT	UNIVERSAL
<b>SAAB 9-2X</b>					
2005	4	2.5L		4181 ③	--
<b>SAAB 9-3</b>					
10-11	4	2.0L	FWD, 4Dr., w/o Chrome Tailpipe, Rear	5178 ③	--
09-11	4	2.0L	FWD, Exc. 14mm Air Tube, Front	1298 ③	--
04-09	4	2.0L	Rear	5178 ③	--
05-08	4	2.0L	Chassis/VIN 51013750, Exc.14mm Air Tube, Front	1298 ③	--
03-05	4	2.0L	Turbo	--	2565R③○
2003	4	2.0L	Arc, Linear & Vector, Rear	5178 ③	--
00-02	4	2.0L	From Chassis/VIN 17008105, California Emissions	5161 ⑤	--
00-02	4	2.3L		5161 ③	--
99-02	4	All	Turbo	9047 ③	--
2009	6	2.8L	FWD, Rear	5201 ③	--
06-08	6	2.8L	Rear	5201 ③	--
<b>SAAB 9-5</b>					
04-09	4	2.3L		--	2565R③○
00-03	4	2.3L		4168 ③	--
1999	4	2.3L	Turbo	9041 ③	2539③
99-03	6	3.0L		4167 ③	--
<b>SAAB 9-7X</b>					
08-09	6	4.2L		9546 ③	--
06-07	6	4.2L		9171 ③	2506③
06-09	8	5.3L		9544 ③	--
2005	8	5.3L		9412 ③	2566③
08-09	8	6.0L		9544 ③	--
<b>SAAB 900</b>					
96-98	4	2.0L	Turbo	9047 ③	2540③
94-95	4	2.0L	Turbo	--	2904③
91-93	4	2.0L		4777 ③	6906R③
88-90	4	2.0L	Turbo	--	6905R③
88-90	4	2.0L	Turbo, Optional Direct Fit Converter	4777 ③	--
88-89	4	2.0L	DOHC 16 valve, (Exc. Turbo)	--	6903R③
1988	4	2.0L	SOHC, (Exc. Turbo)	--	6904R③
86-87	4	2.0L	DOHC, (Exc. Turbo)	--	6903R③
85-87	4	2.0L	DOHC, Turbo	--	6905R③
85-87	4	2.0L	DOHC, Turbo, Optional Direct Fit Converter	4777 ③	--
81-87	4	2.0L	SOHC	--	6904R③
1994	4	2.1L	(Exc. Turbo)	--	2904③
91-93	4	2.1L		4777 ③	6906R③
96-98	4	2.3L		--	2506③
94-95	4	2.3L	Auto Trans.	--	2904③
94-95	4	2.3L	Manual Trans.	--	2904③
79-80	4	All		--	6904R③
1996	6	2.5L	24 valve	--	2540③
94-95	6	2.5L	24 valve	--	2905③
<b>SAAB 9000</b>					
86-90	4	2.0L		--	6904③
96-98	4	2.3L	Turbo w/DOHC, Eng. Codes "R" or "M"	4089 ③	2506③

③ Federal & California Emissions. Not For Sale or Use on vehicles licensed in the state of CA & NY (NY vehicles with CA Emissions). Check with your state authority for details.

⑤ California Emissions. Not For Sale or Use on vehicles licensed in the state of CA & NY. Check with your state authority.

○ EPA Enhanced OBDII By Design Unit

YR/YRS	CYL	LITER	DESCRIPTION	DIRECT FIT	UNIVERSAL
<b>SAAB 9000 (Cont.)</b>					
93-95	4	2.3L	Turbo, DOHC	--	2905③
90-92	4	2.3L		--	6904③
96-97	6	3.0L		--	2539③
1995	6	3.0L		--	2539③
<b>SAAB 99</b>					
77-80	4	2.0L	(Exc. Turbo)	--	6904③
1978	4	2.0L	Turbo	--	6904R③
75-76	4	2.0L		--	6904③
<b>SATURN AURA</b>					
08-09	4	2.4L	Rear, OE exhaust system is completely welded, additional adapters or sizing of the OE pipe may be required to complete installation.	4714 ③	--
07-09	4	2.4L	Manifold Unit, Front	4539 ③⑩	--
			Manifold Unit, Front	1231 ③	--
2007	6	3.5L	Front Left	4424 ③	2554③
2007	6	3.5L	Front Right	5218 ③	--
07-08	6	3.6L	Front Conv.	4542 ③	--
07-08	6	3.6L	Rear Conv.	4543 ③	--
<b>SATURN ION</b>					
05-07	4	2.0L		4705 ③	--
05-07	4	2.2L	Auto Trans.	4015 ③	2564R③○
			Auto Trans.	--	2505R③□
03-04	4	2.2L		4483 ③	2574R③○
06-07	4	2.4L	Auto Trans.	4015 ③	2564R③○
			Auto Trans.	--	2505R③□
<b>SATURN L100</b>					
01-04	4	2.2L	Complete, Auto Trans.	4255 ③	2504R③
01-02	4	2.2L	Standard Trans.	5216 ③	--
<b>SATURN L200</b>					
01-04	4	2.2L	Complete, Auto Trans.	4255 ③	2504R③
01-03	4	2.2L	Standard Trans.	5216 ③	--
<b>SATURN L300</b>					
00-05	6	3.0L	Front	1069 ③	--
00-05	6	3.0L	Rear	4299 ③	--
<b>SATURN LW200</b>					
01-04	4	2.2L	Complete, Auto Trans.	4255 ③	2504R③
01-03	4	2.2L	Standard Trans.	5216 ③	--
<b>SATURN LW300</b>					
00-05	6	3.0L	Front	1069 ③	--
00-05	6	3.0L	Rear	4299 ③	--
<b>SATURN OUTLOOK</b>					
09-10	6	3.6L	Rear Main Conv.	4695 ③	--
07-10	6	3.6L	Front Conv.	4572 ③	--
07-10	6	3.6L	Rear Conv.	4573 ③	--
<b>SATURN RELAY</b>					
05-06	6	3.5L	FWD	4429 ③	2566③○
2007	6	3.9L		4464 ③	2565③○
2006	6	3.9L	FWD	4429 ③	2566③○

⑩ Discontinued, use until inventory is depleted.

③ Federal & California Emissions. Not For Sale or Use on vehicles licensed in the state of CA & NY (NY vehicles with CA Emissions). Check with your state authority for details.

□ EPA OBDII By Design Unit

○ EPA Enhanced OBDII By Design Unit

# APPLICATION LISTINGS

## FEDERAL CONVERTERS



YR/YRS	CYL	LITER	DESCRIPTION	DIRECT FIT	UNIVERSAL
<b>SATURN SC</b>					
91-92	4	1.9L	For use with OE intermediate pipe, additional sizing, bushings, cutting may be required due to OE exhaust design.	--	6905 <sup>③</sup>
91-92	4	1.9L		--	--
91-92	4	1.9L		--	6905 <sup>③</sup>
<b>SATURN SC1</b>					
01-02	4	1.9L	Semi Direct Fit Conv., SOHC, Must Reuse Front Pipe, additional sizing, bushings, cutting may be required due to OE exhaust design.	4282 <sup>③</sup>	2539 <sup>③</sup>
01-02	4	1.9L	Front, SOHC	1139 <sup>③</sup>	--
01-02	4	1.9L	Rear, SOHC, Includes Front Pipe	4339 <sup>③</sup>	2505 <sup>③</sup>
2000	4	1.9L	Semi Direct Fit Conv., SOHC, Must Reuse Front Pipe, additional sizing, bushings, cutting may be required due to OE exhaust design.	4282 <sup>③</sup>	2539 <sup>③</sup>
1999	4	1.9L	Semi Direct Fit Conv., Federal Emissions, SOHC, Use Aftermarket Front Pipe 38857 or Must Reuse Front Pipe, additional sizing, bushings, cutting may be required due to OE exhaust design.	4282 <sup>③</sup> ↗	2539 <sup>③</sup>
98-99	4	1.9L	Complete Assembly, SOHC, Includes Front Pipe, California Emissions	4287 <sup>⑤</sup>	2504 <sup>⑤</sup>
96-99	4	1.9L	Complete Assembly, SOHC, Includes Front Pipe, Federal Emissions	4243 <sup>④</sup>	2504 <sup>④</sup>
1998	4	1.9L	2 Piece Design, Federal Emissions, SOHC, Use Aftermarket Front Pipe 38857 or Must Reuse Front Pipe, Additional sizing, bushings, cutting may be required due to OE exhaust design.	4282 <sup>④</sup> ↗	2539 <sup>④</sup>
96-98	4	1.9L	2 Piece Design, SOHC, Use Aftermarket Front Pipe 38857 or Must Reuse Front Pipe, Additional sizing, bushings, cutting may be required due to OE exhaust design.	4282 <sup>③</sup> ↗	2539 <sup>③</sup>
93-95	4	1.9L	Complete Assembly, SOHC, Includes Front Pipe	4068 <sup>③</sup>	6904 <sup>③</sup>
93-95	4	1.9L	2 Piece Design, SOHC, Use Aftermarket Front Pipe 38857 or Must Reuse Front Pipe, Additional sizing, bushings, cutting may be required due to OE exhaust design.	4282 <sup>③</sup> ↗	6904 <sup>③</sup>
<b>SATURN SC2</b>					
2002	4	1.9L	Semi Direct Fit Conv., DOHC, Must Reuse Front Pipe, additional sizing, bushings, cutting may be required due to OE exhaust design.	4282 <sup>③</sup>	2539 <sup>③</sup>
01-02	4	1.9L	Front, DOHC	1116 <sup>③</sup>	--
01-02	4	1.9L	Rear, DOHC, Includes Front Pipe	4316 <sup>③</sup>	2504 <sup>③</sup>
2001	4	1.9L	Semi Direct Fit Conv., Late Models w/DOHC, Must Reuse Front Pipe, additional sizing, bushings, cutting may be required due to OE exhaust design.	4282 <sup>③</sup>	2539 <sup>③</sup>
2001	4	1.9L	Semi Direct Fit Conv., Early Models w/DOHC, Must Reuse Front Pipe, additional sizing, bushings, cutting may be required due to OE exhaust design.	4282 <sup>③</sup>	2539 <sup>③</sup>
2000	4	1.9L	Semi Direct Fit Conv., DOHC, Must Reuse Front Pipe, additional sizing, bushings, cutting may be required due to OE exhaust design.	4282 <sup>③</sup>	2539 <sup>③</sup>
99-00	4	1.9L	Front, DOHC, California Emissions	1116 <sup>⑤</sup>	--
1999	4	1.9L	Semi Direct Fit Conv., DOHC, Must Reuse Front Pipe, additional sizing, bushings, cutting may be required due to OE exhaust design.	4282 <sup>③</sup>	2539 <sup>③</sup>
1998	4	1.9L	2 Piece Design, Federal Emissions, DOHC, Use Aftermarket Front Pipe 38858 or Must Reuse Front Pipe, Additional sizing, bushings, cutting may be required due to OE exhaust design.	4282 <sup>④</sup> ↗	2539 <sup>④</sup>
96-98	4	1.9L	Complete Assembly, DOHC, Includes Front Pipe, Federal Emissions	4854 <sup>④</sup>	2504 <sup>④</sup>

③ Federal & California Emissions. Not For Sale or Use on vehicles licensed in the state of CA & NY (NY vehicles with CA Emissions). Check with your state authority for details.

④ Federal Emissions. Not For Sale or Use on vehicles licensed in the state of CA. Check with your state authority.

⑤ California Emissions. Not For Sale or Use on vehicles licensed in the state of CA & NY. Check with your state authority.

↗ Use Aftermarket Front Pipe 38857 or Must Reuse Front Pipe

↗ Use Aftermarket Front Pipe 38858 or Must Reuse Front Pipe

YR/YRS	CYL	LITER	DESCRIPTION	DIRECT FIT	UNIVERSAL
<b>SATURN SC2 (Cont.)</b>					
96-97	4	1.9L	Semi Direct Fit Conv., Federal Emissions & Calif. Emissions NB6, DOHC, Use Aftermarket Front Pipe 38858 or Must Reuse Front Pipe, additional sizing, bushings, cutting may be required due to OE exhaust design.	4282 ③⌘ -- --	2539③ -- --
93-95	4	1.9L	Complete Assembly, DOHC, Includes Front Pipe	4402 ③	6904③
93-95	4	1.9L	2 Piece Design, DOHC, Use Aftermarket Front Pipe 38858 or Must Reuse Front Pipe, Additional sizing, bushings, cutting may be required due to OE exhaust design.	4282 ③⌘ -- --	6904③ -- --
<b>SATURN SL / SL1</b>					
01-02	4	1.9L	Semi Direct Fit Conv., SOHC, Must Reuse Front Pipe, additional sizing, bushings, cutting may be required due to OE exhaust design.	4282 ③ --	2539③ --
01-02	4	1.9L	Front, SOHC	1139 ③	--
01-02	4	1.9L	Rear, SOHC, Includes Front Pipe	4339 ③	2505③
2000	4	1.9L	Semi Direct Fit Conv., SOHC, Must Reuse Front Pipe, additional sizing, bushings, cutting may be required due to OE exhaust design.	4282 ③ --	2539③ --
1999	4	1.9L	Semi Direct Fit Conv., Federal Emissions, SOHC, Use Aftermarket Front Pipe 38857 or Must Reuse Front Pipe, additional sizing, bushings, cutting may be required due to OE exhaust design.	4282 ④⋄ -- --	2539④ -- --
98-99	4	1.9L	Complete Assembly, SOHC, Includes Front Pipe, California Emissions	4287 ⑤ --	2504⑤ --
96-99	4	1.9L	Complete Assembly, SOHC, SL1, Includes Front Pipe, Federal Emissions	4243 ④ --	2504③ --
1998	4	1.9L	2 Piece Design, Federal Emissions, SOHC, Use Aftermarket Front Pipe 38857 or Must Reuse Front Pipe, Additional sizing, bushings, cutting may be required due to OE exhaust design.	4282 ④⋄ -- --	2539④ -- --
96-97	4	1.9L	2 Piece Design, SOHC, Use Aftermarket Front Pipe 38857 or Must Reuse Front Pipe, Additional sizing, bushings, cutting may be required due to OE exhaust design.	4282 ③⋄ -- --	2539③ -- --
93-95	4	1.9L	Complete Assembly, SOHC, Includes Front Pipe	4068 ③	6904③
93-95	4	1.9L	2 Piece Design, SOHC, Use Aftermarket Front Pipe 38857 or Must Reuse Front Pipe, Additional sizing, bushings, cutting may be required due to OE exhaust design.	4282 ③⋄ -- --	6904③ -- --
91-92	4	1.9L		--	6905③
<b>SATURN SL2</b>					
01-02	4	1.9L	Semi Direct Fit Conv., DOHC, Must Reuse Front Pipe, additional sizing, bushings, cutting may be required due to OE exhaust design.	4282 ③ --	2539③ --
01-02	4	1.9L	Front, DOHC	1116 ③	--
01-02	4	1.9L	Rear, DOHC, Includes Front Pipe	4316 ③	2504③
2000	4	1.9L	Semi Direct Fit Conv., DOHC, Must Reuse Front Pipe, additional sizing, bushings, cutting may be required due to OE exhaust design.	4282 ③ --	2539③ --
99-00	4	1.9L	Complete Assembly, DOHC, SL2, Includes Front Pipe, Federal Emissions	4210 ④ --	2504R④ --
99-00	4	1.9L	Front, DOHC, California Emissions	1116 ⑤	--
1999	4	1.9L	Semi Direct Fit Conv., DOHC, Must Reuse Front Pipe, additional sizing, bushings, cutting may be required due to OE exhaust design.	4282 ③ --	2539③ --

③ Federal & California Emissions. Not For Sale or Use on vehicles licensed in the state of CA & NY (NY vehicles with CA Emissions). Check with your state authority for details.

④ Federal Emissions. Not For Sale or Use on vehicles licensed in the state of CA. Check with your state authority.

⑤ California Emissions. Not For Sale or Use on vehicles licensed in the state of CA & NY. Check with your state authority.

⋄ Use Aftermarket Front Pipe 38857 or Must Reuse Front Pipe

⌘ Use Aftermarket Front Pipe 38858 or Must Reuse Front Pipe

**APPLICATION LISTINGS  
FEDERAL CONVERTERS**



YR/YRS	CYL	LITER	DESCRIPTION	DIRECT FIT	UNIVERSAL
<b>SATURN SL2 (Cont.)</b>					
1998	4	1.9L	2 Piece Design, Federal Emissions, DOHC, Use Aftermarket Front Pipe 38858 or Must Reuse Front Pipe, Additional sizing, bushings, cutting may be required due to OE exhaust design.	4282 ④⌘	2539④
96-98	4	1.9L	Complete Assembly, DOHC, Includes Front Pipe, Federal Emissions	4854 ④	2504④
96-97	4	1.9L	Semi Direct Fit Conv., Federal Emissions & Calif. Emissions NB6, DOHC, Use Aftermarket Front Pipe 38858 or Must Reuse Front Pipe, additional sizing, bushings, cutting may be required due to OE exhaust design.	4282 ③⌘	2539③
93-95	4	1.9L	Complete Assembly, DOHC, Includes Front Pipe	4402 ③	6904③
93-95	4	1.9L	2 Piece Design, DOHC, Use Aftermarket Front Pipe 38858 or Must Reuse Front Pipe, Additional sizing, bushings, cutting may be required due to OE exhaust design.	4282 ③⌘	6904③
91-92	4	1.9L	For use with OE intermediate pipe, additional sizing, bushings, cutting may be required due to OE exhaust design.	--	6905③
91-92	4	1.9L		--	6905③
<b>SATURN SW1</b>					
1999	4	1.9L	Semi Direct Fit Conv., Federal Emissions, SOHC, Use Aftermarket Front Pipe 38857 or Must Reuse Front Pipe, additional sizing, bushings, cutting may be required due to OE exhaust design.	4282 ③↗	2539③
98-99	4	1.9L	Complete Assembly, SOHC, Includes Front Pipe, California Emissions	4287 ⑤	2504⑤
96-99	4	1.9L	Complete Assembly, SOHC, Includes Front Pipe, Federal Emissions	4243 ④	2504③
1998	4	1.9L	2 Piece Design, Federal Emissions, SOHC, Use Aftermarket Front Pipe 38857 or Must Reuse Front Pipe, Additional sizing, bushings, cutting may be required due to OE exhaust design.	4282 ④↗	2539④
96-97	4	1.9L	2 Piece Design, SOHC, Use Aftermarket Front Pipe 38857 or Must Reuse Front Pipe, Additional sizing, bushings, cutting may be required due to OE exhaust design.	4282 ③↗	2539③
93-95	4	1.9L	Complete Assembly, SOHC, Includes Front Pipe	4068 ③	6904③
93-95	4	1.9L	2 Piece Design, SOHC, Use Aftermarket Front Pipe 38857 or Must Reuse Front Pipe, Additional sizing, bushings, cutting may be required due to OE exhaust design.	4282 ③↗	6904③
<b>SATURN SW2</b>					
2001	4	1.9L	Semi Direct Fit Conv., DOHC, Must Reuse Front Pipe, additional sizing, bushings, cutting may be required due to OE exhaust design.	4282 ③	2539③
2001	4	1.9L	Front, DOHC	1116 ③	--
2001	4	1.9L	DOHC, Includes Front Pipe	4316 ③	2504③
2000	4	1.9L	Semi Direct Fit Conv., DOHC, Must Reuse Front Pipe, additional sizing, bushings, cutting may be required due to OE exhaust design.	4282 ③	2539③
99-00	4	1.9L	Front, DOHC, California Emissions	1116 ⑤	--
1999	4	1.9L	Semi Direct Fit Conv., DOHC, Must Reuse Front Pipe, additional sizing, bushings, cutting may be required due to OE exhaust design.	4282 ③	2539③
1998	4	1.9L	2 Piece Design, Federal Emissions, DOHC, Use Aftermarket Front Pipe 38858 or Must Reuse Front Pipe, Additional sizing, bushings, cutting may be required due to OE exhaust design.	4282 ④⌘	2539④

③ Federal & California Emissions. Not For Sale or Use on vehicles licensed in the state of CA & NY (NY vehicles with CA Emissions). Check with your state authority for details.  
 ④ Federal Emissions. Not For Sale or Use on vehicles licensed in the state of CA. Check with your state authority.  
 ⑤ California Emissions. Not For Sale or Use on vehicles licensed in the state of CA & NY. Check with your state authority.  
 ↗ Use Aftermarket Front Pipe 38857 or Must Reuse Front Pipe  
 ⌘ Use Aftermarket Front Pipe 38858 or Must Reuse Front Pipe



YR/YRS	CYL	LITER	DESCRIPTION	DIRECT FIT	UNIVERSAL
<b>SATURN SW2 (Cont.)</b>					
96-98	4	1.9L	Complete Assembly, DOHC, Includes Front Pipe, Federal Emissions	4854 ④ --	2504④ --
96-97	4	1.9L	Semi Direct Fit Conv., Federal Emissions & Calif. Emissions NB6,	4282 ③⊠	2539③
			DOHC, Use Aftermarket Front Pipe 38858 or Must Reuse Front Pipe, additional sizing, bushings, cutting may be required due to OE exhaust design.	-- -- --	-- -- --
93-95	4	1.9L	Complete Assembly, DOHC, Includes Front Pipe	4402 ③	6904③
93-95	4	1.9L	2 Piece Design, DOHC, Use Aftermarket Front Pipe 38858 or Must Reuse Front Pipe, Additional sizing, bushings, cutting may be required due to OE exhaust design.	4282 ③⊠ -- --	6904③ -- --
<b>SATURN VUE</b>					
2006	4	2.2L	Manual Trans. Manual Trans.	4290 ③ --	2574R③○ 2504R③□
02-05	4	2.2L		4290 ③ --	2574R③○ 2504R③□
08-10	4	2.4L		5217 ③	--
2007	4	2.4L	Green Line Model	5069 ③	--
02-03	6	3.0L	Front Front	1193 ③ 1183 ③⑩	-- --
02-03	6	3.0L		4983 ③	--
04-07	6	3.5L	Front Right Front Right	1251 ③ 1156 ③⑩	-- --
04-07	6	3.5L	Front Left Front Left	1250 ③ 1155 ③⑩	-- --
2006	6	3.5L	Front Left	1250 ③	--
2006	6	3.5L	Front Right	1251 ③	--
<b>SCION FR-S</b>					
2013	4	2.0L	Rear	5196 ③	--
<b>SCION TC</b>					
07-10	4	2.4L	Manifold Unit, Front	1297 ③	--
05-10	4	2.4L	Rear	5033 ③	--
07-08	4	2.4L		--	2564R③○
11-13	4	2.5L	Rear	5058 ③	--
11-13	4	2.5L	Manifold Unit, Front	1306 ③	--
<b>SCION XA</b>					
04-06	4	1.5L	XA	4326 ③	2564R③○
<b>SCION XB</b>					
04-06	4	1.5L		4806 ③	--
08-12	4	2.4L	Front	1107 ③	--
2008	4	2.4L		--	2564R③○
<b>SCION XD</b>					
08-12	4	1.8L		5046 ③	--
<b>SMART FORTWO</b>					
2009	3	1.0L		--	2573R③○
<b>STERLING 825</b>					
87-88	6	2.5L		--	6904R③

⊙ Discontinued, use until inventory is depleted.

③ Federal & California Emissions. Not For Sale or Use on vehicles licensed in the state of CA & NY (NY vehicles with CA Emissions). Check with your state authority for details.

④ Federal Emissions. Not For Sale or Use on vehicles licensed in the state of CA. Check with your state authority.

⊠ Use Aftermarket Front Pipe 38858 or Must Reuse Front Pipe

218 □ EPA OBDII By Design Unit

○ EPA Enhanced OBDII By Design Unit

**APPLICATION LISTINGS  
FEDERAL CONVERTERS**



YR/YRS	CYL	LITER	DESCRIPTION	DIRECT FIT	UNIVERSAL
<b>STERLING 827</b>					
89-91	6	2.7L		--	6904R <sup>③</sup>
<b>SUBARU B9 TRIBECA</b>					
06-07	6	3.0L	Manifold Unit, Right	5048 <sup>③</sup>	--
06-07	6	3.0L	Manifold Unit, Left	5047 <sup>③</sup>	--
<b>SUBARU BAJA</b>					
03-06	4	2.5L	Naturally Aspirated	4181 <sup>③</sup>	--
2003	4	2.5L	Federal Emissions	4217 <sup>④⑩</sup>	--
<b>SUBARU BRAT</b>					
84-87	4	1.8L	(Exc. Turbo), Rear	--	6004 <sup>③</sup>
83-84	4	All	Turbo, Front	--	6804 <sup>③</sup>
<b>SUBARU COUPE - 3 Dr.</b>					
88-89	4	1.8L	Front, Turbo	--	6804 <sup>③</sup>
88-89	4	1.8L	Rear, Turbo, w/Air Tube	--	6004 <sup>③</sup>
88-89	4	1.8L	Rear, Turbo, w/o Air Tube	4620 <sup>③</sup>	6904 <sup>③</sup>
87-89	4	1.8L	Rear, (Exc. Turbo or California Emissions 4WD)	--	6904 <sup>③</sup>
87-89	4	1.8L	Rear, California Emissions, 4WD, (Exc. Turbo)	4620 <sup>⑤</sup>	6904 <sup>⑤</sup>
1986	4	1.8L	Front, Turbo	--	6804 <sup>③</sup>
1986	4	1.8L	Rear, 2WD, (Exc. Turbo)	--	6004 <sup>③</sup>
1986	4	1.8L	Rear, 4WD Turbo, w/Air Tube	--	6004 <sup>③</sup>
1986	4	1.8L	Rear, 4WD Turbo, w/o Air Tube	4620 <sup>③</sup>	6904 <sup>③</sup>
<b>SUBARU FORESTER</b>					
09-13	4	2.5L	Turbocharged, Rear	5169 <sup>③</sup>	--
06-10	4	2.5L	Naturally Aspirated, Manifold Unit, Front	5107 <sup>③</sup>	--
			Naturally Aspirated, Manifold Unit, Front	4442 <sup>③⑩</sup>	--
06-08	4	2.5L	Rear, (Exc. Turbo)	4443 <sup>③</sup>	2575R <sup>③○</sup>
99-05	4	2.5L	Naturally Aspirated	4217 <sup>④⑩</sup>	--
			Naturally Aspirated	4181 <sup>③</sup>	--
1998	4	2.5L	Front	4064 <sup>③</sup>	2554 <sup>③○</sup>
1998	4	2.5L		4367 <sup>③</sup>	2538 <sup>③</sup>
<b>SUBARU HATCHBACK</b>					
85-89	4	1.8L	Front	4025 <sup>③</sup>	--
83-89	4	All	Rear, w/Air Tube	--	6004 <sup>③</sup>
83-89	4	All	Rear, w/o Air Tube	--	6904 <sup>③</sup>
83-84	4	All	Front, w/Turbo	--	6804 <sup>③</sup>
80-82	4	All	Rear, (Exc. 4WD)	--	6904 <sup>③</sup>
80-82	4	All	Rear, 4WD	--	6004 <sup>③</sup>
<b>SUBARU IMPREZA</b>					
96-97	4	1.8L	Front	4366 <sup>③</sup>	2554 <sup>③○</sup>
96-97	4	1.8L		4894 <sup>③</sup>	2538 <sup>③</sup>
93-95	4	1.8L	Front	4893 <sup>③</sup>	--
93-95	4	1.8L		4894 <sup>③</sup>	6804 <sup>③</sup>
95-01	4	2.2L	Front	4366 <sup>③</sup>	2554 <sup>③○</sup>
95-01	4	2.2L		4367 <sup>③</sup>	2538 <sup>③</sup>
08-14	4	2.5L	Turbocharged, Rear	5169 <sup>③</sup>	--
08-12	4	2.5L	WRX Sti, Turbocharged, Front	5168 <sup>③</sup>	--
06-11	4	2.5L	Naturally Aspirated, Manifold Unit, Front	5107 <sup>③</sup>	--
			Naturally Aspirated, Manifold Unit, Front	4442 <sup>③⑩</sup>	--

- ⑩ Discontinued, use until inventory is depleted.
- ③ Federal & California Emissions. Not For Sale or Use on vehicles licensed in the state of CA & NY (NY vehicles with CA Emissions). Check with your state authority for details.
- ④ Federal Emissions. Not For Sale or Use on vehicles licensed in the state of CA. Check with your state authority.
- ⑤ California Emissions. Not For Sale or Use on vehicles licensed in the state of CA & NY. Check with your state authority.
- EPA Enhanced OBDII By Design Unit

YR/YRS	CYL	LITER	DESCRIPTION	DIRECT FIT	UNIVERSAL
<b>SUBARU IMPREZA (Cont.)</b>					
06-07	4	2.5L	Rear, (Exc. Turbo)	4443 ③	2575R③○
04-07	4	2.5L	WRX Sti, Turbo, Front	4721 ③	--
04-06	4	2.5L	WRX Sti, Turbo, Rear	4769 ③	--
99-05	4	2.5L	Naturally Aspirated	4181 ③	--
99-05	4	2.5L	Federal Emissions	4217 ④⑩	--
1998	4	2.5L	Front, RS Coupe	4366 ③	2554③○
1998	4	2.5L	Rear, RS Coupe	4367 ③	2538③
<b>SUBARU JUSTY</b>					
87-94	3	1.2L		--	6904③
<b>SUBARU LEGACY</b>					
95-99	4	2.2L	Front	4366 ③	2554③
95-99	4	2.2L		4367 ③	2538③
90-94	4	2.2L	Front, (Exc. Turbo)	4832 ③	--
90-94	4	2.2L	Rear, (Exc. Turbo)	4842 ③	6904③
06-09	4	2.5L	Naturally Aspirated, Manifold Unit, Front	5107 ③	--
05-09	4	2.5L	Turbocharged, Standard Trans., Rear	5169 ③	--
06-07	4	2.5L	Naturally Aspirated, Rear	5057 ③	--
04-05	4	2.5L	Naturally Aspirated, Vehicles w/ 3 Converter Bodies, California Emissions, Right	4578 ⑤	--
04-05	4	2.5L	Naturally Aspirated, Vehicles w/ 3 Converter Bodies, California Emissions, Left	--	--
00-05	4	2.5L	Naturally Aspirated, Vehicles w/ 2 Converter Bodies	4181 ③	--
01-03	4	2.5L	Federal Emissions	4217 ④⑩	--
96-02	4	2.5L	Front	4366 ③	2554③
96-02	4	2.5L		4367 ③	2538③
<b>SUBARU LOYALE</b>					
90-94	4	1.8L	Front, (Exc. Turbo)	4025 ③	--
90-94	4	1.8L	Rear, (Exc. Turbo)	4620 ③	6904③
1990	4	1.8L	Front, Turbo	--	6804③
1990	4	1.8L	Rear, Turbo	--	6904③
<b>SUBARU OUTBACK</b>					
06-11	4	2.5L	Naturally Aspirated, Manifold Unit, Front	5107 ③	--
05-09	4	2.5L	Turbocharged, Standard Trans., Rear	5169 ③	--
06-07	4	2.5L	Naturally Aspirated, Rear	5057 ③	--
04-05	4	2.5L	Naturally Aspirated, Vehicles w/ 3 Converter Bodies, California Emissions, Right	4578 ⑤	--
04-05	4	2.5L	Naturally Aspirated, Vehicles w/ 3 Converter Bodies, California Emissions, Left	5017 ⑤	--
00-05	4	2.5L	Naturally Aspirated, Vehicles w/ 2 Converter Bodies	4181 ③	--
01-03	4	2.5L	Federal Emissions	4217 ④⑩	--
2000	4	2.5L	Front Conv.	4366 ③	2554③○
2000	4	2.5L	Rear Conv.	4367 ③	2538③
05-07	6	3.0L	Manifold Unit, Right	5048 ③	--
05-07	6	3.0L	Manifold Unit, Left	5047 ③	--
01-04	6	3.0L	Right	4624 ③	--
01-04	6	3.0L	Left	4625 ③	--

⑩ Discontinued, use until inventory is depleted.

③ Federal & California Emissions. Not For Sale or Use on vehicles licensed in the state of CA & NY (NY vehicles with CA Emissions). Check with your state authority for details.

④ Federal Emissions. Not For Sale or Use on vehicles licensed in the state of CA. Check with your state authority.

⑤ California Emissions. Not For Sale or Use on vehicles licensed in the state of CA & NY. Check with your state authority.

**APPLICATION LISTINGS  
FEDERAL CONVERTERS**



YR/YRS	CYL	LITER	DESCRIPTION	DIRECT FIT	UNIVERSAL
<b>SUBARU SEDAN - 4 Dr.</b>					
83-84	4	1.6L	Rear, California Emissions, 4WD, (Exc. Turbo)	--	6904⑤
87-89	4	1.8L	Rear, 2WD, (Exc. Turbo)	--	6904③
85-89	4	1.8L	Front, (Exc. Turbo)	4025 ③	--
85-89	4	1.8L	Front, Turbo	--	6804③
85-89	4	1.8L	Rear, California Emissions, 4WD, (Exc. Turbo)	4620 ⑤	6904⑤
85-89	4	1.8L	Rear, Turbo, 4WD	4620 ③	6904③
85-86	4	1.8L	Rear, California Emissions, 2WD, (Exc. Turbo)	--	6904⑤
85-86	4	1.8L	Rear, 2WD, (Exc. Turbo)	--	6004③
83-84	4	1.8L	Front, Turbo	--	6804③
83-84	4	1.8L	Rear, California Emissions, 4WD, (Exc. Turbo)	--	6904⑤
83-84	4	1.8L	Rear, Turbo, 4WD	--	6004③
1984	4	All	Rear, 2WD, (Exc. Turbo)	--	6904③
83-84	4	All	Rear, California Emissions, 2WD	--	6904⑤
1983	4	All	Rear, 2WD, (Exc. Turbo)	--	6004③
80-82	4	All	Rear, (Exc. 4WD)	--	6904③
<b>SUBARU STATION WAGON</b>					
83-84	4	1.6L	Rear, 4WD California Emissions, (Exc. Turbo)	--	6904⑤
87-89	4	1.8L	Rear, 2WD	--	6904③
85-89	4	1.8L	Front, (Exc. Turbo)	4025 ③	--
85-89	4	1.8L	Front, Turbo	--	6804③
85-89	4	1.8L	Rear, 4WD, Turbo	4620 ③	6904③
85-86	4	1.8L	Rear, 2WD, (Exc. Turbo)	--	6904③
85-86	4	1.8L	Rear, 2WD California Emissions, (Exc. Turbo)	--	6904⑤
83-84	4	1.8L	Front, Turbo	--	6804③
83-84	4	1.8L	Rear, Turbo, 4WD	--	6004③
1984	4	All	Rear, 2WD, (Exc. Turbo)	--	6904③
83-84	4	All	Rear, 2WD, California Emissions	--	6904⑤
83-84	4	All	Rear, 4WD, California Emissions, (Exc. Turbo)	--	6904⑤
1983	4	All	Rear, 2WD, (Exc. Turbo)	--	6004③
1982	4	All		--	6904③
80-81	4	All	Rear, 4WD	--	6904③
<b>SUBARU SVX</b>					
1996	6	3.3L	Front Right	--	2504③
1996	6	3.3L	Front Left	--	2504③
1996	6	3.3L		--	2513③
1995	6	3.3L	Front Right	--	2504③
1995	6	3.3L	Front Left	--	2504③
1995	6	3.3L		--	2513③
92-94	6	3.3L	Front Right	--	6904R③
92-94	6	3.3L	Front Left	--	6904R③
92-94	6	3.3L		--	2613W③
<b>SUBARU XT</b>					
85-90	4	1.8L	Front, (Exc. Turbo)	4025 ③	--
85-90	4	1.8L	Rear, (Exc. Turbo)	4620 ③	6904③
85-87	4	1.8L	Front, Turbo	--	6904③
85-87	4	1.8L	Rear, Turbo	--	6904③
88-91	6	2.7L	XT-6, Rear	--	6904③

⑤ Federal & California Emissions. Not For Sale or Use on vehicles licensed in the state of CA & NY (NY vehicles with CA Emissions). Check with your state authority for details.  
 ③ California Emissions. Not For Sale or Use on vehicles licensed in the state of CA & NY. Check with your state authority.

YR/YRS	CYL	LITER	DESCRIPTION	DIRECT FIT	UNIVERSAL
<b>SUZUKI AERIO</b>					
02-03	4	2.0L	Front	--	2504R③
02-03	4	2.0L		1190 ③	--
04-07	4	2.3L		--	2564R③○
<b>SUZUKI EQUATOR</b>					
09-12	4	2.5L	Manifold Unit, Front	1304 ③	--
<b>SUZUKI ESTEEM</b>					
95-01	4	1.6L	Front	1115 ③	--
95-01	4	1.6L		4315 ③	2504R③
99-02	4	1.8L	Front	1215 ③	--
99-02	4	1.8L		4315 ③	2504R③
<b>SUZUKI FORENZA</b>					
04-08	4	2.0L	Front Conv.	4804 ③	--
04-05	4	2.0L	Rear Conv., Requires 38010 Front Pipe to Complete Installation	4699 ③	2575R③
<b>SUZUKI FORSA</b>					
87-88	3	1.0L	Turbo (Canada Model)	--	6904③
86-88	3	1.0L	(Exc. Turbo) (Canada Model)	--	6904③
<b>SUZUKI RENO</b>					
05-08	4	2.0L	Front Conv.	4804 ③	--
2005	4	2.0L	Rear Conv., Requires 38010 Front Pipe to Complete Installation	4699 ③	2575R③
<b>SUZUKI SAMURAI</b>					
86-94	4	1.3L		4301 ③	6904③
<b>SUZUKI SIDEKICK</b>					
96-98	4	1.6L		4174 ③	2539③
93-95	4	1.6L	16 valve, Hardtop Models	4790 ☆③	2904③
93-95	4	1.6L	4 Dr., (Exc. 16 valve)	--	2904③
89-92	4	1.6L		4467 ③	6905③
96-98	4	1.8L		4174 ③	2539③
<b>SUZUKI SWIFT</b>					
98-01	4	1.3L	Front, California Emissions, Includes Pipe Between Converters	1042 ⑤	--
98-01	4	1.3L	Rear, California Emissions	4342 ⑤	2538⑤
95-97	4	1.3L	SOHC	--	2504③
1994	4	1.3L	DOHC	--	6904③
89-94	4	1.3L	SOHC, Manual Trans.	4170 ③	6904③
1993	4	1.3L	DOHC, Federal Emissions	--	6904④
1993	4	1.3L	DOHC, California Emissions	--	6904R⑤
89-92	4	1.3L	DOHC	--	6904③
89-92	4	1.3L	SOHC, Auto Trans.	4669 ③	6903③
<b>SUZUKI SX4</b>					
07-09	4	2.0L	Front	5165 ③	--
07-09	4	2.0L	Rear	5039 ③	--
<b>SUZUKI VERONA</b>					
04-06	6	2.5L	Manifold Unit, Right	1275 ③	--
04-06	6	2.5L	Manifold Unit, Left	1276 ③	--
<b>SUZUKI VITARA, GRAND VITARA</b>					
99-02	4	1.6L		4174 ③	2514③
99-01	4	1.6L	Front, California Emissions	1074 ⑤	--
99-03	4	2.0L		4174 ③	2514③

☆ Air Tube kit 4948 may be required for installation.

③ Federal & California Emissions. Not For Sale or Use on vehicles licensed in the state of CA & NY (NY vehicles with CA Emissions). Check with your state authority for details.

④ Federal Emissions. Not For Sale or Use on vehicles licensed in the state of CA. Check with your state authority.

⑤ California Emissions. Not For Sale or Use on vehicles licensed in the state of CA & NY. Check with your state authority.

○ EPA Enhanced OBDII By Design Unit

**APPLICATION LISTINGS**  
**FEDERAL CONVERTERS**



YR/YRS	CYL	LITER	DESCRIPTION	DIRECT FIT	UNIVERSAL
<b>SUZUKI VITARA, GRAND VITARA (Cont.)</b>					
99-03	4	2.0L	Front, California Emissions	1074 ⑤	--
99-05	6	2.5L	Right Manifold Conv.	1135 ③	--
99-05	6	2.5L	Manifold Unit, Left	1134 ③	--
99-00	6	2.5L	Grand Vitara Models	--	2540③
06-08	6	2.7L	Manifold Unit, Front Right	1314 ③	--
06-08	6	2.7L	Manifold Unit, Front Left	1313 ③	--
06-08	6	2.7L	Center	5200 ③	--
<b>SUZUKI X90</b>					
96-98	4	1.6L		4174 ③	2539③
<b>SUZUKI XL-7</b>					
04-06	6	2.7L	Manifold Unit, Front Right	1314 ③	--
04-06	6	2.7L	Manifold Unit, Front Left	1313 ③	--
04-06	6	2.7L	Center	5209 ③	--
02-03	6	2.7L	4WD, Auto. Trans., Federal Emissions, Rear Main Conv.	9262 ④	2516④
07-08	6	3.6L	Front Conv.	4444 ③	2575③○
07-08	6	3.6L	Rear Conv.	4445 ③	2575③○
<b>TOYOTA 4 RUNNER</b>					
1995	4	2.4L		--	2904③
90-94	4	2.4L		4377 ③	6904③
84-89	4	2.4L		4377 ③	6904③
99-00	4	2.7L	Federal Emissions	4768 ④	2574④
96-98	4	2.7L		4768 ③	2574③
94-95	6	3.0L		4408 ③	6905③
88-93	6	3.0L		4408 ③	6905③
01-02	6	3.4L	Federal Emissions, Rear	5156 ④	--
99-02	6	3.4L	Front, California Emissions	1053 ⑤	--
99-02	6	3.4L	Rear, California Emissions	9153 ⑤	--
96-00	6	3.4L	Federal Emissions	9023 ④	2540④
03-12	6	4.0L	To 08/12, Rear Left	4499 ③	--
03-12	6	4.0L	To 08/12, Rear Right	4498 ③	--
03-09	6	4.0L	Front Left	1149 ③	2575R③○
03-09	6	4.0L	Front Right	1150 ③	2575R③○
05-09	8	4.7L	Rear Right	4732 ③	2574R③
05-09	8	4.7L	Rear Left	4917 ③	2574R③
05-09	8	4.7L	Front Right	1214 ③	--
05-09	8	4.7L	Front Left	1213 ③	--
03-04	8	4.7L	Rear Main	4507 ③	2575R③○
03-04	8	4.7L	Manifold Unit, Front Right	1336 ③	--
03-04	8	4.7L	Manifold Unit, Front Left	1335 ③	--
<b>TOYOTA AVALON</b>					
00-04	6	3.0L	Middle Conv.	4476 ③	--
00-04	6	3.0L		4477 ③	--
96-04	6	3.0L	Front Manifold Conv., California Emissions, USA Built	1076 ⑤	--
97-99	6	3.0L	Federal Emissions, USA Built	4835 ④	2538④
96-99	6	3.0L	California Emissions, USA Built	4259 ⑤	--
95-96	6	3.0L	Federal Emissions, USA Built; From 9/94 To 8/96	4976 ④	2538④
09-12	6	3.5L	To 11/2011, Front Manifold Conv.	1158 ③	--

- ③ Federal & California Emissions. Not For Sale or Use on vehicles licensed in the state of CA & NY (NY vehicles with CA Emissions). Check with your state authority for details.
- ④ Federal Emissions. Not For Sale or Use on vehicles licensed in the state of CA. Check with your state authority.
- ⑤ California Emissions. Not For Sale or Use on vehicles licensed in the state of CA & NY. Check with your state authority.
- EPA Enhanced OBDII By Design Unit

YR/YRS	CYL	LITER	DESCRIPTION	DIRECT FIT	UNIVERSAL
<b>TOYOTA AVALON (Cont.)</b>					
06-12	6	3.5L	To 11/2011, Rear Manifold Conv.	1157 ③	--
06-08	6	3.5L	With L31160 stamped in OE Conv. heat shield and straight bracket at outlet, Front Manifold Conv.	1159 ③	--
06-08	6	3.5L	With LOP040 stamped in OE Conv. heat shield and angled bracket at outlet, Front Manifold Conv.	1158 ③	--
05-07	6	3.5L	Rear Main Conv.	4757 ③	--
2005	6	3.5L	Manifold Unit, Front	1158 ③	--
2005	6	3.5L	Rear Manifold Conv.	1157 ③	--
<b>TOYOTA CAMRY, (Inc. 1998 &amp; Older SOLARA)</b>					
88-91	4	2.0L	Front, All Trac	1067 ③	--
88-91	4	2.0L	Rear, All Trac	--	6905R③
87-91	4	2.0L	Sedan & Station Wgn.	1067 ③	--
83-86	4	2.0L		4377 ③	6904③
97-01	4	2.2L	Federal Emissions	4061 ④	2505R④
97-01	4	2.2L	US Built, California Emissions, Front	1061 ⑤	--
97-01	4	2.2L	US Built, California Emissions, Rear	4061 ⑤	2505R⑤
94-96	4	2.2L	Front	1001 ③	--
94-96	4	2.2L	Rear, Sedan, Station Wgn.	4812 ③	6804③
92-93	4	2.2L		4087 ③	6906③
92-93	4	2.2L	Rear, California Emissions	4087 ⑤	6906⑤
07-09	4	2.4L	US Built, Rear	4320 ③	2565R③○
07-09	4	2.4L	Federal Emissions, Front Manifold Conv.	1198 ④	--
07-09	4	2.4L	California Emissions, Front Manifold Conv.	1199 ⑤	--
03-06	4	2.4L	PZEV & SULEV, Rear	5023 ③	2576R③
02-06	4	2.4L	US Built, California Emissions, Front	1120 ⑤	--
02-06	4	2.4L	US Built, California Emissions, ULEV Only, Rear	4320 ⑤	2565R⑤
12-16	4	2.5L	Rear Conv., Requires Resonator Pipe 38015 to Complete Installation, As OE was a One Piece Welded Assembly	4011 ③	2575③
10-11	4	2.5L	U.S. Built, Federal Emissions, Rear	5006 ④	--
88-91	6	2.5L		4408 ③	6905③
02-06	6	3.0L	Rear Main, USA Built, Auto Trans.	4383 ③	2574R③○
02-06	6	3.0L	Rear Main, USA Built, Auto Trans.	--	2564R③□
02-06	6	3.0L	Manifold Unit, Front	1170 ③	--
02-06	6	3.0L	Rear Manifold Conv.	1172 ③	--
97-02	6	3.0L	Manual Trans., Federal Emissions	4388 ④	2516④
96-01	6	3.0L	Rear Main, US Built, Auto Trans., California Emissions	4259 ⑤	--
96-01	6	3.0L	Front Manifold Conv., California Emissions	1076 ⑤	--
97-00	6	3.0L	USA Built, Auto Trans., Federal Emissions; To 8/00	4835 ④	2506R④
95-96	6	3.0L	USA Built, Auto Trans., Federal Emissions;	4976 ④	2538④
92-94	6	3.0L	To 8/94	4087 ③	6906③
04-06	6	3.3L	Rear Main, USA Built, Auto Trans.	4383 ③○	2574R③○
04-06	6	3.3L	Rear Manifold Conv.	1173 ③	--
04-06	6	3.3L	Manifold Unit, Front	1171 ③	--
10-11	6	3.5L	Manifold Unit, Front	1158 ③	--
07-11	6	3.5L	Rear Manifold Conv.	1157 ③	--
07-09	6	3.5L	Manifold Unit, Front	1159 ③	--

③ Federal & California Emissions. Not For Sale or Use on vehicles licensed in the state of CA & NY (NY vehicles with CA Emissions). Check with your state authority for details.

④ Federal Emissions. Not For Sale or Use on vehicles licensed in the state of CA. Check with your state authority.

⑤ California Emissions. Not For Sale or Use on vehicles licensed in the state of CA & NY. Check with your state authority.

□ EPA OBDII By Design Unit

224 ○ EPA Enhanced OBDII By Design Unit

# APPLICATION LISTINGS

## FEDERAL CONVERTERS



YR/YRS	CYL	LITER	DESCRIPTION	DIRECT FIT	UNIVERSAL
<b>TOYOTA CELICA</b>					
90-93	4	1.6L		4087 ③	6906③
00-05	4	1.8L	GT	5019 ③	2575R③
1997	4	1.8L	ST Liftback & Sport Coupe	4883 ③	2540③
1996	4	1.8L		4883 ③	2540③
94-95	4	1.8L		--	6904R③
88-90	4	2.0L	All Trac; From 10/87	--	6905R③
86-89	4	2.0L	DOHC, (Exc. All Trac)	4087 ③	6906③
1986	4	2.0L	SOHC	4377 ③	6904③
90-93	4	2.2L		1067 ③	--
84-85	4	2.4L		4377 ③	6904③
79-80	4	All		4377 ③	6904③
76-78	4	All		--	6904③
<b>TOYOTA COROLLA</b>					
96-97	4	1.6L		4883 ③	2539③
93-95	4	1.6L		4377 ③	6904③
90-92	4	1.6L	All Trac	--	6904R③
88-91	4	1.6L	(Exc. All Trac)	4377 ③	6904③
87-88	4	1.6L	FX Models, w/o Air Tube	4377 ③	6904③
87-88	4	1.6L	FX Models, w/Air Tube	--	6004③
06-08	4	1.8L	USA Built, Requires Resonator Pipe #58494 to Complete Installation	4805 ③	--
2005	4	1.8L	XRS, Requires Resonator Pipe #58494 to Complete Installation	4805 ③	--
03-05	4	1.8L	To 04/05, Exc. XRS, Requires Resonator Pipe # 68432 to Complete Installation	4805 ③	--
03-04	4	1.8L	Complete Assembly including Resonator Pipe	4274 ③	--
98-02	4	1.8L		4043 ③	2504R③
96-97	4	1.8L		4883 ③	2539③
93-95	4	1.8L		4377 ③	6904③
09-10	4	2.4L	Manifold Unit, Front	1297 ③	--
09-10	4	2.4L	US Built, XRS, Rear, OE is a Welded Assembly, 68542 Pipe Required to Complete Installation	5124 ③	--
83-89	4	All	w/Air Tube on Right	4070 ☆③	6004③
83-86	4	All	w/Air Tube on Left	--	6004③
83-86	4	All	w/o Air Tube	4377 ③	6904③
76-80	4	All	w/o Thermo Sensor Port	4377 ③	6904③
1975	4	All		--	6904③
<b>TOYOTA CORONA</b>					
79-80	4	2.2L		4377 ③	6904③
81-82	4	2.4L		4377 ③	6904③
<b>TOYOTA CRESSIDA</b>					
85-88	6	2.8L		4377 ③	6904③
83-84	6	2.8L	w/o Thermo Sensor Port	4377 ③	6904③
89-92	6	3.0L	(Exc. Manifold Mounted Conv.)	4087 ③	6906③
78-82	6	All		4377 ③	6904③
<b>TOYOTA ECHO</b>					
00-05	4	1.5L		4326 ③	2564R③○

☆ Air Tube kit 4948 may be required for installation.

③ Federal & California Emissions. Not For Sale or Use on vehicles licensed in the state of CA & NY (NY vehicles with CA Emissions). Check with your state authority for details.

○ EPA Enhanced OBDII By Design Unit



YR/YRS	CYL	LITER	DESCRIPTION	DIRECT FIT	UNIVERSAL
<b>TOYOTA FJ CRUISER</b>					
07-12	6	4.0L	Rear Right	4498 ③	--
07-12	6	4.0L	Rear Left	4499 ③	--
07-09	6	4.0L	Front Left	1149 ③	--
07-09	6	4.0L	Front Right	1150 ③	--
<b>TOYOTA HIGHLANDER</b>					
04-07	4	2.4L	Manifold Unit, Front	1311 ③	--
04-06	4	2.4L	Rear	5197 ③	--
01-03	4	2.4L		4532 ③	--
11-12	4	2.7L	Rear, Japan Built, Requires Welded Assembly 70002 to Complete Installation, As OE was a One Piece Welded Assembly	4697 ③	--
09-12	4	2.7L	Front	4698 ③	--
09-10	4	2.7L	Rear, Requires Welded Assembly 70002 to Complete Installation, As OE was a One Piece Welded Assembly	4697 ③	--
01-03	6	3.0L	Front Conv.	1032 ③	--
01-03	6	3.0L	Rear Conv.	1033 ③	--
01-03	6	3.0L	Rear Main	4232 ③	--
08-10	6	3.3L	Rear, Requires Welded Assembly 60006 to Complete Installation, As OE was a One Piece Welded Assembly	4696 ③	--
06-10	6	3.3L	Hybrid, Hybrid Limited, Manifold Unit, Front Right	1296 ③	--
06-07	6	3.3L	Front Manifold Conv., Exc. Hybrid Models	1114 ③	--
06-07	6	3.3L	Rear Manifold Conv., Exc. Hybrid Models	1119 ③	--
06-07	6	3.3L	Main Conv., Exc. Hybrid Models, Due to O.E. design, #8 bushing or sizing with aftermarket pipe may be required.	9224 ③	--
06-07	6	3.3L	Hybrid, Rear, Requires Welded Assembly 7885 to Complete Installation	4004 ③	2574R③
04-05	6	3.3L	Manifold Unit, Front	1114 ③	--
04-05	6	3.3L	Rear Manifold Conv.	1119 ③	--
04-05	6	3.3L	Main Conv., Due to O.E. design, #8 bushing or sizing with aftermarket pipe may be required	9224 ③	--
08-13	6	3.5L	Rear, Exc. Hybrid, Requires Welded Assembly 7505 to complete installation as OE is complete welded assembly	9419 ③	--
08-10	6	3.5L	Rear Manifold Conv.	1166 ③	--
08-09	6	3.5L	Manifold Unit, Front	1163 ③	--
<b>TOYOTA LAND CRUISER</b>					
91-92	6	4.0L	Right	4304 ③	2904③
91-92	6	4.0L	Left	4305 ③	2904③
88-90	6	4.0L	Left	--	2904③
88-90	6	4.0L	Right	--	2904③
81-87	6	4.2L		--	2905③
95-97	6	4.5L	Rear	9238 ③	2904③
95-97	6	4.5L	Front	9978 ③	2576③
93-94	6	4.5L	Left	4462 ③	2904③
93-94	6	4.5L	Right	4462 ③	2904③
98-02	8	4.7L	Left	9537 ③	--
98-02	8	4.7L	Right	9537 ③	--

③ Federal & California Emissions. Not For Sale or Use on vehicles licensed in the state of CA & NY (NY vehicles with CA Emissions). Check with your state authority for details.

**APPLICATION LISTINGS  
FEDERAL CONVERTERS**



YR/YRS	CYL	LITER	DESCRIPTION	DIRECT FIT	UNIVERSAL
<b>TOYOTA MATRIX</b>					
05-08	4	1.8L	Exc. XRS Models, Rear	--	2574R③○
05-08	4	1.8L	From 04/05, FWD, (Exc. XRS Models w/ 2ZZ-GE Eng.), Requires Resonator Pipe #58494 to Complete Installation.	4805 ③	--
05-08	4	1.8L	Exc. XRS Models, Front	--	2574R③○
03-06	4	1.8L	AWD, Complete Assembly Including Resonator Pipe	5049 ③	--
03-05	4	1.8L	To 04/05, FWD, (Exc. XRS Models w/ 2ZZ-GE Eng.), Requires Resonator Pipe # 68432 to Compare Installation	4805 ③	--
03-04	4	1.8L	FWD, (Exc. XRS Models w/2ZZ-GE Eng.), Complete Assembly Including Resonator Pipe	4274 ③	--
2003	4	1.8L	XRS, 6 Speed Standard Trans., Complete Assembly Including Resonator Pipe	5055 ③	--
11-13	4	2.4L	FWD, Rear, OE is a Welded Assembly, 68542 Pipe Required to Complete Installation	5124 ③	--
09-13	4	2.4L	Manifold Unit, Front	1297 ③	--
09-10	4	2.4L	S, FWD, Rear, OE is a Welded Assembly, 68542 Pipe Required to Complete Installation	5124 ③	--
<b>TOYOTA MR2</b>					
85-89	4	1.6L		4377 ③	6904③
91-95	4	2.0L		--	6904R③
91-95	4	2.2L		--	6904R③
<b>TOYOTA MR2 SPYDER</b>					
00-05	4	1.8L	Manifold Unit, Front	1299 ③	--
00-05	4	1.8L	Rear	5179 ③	--
<b>TOYOTA PASEO</b>					
96-99	4	1.5L	Manual Trans.	4891 ③	2539③
96-97	4	1.5L	Auto Trans.	--	2539③
92-95	4	1.5L		4377 ③	6904③
<b>TOYOTA PICKUP (ALL MODELS Exc. TACOMA &amp; TUNDRA)</b>					
93-95	4	2.4L	(Exc. Tacoma)	4087 ③	6906③
89-92	4	2.4L	4WD	4087 ③	6906③
89-92	4	2.4L	2WD	--	6905③
89-92	4	2.4L	4WD, California Emissions	4408 ⑤	6905⑤
84-88	4	2.4L		4408 ③	6905③
96-98	4	2.7L	T-100 Models	--	2504③
75-83	4	All	w/o Thermo Sensor Port	4377 ③	6904③
94-95	6	3.0L		4408 ③	6905③
93-94	6	3.0L	T-100 Models	--	2905③
88-93	6	3.0L	(Exc. T-100 Models)	4408 ③	6905③
96-98	6	3.4L	T-100 Models, 2WD, Ext. Cab, 1/2 Ton	9123 ③	--
96-98	6	3.4L	T-100 Models	--	2540③
<b>TOYOTA PREVIA VAN</b>					
94-97	4	2.4L	Front, Supercharged	4853 ③	2504③
94-95	4	2.4L	(Exc. Supercharged)	4550 ③	2504③
91-93	4	2.4L		4550 ③	6904③
<b>TOYOTA PRIUS</b>					
04-09	4	1.5L	Conv. includes Resonator	4642 ③	--
04-05	4	1.5L	Hybrid, Rear	--	2225③

- ③ Federal & California Emissions. Not For Sale or Use on vehicles licensed in the state of CA & NY (NY vehicles with CA Emissions). Check with your state authority for details.
- ⑤ California Emissions. Not For Sale or Use on vehicles licensed in the state of CA & NY. Check with your state authority.
- EPA Enhanced OBDII By Design Unit

YR/YRS	CYL	LITER	DESCRIPTION	DIRECT FIT	UNIVERSAL
<b>TOYOTA PRIUS (Cont.)</b>					
01-05	4	1.5L	Hybrid Front Conv.	--	2225③
01-03	4	1.5L	Front, OE is a welded assembly, cut prior to exhaust valves	4762 ③	--
10-15	4	1.8L	W/ Heat Exchanger, Rear	5194 ③	--
<b>TOYOTA PRIUS V</b>					
12-14	4	1.8L	W/ Heat Exchanger, Rear	5194 ③	--
<b>TOYOTA RAV4</b>					
01-03	4	2.0L	Complete Assembly	4293 ③	--
01-03	4	2.0L	Left	--	2574R③○
01-03	4	2.0L	Right	--	2574R③○
98-00	4	2.0L		4248 ③	2539③
96-97	4	2.0L	Front	1104 ③	--
96-97	4	2.0L		4204 ③	2505③
06-08	4	2.4L	Front	1107 ③	--
06-08	4	2.4L	Rear, Requires Welded Assembly 7454 to complete installation, OE is a complete welded assembly	4347 ③	2575R③○
06-08	4	2.4L	Rear, Complete Assembly Including Muffler	4986 ③	--
04-05	4	2.4L	Rear	5147 ③	--
09-13	4	2.5L	Rear, Requires Welded Assembly 7454 to complete installation, OE is a complete welded assembly	4347 ③	2575R③○
09-12	4	2.5L	Manifold Unit, Front	1306 ③	--
06-12	6	3.5L	Rear, Complete Assembly including Muffler, To 07/2011	4987 ③	--
06-12	6	3.5L	Manifold Unit, Front	1165 ③	--
06-12	6	3.5L	Rear Manifold Conv.	1168 ③	--
06-12	6	3.5L	Rear, Requires Welded Assembly P/N 40007 to complete installation. OE is a completely welded assembly.	4723 ③	--
06-12	6	3.5L		--	--
<b>TOYOTA SEQUOIA</b>					
01-04	8	4.7L	Right	9134 ③	2505R③
01-04	8	4.7L	Left	9135 ③	2505R③
<b>TOYOTA SIENNA</b>					
01-03	6	3.0L	Manifold Unit, Front	1076 ③	--
01-03	6	3.0L	Middle Conv.	9094 ③	--
01-03	6	3.0L	Rear	9095 ③	--
99-01	6	3.0L	California Emissions, Rear	5036 ⑤	--
98-00	6	3.0L	Federal Emissions	4590 ④	--
04-06	6	3.3L	AWD, Rear Converter, Requires 38938 Intermediate Pipe to Complete Installation	4694 ③	--
04-06	6	3.3L		--	--
04-06	6	3.3L	Manifold Unit, Front	1114 ③	--
04-06	6	3.3L	Rear Manifold Conv., FWD	1127 ③	--
04-06	6	3.3L	AWD, Rear Manifold Conv.	1119 ③	--
04-06	6	3.3L	FWD, Rear Converter, Requires 68460 Resonator Pipe to Complete Installation	4748 ③	--
04-06	6	3.3L		--	--
07-10	6	3.5L	AWD, Front Manifold Conv.	1165 ③	--
07-10	6	3.5L	FWD, Front Manifold Conv.	1163 ③	--
07-10	6	3.5L	FWD, Rear Manifold Conv.	1167 ③	--
07-10	6	3.5L	AWD, Rear Manifold Conv.	1166 ③	--

③ Federal & California Emissions. Not For Sale or Use on vehicles licensed in the state of CA & NY (NY vehicles with CA Emissions). Check with your state authority for details.

④ Federal Emissions. Not For Sale or Use on vehicles licensed in the state of CA. Check with your state authority.

⑤ California Emissions. Not For Sale or Use on vehicles licensed in the state of CA & NY. Check with your state authority.

○ EPA Enhanced OBDII By Design Unit

**APPLICATION LISTINGS  
FEDERAL CONVERTERS**



YR/YRS	CYL	LITER	DESCRIPTION	DIRECT FIT	UNIVERSAL
<b>TOYOTA SOLARA</b>					
2001	4	2.2L	Front	1061 ③	--
99-01	4	2.2L	Rear Main Conv.	4061 ③	2505R③
99-00	4	2.2L	California Emissions, Front	1061 ⑤	--
06-08	4	2.4L	From 05/2006, Front Manifold Conv.	1198 ③	--
02-08	4	2.4L	Rear Main	4320 ③	2565R③○
02-06	4	2.4L	To 05/2006, Front Manifold Conv.	1120 ③	--
99-03	6	3.0L	Rear, Auto Trans., Federal Emissions	4835 ④	2506R④
99-02	6	3.0L	Front Manifold Conv., California Emissions	1076 ⑤	--
99-02	6	3.0L	Rear Main, US Built, Auto Trans., California Emissions	4259 ⑤	--
04-08	6	3.3L	Manifold Unit, Front	1171 ③	--
04-08	6	3.3L	Rear Manifold Conv.	1173 ③	--
04-08	6	3.3L	Rear Main, USA Built, Auto Trans.	4383 ③	2574R③○
<b>TOYOTA STARLET</b>					
83-84	4	1.3L	w/o Thermo Sensor Port	4377 ③	6904③
83-84	4	1.3L	w/Airtube	--	6004③
81-82	4	1.3L		4377 ③	6904③
<b>TOYOTA SUPRA</b>					
85-86	6	2.8L		4377 ③	6904③
82-84	6	2.8L	w/o Thermo Sensor Port	4377 ③	6904③
1981	6	2.8L		4377 ③	6904③
1998	6	3.0L	Manifold Conv., (Exc. Turbo)	4276 ③	--
96-97	6	3.0L	Front	--	2513③
96-97	6	3.0L		--	2540③
93-95	6	3.0L	Rear, Turbo; From 5/93	--	6905③
93-94	6	3.0L	Front, (Exc. Turbo)	--	6904R③
93-94	6	3.0L	Rear, (Exc. Turbo)	--	6905③
87-93	6	3.0L	Front, Turbo; To 4/93	--	6904R③
87-93	6	3.0L	Rear, Turbo; To 4/93	4408 ③	6905③
86-92	6	3.0L	(Exc. Turbo)	4087 ③	6906③
<b>TOYOTA TACOMA</b>					
01-04	4	2.4L	Front	1040 ③	--
01-04	4	2.4L	Rear	9240 ③	2564R③
99-00	4	2.4L	Front, California Emissions	1040 ⑤	--
99-00	4	2.4L	Rear, California Emissions	9240 ⑤	2564R⑤○
95-98	4	2.4L		--	2540③
05-11	4	2.7L	To 09/11	9920 ③	--
01-04	4	2.7L	Rear	9240 ③	2564R③
01-04	4	2.7L	Front	4921 ③	--
2000	4	2.7L	Rear, California Emissions	9240 ⑤	2564R⑤○
2000	4	2.7L	Federal Emissions	9067 ④	2540④
2000	4	2.7L	California Emissions, Front	4921 ⑤	--
95-99	4	2.7L		9067 ③	2540③
01-04	6	3.4L	Front Conv.	4492 ③	2576R③○
01-04	6	3.4L	Rear Conv.	4693 ③	--
2000	6	3.4L	Federal Emissions	9067 ④	2540④
2000	6	3.4L	Front, California Emissions	4492 ⑤	2576R⑤○
2000	6	3.4L	Rear, California Emissions	4693 ⑤	--

- ③ Federal & California Emissions. Not For Sale or Use on vehicles licensed in the state of CA & NY (NY vehicles with CA Emissions). Check with your state authority for details.
- ④ Federal Emissions. Not For Sale or Use on vehicles licensed in the state of CA. Check with your state authority.
- ⑤ California Emissions. Not For Sale or Use on vehicles licensed in the state of CA & NY. Check with your state authority.
- EPA Enhanced OBDII By Design Unit

YR/YRS	CYL	LITER	DESCRIPTION	DIRECT FIT	UNIVERSAL
<b>TOYOTA TACOMA (Cont.)</b>					
95-99	6	3.4L		9067 ③	2540③
05-11	6	4.0L	Rear Right	9535 ③	--
05-11	6	4.0L	4WD, Rear Left	9534 ③	--
05-08	6	4.0L	Manifold Unit, Left	1149 ③	2575R③
05-08	6	4.0L	Right Manifold Conv.	1150 ③	2575R③
<b>TOYOTA TERCEL</b>					
95-97	4	1.5L	4 Speed Auto Trans.	4891 ③	2504R③
88-94	4	1.5L		4377 ③	6904③
83-88	4	All	w/Air Tube	--	6004③
86-87	4	All	(Canada Model)	--	6804③
80-86	4	All	w/o Thermo Sensor Port	4377 ③	6904③
<b>TOYOTA TUNDRA</b>					
01-04	6	3.4L	Front Conv.	4492 ③	2576R③○
01-04	6	3.4L	Rear	4493 ③	2505R③
2000	6	3.4L	Front, California Emissions	4492 ⑤	2576R⑤○
2000	6	3.4L	Rear, California Emission	4493 ⑤	2505R⑤
05-06	6	4.0L	Manifold Unit, Left	1149 ③	2575R③
05-06	6	4.0L	Right Manifold Conv.	1150 ③	2575R③
05-06	6	4.0L	Rear Right	9629 ③	--
07-09	8	4.7L	145.7" W.B., Left	5007 ③	--
07-09	8	4.7L	145.7" W.B., Front Left	--	2575③
07-09	8	4.7L	145.7" W.B., Rear Left	--	2545③
07-09	8	4.7L	Right	4691 ③	--
07-09	8	4.7L	Front Right	--	2575③
07-09	8	4.7L	Rear Right	--	2545③
05-06	8	4.7L	Right	9164 ③	2564R③○
05-06	8	4.7L	Left	9165 ③	2504R③
03-04	8	4.7L	Right	9977 ③	2564R③
03-04	8	4.7L	Left	9971 ③	2564R③
00-02	8	4.7L	Right	9058 ③	--
00-02	8	4.7L	Left	9059 ③	--
10-13	8	5.7L	145.7" W.B., Left	5054 ③	--
07-11	8	5.7L	Right	4636 ③	2575③○
07-09	8	5.7L	Left, Exc. Crew Max	4637 ③	2575③○
<b>TOYOTA VAN</b>					
88-89	4	2.2L		4087 ③	6906③
84-87	4	All		4377 ③	6904③
<b>TOYOTA VENZA</b>					
09-15	4	2.7L	Rear Converter, Requires Resonator Pipe #68526 to Complete Installation	5005 ③	--
09-15	6	3.5L	Rear Converter, Requires Resonator Pipe #68526 to Complete Installation	4743 ③	--
09-12	6	3.5L	To 05/2012, Front Manifold Conv.	1158 ③	--
09-12	6	3.5L	To 05/2012, Rear Manifold Conv.	1161 ③	--
<b>TOYOTA YARIS</b>					
2014	4	1.5L	Complete Assembly	5013 ③	--
2014	4	1.5L	Front	--	2574R③

③ Federal & California Emissions. Not For Sale or Use on vehicles licensed in the state of CA & NY (NY vehicles with CA Emissions). Check with your state authority for details.

⑤ California Emissions. Not For Sale or Use on vehicles licensed in the state of CA & NY. Check with your state authority.

○ EPA Enhanced OBDII By Design Unit

# APPLICATION LISTINGS

## FEDERAL CONVERTERS



YR/YRS	CYL	LITER	DESCRIPTION	DIRECT FIT	UNIVERSAL
<b>TOYOTA YARIS (Cont.)</b>					
2014	4	1.5L	Rear	--	2574R <sup>③</sup>
12-13	4	1.5L	Complete Assembly	5013 <sup>③</sup>	--
12-13	4	1.5L	Front	--	2574R <sup>③</sup>
12-13	4	1.5L	Rear	--	2574R <sup>③</sup>
06-11	4	1.5L	Hatchback	5009 <sup>③</sup>	--
<b>TRIUMPH TR7</b>					
77-79	4	2.0L		--	6904R <sup>③</sup>
80-81	4	All	w/51" Conv.	--	6904R <sup>③</sup>
<b>TRIUMPH TR8</b>					
80-81	8	3.5L	Left	--	6904R <sup>③</sup>
80-81	8	3.5L	Right	--	6904R <sup>③</sup>
<b>VOLKSWAGEN BEETLE</b>					
75-79	4	1.6L		--	6904R <sup>③</sup>
02-04	4	1.8L	Turbo	4369 <sup>③</sup>	--
99-01	4	1.8L	GLS Turbo	4369 <sup>③</sup>	--
98-04	4	1.9L		5188 <sup>③</sup>	--
03-05	4	2.0L		4371 <sup>③</sup>	--
01-02	4	2.0L	AVH Eng.	4371 <sup>③</sup>	--
2001	4	2.0L	AEG Eng.	9181 <sup>③</sup>	2540 <sup>③</sup>
98-00	4	2.0L	AEG Eng.	9181 <sup>③</sup>	2540 <sup>③</sup>
06-10	5	2.5L	With Single Oxygen Sensor in Assembly	5008 <sup>③</sup>	2573R <sup>③</sup>
<b>VOLKSWAGEN CABRIOLET</b>					
90-93	4	1.8L	w/34-1/2" Conv.	4032 ☆ <sup>③</sup>	2904 <sup>③</sup>
85-89	4	1.8L		--	6904R <sup>③</sup>
01-02	4	2.0L	GL, GLS, GLX, ABA Eng.	4114 <sup>③</sup>	2504R <sup>③</sup>
96-00	4	2.0L	ABA Eng.	4114 <sup>③</sup>	2504R <sup>③</sup>
1995	4	2.0L		--	2539 <sup>③</sup>
<b>VOLKSWAGEN CORRADO</b>					
90-92	4	1.8L	w/19-1/2" Conv & O2 Sensor Port in Conv. Body	--	2539 <sup>③</sup>
92-94	6	2.8L		--	6905R <sup>③</sup>
<b>VOLKSWAGEN Dasher</b>					
74-75	4	1.5L	From 8/74	--	6904R <sup>③</sup>
79-80	4	All	w/11-1/2" Conv.	--	6904R <sup>③</sup>
<b>VOLKSWAGEN EOS</b>					
07-08	4	2.0L		4912 <sup>③</sup>	--
<b>VOLKSWAGEN EUROVAN</b>					
93-95	4	2.5L		--	2905 <sup>③</sup>
97-00	6	2.8L	AES Eng.	9098 <sup>③</sup>	2515 <sup>③</sup>
<b>VOLKSWAGEN FOX</b>					
87-92	4	1.8L		--	6904R <sup>③</sup>
<b>VOLKSWAGEN GOLF</b>					
00-03	4	1.8L	GLS Turbo	4369 <sup>③</sup>	--
90-92	4	1.8L	8 valve, RV Eng., If 50mm O.D. Outlet Pipe Required Must Fabricate; From 1/90	--	6904R <sup>③</sup>
88-89	4	1.8L	RV Eng., If 50mm O.D. Outlet Pipe Required Must Fabricate	--	6904R <sup>③</sup>
87-89	4	1.8L	Golf GTI, PL Eng., 16 valve	--	6905R <sup>③</sup>
86-87	4	1.8L	w/2" Funnel Flange, w/2" OD Outlet, (Exc. RV or PL Eng.)	--	6904 <sup>③</sup>
86-87	4	1.8L	w/2" Funnel Flange, w/1-3/4" OD Outlet, (Exc. RV or PL Eng.)	--	6904 <sup>③</sup>

☆ Air Tube kit 4948 may be required for installation.

③ Federal & California Emissions. Not For Sale or Use on vehicles licensed in the state of CA & NY (NY vehicles with CA Emissions). Check with your state authority for details.

YR/YRS	CYL	LITER	DESCRIPTION	DIRECT FIT	UNIVERSAL
<b>VOLKSWAGEN GOLF (Cont.)</b>					
86-87	4	1.8L	w/2" Funnel Flange, w/1-7/8" OD Outlet, (Exc. RV or PL Eng.)	--	6904③
1985	4	1.8L	GTI, w/2" Funnel Flange, w/2" OD Outlet	--	6904③
1985	4	1.8L	GTI, w/2" Funnel Flange, w/1-3/4" OD Outlet	--	6904③
1985	4	1.8L	GTI, w/2" Funnel Flange, w/1-7/8" OD Outlet	--	6904③
99-04	4	1.9L		5188 ③	--
03-06	4	2.0L		4371 ③	--
01-02	4	2.0L	AVH Eng.	4371 ③	--
99-01	4	2.0L	AEG Eng.	9181 ③	2504R③
96-98	4	2.0L	GTI, ABA Eng., Manual Trans	4114 ③	2504R③
94-95	4	2.0L		--	6905R③
1993	4	2.0L		--	6904R③
90-92	4	2.0L	16 valve	--	6904R③
2010	5	2.5L		9536 ③	--
99-02	6	2.8L	AFP Eng.	4187 ③	--
96-98	6	2.8L	GTI VR6	9903 ③	2505R③
2004	6	3.2L	R32	5164 ③	--
<b>VOLKSWAGEN GTI</b>					
06-08	4	2.0L		4912 ③	--
<b>VOLKSWAGEN JETTA</b>					
00-03	4	1.8L	GLS Turbo	4369 ③	--
90-92	4	1.8L	RV Eng., If 50mm O.D. Outlet Pipe Required Must Fabricate	--	6904R③
90-92	4	1.8L	RV Eng. California Emissions	--	6904R⑤
88-92	4	1.8L	PF Eng.	--	6904R③
88-89	4	1.8L	RV Eng., If 50mm O.D. Outlet Pipe Required Must Fabricate	--	6904R③
87-89	4	1.8L	Jetta GLI, 16 valve, PL Eng.	--	6905R③
86-87	4	1.8L	RD Eng.	--	6904R③
86-87	4	1.8L	GX Eng., If 50mm O.D. Outlet Pipe Required Must Fabricate	--	6904R③
1985	4	1.8L	w/2" Funnel Flange, w/2" OD Outlet, (Exc. GLI)	--	6904③
1985	4	1.8L	w/2" Funnel Flange, w/1-3/4" OD Outlet, (Exc. GLI)	--	6904③
1985	4	1.8L	w/2" Funnel Flange, w/1-7/8" OD Outlet, (Exc. GLI)	--	6904③
99-04	4	1.9L		5188 ③	--
06-08	4	2.0L		4912 ③	--
04-05	4	2.0L	BBW Eng., California Emissions	5166 ⑤	--
02-05	4	2.0L	AVH & BEV Eng.	4371 ③	--
2001	4	2.0L		9181 ③	2504R③
99-00	4	2.0L	AEG Eng.	9181 ③	2504R③
96-98	4	2.0L	ABA Eng.	4114 ③	2504R③
1995	4	2.0L		--	2539③
1994	4	2.0L	19-1/2" Conv., If 50mm O.D. Outlet Pipe Required Must Fabricate	--	6904R③
90-93	4	2.0L		--	6904R③
80-84	4	All		--	6904R③
08-10	5	2.5L		9536 ③	--
05-07	5	2.5L	Eng. Code BGP	4447 ③	--
05-07	5	2.5L	BGQ Engine Designation	9536 ③	--
02-04	6	2.8L	BDF Eng., 6 Speed Manual Trans.	4484 ③	--
99-02	6	2.8L	AFP Eng.	4187 ③	--
96-97	6	2.8L		--	2505R③

③ Federal & California Emissions. Not For Sale or Use on vehicles licensed in the state of CA & NY (NY vehicles with CA Emissions). Check with your state authority for details.

⑤ California Emissions. Not For Sale or Use on vehicles licensed in the state of CA & NY. Check with your state authority.

**APPLICATION LISTINGS  
FEDERAL CONVERTERS**



YR/YRS	CYL	LITER	DESCRIPTION	DIRECT FIT	UNIVERSAL
<b>VOLKSWAGEN JETTA (Cont.)</b>					
94-95	6	2.8L		--	6905R <sup>③</sup>
<b>VOLKSWAGEN PASSAT</b>					
98-05	4	1.8L	Turbo	4186 <sup>③</sup>	--
2008	4	2.0L	BPY Engine only	4535 <sup>③①</sup>	--
			BPY Engine only	4929 <sup>③</sup>	--
06-07	4	2.0L		4535 <sup>③①</sup>	--
				4929 <sup>③</sup>	--
1996	4	2.0L	Sedan & Wagon, ABA Eng.	4114 <sup>③</sup>	2504R <sup>③</sup>
00-05	6	2.8L	Right, Auto Trans.	4240 <sup>③</sup>	--
00-05	6	2.8L	Left, Auto Trans.	4241 <sup>③</sup>	--
00-05	6	2.8L	Right, Manual Trans.	4660 <sup>③</sup>	--
00-05	6	2.8L	Left, Manual Trans.	4665 <sup>③</sup>	--
98-99	6	2.8L	Right, Auto Trans.	4374 <sup>③</sup>	--
98-99	6	2.8L	Left, Auto Trans.	4439 <sup>③</sup>	--
96-97	6	2.8L		9903 <sup>③</sup>	2505R <sup>③</sup>
93-95	6	2.8L		--	6905R <sup>③</sup>
06-08	6	3.6L		5037 <sup>③</sup>	--
<b>VOLKSWAGEN QUANTUM</b>					
82-88	4,5	All		--	6904R <sup>③</sup>
<b>VOLKSWAGEN R32</b>					
2008	6	3.2L		5060 <sup>③</sup>	--
<b>VOLKSWAGEN RABBIT</b>					
82-84	4	1.7L	Exc. Fuel Injection	--	6004 <sup>③</sup>
82-84	4	1.7L	Fuel Injection	--	6904R <sup>③</sup>
83-84	4	1.8L		--	6904R <sup>③</sup>
75-81	4	All		--	6904R <sup>③</sup>
08-09	5	2.5L		9536 <sup>③</sup>	--
2008	5	2.5L	Eng. Code CBTA, To Chassis #1K-8B000 006, 1K-8P002 061, 1K-8U000 007 & 1K-8W004 974	4447 <sup>③</sup>	--
				--	--
06-07	5	2.5L	Eng. Code BGP	4447 <sup>③</sup>	--
06-07	5	2.5L	BGQ Engine Designation	9536 <sup>③</sup>	--
<b>VOLKSWAGEN RABBIT PICKUP</b>					
80-83	4	All		--	6904R <sup>③</sup>
<b>VOLKSWAGEN ROUTAN</b>					
09-10	6	3.8L		4441 <sup>③</sup>	2576R <sup>③</sup>
<b>VOLKSWAGEN SCIROCCO</b>					
87-88	4	1.8L	16 valve, Complete; From 6/86	--	6905R <sup>③</sup>
86-88	4	1.8L	(Exc. 16 valve)	--	6904R <sup>③</sup>
84-85	4	1.8L	8 valve	--	6904R <sup>③</sup>
75-83	4	All		--	6904R <sup>③</sup>
<b>VOLKSWAGEN TOUAREG</b>					
04-06	6	3.2L	Front	1111 <sup>③</sup>	--
04-06	6	3.2L	Rear	4448 <sup>③</sup>	2576R <sup>③①</sup>
2007	6	3.6L	Left	5180 <sup>③</sup>	--
2007	6	3.6L	Right	5181 <sup>③</sup>	--
2007	6	3.6L	Rear	5182 <sup>③</sup>	--
04-07	8	4.2L	Front Left	5174 <sup>③</sup>	--
04-07	8	4.2L	Front Right	5175 <sup>③</sup>	--

① Discontinued, use until inventory is depleted.

③ Federal & California Emissions. Not For Sale or Use on vehicles licensed in the state of CA & NY (NY vehicles with CA Emissions). Check with your state authority for details.

○ EPA Enhanced OBDII By Design Unit



YR/YRS	CYL	LITER	DESCRIPTION	DIRECT FIT	UNIVERSAL
<b>VOLKSWAGEN TOUAREG (Cont.)</b>					
04-07	8	4.2L	Rear Left	5176 ③	--
04-07	8	4.2L	Rear Right	5177 ③	--
<b>VOLKSWAGEN VANAGON</b>					
83-85	4	1.9L		--	6904R③
80-83	4	2.0L		--	6904R③
86-91	4	2.1L		--	6904R③
77-79	4	All	w/12" Conv.	--	6904R③
77-79	4	All	w/11" Conv.	--	6804③
<b>VOLVO 240</b>					
1993	4	2.3L	w/EGR System	--	6904③
84-93	4	2.3L	w/o EGR System	4046 ③	6914③
82-83	4	All		--	6804③
82-83	4	All	Optional Direct Fit Converter	--	6804③
75-81	4	All		--	6804③
75-81	4	All	Optional Direct Fit Converter	--	6804③
<b>VOLVO 260</b>					
80-82	6	All	B28F Eng.	--	6804③
77-79	6	All	w/13" Conv.	--	6804③
77-79	6	All	w/13" Conv., Optional Direct Fit Converter	--	6804③
<b>VOLVO 262</b>					
78-79	6	2.7L	w/Chassis # 49070 - 262 Series	--	6804③
78-79	6	2.7L	w/Chassis # 49070 - 262 Series, Optional Direct Fit Conv.	--	6804③
<b>VOLVO 264</b>					
77-79	6	2.7L	w/Chassis # 66393 - 264 Series	--	6804③
77-79	6	2.7L	w/Chassis # 66393 - 264 Series, Optional Direct Fit Conv.	--	6804③
<b>VOLVO 265</b>					
77-79	6	2.7L	w/Chassis # 16957 - 265 Series	--	6804③
77-79	6	2.7L	w/Chassis # 16957 - 265 Series, Optional Direct Fit Conv.	--	6804③
<b>VOLVO 740</b>					
89-92	4	2.3L	SOHC, (Exc. Turbo)	4021 ③	6914③
85-92	4	2.3L	Turbo	4605 ③	6914③
89-91	4	2.3L	DOHC	4605 ③	6914③
85-88	4	2.3L	SOHC, (Exc. Turbo)	4021 ③	6914③
<b>VOLVO 760</b>					
84-90	4	2.3L	Turbo	4605 ③	6914③
87-90	6	2.8L		4605 ③	6914③
83-86	6	2.8L		--	6804③
<b>VOLVO 780</b>					
89-90	4	2.3L	Turbo	--	6914③
87-90	6	2.8L		4021 ③	6914③
<b>VOLVO 850</b>					
1996	5	2.3L	Sedan w/Turbo, Federal Emissions, w/out Spinning Inlet Flange	4189 ④	--
1996	5	2.3L	Sedan w/Turbo, Federal Emissions, w/Spinning Inlet Flange	4190 ④	--
94-95	5	2.3L	Sedan w/Turbo, w/out Spinning Inlet Flange	4189 ③	--
1997	5	2.4L	GLT Model	4470 ③	--
1995	5	2.4L	Auto Trans.	--	2905③
1995	5	2.4L	Manual Trans., Sedan & Station Wgn., w/2 Bolt Flange	4902 ☆③	2905③

☆ Air Tube kit 4948 may be required for installation.

③ Federal & California Emissions. Not For Sale or Use on vehicles licensed in the state of CA & NY (NY vehicles with CA Emissions). Check with your state authority for details.

④ Federal Emissions. Not For Sale or Use on vehicles licensed in the state of CA. Check with your state authority.

# APPLICATION LISTINGS

## FEDERAL CONVERTERS



YR/YRS	CYL	LITER	DESCRIPTION	DIRECT FIT	UNIVERSAL
<b>VOLVO 850 (Cont.)</b>					
93-94	5	2.4L	Sedan & Station Wgn., w/2 Bolt Flange	4902 ☆③	2905③
<b>VOLVO 940</b>					
91-95	4	2.3L	(Exc. Turbo)	4021 ③	6914③
91-95	4	2.3L	Turbo	4605 ③	6914③
<b>VOLVO 960</b>					
1996	6	2.9L		--	2513③
94-95	6	2.9L		--	2908③
92-93	6	2.9L		--	2908③
<b>VOLVO C30</b>					
07-10	5	2.4L	ULEV Emissions	5195 ③	--
<b>VOLVO S40/V40</b>					
00-04	4	1.9L	Front	1112 ③	--
00-04	4	1.9L		4312 ③	2540③
04-10	5	2.4L	S40, ULEV Emissions, w/ 2 Converters	5195 ③	--
04-07	5	2.4L	S40, With One Converter	4456 ③	2565R③
04-06	5	2.4L	S40, Manifold Unit, Front	1323 ③	--
<b>VOLVO S60</b>					
01-02	5	2.3L	Turbocharged	5157 ③	--
05-09	5	2.4L	Turbo	4557 ③	--
03-05	5	2.4L	Manifold Conv., B5244S Eng. Designation, (Exc. Turbo)	4486 ③	--
01-05	5	2.4L	Rear, Naturally Aspirated	4934 ③	--
01-02	5	2.4L	Manifold Conv., To Engine #2680829 (Exc. Turbo)	4486 ③	--
01-02	5	2.4L	Turbocharged	5157 ③	--
05-09	5	2.5L	Rear, Turbo, FWD, Exc. Model R	4557 ③	--
<b>VOLVO S70/V70</b>					
01-02	5	2.3L	V70, Turbocharged, FWD	5157 ③	--
2000	5	2.3L	V70, AWD Turbo, DF Front & Rear, Univ. Rear Only	4285 ③	2540③
03-07	5	2.4L	V70, Rear, Naturally Aspirated	4934 ③	--
2002	5	2.4L	V70, Manifold Conv., To Engine #2680829 (Exc. Turbo)	4486 ③	--
2001	5	2.4L	V70, Manifold Conv., (Exc. Turbo)	4486 ③	--
2001	5	2.4L	Turbo, AWD	4674 ③	--
2000	5	2.4L	S70, AWD Turbo, DF Front & Rear, Univ. Rear Only	4285 ③	2540③
2000	5	2.4L	V70, AWD Turbo, DF Front & Rear, Univ. Rear Only	4285 ③	2540③
2000	5	2.4L	V70, Naturally Aspirated	5189 ③	--
2000	5	2.4L	S70, Naturally Aspirated	5189 ③	--
98-99	5	2.4L	V70, AWD Turbo, 56-B5254T Engine	4576 ③	--
05-07	5	2.5L	V70, Rear, Turbo, Exc. Model R	4557 ③	--
<b>VOLVO S80</b>					
04-06	5	2.5L	Rear, Turbo	4557 ③	--
00-01	6	2.8L	Turbocharged, B6284T Engine Designation	5167 ③	--
02-05	6	2.9L	Turbocharged, B6294T Engine Designation	5145 ③	--
02-04	6	2.9L	Rear, Naturally Aspirated	5014 ③	--
02-04	6	2.9L	Naturally Aspirated, Manifold Unit, Front Right	1272 ③	--
02-04	6	2.9L	Naturally Aspirated, Manifold Unit, Front Left	1273 ③	--
99-01	6	2.9L	Naturally Aspirated, w/Precats, Center	5160 ③	--

☆ Air Tube kit 4948 may be required for installation.

③ Federal & California Emissions. Not For Sale or Use on vehicles licensed in the state of CA & NY (NY vehicles with CA Emissions). Check with your state authority for details.

YR/YRS	CYL	LITER	DESCRIPTION	DIRECT FIT	UNIVERSAL
<b>VOLVO V50</b>					
05-10	5	2.4L	ULEV Emissions, w/ 2 Converters	5195 ③	--
05-07	5	2.4L	With One Converter	4456 ③	2565R③○
05-06	5	2.4L	Manifold Unit, Front	1323 ③	--
<b>VOLVO XC90</b>					
07-10	6	3.2L	Manifold Unit, Right	1330 ③	--
07-10	6	3.2L	Manifold Unit, Left	1331 ③	--
07-10	6	3.2L	Center	5212 ③	--
05-11	8	4.4L	Center	5207 ③	--
<b>WORKHORSE W42</b>					
06-07	8	4.8L		9272 ③	--
<b>YUGO CABRIO</b>					
90-92	4	1.3L		--	6903③
<b>YUGO GV</b>					
86-89	4	1.1L		--	6903③
90-92	4	1.3L		--	6903③
<b>YUGO GVL</b>					
88-89	4	1.1L		--	6903③
<b>YUGO GVS</b>					
1988	4	1.1L		--	6903③
<b>YUGO GVX</b>					
88-89	4	1.3L		--	6903③

③ Federal & California Emissions. Not For Sale or Use on vehicles licensed in the state of CA & NY (NY vehicles with CA Emissions). Check with your state authority for details.

○ EPA Enhanced OBDII By Design Unit

# DIRECT FIT

## 1001

Inlet A: WELDED 5-BOLT FLANGE  
 Outlet A: WELDED 3-BOLT FLANGE  
 Length: 11.50"



1996-94 4 TOYOTA CAMRY, (Inc. 1998 & Older SOLARA) 2.2L

## 1009

Inlet A: WELDED 5-BOLT FLANGE W/ STUDS  
 Outlet A: WELDED 2.25" 3-BOLT FLANGE  
 Length: 18.88"



2002-01 4 KIA SPORTAGE 2.0L

## 1010

Inlet A: LOOSE 3-BOLT FLANGE W/ 2.25" FEMALE FLARE  
 Inlet B: LOOSE 3-BOLT FLANGE W/ 2.25" FEMALE FLARE  
 Outlet A: 3" O.D. PIPE  
 Length: 46.50"

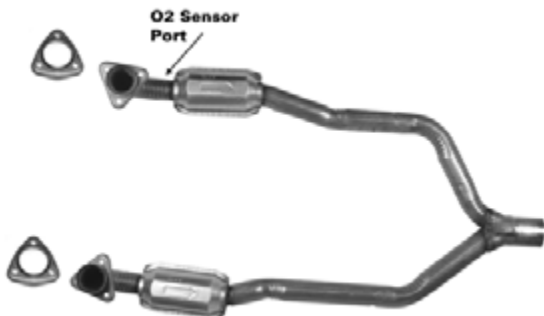

1991-86 8 CHEVROLET CORVETTE 5.7L

## 1011

Inlet A: WELDED 6-BOLT FLANGE  
 Outlet A: WELDED 2-BOLT FLANGE W/ STUDS  
 Length: 12.75"

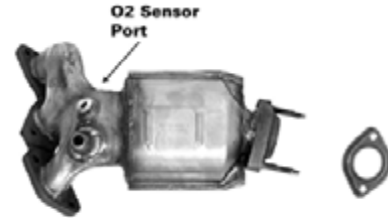

2000-95 6 FORD CONTOUR 2.5L  
 2000-99 6 MERCURY COUGAR 2.5L  
 2000-95 6 MERCURY MYSTIQUE 2.5L

## 1012

Inlet A: WELDED 6-BOLT FLANGE  
 Outlet A: WELDED 2-BOLT FLANGE  
 Length: 15"

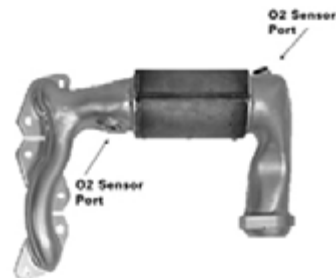

2000-95 6 FORD CONTOUR 2.5L  
 2000-99 6 MERCURY COUGAR 2.5L  
 2000-95 6 MERCURY MYSTIQUE 2.5L

## 1014

Inlet A: WELDED 5-BOLT FLANGE  
 Outlet A: WELDED 3-BOLT FLANGE  
 Length: 10.50"



2001-00 6 INFINITI I30 3.0L  
 2001-00 6 NISSAN MAXIMA 3.0L

### 1015

Inlet A: WELDED 6-BOLT FLANGE  
 Outlet A: WELDED 3-BOLT FLANGE  
 Length: 9.75"



- |         |   |                        |
|---------|---|------------------------|
| 2000-97 | 6 | INFINITI QX4 3.3L      |
| 2003-01 | 6 | INFINITI QX4 3.5L      |
| 2000-96 | 6 | NISSAN PATHFINDER 3.3L |
| 2004-01 | 6 | NISSAN PATHFINDER 3.5L |

### 1016

Inlet A: WELDED 6-BOLT FLANGE  
 Outlet A: WELDED 3-BOLT FLANGE  
 Length: 9.75"



- |         |   |                        |
|---------|---|------------------------|
| 2000-97 | 6 | INFINITI QX4 3.3L      |
| 2000-96 | 6 | NISSAN PATHFINDER 3.3L |

### 1017

Inlet A: WELDED 6-BOLT FLANGE  
 Outlet A: WELDED 3-BOLT FLANGE  
 Length: 10.75"



- |         |   |                    |
|---------|---|--------------------|
| 2001-98 | 4 | NISSAN ALTIMA 2.4L |
|---------|---|--------------------|

### 1018

Inlet A: WELDED 5-BOLT FLANGE  
 Outlet A: WELDED 3-BOLT FLANGE  
 Length: 7"



- |         |   |                       |
|---------|---|-----------------------|
| 2004-01 | 4 | HYUNDAI SANTA FE 2.4L |
| 2005-99 | 4 | HYUNDAI SONATA 2.4L   |

### 1018 (cont.)

- |         |   |                 |
|---------|---|-----------------|
| 2006-01 | 4 | KIA OPTIMA 2.4L |
|---------|---|-----------------|

### 1023

Inlet A: WELDED 5-BOLT FLANGE  
 Outlet A: WELDED 3-BOLT FLANGE  
 Length: 7.75"

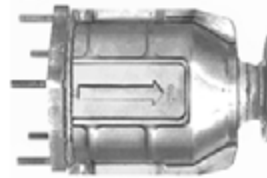

- |         |   |                    |
|---------|---|--------------------|
| 2000-99 | 4 | MAZDA PROTÉGÉ 1.8L |
| 2001-99 | 4 | MAZDA PROTÉGÉ 1.6L |
| 2003-01 | 4 | MAZDA PROTÉGÉ 2.0L |

### 1024

Inlet A: WELDED 7-BOLT FLANGE  
 Outlet A: WELDED 2-BOLT FLANGE  
 Length: 15.25"



- |         |   |                      |
|---------|---|----------------------|
| 2001-99 | 6 | HYUNDAI SONATA 2.5L  |
| 2005-02 | 6 | HYUNDAI SONATA 2.7L  |
| 2005-03 | 6 | HYUNDAI TIBURON 2.7L |
| 2001    | 6 | KIA OPTIMA 2.5L      |
| 2006-02 | 6 | KIA OPTIMA 2.7L      |

### 1025

Inlet A: WELDED 7-BOLT FLANGE  
 Outlet A: WELDED 2-BOLT FLANGE  
 Length: 15.25"



- |         |   |                     |
|---------|---|---------------------|
| 2001-99 | 6 | HYUNDAI SONATA 2.5L |
| 2005-02 | 6 | HYUNDAI SONATA 2.7L |
| 2001    | 6 | KIA OPTIMA 2.5L     |
| 2006-02 | 6 | KIA OPTIMA 2.7L     |

# DIRECT FIT

## 1026

Inlet A: WELDED 6-BOLT FLANGE  
Outlet A: WELDED 2-BOLT FLANGE  
Length: 15.25"

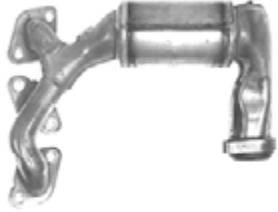

2001-00 6 MAZDA MPV VAN 2.5L

## 1027

Inlet A: WELDED 6-BOLT FLANGE  
Outlet A: WELDED 2-BOLT FLANGE  
Length: 13"

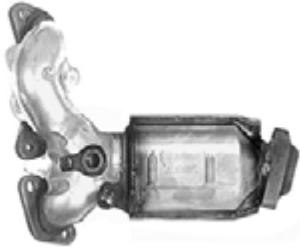

2001-00 6 MAZDA MPV VAN 2.5L

## 1030

Inlet A: WELDED 2-BOLT FLANGE W/ SPHERICAL FLARE  
Inlet B: WELDED 2-BOLT FLANGE W/ SPHERICAL FLARE  
Outlet A: WELDED 3-BOLT FLANGE  
Length: 27"



2003-00 6 JEEP WRANGLER 4.0L

## 1031

Inlet A: WELDED 2-BOLT FLANGE W/ SPHERICAL FLARE  
Inlet B: WELDED 2-BOLT FLANGE W/ SPHERICAL FLARE  
Outlet A: WELDED 3-BOLT FLANGE  
Length: 22"



2001-00 6 JEEP CHEROKEE 4.0L

## 1032

Inlet A: WELDED 2-BOLT FLANGE W/ GASKET STUB  
Outlet A: WELDED 2-BOLT FLANGE W/ GASKET STUB  
Length: 12.25"



2003-99 6 LEXUS RX300 3.0L  
2003-01 6 TOYOTA HIGHLANDER 3.0L

## 1033

Inlet A: WELDED 2-BOLT FLANGE  
Inlet B: WELDED 2-BOLT FLANGE  
Outlet A: WELDED 2-BOLT FLANGE W/ GASKET STUB  
Length: 21.50"



2003-99 6 LEXUS RX300 3.0L  
2003-01 6 TOYOTA HIGHLANDER 3.0L

## 1034

Inlet A: WELDED 5-BOLT FLANGE  
Outlet A: WELDED 3-BOLT FLANGE  
Length: 7.25"

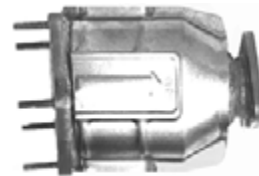

2002-00 4 MAZDA 626 2.0L

### 1035

Inlet A: WELDED 9-BOLT FLANGE W/ SPHERICAL FLARE  
 Outlet A: WELDED 2-BOLT FLANGE  
 Length: 19"

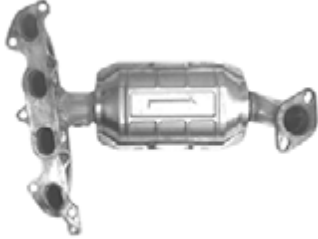

2005-03 4 KIA RIO 1.6L

### 1036

Inlet A: WELDED 3-BOLT FLANGE  
 Outlet A: WELDED 3-BOLT FLANGE  
 Length: 13.75"



2001-99 6 NISSAN FRONTIER 3.3L  
 2001-00 6 NISSAN XTERRA 3.3L

### 1037

Inlet A: WELDED 3-BOLT FLANGE  
 Outlet A: WELDED 3-BOLT FLANGE  
 Length: 12.75"



2001-99 6 NISSAN FRONTIER 3.3L  
 2001-00 6 NISSAN XTERRA 3.3L

### 1038

Inlet A: WELDED 5-BOLT FLANGE  
 Outlet A: WELDED 3-BOLT FLANGE  
 Length: 6.38"

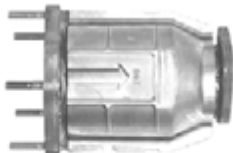

2002-98 4 KIA SPORTAGE 2.0L

### 1039

Inlet A: WELDED 2-BOLT FLANGE W/ SPHERICAL FLARE  
 Inlet B: WELDED 2-BOLT FLANGE W/ SPHERICAL FLARE  
 Outlet A: 2.50" O.D. PIPE  
 Length: 41"



2004-01 6 JEEP GRAND CHEROKEE/GRAND WAGONEER 4.0L

### 1040

Inlet A: WELDED 3-BOLT FLANGE W/ GASKET STUB  
 Outlet A: WELDED 2-BOLT FLANGE W/ GASKET STUB  
 Length: 25"

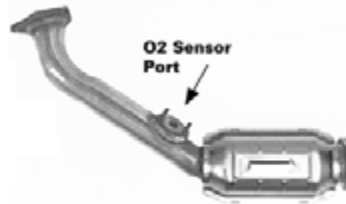

2004-99 4 TOYOTA TACOMA 2.4L

### 1041

Inlet A: WELDED 6-BOLT FLANGE  
 Outlet A: WELDED 3-BOLT FLANGE  
 Length: 7.63"



1997-95 4 NISSAN ALTIMA 2.4L

# DIRECT FIT

## 1042

Inlet A: WELDED 9-BOLT FLANGE  
 Outlet A: WELDED 2-BOLT FLANGE W/ GASKET STUB  
 Length: 17.50"



- 2001-98 4 CHEVROLET METRO 1.3L
- 1997 4 GEO METRO 1.3L
- 2001-98 4 SUZUKI SWIFT 1.3L

## 1043

Inlet A: WELDED 6-BOLT FLANGE  
 Outlet A: WELDED 3-BOLT FLANGE  
 Length: 8.50"



- 2006-03 4 NISSAN SENTRA 1.8L

## 1044

Inlet A: LOOSE 2-BOLT FLANGE W/ SPHERICAL FLARE  
 Inlet B: LOOSE 2-BOLT FLANGE W/ SPHERICAL FLARE  
 Outlet A: WELDED 3-BOLT FLANGE  
 Length: 21.50"



- 2002-98 6 FORD EXPLORER 4.0L
- 2003-01 6 FORD RANGER 4.0L
- 2003-01 6 MAZDA B-Series PICKUP 4.0L
- 2001-98 6 MERCURY MOUNTAINEER 4.0L

## 1046

Inlet A: LOOSE 2 BOLT FLANGE, W/ FEMALE FLARE  
 Outlet A: 1.88" O.D. PIPE  
 Length: 37.50"



- 1997-93 6 CHRYSLER CONCORDE 3.5L
- 1997-94 6 CHRYSLER LHS 3.5L
- 1996-94 6 CHRYSLER NEW YORKER 3.5L
- 1997-93 6 DODGE INTREPID 3.5L
- 1996-93 6 EAGLE VISION 3.5L

## 1047

Inlet A: LOOSE 2 BOLT FLANGE, W/ FEMALE FLARE  
 Outlet A: 1.88" O.D. PIPE  
 Length: 34.25"



- 1997-93 6 CHRYSLER CONCORDE 3.5L
- 1997-94 6 CHRYSLER LHS 3.5L
- 1996-94 6 CHRYSLER NEW YORKER 3.5L
- 1997-93 6 DODGE INTREPID 3.5L
- 1996-93 6 EAGLE VISION 3.5L

## 1048

Inlet A: 45 DEGREE FLARE  
 Outlet A: WELDED 2-BOLT FLANGE  
 Length: 14.25"



- 2003-02 6 JEEP LIBERTY 3.7L



### 1049

Inlet A: 45 DEGREE FLARE  
 Outlet A: WELDED 2-BOLT FLANGE W/ GASKET STUB  
 Length: 13.50"



2003-02 6 JEEP LIBERTY 3.7L

### 1050

Inlet A: WELDED 5-BOLT FLANGE  
 Outlet A: WELDED 2-BOLT FLANGE  
 Length: 35"



1999-98 4 MAZDA 626 2.0L

### 1051

Inlet A: WELDED 7-BOLT FLANGE  
 Outlet A: WELDED 2-BOLT FLANGE  
 Length: 15.25"



2005-03 6 HYUNDAI TIBURON 2.7L

### 1052

Inlet A: WELDED 3-BOLT FLANGE  
 Outlet A: WELDED 3-BOLT FLANGE  
 Length: 7"



2002-99 4 DAEWOO LEGANZA 2.2L

### 1053

Inlet A: WELDED 3-BOLT FLANGE W/ GASKET STUB  
 Outlet A: WELDED 2-BOLT FLANGE W/ GASKET STUB  
 Length: 20"

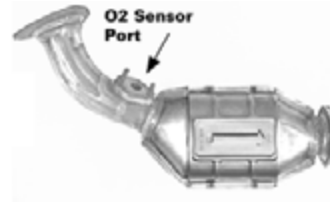

2002-99 6 TOYOTA 4 RUNNER 3.4L

### 1054

Inlet A: WELDED 3-BOLT FLANGE W/ STUDS  
 Outlet A: WELDED 3-BOLT FLANGE W/ STUDS  
 Length: 7"



2002-99 4 DAEWOO NUBIRA 2.0L

### 1055

Inlet A: WELDED 7-BOLT FLANGE  
 Outlet A: WELDED 3-BOLT FLANGE  
 Length: 15.50"



2002-95 6 MAZDA MILLENIA 2.3L

### 1056

Inlet A: WELDED 7-BOLT FLANGE  
 Outlet A: WELDED 3-BOLT FLANGE  
 Length: 11.50"

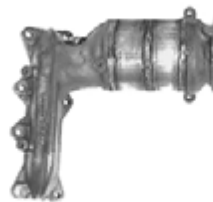

2002-95 6 MAZDA MILLENIA 2.3L

# DIRECT FIT

## 1061

Inlet A: WELDED 6-BOLT FLANGE  
 Outlet A: WELDED 3-BOLT FLANGE  
 Length: 17.38"



- 2001-97 4 TOYOTA CAMRY, (Inc. 1998 & Older SOLARA) 2.2L
- 2001-99 4 TOYOTA SOLARA 2.2L

## 1062

Inlet A: WELDED 9-BOLT FLANGE  
 Outlet A: WELDED 2-BOLT FLANGE  
 Length: 20.25"



- 2005-01 4 HYUNDAI ELANTRA 2.0L
- 2006-03 4 HYUNDAI TIBURON 2.0L

## 1064

Inlet A: WELDED 2-BOLT FLANGE W/ GASKET STUB  
 Inlet B: W/ RING GASKET  
 Outlet A: WELDED 2-BOLT FLANGE W/ GASKET STUB  
 Length: 23.75"



- 2003-01 6 MITSUBISHI MONTERO SPORT 3.0L

## 1065

Inlet A: WELDED 2-BOLT FLANGE W/ GASKET STUB  
 Outlet A: LOOSE 2-BOLT FLANGE W/ SPHERICAL FLARE  
 Length: 26.50"



- 2003-01 6 MITSUBISHI MONTERO SPORT 3.0L

## 1067

Inlet A: WELDED 5-BOLT FLANGE  
 Outlet A: WELDED 3-BOLT FLANGE  
 Length: 8.63"



- 1991-87 4 TOYOTA CAMRY, (Inc. 1998 & Older SOLARA) 2.0L
- 1993-90 4 TOYOTA CELICA 2.2L

## 1069

Inlet A: WELDED 3-BOLT FLANGE  
 Outlet A: WELDED 3-BOLT FLANGE  
 Length: 35"



- 2005-00 6 SATURN L300 3.0L
- 2005-00 6 SATURN LW300 3.0L

## 1070

Inlet A: WELDED 5-BOLT FLANGE  
 Outlet A: WELDED 2-BOLT FLANGE  
 Length: 6"

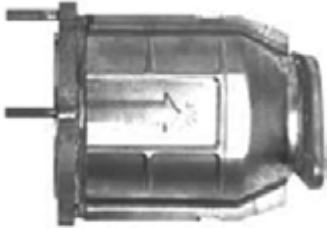

- 2001 6 HYUNDAI XG300 3.0L
- 2003-02 6 HYUNDAI XG350 3.5L
- 2005-02 6 KIA SEDONA 3.5L

## 1071

Inlet A: WELDED 2-BOLT FLANGE  
 Outlet A: WELDED 2-BOLT FLANGE  
 Length: 37.25"



- 1995-92 6 MAZDA 929 3.0L

## 1072

Inlet A: WELDED 2-BOLT FLANGE  
 Outlet A: WELDED 2-BOLT FLANGE  
 Length: 38.75"



- 1995-92 6 MAZDA 929 3.0L

## 1074

Inlet A: WELDED 3-BOLT FLANGE W/ GASKET STUB  
 Outlet A: WELDED 2-BOLT FLANGE W/ GASKET STUB  
 Length: 16"



- 2002-99 4 CHEVROLET TRACKER 1.6L
- 2004-99 4 CHEVROLET TRACKER 2.0L
- 2001-99 4 SUZUKI VITARA, GRAND VITARA 1.6L
- 2003-99 4 SUZUKI VITARA, GRAND VITARA 2.0L

## 1075

Inlet A: WELDED 4-BOLT FLANGE  
 Outlet A: WELDED 4-BOLT FLANGE  
 Length: 13.25"



- 1995-94 6 HONDA PASSPORT 3.2L
- 1995-93 6 ISUZU RODEO 3.2L

## 1076

Inlet A: WELDED 6-BOLT FLANGE  
 Outlet A: WELDED 2-BOLT FLANGE  
 Length: 14"



- 2001-96 6 LEXUS ES300 3.0L
- 2004-96 6 TOYOTA AVALON 3.0L
- 2001-96 6 TOYOTA CAMRY, (Inc. 1998 & Older SOLARA) 3.0L
- 2003-01 6 TOYOTA SIENNA 3.0L
- 2002-99 6 TOYOTA SOLARA 3.0L

# DIRECT FIT

## 1077

Inlet A: WELDED 5-BOLT FLANGE W/ STUDS  
 Outlet A: WELDED 2-BOLT FLANGE W/ GASKET STUB  
 Length: 17.50"



2000-98 4 KIA SPORTAGE 2.0L

## 1078

Inlet A: WELDED 6-BOLT FLANGE  
 Outlet A: WELDED 3-BOLT FLANGE  
 Length: 10.50"



2004-02 6 INFiniti I35 3.5L  
 2003-02 6 NISSAN MAXIMA 3.5L

## 1079

Inlet A: WELDED 4-BOLT FLANGE  
 Outlet A: WELDED 3-BOLT FLANGE  
 Length: 8.25"

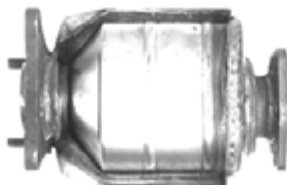

2004-02 6 INFiniti I35 3.5L  
 2003-02 6 NISSAN MAXIMA 3.5L

## 1080

Inlet A: WELDED 6-BOLT FLANGE  
 Outlet A: WELDED 3-BOLT FLANGE  
 Length: 16"

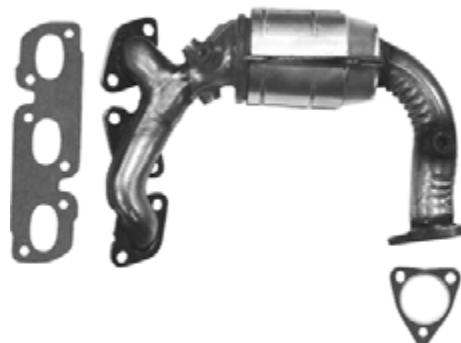

2006-02 6 MAZDA MPV VAN 3.0L

## 1081

Inlet A: WELDED 6-BOLT FLANGE  
 Outlet A: WELDED 3-BOLT FLANGE  
 Length: 13"



2006-02 6 MAZDA MPV VAN 3.0L

## 1082

Inlet A: WELDED 9-BOLT FLANGE  
 Outlet A: WELDED 2-BOLT FLANGE  
 Length: 17"



2005-01 4 CHRYSLER SEBRING 2.4L  
 2005-01 4 DODGE STRATUS 2.4L  
 2005-00 4 MITSUBISHI ECLIPSE 2.4L

### 1082 (cont.)

2003-00 4 MITSUBISHI GALANT 2.4L

### 1083

Inlet A: WELDED 5-BOLT FLANGE W/ STUDS  
 Outlet A: WELDED 2-BOLT FLANGE W/ GASKET STUB  
 Length: 14.50"



1999-98 4 KIA SEPHIA 1.8L

### 1084

Inlet A: LOOSE 2-BOLT FLANGE W/ SPHERICAL FLARE  
 Inlet B: WELDED 2-BOLT FLANGE  
 Outlet A: WELDED 2-BOLT FLANGE  
 Length: 29"



2005-00 6 FORD TAURUS 3.0L  
 2005-00 6 MERCURY SABLE 3.0L

### 1085

Inlet A: WELDED 6-BOLT FLANGE  
 Outlet A: WELDED 2-BOLT FLANGE  
 Length: 14.25"



2005-00 6 FORD TAURUS 3.0L  
 2005-00 6 MERCURY SABLE 3.0L

### 1086

Inlet A: WELDED 9-BOLT FLANGE  
 Outlet A: WELDED 2-BOLT FLANGE  
 Length: 14.25"



2007-02 4 MITSUBISHI LANCER 2.0L

### 1088

Inlet A: WELDED 5-BOLT FLANGE W/ STUDS  
 Outlet A: WELDED 2-BOLT FLANGE W/ GASKET STUB  
 Length: 12.75"



1998-95 4 MAZDA PROTÉGÉ 1.5L

### 1089

Inlet A: WELDED 5-BOLT FLANGE  
 Outlet A: WELDED 2-BOLT FLANGE  
 Length: 6.25"



2001 6 HYUNDAI XG300 3.0L  
 2003-02 6 HYUNDAI XG350 3.5L  
 2005-02 6 KIA SEDONA 3.5L

# DIRECT FIT

## 1090

Inlet A: WELDED 3-BOLT FLANGE W/ STUDS  
 Outlet A: LOOSE 2-BOLT FLANGE W/ MALE BALL  
 Length: 21.25"



- 1996-93 6 CHRYSLER CONCORDE 3.3L
- 1996-93 6 DODGE INTREPID 3.3L
- 1996-93 6 EAGLE VISION 3.3L

## 1091

Inlet A: WELDED 3-BOLT FLANGE W/ STUDS  
 Outlet A: LOOSE 2-BOLT FLANGE W/ MALE BALL  
 Length: 24"



- 1996-93 6 CHRYSLER CONCORDE 3.3L
- 1996-93 6 DODGE INTREPID 3.3L
- 1996-93 6 EAGLE VISION 3.3L

## 1092

Inlet A: LOOSE 2-BOLT FLANGE W/ FEMALE FLARE  
 Outlet A: 1.88" O.D. PIPE  
 Length: 40"



- 1996-93 6 CHRYSLER CONCORDE 3.3L
- 1997-93 6 DODGE INTREPID 3.3L
- 1997-93 6 EAGLE VISION 3.3L

## 1093

Inlet A: LOOSE 2-BOLT FLANGE W/ FEMALE FLARE  
 Outlet A: 1.88" O.D. PIPE  
 Length: 37.25"



- 1996-93 6 CHRYSLER CONCORDE 3.3L
- 1997-93 6 DODGE INTREPID 3.3L
- 1997-93 6 EAGLE VISION 3.3L

## 1094

Inlet A: WELDED 3-BOLT FLANGE  
 Outlet A: WELDED 2-BOLT FLANGE  
 Length: 8.63"



- 2005-01 6 CHRYSLER SEBRING 3.0L
- 2005-01 6 DODGE STRATUS 3.0L
- 2002-99 6 MITSUBISHI DIAMANTE 3.5L
- 2005-00 6 MITSUBISHI ECLIPSE 3.0L
- 2003-99 6 MITSUBISHI GALANT 3.0L

## 1095

Inlet A: WELDED 3-BOLT FLANGE  
 Outlet A: WELDED 2-BOLT FLANGE  
 Length: 13.75"



- 2005-01 6 CHRYSLER SEBRING 3.0L
- 2005-01 6 DODGE STRATUS 3.0L
- 2002-99 6 MITSUBISHI DIAMANTE 3.5L
- 2005-00 6 MITSUBISHI ECLIPSE 3.0L
- 2003-99 6 MITSUBISHI GALANT 3.0L

## 1096

Inlet A: WELDED 2-BOLT FLANGE  
 Outlet A: WELDED 2-BOLT FLANGE  
 Length: 14.50"



- 1999 4 MITSUBISHI ECLIPSE 2.4L
- 2000-99 4 MITSUBISHI GALANT 2.4L

### 1097

Inlet A: LOOSE 2-BOLT FLANGE W/ SPHERICAL FLARE  
 Inlet B: LOOSE 2-BOLT FLANGE W/ SPHERICAL FLARE  
 Outlet A: 2.50" O.D. PIPE  
 Length: 34.63"



2001-99 8 JEEP GRAND CHEROKEE/GRAND WAGONEER 4.7L

### 1098

Inlet A: WELDED 7-BOLT FLANGE  
 Outlet A: WELDED 2-BOLT FLANGE  
 Length: 15.75"



2007-06 4 HYUNDAI SONATA 2.4L  
 2008-06 4 KIA OPTIMA 2.4L

### 1102

Inlet A: WELDED 7-BOLT FLANGE  
 Outlet A: WELDED 2-BOLT FLANGE  
 Length: 17"



2004 6 MITSUBISHI ENDEAVOR 3.8L

### 1103

Inlet A: WELDED 7-BOLT FLANGE  
 Inlet B: WELDED 2-BOLT FLANGE  
 Outlet A: WELDED 2-BOLT FLANGE W/ GASKET STUB  
 Length: 21.25"



2004 6 MITSUBISHI ENDEAVOR 3.8L

### 1104

Inlet A: WELDED 5-BOLT FLANGE  
 Outlet A: WELDED 3-BOLT FLANGE  
 Length: 8.63"



1997-96 4 TOYOTA RAV4 2.0L

### 1105

Inlet A: LOOSE 2-BOLT FLANGE W/ SPHERICAL FLARE  
 Inlet B: LOOSE 2-BOLT FLANGE W/ SPHERICAL FLARE  
 Outlet A: WELDED 3-BOLT FLANGE  
 Length: 33.50"



2006-04 6 FORD RANGER 3.0L  
 2006-04 6 MAZDA B-Series PICKUP 3.0L

# DIRECT FIT

## 1106

Inlet A: WELDED 2-BOLT FLANGE  
 Inlet B: WELDED 2-BOLT FLANGE  
 Outlet A: WELDED 2-BOLT FLANGE W/ GASKET STUB  
 Length: 21"



2002-01 6 MITSUBISHI MONTERO 3.5L

## 1107

Inlet A: WELDED 5-BOLT FLANGE  
 Outlet A: WELDED 2-BOLT FLANGE W/ GASKET STUB  
 Length: 19.13"



2012-08 4 SCION XB 2.4L  
 2008-06 4 TOYOTA RAV4 2.4L

## 1108

Inlet A: WELDED 9-BOLT FLANGE  
 Outlet A: WELDED 2-BOLT FLANGE  
 Length: 16.25"



2009-04 4 KIA SPECTRA 2.0L

## 1109

Inlet A: WELDED 5-BOLT FLANGE  
 Outlet A: WELDED 3-BOLT FLANGE  
 Length: 11.63"



2004-01 4 NISSAN FRONTIER 2.4L  
 2004-01 4 NISSAN XTERRA 2.4L

## 1110

Inlet A: WELDED 10-BOLT FLANGE  
 Outlet A: WELDED 2-BOLT FLANGE W/ GASKET STUB  
 Length: 19"

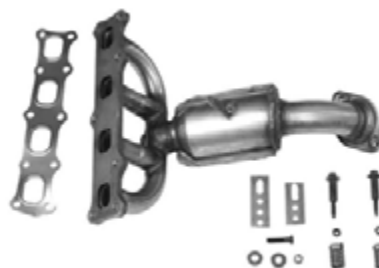

2008-07 4 DODGE CALIBER 2.4L  
 2008-07 4 JEEP COMPASS 2.0L  
 2010-07 4 JEEP COMPASS 2.4L  
 2008-07 4 JEEP PATRIOT 2.0L  
 2008-07 4 JEEP PATRIOT 2.4L

## 1111

Inlet A: WELDED 3-BOLT FLANGE  
 Inlet B: WELDED 3-BOLT FLANGE  
 Outlet A: WELDED 3-BOLT FLANGE  
 Length: 32"



2006-04 6 VOLKSWAGEN TOUAREG 3.2L



### 1112

Inlet A: WELDED 3-BOLT FLANGE  
 Outlet A: WELDED 4-BOLT FLANGE  
 Length: 13.25"



2004-00 4 VOLVO S40/V40 1.9L

### 1113

Inlet A: WELDED 3-BOLT FLANGE  
 Outlet A: WELDED 2-BOLT FLANGE W/ GASKET STUB  
 Length: 13.50"



2001-00 3 HONDA INSIGHT 1.0L

### 1114

Inlet A: WELDED 6-BOLT FLANGE  
 Outlet A: WELDED 2-BOLT FLANGE  
 Length: 17"



2006-04 6 LEXUS RX330 3.3L  
 2007-04 6 TOYOTA HIGHLANDER 3.3L  
 2006-04 6 TOYOTA SIENNA 3.3L

### 1115

Inlet A: WELDED 3-BOLT FLANGE  
 Outlet A: WELDED 2-BOLT FLANGE W/ GASKET STUB  
 Length: 22.25"



2001-95 4 SUZUKI ESTEEM 1.6L

### 1116

Inlet A: WELDED 9-BOLT FLANGE  
 Outlet A: WELDED 3-BOLT FLANGE  
 Length: 11.50"



2002-99 4 SATURN SC2 1.9L  
 2002-99 4 SATURN SL2 1.9L  
 2001-99 4 SATURN SW2 1.9L

### 1117

Inlet A: WELDED 2-BOLT FLANGE W/ GASKET STUB  
 Outlet A: WELDED 2-BOLT FLANGE  
 Length: 13.75"



2002-97 4 MITSUBISHI MIRAGE 1.5L

# DIRECT FIT

## 1118

Inlet A: WELDED 6-BOLT FLANGE  
 Outlet A: WELDED 3-BOLT FLANGE  
 Length: 9.50"



- 2003-01 6 INFINITI QX4 3.5L
- 2004-01 6 NISSAN PATHFINDER 3.5L

## 1119

Inlet A: WELDED 6-BOLT FLANGE  
 Outlet A: WELDED 2-BOLT FLANGE  
 Length: 16.50"



- 2006-04 6 LEXUS RX330 3.3L
- 2007-04 6 TOYOTA HIGHLANDER 3.3L
- 2006-04 6 TOYOTA SIENNA 3.3L

## 1120

Inlet A: WELDED 5-BOLT FLANGE  
 Outlet A: WELDED 2-BOLT FLANGE  
 Length: 18.88"



- 2006-02 4 TOYOTA CAMRY, (Inc. 1998 & Older SOLARA) 2.4L
- 2006-02 4 TOYOTA SOLARA 2.4L

## 1121

Inlet A: WELDED 7-BOLT FLANGE  
 Outlet A: WELDED 2-BOLT FLANGE  
 Length: 21.75"



- 2007-05 4 FORD FOCUS 2.0L
- 2007-05 4 FORD FOCUS 2.3L

## 1122

Inlet A: WELDED 6-BOLT FLANGE  
 Outlet A: WELDED 2-BOLT FLANGE W/ GASKET STUB  
 Length: 22.50"



- 2012-06 6 FORD FUSION 3.0L
- 2006 6 LINCOLN ZEPHYR 3.0L
- 2011-06 6 MERCURY MILAN 3.0L

## 1123

Inlet A: WELDED 6-BOLT FLANGE  
 Outlet A: WELDED 2-BOLT FLANGE  
 Length: 17"



- 2008-06 6 FORD FUSION 3.0L
- 2006 6 LINCOLN ZEPHYR 3.0L
- 2008-06 6 MERCURY MILAN 3.0L

**1124**

Inlet A: WELDED 6-BOLT FLANGE  
 Outlet A: WELDED 3-BOLT FLANGE  
 Length: 18.50"



2004-02 6 NISSAN FRONTIER 3.3L  
 2004-02 6 NISSAN XTERRA 3.3L

**1127**

Inlet A: WELDED 6-BOLT FLANGE  
 Outlet A: WELDED 2-BOLT FLANGE  
 Length: 17"



2006-04 6 TOYOTA SIENNA 3.3L

**1125**

Inlet A: WELDED 6-BOLT FLANGE  
 Outlet A: WELDED 3-BOLT FLANGE  
 Length: 20.50"



2004-02 6 NISSAN FRONTIER 3.3L  
 2004-02 6 NISSAN XTERRA 3.3L

**1128**

Inlet A: WELDED 7-BOLT FLANGE  
 Outlet A: WELDED 2-BOLT FLANGE  
 Length: 13.50"



2009-05 6 HYUNDAI TUCSON 2.7L

**1126**

Inlet A: WELDED 6-BOLT FLANGE  
 Outlet A: WELDED 3-BOLT FLANGE  
 Length: 10.25"



2006-04 6 NISSAN ALTIMA 3.5L

**1129**

Inlet A: WELDED 7-BOLT FLANGE  
 Outlet A: WELDED 2-BOLT FLANGE  
 Length: 14.50"



2009-05 6 HYUNDAI TUCSON 2.7L

# DIRECT FIT

## 1130

Inlet A: LOOSE 2-BOLT FLANGE W/ SPHERICAL FLARE  
 Inlet B: LOOSE 2-BOLT FLANGE W/ SPHERICAL FLARE  
 Outlet A: WELDED 3-BOLT FLANGE  
 Length: 48"



2004-02 8 FORD E-150 VAN 1/2 TON 5.4L  
 2004-02 8 FORD E-250 VAN 3/4 TON 5.4L

## 1131

Inlet A: WELDED 12-BOLT FLANGE  
 Outlet A: WELDED 2-BOLT FLANGE  
 Length: 28.50"



2002 8 INFINITI Q45 4.5L

## 1134

Inlet A: WELDED 9-BOLT FLANGE  
 Outlet A: WELDED 3-BOLT FLANGE  
 Length: 21"



2004-01 6 CHEVROLET TRACKER 2.5L  
 2005-99 6 SUZUKI VITARA, GRAND VITARA 2.5L

## 1135

Inlet A: WELDED 9-BOLT FLANGE  
 Outlet A: WELDED 3-BOLT FLANGE  
 Length: 21"



2004-01 6 CHEVROLET TRACKER 2.5L  
 2005-99 6 SUZUKI VITARA, GRAND VITARA 2.5L

## 1136

Inlet A: WELDED 7-BOLT FLANGE  
 Outlet A: WELDED 3-BOLT FLANGE  
 Length: 22"



2008-06 4 FORD ESCAPE 2.3L  
 2008-06 4 MAZDA TRIBUTE 2.3L  
 2008-06 4 MERCURY MARINER 2.3L

## 1137

Inlet A: WELDED 4-BOLT FLANGE  
 Outlet A: WELDED 3-BOLT FLANGE  
 Length: 14"



2007-03 6 NISSAN MURANO 3.5L

### 1138

Inlet A: WELDED 7-BOLT FLANGE  
 Outlet A: WELDED 2-BOLT FLANGE  
 Length: 22"



2007-04 4 FORD FOCUS 2.3L  
 2008-05 4 FORD FOCUS 2.0L

### 1139

Inlet A: WELDED 8-BOLT FLANGE  
 Outlet A: WELDED 3-BOLT FLANGE  
 Length: 12"



2002-01 4 SATURN SC1 1.9L  
 2002-01 4 SATURN SL / SL1 1.9L

### 1140

Inlet A: WELDED 5-BOLT FLANGE  
 Outlet A: WELDED 2-BOLT FLANGE  
 Length: 7.50"



2006-03 6 HYUNDAI SANTA FE 3.5L

### 1141

Inlet A: WELDED 5-BOLT FLANGE  
 Outlet A: WELDED 2-BOLT FLANGE  
 Length: 9"



2006-03 6 HYUNDAI SANTA FE 3.5L

### 1142

Inlet A: WELDED 7-BOLT FLANGE  
 Outlet A: WELDED 2-BOLT FLANGE  
 Length: 14.50"

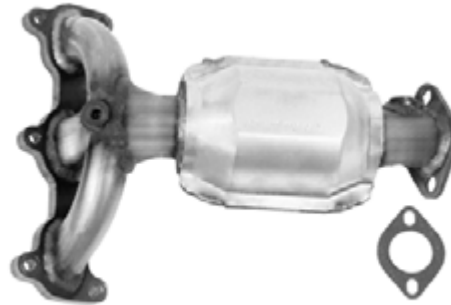

2009-07 6 HYUNDAI SANTA FE 2.7L

### 1143

Inlet A: WELDED 7-BOLT FLANGE  
 Outlet A: WELDED 2-BOLT FLANGE  
 Length: 12"

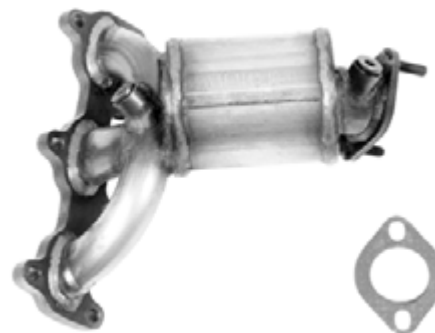

2009-07 6 HYUNDAI SANTA FE 2.7L

# DIRECT FIT

## 1144

Inlet A: LOOSE 2-BOLT FLANGE W/ SPHERICAL FLARE  
 Inlet B: LOOSE 2-BOLT FLANGE W/ SPHERICAL FLARE  
 Outlet A: WELDED 3-BOLT FLANGE  
 Length: 20.25"



2002-01 6 FORD RANGER 3.0L

## 1145

Inlet A: WELDED 3-BOLT FLANGE  
 Outlet A: WELDED 2-BOLT FLANGE  
 Length: 14.50"



2008-07 6 FORD FUSION 3.0L  
 2008-07 6 MERCURY MILAN 3.0L

## 1146

Inlet A: WELDED 5-BOLT FLANGE  
 Outlet A: WELDED 3-BOLT FLANGE  
 Length: 5.75"



2001-99 4 KIA SEPHIA 1.8L  
 2001-00 4 KIA SPECTRA 1.8L

## 1147

Inlet A: WELDED 6-BOLT FLANGE  
 Outlet A: WELDED 2-BOLT FLANGE  
 Length: 13"



2006-01 6 FORD ESCAPE 3.0L  
 2006-01 6 MAZDA TRIBUTE 3.0L  
 2006-05 6 MERCURY MARINER 3.0L

## 1148

Inlet A: WELDED 6-BOLT FLANGE  
 Outlet A: WELDED 2-BOLT FLANGE  
 Length: 16.25"



2006-01 6 FORD ESCAPE 3.0L  
 2006-01 6 MAZDA TRIBUTE 3.0L  
 2006-05 6 MERCURY MARINER 3.0L

## 1149

Inlet A: WELDED 6-BOLT FLANGE  
 Outlet A: WELDED 3-BOLT FLANGE  
 Length: 23.25"



2009-03 6 TOYOTA 4 RUNNER 4.0L  
 2009-07 6 TOYOTA FJ CRUISER 4.0L  
 2008-05 6 TOYOTA TACOMA 4.0L  
 2006-05 6 TOYOTA TUNDRA 4.0L

### 1150

Inlet A: WELDED 6-BOLT FLANGE  
 Outlet A: WELDED 3-BOLT FLANGE  
 Length: 25"



- 2009-03 6 TOYOTA 4 RUNNER 4.0L
- 2009-07 6 TOYOTA FJ CRUISER 4.0L
- 2008-05 6 TOYOTA TACOMA 4.0L
- 2006-05 6 TOYOTA TUNDRA 4.0L

### 1153

Inlet A: WELDED 7-BOLT FLANGE  
 Outlet A: WELDED 2-BOLT FLANGE  
 Length: 26"



- 2008-06 4 MAZDA MIATA, MX5 2.0L

### 1155

Inlet A: WELDED 4-BOLT FLANGE  
 Outlet A: WELDED 3-BOLT FLANGE  
 Length: 14"



- 2006-03 6 ACURA MDX 3.5L
- 2009-07 6 ACURA MDX 3.7L
- 2008-04 6 ACURA TL 3.2L
- 2008-07 6 ACURA TL 3.5L
- 2007-03 6 HONDA ACCORD 3.0L
- 2010-05 6 HONDA ODYSSEY 3.5L
- 2008-05 6 HONDA PILOT 3.5L
- 2008-06 6 HONDA RIDGELINE 3.5L
- 2007-04 6 SATURN VUE 3.5L

### 1156

Inlet A: WELDED 4-BOLT FLANGE  
 Outlet A: WELDED 3-BOLT FLANGE  
 Length: 13.50"

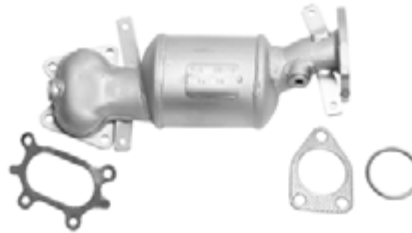

- 2006-03 6 ACURA MDX 3.5L
- 2009-07 6 ACURA MDX 3.7L
- 2008-04 6 ACURA TL 3.2L
- 2008-07 6 ACURA TL 3.5L
- 2007-03 6 HONDA ACCORD 3.0L
- 2010-05 6 HONDA ODYSSEY 3.5L
- 2008-05 6 HONDA PILOT 3.5L
- 2008-06 6 HONDA RIDGELINE 3.5L
- 2007-04 6 SATURN VUE 3.5L

### 1157

Inlet A: WELDED 6-BOLT FLANGE  
 Outlet A: WELDED 2-BOLT FLANGE  
 Length: 14"



- 2011-07 6 LEXUS ES350 3.5L
- 2012-05 6 TOYOTA AVALON 3.5L
- 2011-07 6 TOYOTA CAMRY, (Inc. 1998 & Older SOLARA) 3.5L

### 1158

Inlet A: WELDED 6-BOLT FLANGE  
 Outlet A: WELDED 2-BOLT FLANGE, BENT BRACKET  
 Length: 15"

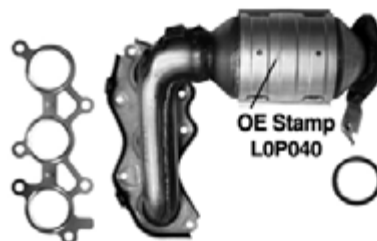

- 2012-05 6 TOYOTA AVALON 3.5L
- 2011-10 6 TOYOTA CAMRY, (Inc. 1998 & Older SOLARA)

# DIRECT FIT

## 1158 (cont.)

2012-09 6 3.5L  
TOYOTA VENZA 3.5L

## 1159

Inlet A: WELDED 6-BOLT FLANGE  
Outlet A: WELDED 2-BOLT FLANGE, STRAIGHT BRACKET  
Length: 15"

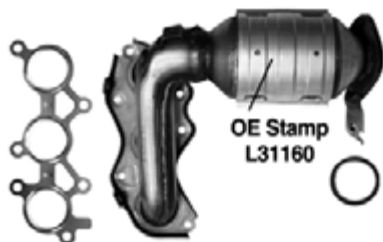

2011-07 6 LEXUS ES350 3.5L  
2008-06 6 TOYOTA AVALON 3.5L  
2009-07 6 TOYOTA CAMRY, (Inc. 1998 & Older SOLARA) 3.5L

## 1160

Inlet A: LOOSE 2-BOLT FLANGE W/ SPHERICAL FLARE  
Inlet B: LOOSE 2-BOLT FLANGE W/ SPHERICAL FLARE  
Outlet A: WELDED 3-BOLT FLANGE W/ GASKET STUB  
Length: 25.50"



2000-99 6 FORD EXPLORER 4.0L

## 1161

Inlet A: WELDED 6-BOLT FLANGE  
Outlet A: WELDED 2-BOLT FLANGE  
Length: 13.50"



2012-09 6 TOYOTA VENZA 3.5L

## 1162

Inlet A: WELDED 9-BOLT FLANGE  
Outlet A: WELDED 2-BOLT FLANGE  
Length: 14.75"



2012-03 4 HYUNDAI ELANTRA 2.0L

## 1163

Inlet A: WELDED 6-BOLT FLANGE  
Outlet A: WELDED 2 BOLT FLANGE  
Length: 13.50"



2009-08 6 TOYOTA HIGHLANDER 3.5L  
2010-07 6 TOYOTA SIENNA 3.5L

## 1164

Inlet A: WELDED 7-BOLT FLANGE  
Outlet A: WELDED 2-BOLT FLANGE  
Length: 11"



2000-95 6 CHRYSLER SEBRING 2.5L  
2000-95 6 DODGE AVENGER 2.5L



### 1165

Inlet A: WELDED 6-BOLT FLANGE  
 Outlet A: WELDED 2-BOLT FLANGE  
 Length: 13.50"

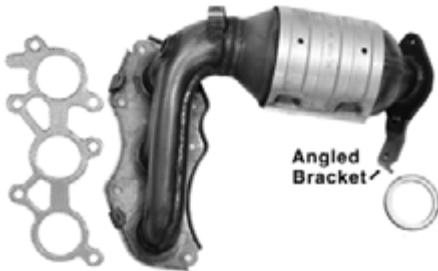

2009-07 6 LEXUS RX350 3.5L  
 2012-06 6 TOYOTA RAV4 3.5L  
 2010-07 6 TOYOTA SIENNA 3.5L

### 1168

Inlet A: WELDED 6-BOLT FLANGE  
 Outlet A: WELDED 2-BOLT FLANGE  
 Length: 14.50"



2012-06 6 TOYOTA RAV4 3.5L

### 1169

Inlet A: WELDED 5-BOLT FLANGE  
 Outlet A: WELDED 3-BOLT FLANGE  
 Length: 19"

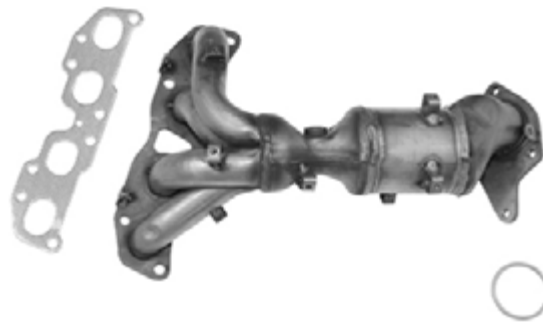

2012-07 4 NISSAN ALTIMA 2.5L

### 1166

Inlet A: WELDED 6-BOLT FLANGE  
 Outlet A: WELDED 2-BOLT FLANGE  
 Length: 16"



2009-07 6 LEXUS RX350 3.5L  
 2010-08 6 TOYOTA HIGHLANDER 3.5L  
 2010-07 6 TOYOTA SIENNA 3.5L

### 1167

Inlet A: WELDED 6-BOLT FLANGE  
 Outlet A: WELDED 2-BOLT FLANGE  
 Length: 14.50"



2010-07 6 TOYOTA SIENNA 3.5L

### 1170

Inlet A: WELDED 6-BOLT FLANGE  
 Outlet A: WELDED 2-BOLT FLANGE  
 Length: 14.50"



2003-02 6 LEXUS ES300 3.0L  
 2006-02 6 TOYOTA CAMRY, (Inc. 1998 & Older SOLARA) 3.0L

# DIRECT FIT

## 1171

Inlet A: WELDED 6-BOLT FLANGE  
 Outlet A: WELDED 2-BOLT FLANGE  
 Length: 14"



- 2006-04 6 LEXUS ES330 3.3L
- 2006-04 6 TOYOTA CAMRY, (Inc. 1998 & Older SOLARA) 3.3L
- 2008-04 6 TOYOTA SOLARA 3.3L

## 1174

Inlet A: WELDED 6-BOLT FLANGE  
 Outlet A: WELDED 2-BOLT FLANGE  
 Length: 16"

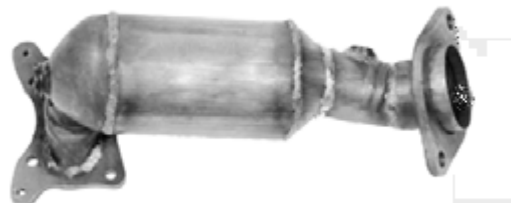

- 2012-09 4 ACURA TSX 2.4L
- 2012-08 4 HONDA ACCORD 2.4L

## 1172

Inlet A: WELDED 6-BOLT FLANGE  
 Outlet A: WELDED 2-BOLT FLANGE  
 Length: 15.50"



- 2003-02 6 LEXUS ES300 3.0L
- 2006-02 6 TOYOTA CAMRY, (Inc. 1998 & Older SOLARA) 3.0L

## 1175

Inlet A: WELDED 5-BOLT FLANGE  
 Outlet A: WELDED 2-BOLT FLANGE  
 Length: 7"



- 2006-03 6 HYUNDAI SANTA FE 3.5L

## 1173

Inlet A: WELDED 6-BOLT FLANGE  
 Outlet A: WELDED 2-BOLT FLANGE  
 Length: 15"



- 2006-04 6 LEXUS ES330 3.3L
- 2006-04 6 TOYOTA CAMRY, (Inc. 1998 & Older SOLARA) 3.3L
- 2008-04 6 TOYOTA SOLARA 3.3L

## 1176

Inlet A: WELDED 5-BOLT FLANGE  
 Outlet A: WELDED 2-BOLT FLANGE  
 Length: 8.63"



- 2006-03 6 HYUNDAI SANTA FE 3.5L

### 1177

Inlet A: 3-BOLT FLANGE W/ SPHERICAL FLARE  
 Inlet B: 3-BOLT FLANGE W/ SPHERICAL FLARE  
 Outlet A: WELDED 3-BOLT FLANGE  
 Length: 36.50"



- 1999-98 6 CHEVROLET S-Series (2WD), T-Series (4WD) PICKUP 4.3L
- 1999-98 6 GMC S-Series (2WD), T-Series (4WD) PICKUP (SONOMA) 4.3L
- 1999-98 6 ISUZU PICKUP 4.3L

### 1178

Inlet A: WELDED 8-BOLT FLANGE  
 Outlet A: WELDED 2-BOLT FLANGE  
 Length: 13.50"

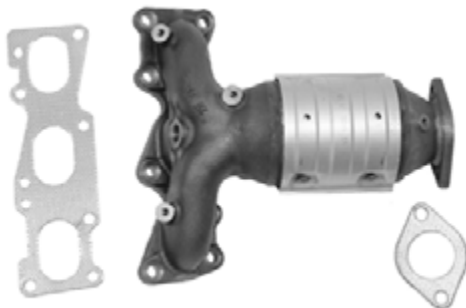

- 2008-07 6 HYUNDAI AZERA 3.3L
- 2010-06 6 HYUNDAI AZERA 3.8L
- 2008-07 6 HYUNDAI ENTOURAGE 3.8L
- 2007-06 6 HYUNDAI SONATA 3.3L
- 2009-07 6 KIA AMANTI 3.8L
- 2010-06 6 KIA SEDONA 3.8L

### 1179

Inlet A: WELDED 8-BOLT FLANGE  
 Outlet A: WELDED 2-BOLT FLANGE  
 Length: 13"



- 2008-07 6 HYUNDAI AZERA 3.3L
- 2010-06 6 HYUNDAI AZERA 3.8L
- 2008-07 6 HYUNDAI ENTOURAGE 3.8L
- 2007-06 6 HYUNDAI SONATA 3.3L
- 2009-07 6 KIA AMANTI 3.8L
- 2010-06 6 KIA SEDONA 3.8L

### 1180

Inlet A: WELDED 9-BOLT FLANGE  
 Outlet A: WELDED 2-BOLT FLANGE  
 Length: 20"



- 2010-06 4 HYUNDAI ELANTRA 2.0L
- 2009-08 4 KIA SPECTRA 2.0L
- 2009-08 4 KIA SPECTRA5 2.0L

### 1181

Inlet A: WELDED 9-BOLT FLANGE  
 Outlet A: WELDED 2-BOLT FLANGE  
 Length: 15.25"

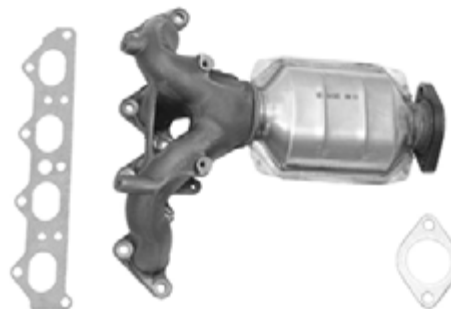

- 2006-05 4 HYUNDAI TUCSON 2.0L
- 2008-05 4 KIA SPORTAGE 2.0L

# DIRECT FIT

## 1182

Inlet A: WELDED 6-BOLT FLANGE  
Outlet A: WELDED 3-BOLT FLANGE  
Length: 10.50"



2006-04 6 NISSAN MAXIMA 3.5L  
2009-04 6 NISSAN QUEST 3.5L

## 1183

Inlet A: WELDED 3-BOLT FLANGE  
Outlet A: WELDED 2-BOLT FLANGE  
Length: 33.50"



2003-02 6 SATURN VUE 3.0L

## 1184

Inlet A: WELDED 6-BOLT FLANGE  
Outlet A: WELDED 2-BOLT FLANGE W/ GASKET STUB  
Length: 16"



2005-03 6 MAZDA 6 3.0L

## 1185

Inlet A: WELDED 6-BOLT FLANGE  
Outlet A: WELDED 2-BOLT FLANGE W/ GASKET STUB  
Length: 13.25"



2005-03 6 MAZDA 6 3.0L

## 1186

Inlet A: WELDED 9-BOLT FLANGE  
Outlet A: WELDED 3-BOLT FLANGE  
Length: 12.50"



2004-01 4 KIA SPECTRA 1.8L

## 1187

Inlet A: WELDED 6-BOLT FLANGE  
Outlet A: WELDED 3-BOLT FLANGE  
Length: 12"



2008-04 6 NISSAN MAXIMA 3.5L  
2006-04 6 NISSAN QUEST 3.5L

**1188**

Inlet A: WELDED 7-BOLT FLANGE  
 Outlet A: WELDED 3-BOLT FLANGE  
 Length: 14.25"



2002-01 4 KIA RIO 1.5L

**1189**

Inlet A: WELDED 4-BOLT FLANGE  
 Outlet A: WELDED 3-BOLT FLANGE  
 Length: 9"



2000-99 4 MAZDA MIATA, MX5 1.8L

**1190**

Inlet A: WELDED 3-BOLT FLANGE  
 Outlet A: WELDED 2-BOLT FLANGE W/ GASKET STUB  
 Length: 20"



2003-02 4 SUZUKI AERIO 2.0L

**1191**

Inlet A: WELDED 9-BOLT FLANGE  
 Outlet A: WELDED 2-BOLT FLANGE  
 Length: 14.75"



2009-04 4 KIA SPECTRA 2.0L

**1192**

Inlet A: 3-BOLT FLANGE W/ SPHERICAL FLARE  
 Inlet B: 3-BOLT FLANGE W/ SPHERICAL FLARE  
 Outlet A: WELDED 3-BOLT FLANGE  
 Length: 34.75"



1999-98 6 CHEVROLET BLAZER S-Series 4.3L

1999-98 6 GMC S-15 JIMMY 4.3L

1999-98 6 OLDSMOBILE BRAVADA 4.3L

**1193**

Inlet A: WELDED 3-BOLT FLANGE  
 Outlet A: WELDED 2-BOLT FLANGE  
 Length: 33"



2003-02 6 SATURN VUE 3.0L

**DIRECT FIT**

**1195**

Inlet A: WELDED 5-BOLT FLANGE  
Outlet A: WELDED 2-BOLT FLANGE W/ GASKET STUB  
Length: 18.88"



- 2006-02 4 NISSAN ALTIMA 2.5L
- 2006-02 4 NISSAN SENTRA 2.5L

**1198**

Inlet A: WELDED 5-BOLT FLANGE  
Outlet A: WELDED 2-BOLT FLANGE  
Length: 19.50"

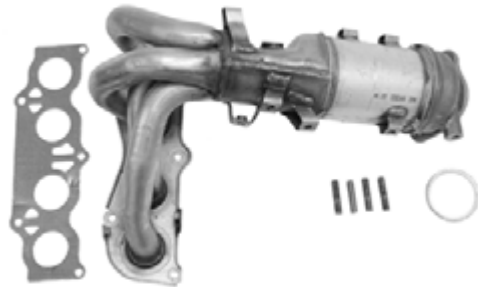

- 2009-07 4 TOYOTA CAMRY, (Inc. 1998 & Older SOLARA) 2.4L
- 2008-06 4 TOYOTA SOLARA 2.4L

**1196**

Inlet A: WELDED 6-BOLT FLANGE  
Outlet A: WELDED 3-BOLT FLANGE  
Length: 13"

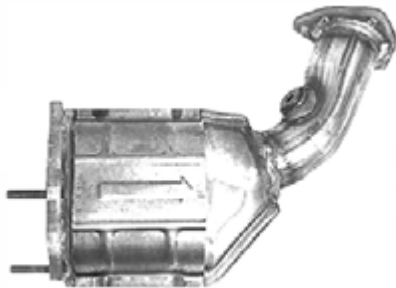

- 2006-02 6 NISSAN ALTIMA 3.5L
- 2007-03 6 NISSAN MURANO 3.5L

**1199**

Inlet A: WELDED 5-BOLT FLANGE  
Outlet A: WELDED 2-BOLT FLANGE  
Length: 19"



- 2009-07 4 TOYOTA CAMRY, (Inc. 1998 & Older SOLARA) 2.4L

**1197**

Inlet A: WELDED 4-BOLT FLANGE W/ GASKET STUB  
Outlet A: WELDED 3-BOLT FLANGE  
Length: 14"



- 2006-02 6 NISSAN ALTIMA 3.5L
- 2008-04 6 NISSAN MAXIMA 3.5L
- 2009-04 6 NISSAN QUEST 3.5L

**1201**

Inlet A: WELDED 5-BOLT FLANGE  
Outlet A: WELDED 2-BOLT FLANGE W/ GASKET STUB  
Length: 19"



- 2003-02 4 NISSAN ALTIMA 2.5L
- 2006-02 4 NISSAN SENTRA 2.5L

### 1202

Inlet A: WELDED 7-BOLT FLANGE  
 Outlet A: WELDED 2-BOLT FLANGE  
 Length: 26"



2009-07 4 FORD FUSION 2.3L  
 2009-07 4 MERCURY MILAN 2.3L

### 1207

Inlet A: WELDED 4-BOLT FLANGE  
 Outlet A: WELDED 2-BOLT FLANGE  
 Length: 15.38"



2011-10 6 CHEVROLET EQUINOX 3.0L  
 2011-10 6 GMC TERRAIN 3.0L

### 1203

Inlet A: WELDED 4-BOLT FLANGE  
 Outlet A: WELDED 2-BOLT FLANGE W/ GASKET STUB  
 Length: 20.25"



2011-06 4 HONDA CIVIC 1.8L

### 1208

Inlet A: WELDED 5-BOLT FLANGE  
 Outlet A: WELDED 2-BOLT FLANGE  
 Length: 6.25"



2006-03 6 KIA SORENTO 3.5L

### 1206

Inlet A: WELDED 4-BOLT FLANGE  
 Outlet A: WELDED 2-BOLT FLANGE  
 Length: 14.50"



2011-10 6 CHEVROLET EQUINOX 3.0L  
 2011-10 6 GMC TERRAIN 3.0L

### 1209

Inlet A: WELDED 7-BOLT FLANGE  
 Outlet A: WELDED 2-BOLT FLANGE  
 Length: 12.75"



2009-05 6 HYUNDAI TUCSON 2.7L  
 2010-05 6 KIA SPORTAGE 2.7L

# DIRECT FIT

## 1211

Inlet A: WELDED 6-BOLT FLANGE  
 Outlet A: WELDED 2-BOLT FLANGE W/ GASKET STUB  
 Length: 22.50"



- 2012-06 6 FORD FUSION 3.0L
- 2006 6 LINCOLN ZEPHYR 3.0L
- 2011-06 6 MERCURY MILAN 3.0L

## 1213

Inlet A: WELDED 8-BOLT FLANGE  
 Outlet A: WELDED 2-BOLT FLANGE  
 Length: 28.38"



- 2009-05 8 LEXUS GX470 4.7L
- 2009-05 8 TOYOTA 4 RUNNER 4.7L

## 1214

Inlet A: WELDED 8-BOLT FLANGE  
 Outlet A: WELDED 2-BOLT FLANGE  
 Length: 28.75"



- 2009-05 8 LEXUS GX470 4.7L
- 2009-05 8 TOYOTA 4 RUNNER 4.7L

## 1215

Inlet A: WELDED 3-BOLT FLANGE  
 Outlet A: WELDED 2-BOLT FLANGE W/ GASKET STUB  
 Length: 24"



- 2002-99 4 SUZUKI ESTEEM 1.8L

## 1216

Inlet A: WELDED 7-BOLT FLANGE  
 Outlet A: WELDED 3-BOLT FLANGE W/ GASKET STUB  
 Length: 24"

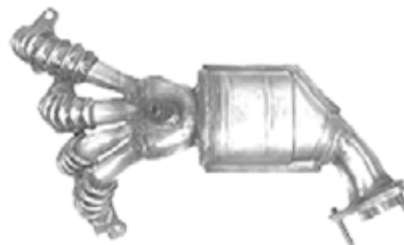

- 2006-04 4 CHEVROLET COLORADO 2.8L
- 2006-04 4 GMC CANYON 2.8L
- 2006 4 ISUZU I-280 2.8L

## 1217

Inlet A: WELDED 7-BOLT FLANGE  
 Outlet A: WELDED 3-BOLT FLANGE  
 Length: 13.50"



- 2002-01 6 MAZDA 626 2.5L



## 1218

Inlet A: WELDED 7-BOLT FLANGE  
 Outlet A: WELDED 3-BOLT FLANGE  
 Length: 10.50"

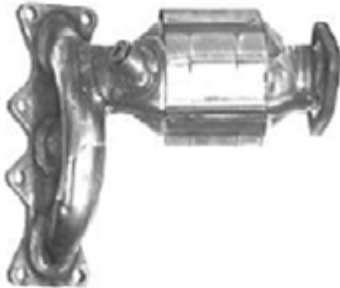

2001-97 6 MAZDA MILLENIA 2.5L

## 1219

Inlet A: WELDED 7-BOLT FLANGE  
 Outlet A: WELDED 3-BOLT FLANGE  
 Length: 9"

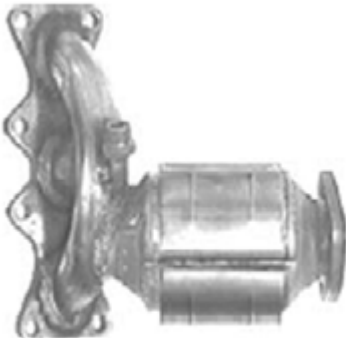

2001-97 6 MAZDA MILLENIA 2.5L

## 1220

Inlet A: WELDED 8-BOLT FLANGE  
 Outlet A: WELDED 2-BOLT FLANGE  
 Length: 13.50"



2009-07 6 HYUNDAI SANTA FE 3.3L  
 2012-07 6 HYUNDAI VERACRUZ 3.8L

## 1221

Inlet A: WELDED 8-BOLT FLANGE  
 Outlet A: WELDED 2-BOLT FLANGE  
 Length: 13.50"



2009-07 6 HYUNDAI SANTA FE 3.3L  
 2012-07 6 HYUNDAI VERACRUZ 3.8L

## 1222

Inlet A: WELDED 4-BOLT FLANGE  
 Outlet A: WELDED 3-BOLT FLANGE  
 Length: 13.75"



2014-13 6 ACURA RDX 3.5L  
 2009 6 ACURA RL 3.7L  
 2014-09 6 ACURA TL 3.5L  
 2014-09 6 ACURA TL 3.7L  
 2014-10 6 ACURA TSX 3.5L  
 2013-10 6 ACURA ZDX 3.7L  
 2011-10 6 HONDA ACCORD CROSSTOUR 3.5L  
 2015-08 6 HONDA ACCORD 3.5L  
 2014-12 6 HONDA CROSSTOUR 3.5L  
 2014-11 6 HONDA ODYSSEY 3.5L  
 2015-09 6 HONDA PILOT 3.5L  
 2014-09 6 HONDA RIDGELINE 3.5L

# DIRECT FIT

## 1226

Inlet A: WELDED 9-BOLT FLANGE  
 Outlet A: WELDED 3-BOLT FLANGE W/ GASKET STUB  
 Length: 27.13"



- 2012-07 5 CHEVROLET COLORADO 3.7L
- 2012-07 5 GMC CANYON 3.7L
- 2008-07 5 HUMMER H3 3.7L
- 2008-07 5 ISUZU I-370 3.7L

## 1227

Inlet A: WELDED 7-BOLT FLANGE  
 Outlet A: WELDED 3-BOLT FLANGE W/ GASKET STUB  
 Length: 24.25"



- 2012-07 4 CHEVROLET COLORADO 2.9L
- 2012-07 4 GMC CANYON 2.9L
- 2008-07 4 ISUZU I-290 2.9L

## 1228

Inlet A: WELDED 7-BOLT FLANGE  
 Outlet A: WELDED 2-BOLT FLANGE  
 Length: 12"



- 2009-07 6 HYUNDAI SANTA FE 2.7L

## 1231

Inlet A: WELDED 10-BOLT FLANGE  
 Outlet A: WELDED 3-BOLT FLANGE  
 Length: 17.75"



- 2008-04 4 CHEVROLET MALIBU 2.2L
- 2010-08 4 CHEVROLET MALIBU 2.4L
- 2010-06 4 PONTIAC G6 2.4L
- 2009-07 4 SATURN AURA 2.4L

## 1232

Inlet A: WELDED 4-BOLT FLANGE  
 Outlet A: WELDED 3-BOLT FLANGE  
 Length: 14"



- 2010-08 6 HONDA ODYSSEY 3.5L

## 1233

Inlet A: WELDED 4-BOLT FLANGE  
 Outlet A: WELDED 3-BOLT FLANGE  
 Length: 14"



2010-08 6 HONDA ODYSSEY 3.5L

## 1234

Inlet A: WELDED 9-BOLT FLANGE  
 Outlet A: WELDED 2-BOLT FLANGE  
 Length: 15.13"



2012-03 4 HYUNDAI ELANTRA 2.0L  
 2008-07 4 HYUNDAI TIBURON 2.0L  
 2011-10 4 KIA SOUL 2.0L  
 2009-04 4 KIA SPECTRA 2.0L  
 2009-06 4 KIA SPECTRA5 2.0L

## 1236

Inlet A: WELDED 6-BOLT FLANGE  
 Outlet A: WELDED 3-BOLT FLANGE  
 Length: 10"



2008-07 6 NISSAN ALTIMA 3.5L

## 1237

Inlet A: WELDED 4-BOLT FLANGE  
 Outlet A: WELDED 3-BOLT FLANGE  
 Length: 12.50"



2008-07 6 NISSAN ALTIMA 3.5L

## 1238

Inlet A: WELDED 3-BOLT FLANGE  
 Outlet A: WELDED 2-BOLT FLANGE  
 Length: 40.25"



2010-08 6 PONTIAC G6 3.5L

## 1239

Inlet A: WELDED 3-BOLT FLANGE  
 Inlet B: WELDED 2-BOLT FLANGE  
 Outlet A: WELDED 2-BOLT FLANGE  
 Length: 29"



2010-08 6 PONTIAC G6 3.5L

# DIRECT FIT

## 1250

Inlet A: WELDED 4-BOLT FLANGE  
 Outlet A: WELDED 3-BOLT FLANGE  
 Length: 13.75"



- 2006-03 6 ACURA MDX 3.5L
- 2009-07 6 ACURA MDX 3.7L
- 2008-04 6 ACURA TL 3.2L
- 2008-07 6 ACURA TL 3.5L
- 2007-03 6 HONDA ACCORD 3.0L
- 2010-05 6 HONDA ODYSSEY 3.5L
- 2008-05 6 HONDA PILOT 3.5L
- 2008-06 6 HONDA RIDGELINE 3.5L
- 2007-04 6 SATURN VUE 3.5L

## 1251

Inlet A: WELDED 4-BOLT FLANGE  
 Outlet A: WELDED 3-BOLT FLANGE  
 Length: 13.90"



- 2006-03 6 ACURA MDX 3.5L
- 2009-07 6 ACURA MDX 3.7L
- 2008-04 6 ACURA TL 3.2L
- 2008-07 6 ACURA TL 3.5L
- 2007-03 6 HONDA ACCORD 3.0L
- 2010-05 6 HONDA ODYSSEY 3.5L
- 2008-05 6 HONDA PILOT 3.5L
- 2008-06 6 HONDA RIDGELINE 3.5L
- 2007-04 6 SATURN VUE 3.5L

## 1260

Inlet A: WELDED 7-BOLT FLANGE  
 Outlet A: WELDED 2-BOLT FLANGE  
 Length: 15.25"



2006-01 6 HYUNDAI SANTA FE 2.7L

## 1261

Inlet A: WELDED 7-BOLT FLANGE  
 Outlet A: WELDED 2-BOLT FLANGE  
 Length: 14.50"



2004-01 6 HYUNDAI SANTA FE 2.7L

## 1271

Inlet A: WELDED 9-BOLT FLANGE  
 Outlet A: WELDED 3-BOLT FLANGE  
 Length: 13.63"



2007-02 4 MITSUBISHI LANCER 2.0L

**1272**

Inlet A: WELDED 6-BOLT FLANGE  
 Outlet A: WELDED 4-BOLT FLANGE  
 Length: 15"



2004-02 6 VOLVO S80 2.9L

**1273**

Inlet A: WELDED 6-BOLT FLANGE  
 Outlet A: WELDED 4-BOLT FLANGE  
 Length: 15"



2004-02 6 VOLVO S80 2.9L

**1274**

Inlet A: WELDED 5-BOLT FLANGE  
 Outlet A: WELDED 2-BOLT FLANGE W/GASKET STUB  
 Length: 17.50"



2005-03 4 HONDA CIVIC 1.3L

**1275**

Inlet A: WELDED 6-BOLT FLANGE  
 Outlet A: WELDED 3-BOLT FLANGE  
 Length: 18"



2006-04 6 SUZUKI VERONA 2.5L

**1276**

Inlet A: WELDED 8-BOLT FLANGE  
 Outlet A: WELDED 3-BOLT FLANGE  
 Length: 17"



2006-04 6 SUZUKI VERONA 2.5L

**1277**

Inlet A: WELDED 3-BOLT FLANGE  
 Outlet A: WELDED 3-BOLT FLANGE  
 Length: 8.25"



2000-98 6 CHRYSLER SEBRING 2.5L  
 2000-98 6 DODGE AVENGER 2.5L

**1278**

Inlet A: WELDED 3-BOLT FLANGE  
 Outlet A: WELDED 3-BOLT FLANGE  
 Length: 12"



2000-98 6 CHRYSLER SEBRING 2.5L  
 2000-98 6 DODGE AVENGER 2.5L

# DIRECT FIT

## 1279

Inlet A: WELDED 6-BOLT FLANGE  
Outlet A: WELDED 2-BOLT FLANGE W/GASKET STUB  
Length: 19"



2007 6 CHRYSLER PACIFICA 4.0L

## 1280

Inlet A: WELDED 2-BOLT FLANGE  
Outlet A: WELDED 2-BOLT FLANGE W/MALE BALL  
Length: 18"



2016-11 6 CHRYSLER TOWN & COUNTRY 3.6L  
2014-11 6 DODGE AVENGER 3.6L  
2016-11 6 DODGE CARAVAN 3.6L  
2014-11 6 DODGE JOURNEY 3.6L

## 1281

Inlet A: WELDED 2-BOLT FLANGE  
Outlet A: WELDED 2-BOLT FLANGE  
Length: 18"



2016-11 6 CHRYSLER TOWN & COUNTRY 3.6L  
2014-11 6 DODGE AVENGER 3.6L  
2016-11 6 DODGE CARAVAN 3.6L  
2014-11 6 DODGE JOURNEY 3.6L

## 1282

Inlet A: LOOSE 2-BOLT FLANGE W/ FLARE  
Inlet B: LOOSE 2-BOLT FLANGE W/ FLARE  
Outlet A: WELDED 3-BOLT FLANGE  
Length: 15.50"



2005-04 6 FORD EXPLORER 4.0L

## 1283

Inlet A: WELDED 6-BOLT FLANGE  
Outlet A: WELDED 2-BOLT FLANGE W/MALE BALL  
Length: 16.5"



2008 6 FORD ESCAPE 3.0L  
2008 6 MAZDA TRIBUTE 3.0L  
2008 6 MERCURY MARINER 3.0L

## 1284

Inlet A: WELDED 3-BOLT FLANGE  
Outlet A: WELDED 2-BOLT FLANGE  
Length: 14.63"



2012-10 6 FORD FUSION 3.0L  
2011-10 6 MERCURY MILAN 3.0L

### 1285

Inlet A: WELDED 6-BOLT FLANGE  
 Outlet A: WELDED 2-BOLT FLANGE  
 Length: 14"



- 2014-11 6 FORD EDGE 3.5L
- 2014-11 6 FORD EDGE 3.7L
- 2013-11 6 FORD EXPLORER 3.5L
- 2014-11 6 LINCOLN MKX 3.7L

### 1288

Inlet A: WELDED 6-BOLT FLANGE  
 Outlet A: WELDED 2-BOLT FLANGE W/MALE BALL  
 Length: 14.63"



- 2012-09 6 FORD ESCAPE 3.0L
- 2011-09 6 MAZDA TRIBUTE 3.0L

### 1286

Inlet A: WELDED 4-BOLT FLANGE  
 Outlet A: WELDED 2-BOLT FLANGE  
 Length: 11.25"



- 2013-11 6 FORD EDGE 3.5L
- 2013-11 6 FORD EXPLORER 3.5L
- 2014-11 6 LINCOLN MKX 3.7L

### 1289

Inlet A: WELDED 3-BOLT FLANGE  
 Outlet A: WELDED 2-BOLT FLANGE  
 Length: 10"



- 2012-10 6 FORD ESCAPE 3.0L
- 2011-09 6 MAZDA TRIBUTE 3.0L
- 2011-10 6 MERCURY MARINER 3.0L

### 1287

Inlet A: WELDED 7-BOLT FLANGE  
 Outlet A: WELDED 2-BOLT FLANGE  
 Length: 32"



- 2010-09 4 FORD FOCUS 2.0L

### 1290

Inlet A: WELDED 4-BOLT FLANGE  
 Outlet A: WELDED 2-BOLT FLANGE  
 Length: 11.50"



- 2013-09 6 MAZDA 6 3.7L
- 2007 6 MAZDA CX-9 3.5L
- 2015-08 6 MAZDA CX-9 3.7L

# DIRECT FIT

## 1291

Inlet A: WELDED 6-BOLT FLANGE  
 Inlet B: WELDED 3-BOLT FLANGE  
 Outlet A: WELDED 2-BOLT FLANGE  
 Length: 22"



2002-99 6 MERCURY VILLAGER 3.3L  
 2002-99 6 NISSAN QUEST 3.3L

## 1292

Inlet A: WELDED 8-BOLT FLANGE  
 Outlet A: WELDED 2-BOLT FLANGE  
 Length: 34"



2008-02 4 MINI COOPER 1.6L

## 1293

Inlet A: WELDED 8-BOLT FLANGE  
 Outlet A: WELDED 2-BOLT FLANGE  
 Length: 32"



2003-01 6 BMW 525 2.5L  
 2003-01 6 BMW 530 3.0L  
 2006-01 6 BMW X5 3.0L

## 1294

Inlet A: WELDED 8-BOLT FLANGE  
 Outlet A: WELDED 2-BOLT FLANGE  
 Length: 23"



2003-01 6 BMW 525 2.5L  
 2003-01 6 BMW 530 3.0L  
 2006-01 6 BMW X5 3.0L

## 1295

Inlet A: WELDED 7-BOLT FLANGE  
 Outlet A: WELDED 2-BOLT FLANGE  
 Length: 18"

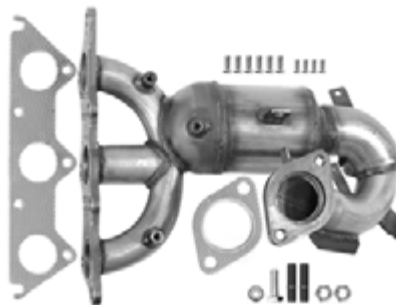

2012-06 6 MITSUBISHI ECLIPSE 3.8L  
 2009-04 6 MITSUBISHI GALANT 3.8L

## 1296

Inlet A: WELDED 6-BOLT FLANGE  
 Outlet A: WELDED 2-BOLT FLANGE  
 Length: 17"



2008-06 6 LEXUS RX400H 3.3L  
 2010-06 6 TOYOTA HIGHLANDER 3.3L



### 1297

Inlet A: WELDED 5-BOLT FLANGE  
 Outlet A: WELDED 2-BOLT FLANGE W/MALE BALL  
 Length: 21"



2010-09 4 PONTIAC VIBE 2.4L  
 2010-07 4 SCION TC 2.4L  
 2010-09 4 TOYOTA COROLLA 2.4L  
 2013-09 4 TOYOTA MATRIX 2.4L

### 1298

Inlet A: WELDED 3-BOLT FLANGE W/ MALE BALL  
 Outlet A: WELDED 5-BOLT FLANGE  
 Length: 14"



2011-05 4 SAAB 9-3 2.0L

### 1299

Inlet A: WELDED 5-BOLT FLANGE  
 Outlet A: WELDED 3-BOLT FLANGE  
 Length: 18"



2005-00 4 TOYOTA MR2 SPYDER 1.8L

### 1300

Inlet A: WELDED 6-BOLT FLANGE  
 Outlet A: WELDED 2-BOLT FLANGE  
 Length: 28.50"



2012-06 6 LEXUS IS250 2.5L

### 1301

Inlet A: WELDED 6-BOLT FLANGE  
 Outlet A: WELDED 2-BOLT FLANGE  
 Length: 28.50"



2012-06 6 LEXUS IS250 2.5L

### 1302

Inlet A: WELDED 6-BOLT FLANGE  
 Outlet A: WELDED 2-BOLT FLANGE  
 Length: 34"



2009-06 4 MAZDA 3 2.3L  
 2010-08 4 MAZDA 5 2.3L

### 1303

Inlet A: WELDED 8-BOLT FLANGE  
 Outlet A: WELDED 2-BOLT FLANGE  
 Length: 30"



2006-04 4 MAZDA 3 2.0L

# DIRECT FIT

## 1304

Inlet A: WELDED 5-BOLT FLANGE  
 Outlet A: WELDED 3-BOLT FLANGE  
 Length: 23"



2016-05 4 NISSAN FRONTIER 2.5L  
 2012-09 4 SUZUKI EQUATOR 2.5L

## 1305

Inlet A: WELDED 7-BOLT FLANGE  
 Outlet A: WELDED 2-BOLT FLANGE W/GASKET STUB  
 Length: 23"



2006-05 4 MAZDA 6 2.3L

## 1306

Inlet A: WELDED 5-BOLT FLANGE  
 Outlet A: WELDED 2-BOLT FLANGE W/GASKET STUB  
 Length: 21"



2013-11 4 SCION TC 2.5L  
 2012-09 4 TOYOTA RAV4 2.5L

## 1307

Inlet A: WELDED 7-BOLT FLANGE  
 Outlet A: WELDED 2-BOLT FLANGE  
 Length: 32.75"



2006-04 4 MAZDA 3 2.0L

## 1308

Inlet A: WELDED 4-BOLT FLANGE  
 Outlet A: WELDED 3-BOLT FLANGE  
 Length: 14"



2013-07 6 MITSUBISHI OUTLANDER 3.0L

## 1309

Inlet A: WELDED 4-BOLT FLANGE  
 Outlet A: WELDED 2-BOLT FLANGE  
 Length: 14"



2013-07 6 MITSUBISHI OUTLANDER 3.0L

## 1310

Inlet A: WELDED 4-BOLT FLANGE  
 Outlet A: WELDED 3-BOLT FLANGE  
 Length: 14"



2014-13 6 ACURA RDX 3.5L  
 2009 6 ACURA RL 3.7L  
 2014-09 6 ACURA TL 3.5L  
 2014-09 6 ACURA TL 3.7L  
 2014-10 6 ACURA TSX 3.5L  
 2013-10 6 ACURA ZDX 3.7L  
 2011-10 6 HONDA ACCORD CROSSTOUR 3.5L

## 1310 (cont.)

2015-08	6	HONDA ACCORD 3.5L
2014-12	6	HONDA CROSSTOUR 3.5L
2014-11	6	HONDA ODYSSEY 3.5L
2011-09	6	HONDA PILOT 3.5L
2011-09	6	HONDA RIDGELINE 3.5L

## 1311

Inlet A: WELDED 5-BOLT FLANGE  
 Outlet A: WELDED 2-BOLT FLANGE W/GASKET STUB  
 Length: 21"



2007-04	4	TOYOTA HIGHLANDER 2.4L
---------	---	------------------------

## 1312

Inlet A: WELDED 4-BOLT FLANGE  
 Outlet A: WELDED 2-BOLT FLANGE W/GASKET STUB  
 Length: 14"



2011-10	4	HONDA CRV 2.4L
---------	---	----------------

## 1313

Inlet A: WELDED 9-BOLT FLANGE  
 Outlet A: WELDED 4-BOLT FLANGE  
 Length: 22"



2008-06	6	SUZUKI VITARA, GRAND VITARA 2.7L
2006-04	6	SUZUKI XL-7 2.7L

## 1314

Inlet A: WELDED 9-BOLT FLANGE  
 Outlet A: WELDED 4-BOLT FLANGE  
 Length: 21"



2008-06	6	SUZUKI VITARA, GRAND VITARA 2.7L
2006-04	6	SUZUKI XL-7 2.7L

## 1315

Inlet A: WELDED 3-BOLT FLANGE  
 Outlet A: 2.25" O.D. PIPE  
 Length: 17"



2003-02	6	JAGUAR X-TYPE 2.5L
2003-02	6	JAGUAR X-TYPE 3.0L

## 1316

Inlet A: WELDED 3-BOLT FLANGE  
 Outlet A: 60MM I.D. PIPE  
 Length: 17"



2003-02	6	JAGUAR X-TYPE 2.5L
2003-02	6	JAGUAR X-TYPE 3.0L

# DIRECT FIT

## 1317

Inlet A: WELDED 10-BOLT FLANGE  
Outlet A: FLARED PIPE  
Length: 19.25"



2015-07 4 MINI COOPER 1.6L

## 1318

Inlet A: WELDED 6-BOLT FLANGE  
Outlet A: WELDED 3-BOLT FLANGE W/GASKET STUB  
Length: 14.75"



2011-06 4 HONDA CIVIC 1.3L

## 1319

Inlet A: WELDED 8-BOLT FLANGE  
Outlet A: WELDED 4-BOLT FLANGE  
Length: 13.50"



2012-08 8 LAND ROVER LR2 3.2L

## 1320

Inlet A: WELDED 8-BOLT FLANGE  
Outlet A: WELDED 4-BOLT FLANGE  
Length: 13.50"



2012-08 8 LAND ROVER LR2 3.2L

## 1321

Inlet A: WELDED 6-BOLT FLANGE  
Outlet A: WELDED 3-BOLT FLANGE  
Length: 10.25"

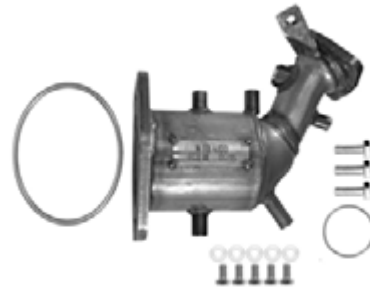

2015-09 6 NISSAN MAXIMA 3.5L

## 1322

Inlet A: WELDED 4-BOLT FLANGE  
Outlet A: WELDED 3-BOLT FLANGE  
Length: 11.50"

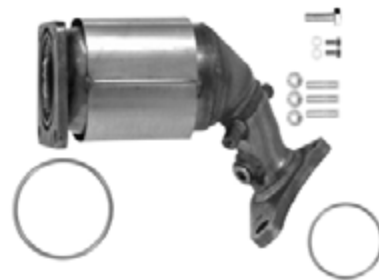

2015-09 6 NISSAN MAXIMA 3.5L

### 1323

Inlet A: WELDED 12-BOLT FLANGE  
 Outlet A: WELDED 4-BOLT FLANGE  
 Length: 20"



2006-04 5 VOLVO S40/V40 2.4L  
 2006-05 5 VOLVO V50 2.4L

### 1324

Inlet A: WELDED 5-BOLT FLANGE  
 Outlet A: WELDED 3-BOLT FLANGE  
 Length: 21"



2015-13 4 NISSAN ALTIMA 2.5L

### 1325

Inlet A: WELDED 5-BOLT FLANGE  
 Outlet A: WELDED 3-BOLT FLANGE  
 Length: 17.75"



2015-14 4 NISSAN ROGUE SELECT 2.5L  
 2013-08 4 NISSAN ROGUE 2.5L  
 2008-07 4 NISSAN X-TRAIL 2.5L

### 1326

Inlet A: WELDED 3-BOLT FLANGE  
 Outlet A: WELDED 2-BOLT FLANGE  
 Length: 14"



2012-10 4 HYUNDAI GENESIS COUPE 2.0L

### 1327

Inlet A: V-BAND CLAMP  
 Outlet A: WELDED 2-BOLT FLANGE W/GASKET STUB  
 Length: 21"



2011-10 8 BMW 550I GT XDRIVE 4.4L  
 2011-10 8 BMW 550I GT 4.4L  
 2011 8 BMW 550I XDRIVE 4.4L  
 2011 8 BMW 550I 4.4L  
 2012 8 BMW 650I XDRIVE 4.4L  
 2012 8 BMW 650I 4.4L  
 2011-10 8 BMW 750I XDRIVE 4.4L  
 2011-09 8 BMW 750I 4.4L  
 2011-10 8 BMW 750LI XDRIVE 4.4L  
 2011-10 8 BMW 750LI 4.4L  
 2011-10 8 BMW X5 4.4L  
 2011-08 8 BMW X6 4.4L

### 1328

Inlet A: V-BAND CLAMP  
 Outlet A: WELDED 2-BOLT FLANGE W/GASKET STUB  
 Length: 22"



2011-10 8 BMW 550I GT XDRIVE 4.4L  
 2011-10 8 BMW 550I GT 4.4L

**DIRECT FIT**

**1328 (cont.)**

2011	8	BMW 550I XDRIVE 4.4L
2011	8	BMW 550I 4.4L
2012	8	BMW 650I XDRIVE 4.4L
2012	8	BMW 650I 4.4L
2011-10	8	BMW 750I XDRIVE 4.4L
2011-09	8	BMW 750I 4.4L
2011-10	8	BMW 750LI XDRIVE 4.4L
2011-10	8	BMW 750LI 4.4L
2011-10	8	BMW X5 4.4L
2011-08	8	BMW X6 4.4L

**1329**

**Inlet A: WELDED 5-BOLT FLANGE**  
**Outlet A: WELDED 5-BOLT FLANGE W/MALE BALL**  
Length: 14"



2012-09 4 NISSAN SENTRA 2.0L

**1330**

**Inlet A: WELDED 8-BOLT FLANGE**  
**Outlet A: WELDED 4-BOLT FLANGE**  
Length: 13"



2010-07 6 VOLVO XC90 3.2L

**1331**

**Inlet A: WELDED 8-BOLT FLANGE**  
**Outlet A: WELDED 4-BOLT FLANGE**  
Length: 15.50"



2010-07 6 VOLVO XC90 3.2L

**1335**

**Inlet A: WELDED 8-BOLT FLANGE**  
**Outlet A: WELDED 2-BOLT FLANGE**  
Length: 28"



2005-03 8 LEXUS GX470 4.7L  
2004-03 8 TOYOTA 4 RUNNER 4.7L

**1336**

**Inlet A: WELDED 8-BOLT FLANGE**  
**Outlet A: WELDED 2-BOLT FLANGE**  
Length: 28"



2005-03 8 LEXUS GX470 4.7L  
2004-03 8 TOYOTA 4 RUNNER 4.7L

### 1337

Inlet A: WELDED 8-BOLT FLANGE  
 Outlet A: WELDED 2-BOLT FLANGE  
 Length: 32"



2005-04 6 BMW 525 2.5L  
 2005-04 6 BMW 530 3.0L

### 1338

Inlet A: WELDED 8-BOLT FLANGE  
 Outlet A: WELDED 2-BOLT FLANGE  
 Length: 21"



2005-04 6 BMW 525 2.5L  
 2005-04 6 BMW 530 3.0L

### 1339

Inlet A: WELDED 7-BOLT FLANGE  
 Outlet A: WELDED 2-BOLT FLANGE  
 Length: 14"



2009-07 6 HYUNDAI SANTA FE 2.7L  
 2008-06 6 KIA OPTIMA 2.7L  
 2010-07 6 KIA RONDO 2.7L

### 1340

Inlet A: WELDED 3-BOLT FLANGE  
 Outlet A: 3.13" FLARE  
 Length: 23.50"



2015-07 4 MINI COOPER 1.6L

### 1341

Inlet A: WELDED 7-BOLT FLANGE  
 Outlet A: WELDED 2-BOLT FLANGE  
 Length: 15.25"



2008-05 6 HYUNDAI TUCSON 2.7L  
 2010-05 6 KIA SPORTAGE 2.7L

### 1342

Inlet A: WELDED 8-BOLT FLANGE  
 Outlet A: WELDED 2-BOLT FLANGE  
 Length: 29"



2009-04 8 CADILLAC SRX 4.6L  
 2010-05 8 CADILLAC STS 4.6L

# DIRECT FIT

## 1343

Inlet A: WELDED 8-BOLT FLANGE  
 Outlet A: WELDED 2-BOLT FLANGE  
 Length: 29"



2009-04 8 CADILLAC SRX 4.6L  
 2010-05 8 CADILLAC STS 4.6L

## 1344

Inlet A: WELDED 4-BOLT FLANGE  
 Outlet A: WELDED 2-BOLT FLANGE  
 Length: 16"



2010 6 BUICK ALLURE 3.0L  
 2010 6 BUICK LACROSSE 3.0L

## 1345

Inlet A: WELDED 4-BOLT FLANGE  
 Outlet A: WELDED 2-BOLT FLANGE  
 Length: 12.75"



2010 6 BUICK ALLURE 3.0L  
 2010 6 BUICK LACROSSE 3.0L

## 1347

Inlet A: WELDED 4-BOLT FLANGE  
 Outlet A: WELDED 2-BOLT FLANGE  
 Length: 19"



2013-12 6 CHEVROLET IMPALA FWD 3.6L

## 1348

Inlet A: WELDED 4-BOLT FLANGE  
 Outlet A: WELDED 2-BOLT FLANGE  
 Length: 15.50"



2013-12 6 CHEVROLET IMPALA FWD 3.6L

## 1349

Inlet A: WELDED 9-BOLT FLANGE  
 Outlet A: WELDED 3-BOLT FLANGE  
 Length: 20"

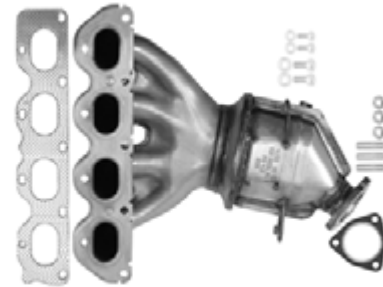

2014-11 4 CHEVROLET CRUZE 1.8L  
 2014-12 4 CHEVROLET SONIC 1.8L

## 1350

Inlet A: WELDED 4-BOLT FLANGE  
 Outlet A: WELDED 2-BOLT FLANGE  
 Length: 14"



2012 6 CHEVROLET EQUINOX 3.0L  
 2015-13 6 CHEVROLET EQUINOX 3.6L  
 2012 6 GMC TERRAIN 3.0L  
 2015-13 6 GMC TERRAIN 3.6L



### 1600

Inlet A: WELDED 6-BOLT FLANGE  
 Outlet A: WELDED 2-BOLT FLANGE  
 Length: 16.50"



2008-06 6 MAZDA 6 3.0L

### 1601

Inlet A: WELDED 6-BOLT FLANGE  
 Outlet A: WELDED 2-BOLT FLANGE  
 Length: 16.50"



2008-06 6 MAZDA 6 3.0L

### 1900

Inlet A: WELDED 7-BOLT FLANGE  
 Outlet A: WELDED 2-BOLT FLANGE  
 Length: 16"



2010-06 6 MITSUBISHI ECLIPSE 3.8L  
 2009-07 6 MITSUBISHI GALANT 3.8L

### 1901

Inlet A: WELDED 7-BOLT FLANGE  
 Outlet A: WELDED 2-BOLT FLANGE  
 Length: 12.50"



2010-06 6 MITSUBISHI ECLIPSE 3.8L  
 2009-07 6 MITSUBISHI GALANT 3.8L

### 4001

Inlet A: 2.50" I.D. PIPE  
 Outlet A: 2.50" O.D. PIPE  
 Length: 24.75"



- |         |   |  |
|---------|---|--|
| 1980-77 | 6 | CHEVROLET MARATHON All   |
| 1985    | 6 | CHEVROLET ASTRO VAN 4.3L   |
| 1982-75 | 6 | CHEVROLET BLAZER FULL SIZE 4.1L  |
| 1982-75 | 8 | CHEVROLET BLAZER FULL SIZE All   |
| 1982-75 | 6 | CHEVROLET C-(2WD), K-(4WD) PICKUP 1/2 TON, (Inc. SILVERADO & AVALANCHE) All  |
| 1986-83 | 8 | CHEVROLET C-(2WD), K-(4WD) PICKUP 1/2 TON, (Inc. SILVERADO & AVALANCHE) 5.0L |
| 1982-75 | 8 | CHEVROLET C-(2WD), K-(4WD) PICKUP 1/2 TON, (Inc. SILVERADO & AVALANCHE) All  |
| 1984-83 | 6 | CHEVROLET G -VAN 1/2 & 3/4 TON (Inc. Express Van) 4.1L                       |
| 1976-75 | 8 | CHEVROLET G -VAN 1/2 & 3/4 TON (Inc. Express Van) 5.7L                       |
| 1982-79 | 8 | CHEVROLET G -VAN 1/2 & 3/4 TON (Inc. Express Van) All                        |
| 1982-75 | 6 | GMC C-(2WD), K-(4WD) PICKUP 1/2 TON, (Inc. SIERRA) All                       |
| 1986-83 | 8 | GMC C-(2WD), K-(4WD) PICKUP 1/2 TON, (Inc. SIERRA) 5.0L                      |
| 1982-75 | 8 | GMC C-(2WD), K-(4WD) PICKUP 1/2 TON, (Inc. SIERRA) All                       |
| 1976-75 | 8 | GMC G -VAN 1/2 & 3/4 TON (Inc. Savana Van) 5.7L                              |
| 1982-79 | 8 | GMC G -VAN 1/2 & 3/4 TON (Inc. Savana Van) All                               |
| 1984-83 | 6 | GMC G -VAN 1/2 & 3/4 TON (Inc. Savana Van) 4.1L                              |
| 1982-75 | 6 | GMC JIMMY FULL SIZE 4.1L   |
| 1982-75 | 8 | GMC JIMMY FULL SIZE All  |
| 1985    | 6 | GMC SAFARI VAN 4.3L  |

**DIRECT FIT**

**4003**

Inlet A: WELDED 2-BOLT FLANGE W/ GASKET STUB  
Inlet B: LOOSE 2-BOLT FLANGE W/ SPHERICAL FLARE  
Outlet A: WELDED 2-BOLT FLANGE  
Length: 21.75"



2000-99 6 MITSUBISHI MONTERO SPORT 3.0L

**4004**

Inlet A: WELDED 2-BOLT FLANGE W/ FEMALE FLARE  
Outlet A: 2.12" O.D. PIPE  
Length: 20.50"



2008-06 6 LEXUS RX400H 3.3L  
2007-06 6 TOYOTA HIGHLANDER 3.3L

**4005**

Inlet A: WELDED 2-BOLT FLANGE W/ GASKET STUB  
Outlet A: WELDED 2-BOLT FLANGE  
Length: 29.13"



2010-07 8 INFiniti QX56 5.6L  
2015-07 8 NISSAN ARMADA 5.6L  
2015-07 8 NISSAN TITAN 5.6L

**4007**

Inlet A: WELDED 3-BOLT FLANGE W/ GASKET STUB  
Inlet B: WELDED 3-BOLT FLANGE W/ GASKET STUB  
Outlet A: WELDED 2-BOLT FLANGE  
Length: 43"



2012-09 6 NISSAN MURANO 3.5L

**4010**

Inlet A: WELDED 3-BOLT FLANGE  
Outlet A: WELDED 3-BOLT FLANGE  
Length: 10.75"



2014-13 6 ACURA RDX 3.5L  
2009 6 ACURA RL 3.7L  
2014-09 6 ACURA TL 3.5L  
2014-09 6 ACURA TL 3.7L  
2014-10 6 ACURA TSX 3.5L  
2013-10 6 ACURA ZDX 3.7L  
2011-10 6 HONDA ACCORD CROSSTOUR 3.5L  
2012-08 6 HONDA ACCORD 3.5L  
2014-11 6 HONDA ODYSSEY 3.5L  
2014-09 6 HONDA PILOT 3.5L  
2014-09 6 HONDA RIDGELINE 3.5L

**4011**

Inlet A: WELDED 2-BOLT FLANGE W/ FEMALE FLARE  
Outlet A: 2.56" O.D. PIPE  
Length: 47"



2016-12 4 TOYOTA CAMRY, (Inc. 1998 & Older SOLARA) 2.5L

### 4012

Inlet A: WELDED 2-BOLT FLANGE  
 Outlet A: 2.25" I.D. PIPE  
 Length: 39"



2015-10 4 CHEVROLET EQUINOX 2.4L  
 2015-10 4 GMC TERRAIN 2.4L

### 4013

Inlet A: WELDED 2-BOLT FLANGE  
 Outlet A: WELDED 2-BOLT FLANGE  
 Length: 27"



2015-14 4 NISSAN ROGUE SELECT 2.5L  
 2013-08 4 NISSAN ROGUE 2.5L

### 4014

Inlet A: WELDED 3-BOLT FLANGE W/ GASKET STUB  
 Inlet B: WELDED 3-BOLT FLANGE W/ GASKET STUB  
 Outlet A: WELDED 2-BOLT FLANGE  
 Length: 38.50"



2001-00 6 INFiniti I30 3.0L  
 2001-00 6 NISSAN MAXIMA 3.0L

### 4015

Inlet A: WELDED 3-BOLT FLANGE  
 Outlet A: WELDED 2-BOLT FLANGE  
 Length: 36.75"



2007-05 4 CHEVROLET COBALT 2.2L  
 2007-06 4 CHEVROLET COBALT 2.4L  
 2007-06 4 CHEVROLET HHR 2.2L  
 2007-06 4 CHEVROLET HHR 2.4L  
 2007 4 PONTIAC G5 2.2L  
 2007 4 PONTIAC G5 2.4L  
 2007-05 4 SATURN ION 2.2L  
 2007-06 4 SATURN ION 2.4L

### 4019

Inlet A: 2.25" I.D. PIPE  
 Outlet A: LOOSE GM FLANGE W/ 2.25" MALE BALL  
 Length: 20.50"



1987-83 6 CHEVROLET BLAZER S-Series 2.8L  
 1988-83 4 CHEVROLET BLAZER S-Series All  
 1980 6 CHEVROLET EL CAMINO 3.8L  
 1993-87 4 CHEVROLET LLV 2.5L  
 1980 6 CHEVROLET MALIBU 3.8L  
 1980 6 CHEVROLET MONTE CARLO 3.8L  
 1984-82 4 CHEVROLET S-Series (2WD), T-Series (4WD) PICKUP 1.9L  
 1984-83 4 CHEVROLET S-Series (2WD), T-Series (4WD) PICKUP 2.0L  
 1987-82 6 CHEVROLET S-Series (2WD), T-Series (4WD) PICKUP 2.8L  
 1993-85 4 CHEVROLET S-Series (2WD), T-Series (4WD) PICKUP 2.5L  
 1980 6 GMC CABALLERO/SPRINT 3.8L  
 1987-83 6 GMC S-15 JIMMY 2.8L  
 1988-83 4 GMC S-15 JIMMY All  
 1984-82 4 GMC S-Series (2WD), T-Series (4WD) PICKUP (SONOMA) 1.9L  
 1984-83 4 GMC S-Series (2WD), T-Series (4WD) PICKUP (SONOMA) 2.0L  
 1993-85 4 GMC S-Series (2WD), T-Series (4WD) PICKUP (SONOMA) 2.5L  
 1987-82 6 GMC S-Series (2WD), T-Series (4WD) PICKUP (SONOMA) 2.8L

# DIRECT FIT

## 4021

Inlet A: LOOSE 3-BOLT FLANGE W/ 45 DEGREE FLARE  
 Outlet A: 2.13" O.D. PIPE  
 Length: 26.25"



- 1992-85 4 VOLVO 740 2.3L
- 1990-87 6 VOLVO 780 2.8L
- 1995-91 4 VOLVO 940 2.3L

## 4025

Inlet A: WELDED 1.75" 2-BOLT FLANGE  
 Inlet B: WELDED 1.75" 2-BOLT FLANGE  
 Outlet A: WELDED 2-BOLT FLANGE W/ GASKET STUB  
 Length: 48"



- 1989-85 4 SUBARU HATCHBACK 1.8L
- 1994-90 4 SUBARU LOYALE 1.8L
- 1989-85 4 SUBARU SEDAN - 4 Dr. 1.8L
- 1989-85 4 SUBARU STATION WAGON 1.8L
- 1990-85 4 SUBARU XT 1.8L

## 4029

Inlet A: LOOSE 4-BOLT FLANGE W/ FLAT FLARE  
 Outlet A: 2.25" O.D. PIPE  
 Length: 22"



- 1992-90 6 DODGE MONACO 3.0L
- 1989-88 4 EAGLE PREMIER 2.5L
- 1992-88 6 EAGLE PREMIER 3.0L
- 1992-86 4 JEEP CHEROKEE 2.5L
- 1992-87 6 JEEP CHEROKEE 4.0L
- 1986 4 JEEP COMANCHE 2.5L
- 1992-87 4,6 JEEP COMANCHE All
- 1987-86 4 JEEP WAGONEER 2.5L
- 1990-87 6 JEEP WAGONEER 4.0L
- 1992-87 4 JEEP WRANGLER 2.5L
- 1992-91 6 JEEP WRANGLER 4.0L

## 4032

Inlet A: WELDED 4-BOLT FLANGE  
 Outlet A: 2.165" O.D. PIPE  
 Length: 34.50"



- 1993-90 4 VOLKSWAGEN CABRIOLET 1.8L

## 4036

Inlet A: WELDED 3-BOLT FLANGE  
 Outlet A: WELDED 3-BOLT FLANGE  
 Length: 35.50"



- 1994-92 6 AUDI 100 2.8L

## 4037

Inlet A: WELDED 3-BOLT FLANGE  
 Inlet B: LOOSE 3-BOLT FLANGE W/ 45 DEGREE FLARE  
 Outlet A: LOOSE 3-BOLT FLANGE W/ 45 DEGREE FLARE  
 Length: 48.63"



- 1994-92 6 AUDI 100 2.8L

## 4038

Inlet A: WELDED 5-BOLT FLANGE  
 Outlet A: WELDED 2-BOLT FLANGE  
 Length: 35"



- 1997-96 4 FORD PROBE 2.0L
- 1997-96 4 MAZDA 626 2.0L
- 1997-96 4 MAZDA MX6 2.0L

### 4043

Inlet A: SPHERICAL FLARE  
 Outlet A: WELDED 2-BOLT FLANGE  
 Length: 95.25"

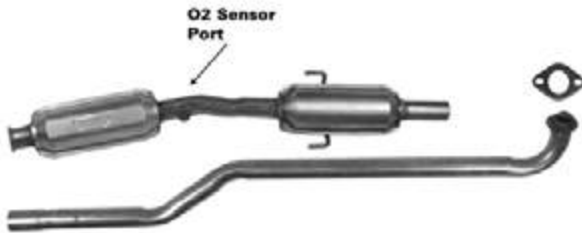

2002-98 4 CHEVROLET PRIZM 1.8L  
 2002-98 4 TOYOTA COROLLA 1.8L

### 4044

Inlet A: LOOSE 2-BOLT FLANGE W/ FEMALE FLARE  
 Outlet A: 2.25" O.D. PIPE  
 Length: 45.50"



2001-97 6 FORD EXPLORER 4.0L  
 2001-98 6 MERCURY MOUNTAINEER 4.0L

### 4044A

Inlet A: LOOSE 2-BOLT FLANGE W/ SPHERICAL FLARE  
 Outlet A: 2.25" O.D. PIPE  
 Outlet B: LOOSE 2-BOLT FLANGE W/ MALE BALL  
 Length: 46"



2001-97 6 FORD EXPLORER 4.0L  
 2001-98 6 MERCURY MOUNTAINEER 4.0L

### 4045

Inlet A: LOOSE 2-BOLT FLANGE W/ FEMALE FLARE  
 Outlet A: WELDED 2-BOLT FLANGE  
 Length: 27.50"



2001-97 6 FORD EXPLORER 4.0L  
 2001-98 6 MERCURY MOUNTAINEER 4.0L

### 4046

Inlet A: LOOSE 3-BOLT FLANGE W/ FLAT FLARE  
 Outlet A: 2" O.D. PIPE  
 Length: 36.25"



1993-84 4 VOLVO 240 2.3L

### 4049

Inlet A: LOOSE 2-BOLT FLANGE W/ CHRYSLER FLARE  
 Outlet A: 2.25" O.D. PIPE  
 Length: 41.25"



1993-92 6 CHRYSLER TOWN & COUNTRY 3.3L  
 1995-94 6 CHRYSLER TOWN & COUNTRY 3.8L  
 1995-92 6 DODGE CARAVAN 3.0L  
 1995-94 6 DODGE CARAVAN 3.3L  
 1995-94 6 DODGE CARAVAN 3.8L  
 1995-92 6 PLYMOUTH VOYAGER 3.0L  
 1995-94 6 PLYMOUTH VOYAGER 3.3L  
 1995-94 6 PLYMOUTH VOYAGER 3.8L

### 4051

Inlet A: LOOSE 2-BOLT CHRYSLER FLANGE W/ CHRYSLER FLARE  
 Outlet A: 1.88" O.D. PIPE  
 Length: 35.25"



1993-89 4 CHRYSLER DAYTONA 2.5L  
 1993-88 4 CHRYSLER DYNASTY 2.5L  
 1986-84 4 CHRYSLER LASER AII  
 1989 4 CHRYSLER LEBARON 2.2L  
 1993-89 4 CHRYSLER LEBARON 2.5L  
 1984 4 DODGE DAYTONA 2.2L  
 1986-85 4 DODGE DAYTONA AII  
 1993-87 4 DODGE DAYTONA 2.5L  
 1993-88 4 DODGE DYNASTY 2.5L  
 1989-88 4 DODGE LANCER 2.2L  
 1989-88 4 DODGE LANCER 2.5L  
 1994-87 4 DODGE SHADOW 2.2L  
 1994-89 4 DODGE SHADOW 2.5L  
 1995-89 4 DODGE SPIRIT 2.5L  
 1995-89 4 PLYMOUTH ACCLAIM 2.5L  
 1994-87 4 PLYMOUTH SUNDANCE, DUSTER 2.2L  
 1994-89 4 PLYMOUTH SUNDANCE, DUSTER 2.5L

# DIRECT FIT

## 4052

Inlet A: LOOSE 2-BOLT FLANGE W/ FEMALE FLARE  
 Inlet B: LOOSE 2-BOLT FLANGE W/ FEMALE FLARE  
 Outlet A: WELDED 2-BOLT FLANGE  
 Length: 43"

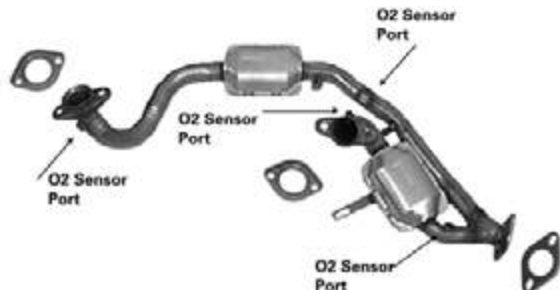

- 1999-96 6 FORD TAURUS 3.0L
- 1999-96 6 MERCURY SABLE 3.0L

## 4054

Inlet A: WELDED 2-BOLT FLANGE  
 Outlet A: WELDED 2-BOLT FLANGE  
 Length: 26"

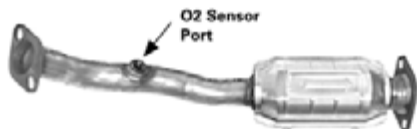

- 1997-96 6 MAZDA MPV VAN 3.0L

## 4055

Inlet A: LOOSE 2-BOLT FLANGE W/ SPHERICAL FLARE  
 Inlet B: LOOSE 2-BOLT FLANGE W/ SPHERICAL FLARE  
 Outlet A: WELDED 2-BOLT FLANGE  
 Length: 45"



- 2000-98 6 FORD WINDSTAR 3.8L

## 4056

Inlet A: WELDED 2-BOLT FLANGE W/ GASKET STUB  
 Outlet A: WELDED 2-BOLT FLANGE W/ GASKET STUB  
 Length: 40.50"



- 2002-96 6 MAZDA MILLENIA 2.3L

## 4058

Inlet A: WELDED 4-BOLT FLANGE  
 Inlet B: WELDED 4-BOLT FLANGE  
 Outlet A: WELDED 3-BOLT FLANGE  
 Length: 18"

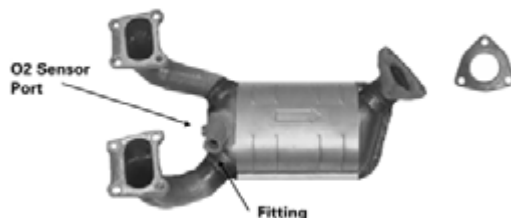

- 1998-95 4 NISSAN 200SX 1.6L
- 1999-95 4 NISSAN SENTRA 1.6L

## 4061

Inlet A: WELDED 3-BOLT FLANGE W/ GASKET STUB  
 Outlet A: WELDED 2-BOLT FLANGE W/ GASKET STUB  
 Length: 50.50"



- 2001-97 4 TOYOTA CAMRY, (Inc. 1998 & Older SOLARA) 2.2L
- 2001-99 4 TOYOTA SOLARA 2.2L

## 4063

Inlet A: WELDED 2-BOLT FLANGE  
 Outlet A: WELDED 2-BOLT FLANGE  
 Length: 68.25"



- 2002-99 4 MAZDA MIATA, MX5 1.8L

### 4064

Inlet A: WELDED 2-BOLT FLANGE  
 Outlet A: WELDED 2-BOLT FLANGE  
 Length: 14.25"



1998 4 SUBARU FORESTER 2.5L

### 4068

Inlet A: WELDED 3-BOLT FLANGE  
 Outlet A: WELDED 3-BOLT FLANGE  
 Length: 42.75"



1995-93 4 SATURN SC1 1.9L  
 1995-93 4 SATURN SL / SL1 1.9L  
 1995-93 4 SATURN SW1 1.9L

### 4070

Inlet A: LOOSE 2-BOLT FLANGE W/ 2" FLAT FLARE  
 Outlet A: LOOSE 2-BOLT FLANGE W/ 2" FLAT FLARE  
 Length: 16.50"



1988-85 4 CHEVROLET NOVA 1.6L  
 1989-83 4 TOYOTA COROLLA All

### 4073

Inlet A: LOOSE 2-BOLT FLANGE W/ FEMALE FLARE  
 Inlet B: LOOSE 2-BOLT FLANGE W/ FEMALE FLARE  
 Outlet A: WELDED 2-BOLT FLANGE W/ GASKET STUB  
 Length: 27"

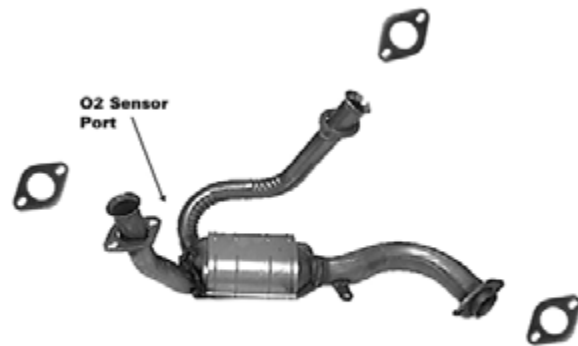

1993-86 6 FORD TAURUS 3.0L  
 1994-86 6 MERCURY SABLE 3.0L

### 4076

Inlet A: LOOSE 2-BOLT FLANGE W/ FEMALE FLARE  
 Outlet A: WELDED 4-BOLT FLANGE  
 Length: 65.25"



1992-86 4 BUICK CENTURY 2.5L  
 1990-86 4 CHEVROLET CELEBRITY 2.5L  
 1992-86 4 OLDSMOBILE CIERA 2.5L  
 1991-86 4 PONTIAC 6000 2.5L

### 4078

Inlet A: WELDED 4-BOLT FLANGE  
 Outlet A: LOOSE 2-BOLT FLANGE W/ SPECIAL BALL  
 Length: 56"

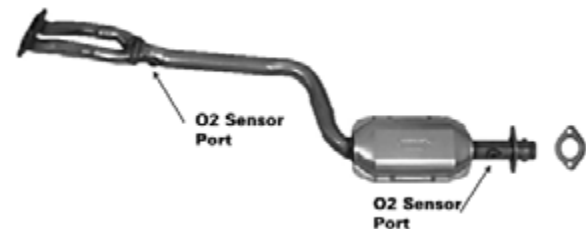

1998-96 4 BMW 318 1.9L

## DIRECT FIT

### 4087

Inlet A: LOOSE 2-BOLT FLANGE W/ 2.50" FLAT FLARE  
 Outlet A: LOOSE 2-BOLT FLANGE W/ 2.50" FLAT FLARE  
 Length: 12.50"



- 1994-92 6 LEXUS ES300 3.0L
- 1992-89 4 NISSAN 240SX All
- 1995-88 4 NISSAN PICKUP 2.4L
- 1993-92 4 TOYOTA CAMRY, (Inc. 1998 & Older SOLARA) 2.2L
- 1994-92 6 TOYOTA CAMRY, (Inc. 1998 & Older SOLARA) 3.0L
- 1989-86 4 TOYOTA CELICA 2.0L
- 1993-90 4 TOYOTA CELICA 1.6L
- 1992-89 6 TOYOTA CRESSIDA 3.0L
- 1995-89 4 TOYOTA PICKUP (ALL MODELS Exc. TACOMA & TUNDRA) 2.4L
- 1992-86 6 TOYOTA SUPRA 3.0L
- 1989-88 4 TOYOTA VAN 2.2L

### 4088

Inlet A: 2.50" I.D. PIPE  
 Outlet A: WELDED 4-BOLT GM FLANGE W/ 2.50" MALE BALL  
 Length: 21.38"



- 1991-88 6 CHEVROLET BLAZER S-Series All
- 1994-92 6 CHEVROLET BLAZER S-Series 4.3L
- 1993-88 6 CHEVROLET S-Series (2WD), T-Series (4WD) PICKUP 2.8L
- 1994-88 6 CHEVROLET S-Series (2WD), T-Series (4WD) PICKUP 4.3L
- 1991-88 6 GMC S-15 JIMMY All
- 1994-92 6 GMC S-15 JIMMY 4.3L
- 1993-88 6 GMC S-Series (2WD), T-Series (4WD) PICKUP (SONOMA) 2.8L
- 1994-88 6 GMC S-Series (2WD), T-Series (4WD) PICKUP (SONOMA) 4.3L
- 1992-91 6 OLDSMOBILE BRAVADA 4.3L

### 4089

Inlet A: LOOSE 3-BOLT FLANGE W/ 45 DEGREE FLARE  
 Outlet A: WELDED 2-BOLT FLANGE  
 Length: 32"



- 1998-96 4 SAAB 9000 2.3L

### 4094

Inlet A: WELDED 4-BOLT FLANGE  
 Outlet A: 2.25" O.D. PIPE  
 Length: 33.13"



- 2004-00 4 DODGE NEON All
- 2001-00 4 PLYMOUTH NEON 2.0L

### 4094G

Inlet A: WELDED 4-BOLT FLANGE  
 Outlet A: 2" O.D. PIPE  
 Length: 33.25"



- 2001-00 4 DODGE NEON 2.0L
- 2001-00 4 PLYMOUTH NEON 2.0L

### 4096

Inlet A: WELDED 2-BOLT FLANGE  
 Outlet A: WELDED 2-BOLT FLANGE W/ GASKET STUB  
 Length: 51.13"



- 2000-98 3 CHEVROLET METRO 1.0L
- 2000-98 4 CHEVROLET METRO 1.3L
- 1997-96 3 GEO METRO 1.0L
- 1997-96 4 GEO METRO 1.3L



### 4107

Inlet A: WELDED 4-BOLT FLANGE  
 Outlet A: WELDED 3-BOLT FLANGE W/ GASKET STUB  
 Length: 40.13"



1998-96	4	CHEVROLET CAVALIER 2.4L
1998-97	4	CHEVROLET MALIBU 2.4L
1999	4	PONTIAC GRAND AM 2.4L
1998-96	4	PONTIAC SUNFIRE 2.4L

### 4110

Inlet A: LOOSE 2-BOLT FLANGE W/ FEMALE FLARE  
 Inlet B: LOOSE 2-BOLT FLANGE W/ FEMALE FLARE  
 Outlet A: 2.25" O.D. PIPE  
 Length: 50.63"

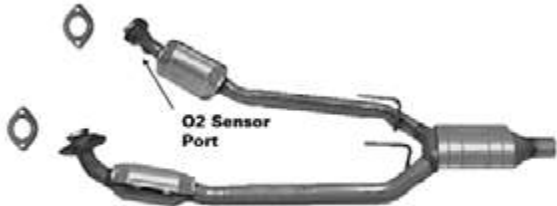

1993-91	8	FORD THUNDERBIRD 5.0L
1993-91	8	MERCURY COUGAR 5.0L

### 4111

Inlet A: 2.25" I.D. PIPE  
 Outlet A: LOOSE 4-BOLT GM FLANGE W/ 2.25" MALE BALL  
 Length: 22"



1978	8	BUICK CENTURY 5.0L
1979-78	6	BUICK CENTURY All
1981	6	BUICK CENTURY 3.8L
1981	8	BUICK CENTURY 4.3L
1983-81	6	BUICK ELECTRA - (Inc. Park Avenue) 4.1L
1983-81	8	BUICK ELECTRA - (Inc. Park Avenue) 5.0L
1982-81	6	BUICK LESABRE All
1983-81	8	BUICK LESABRE 5.0L
1979-78	6	BUICK REGAL 3.8L
1982-80	8	BUICK REGAL All
1982-81	6	BUICK REGAL All
1983-81	6	BUICK RIVIERA 4.1L
1983-81	8	BUICK RIVIERA 5.0L
1982-81	6	CADILLAC DEVILLE 4.1L
1983-82	8	CADILLAC DEVILLE 4.1L
1982-81	6	CADILLAC ELDORADO 4.1L

### 4111 (cont.)

1983-82	8	CADILLAC ELDORADO 4.1L
1982-81	6	CADILLAC FLEETWOOD 4.1L
1983-82	8	CADILLAC FLEETWOOD 4.1L
1982-81	6	CADILLAC SEVILLE 4.1L
1983-82	8	CADILLAC SEVILLE 4.1L
1980	8	CHEVROLET CAMARO 4.4L
1981	6	CHEVROLET CAMARO 3.8L
1981	8	CHEVROLET CAMARO All
1978	8	CHEVROLET EL CAMINO 5.0L
1979-78	6	CHEVROLET EL CAMINO All
1979	8	CHEVROLET EL CAMINO 4.4L
1982-81	8	CHEVROLET EL CAMINO All
1983-80	6	CHEVROLET EL CAMINO 3.8L
1983	6	CHEVROLET FULL SIZE (Inc. Impala RWD, Caprice, Belair, Police, Taxi, Station Wagon) 3.8L
1982-81	8	CHEVROLET FULL SIZE (Inc. Impala RWD, Caprice, Belair, Police, Taxi, Station Wagon) All
1979-78	6	CHEVROLET MALIBU All
1979	8	CHEVROLET MALIBU 4.4L
1982-81	8	CHEVROLET MALIBU All
1983-80	6	CHEVROLET MALIBU 3.8L
1978	8	CHEVROLET MONTE CARLO 5.0L
1979	8	CHEVROLET MONTE CARLO 4.4L
1982-81	8	CHEVROLET MONTE CARLO All
1983-80	6	CHEVROLET MONTE CARLO 3.8L
1978	8	GMC CABALLERO/SPRINT 5.0L
1979-78	6	GMC CABALLERO/SPRINT All
1979	8	GMC CABALLERO/SPRINT 4.4L
1982-81	8	GMC CABALLERO/SPRINT All
1983-80	6	GMC CABALLERO/SPRINT 3.8L
1983-81	6	OLDSMOBILE 98 4.1L
1983-81	8	OLDSMOBILE 98 5.0L
1982-78	8	OLDSMOBILE CUTLASS 4.3L
1982-81	8	OLDSMOBILE CUTLASS 5.0L
1983-78	6	OLDSMOBILE CUTLASS 3.8L
1982-81	6	OLDSMOBILE EIGHTY-EIGHT, DELTA 88 All
1983-81	8	OLDSMOBILE EIGHTY-EIGHT, DELTA 88 5.0L
1983-81	6	OLDSMOBILE TORONADO 4.1L
1983-81	8	OLDSMOBILE TORONADO 5.0L
1983-81	8	PONTIAC BONNEVILLE All
1983	6	PONTIAC BONNEVILLE 3.8L
1981	6	PONTIAC CATALINA All
1981	8	PONTIAC CATALINA All
1981	6	PONTIAC FIREBIRD, TRANS AM, FORMULA 3.8L
1981	8	PONTIAC FIREBIRD, TRANS AM, FORMULA 4.3L
1981	8	PONTIAC FIREBIRD, TRANS AM, FORMULA 4.9L
1981	8	PONTIAC FIREBIRD, TRANS AM, FORMULA 5.0L
1978	8	PONTIAC GRAND AM 5.0L
1979-78	8	PONTIAC GRAND PRIX 4.9L
1982	6	PONTIAC GRAND PRIX All
1983-81	6	PONTIAC GRAND PRIX 3.8L
1983-81	8	PONTIAC GRAND PRIX All
1978	8	PONTIAC LE MANS 5.0L
1981	6	PONTIAC LE MANS 3.8L
1981	8	PONTIAC LE MANS 4.3L

# DIRECT FIT

## 4112

**Inlet A: LOOSE 4-BOLT FLANGE W/ 2.25" FLAT FLARE**  
**Outlet A: LOOSE 4-BOLT GM FLANGE W/ 2.25" MALE BALL**  
**Length: 21"**



- |         |   |  |
|---------|---|--|
| 1984    | 6 | BUICK ELECTRA - (Inc. Park Avenue) 4.1L  |
| 1985-83 | 6 | BUICK LESABRE All  |
| 1984-83 | 6 | BUICK REGAL 4.1L   |
| 1987-83 | 6 | BUICK REGAL 3.8L   |
| 1987-86 | 8 | BUICK REGAL 5.0L   |
| 1984    | 6 | BUICK RIVIERA 4.1L   |
| 1985-81 | 6 | BUICK RIVIERA 3.8L   |
| 1984    | 6 | CHEVROLET EL CAMINO 3.8L   |
| 1984-83 | 6 | CHEVROLET FULL SIZE (Inc. Impala RWD, Caprice, Belair, Police, Taxi, Station Wagon) 3.8L |
| 1984-81 | 6 | CHEVROLET MONTE CARLO 3.8L   |
| 1984    | 6 | GMC CABALLERO/SPRINT 3.8L  |
| 1987-83 | 6 | OLDSMOBILE CUTLASS 3.8L  |
| 1988-83 | 8 | OLDSMOBILE CUTLASS 5.0L  |
| 1984-83 | 6 | OLDSMOBILE EIGHTY-EIGHT, DELTA 88 All  |
| 1984    | 6 | OLDSMOBILE TORONADO 4.1L   |
| 1986-83 | 6 | PONTIAC BONNEVILLE 3.8L  |
| 1987-83 | 6 | PONTIAC GRAND PRIX 3.8L  |
| 1985-84 | 6 | PONTIAC PARISIENNE 3.8L  |

## 4113

**Inlet A: LOOSE 2-BOLT FLANGE W/ 2" FEMALE FLARE**  
**Outlet A: LOOSE 2-BOLT FLANGE W/ FLAT FLARE**  
**Length: 24"**



- |         |   |                     |
|---------|---|---------------------|
| 1995-91 | 4 | FORD ESCORT 1.9L    |
| 1995-91 | 4 | MERCURY TRACER 1.9L |

## 4114

**Inlet A: WELDED 3-BOLT FLANGE**  
**Outlet A: 2.165" O.D. PIPE**  
**Length: 19.75"**



- |         |   |                           |
|---------|---|---------------------------|
| 2002-96 | 4 | VOLKSWAGEN CABRIOLET 2.0L |
| 1998-96 | 4 | VOLKSWAGEN GOLF 2.0L      |
| 1998-96 | 4 | VOLKSWAGEN JETTA 2.0L     |
| 1996    | 4 | VOLKSWAGEN PASSAT 2.0L    |

## 4115

**Inlet A: 2.25" I.D. PIPE**  
**Outlet A: LOOSE 4-BOLT GM FLANGE W/ 2.50" MALE BALL**  
**Length: 23"**



- |         |   |  |
|---------|---|--|
| 1985-83 | 8 | BUICK REGAL 5.0L   |
| 1991    | 8 | BUICK ROADMASTER 5.0L  |
| 1993-92 | 8 | BUICK ROADMASTER 5.7L  |
| 1992-82 | 8 | CHEVROLET CAMARO All   |
| 1992-83 | 6 | CHEVROLET CAMARO All   |
| 1984-83 | 6 | CHEVROLET EL CAMINO 3.8L   |
| 1987-83 | 8 | CHEVROLET EL CAMINO All  |
| 1984-83 | 6 | CHEVROLET FULL SIZE (Inc. Impala RWD, Caprice, Belair, Police, Taxi, Station Wagon) 3.8L |
| 1993-92 | 6 | CHEVROLET FULL SIZE (Inc. Impala RWD, Caprice, Belair, Police, Taxi, Station Wagon) 4.3L |
| 1993-83 | 8 | CHEVROLET FULL SIZE (Inc. Impala RWD, Caprice, Belair, Police, Taxi, Station Wagon) 5.0L |
| 1990-83 | 8 | CHEVROLET FULL SIZE (Inc. Impala RWD, Caprice, Belair, Police, Taxi, Station Wagon) 5.7L |
| 1983    | 6 | CHEVROLET MALIBU 3.8L  |
| 1983    | 8 | CHEVROLET MALIBU 5.0L  |
| 1984-83 | 6 | CHEVROLET MONTE CARLO 3.8L   |
| 1988-83 | 8 | CHEVROLET MONTE CARLO All  |
| 1984-83 | 6 | GMC CABALLERO/SPRINT 3.8L  |
| 1987-83 | 8 | GMC CABALLERO/SPRINT All   |
| 1986-84 | 8 | PONTIAC BONNEVILLE 5.0L  |
| 1992-82 | 8 | PONTIAC FIREBIRD, TRANS AM, FORMULA 5.0L   |
| 1992-83 | 6 | PONTIAC FIREBIRD, TRANS AM, FORMULA All  |
| 1987-84 | 8 | PONTIAC GRAND PRIX 5.0L  |
| 1986-85 | 8 | PONTIAC PARISIENNE 5.0L  |

### 4116

Inlet A: WELDED 4-BOLT FLANGE  
 Outlet A: WELDED 4-BOLT FLANGE  
 Length: 16.13"



- 1985-83 8 CHEVROLET CAMARO 5.0L
- 1988-83 8 CHEVROLET MONTE CARLO 5.0L
- 1985-83 8 PONTIAC FIREBIRD, TRANS AM, FORMULA 5.0L

### 4117

Inlet A: 2" O.D. PIPE  
 Outlet A: 2" O.D. PIPE  
 Length: 27"



- 1989-87 4 BUICK SKYHAWK 2.0L
- 1989-86 4 BUICK SKYLARK 2.5L
- 1989-86 6 BUICK SKYLARK All
- 1987-85 4,6 BUICK SOMERSET - SOMERSET REGAL All
- 1988-87 6 CADILLAC CIMARRON 2.8L
- 1993 6 CHEVROLET BERETTA 3.1L
- 1989-87 4 CHEVROLET CAVALIER 2.0L
- 1989-87 6 CHEVROLET CAVALIER 2.8L
- 1994-90 6 CHEVROLET CAVALIER 3.1L
- 1993 6 CHEVROLET CORSICA 3.1L
- 1981 8 JEEP CJ 5.0L
- 1988-85 6 OLDSMOBILE CALAIS 3.0L
- 1989-85 4 OLDSMOBILE CALAIS 2.5L
- 1987 6 OLDSMOBILE FIRENZA 2.8L
- 1987-85 6 PONTIAC GRAND AM 3.0L
- 1989-85 4 PONTIAC GRAND AM 2.5L
- 1989 4 PONTIAC SUNBIRD 2.0L
- 1994-91 6 PONTIAC SUNBIRD 3.1L

### 4118

Inlet A: LOOSE 2-BOLT FLANGE, W/ 2" FEMALE FLARE  
 Inlet B: LOOSE 2-BOLT FLANGE, W/ 2" FEMALE FLARE  
 Outlet A: WELDED 2-BOLT FLANGE  
 Length: 41.50"



- 1995-91 6 FORD TAURUS 3.8L

### 4118 (cont.)

- 1994-90 6 LINCOLN CONTINENTAL 3.8L
- 1995-91 6 MERCURY SABLE 3.8L

### 4119

Inlet A: 2.25" I.D. PIPE  
 Outlet A: LOOSE 4-BOLT GM FLANGE W/ 2.25" MALE BALL  
 Length: 23"



- 1989-84 8 BUICK ELECTRA - (Inc. Park Avenue) 5.0L
- 1990-84 8 BUICK LESABRE 5.0L
- 1985-84 8 BUICK RIVIERA 5.0L
- 1984 8 CADILLAC DEVILLE 4.1L
- 1980 8 CHEVROLET CAMARO 4.4L
- 1984 8 OLDSMOBILE 98 5.0L
- 1990-84 8 OLDSMOBILE EIGHTY-EIGHT, DELTA 88 5.0L
- 1985-84 8 OLDSMOBILE TORONADO 5.0L
- 1986 8 PONTIAC PARISIENNE 5.0L
- 1989-87 8 PONTIAC SAFARI STATION WAGON 5.0L

### 4120

Inlet A: LOOSE 2-BOLT FLANGE W/ 2.25" FEMALE FLARE  
 Outlet A: 2.25" O.D. PIPE  
 Length: 37.25"



- 1990-88 6 BUICK ELECTRA - (Inc. Park Avenue) 3.8L
- 1991-88 6 BUICK LESABRE 3.8L
- 1987-86 6 BUICK RIVIERA 3.8L
- 1987-86 8 CADILLAC COMMERCIAL CHASSIS - FUNERAL COACH, LIMOUSINE 4.1L
- 1987-86 8 CADILLAC DEVILLE 4.1L
- 1987-86 8 CADILLAC FLEETWOOD 4.1L
- 1990-88 6 OLDSMOBILE 98 3.8L
- 1991-88 6 OLDSMOBILE EIGHTY-EIGHT, DELTA 88 3.8L
- 1987-86 6 OLDSMOBILE TORONADO 3.8L
- 1991-88 6 PONTIAC BONNEVILLE 3.8L

# DIRECT FIT

## 4120G

Inlet A: LOOSE 2-BOLT FLANGE W/ 2.25" FEMALE FLARE  
 Outlet A: 2.38" O.D. PIPE  
 Length: 36.75"



- 1990-88 6 BUICK ELECTRA - (Inc. Park Avenue) 3.8L
- 1991-88 6 BUICK LESABRE 3.8L
- 1987-86 6 BUICK RIVIERA 3.8L
- 1987-86 8 CADILLAC COMMERCIAL CHASSIS - FUNERAL COACH, LIMOUSINE 4.1L
- 1987-86 8 CADILLAC DEVILLE 4.1L
- 1987-86 8 CADILLAC FLEETWOOD 4.1L
- 1990-88 6 OLDSMOBILE 98 3.8L
- 1991-88 6 OLDSMOBILE EIGHTY-EIGHT, DELTA 88 3.8L
- 1987-86 6 OLDSMOBILE TORONADO 3.8L
- 1991-88 6 PONTIAC BONNEVILLE 3.8L

## 4122

Inlet A: LOOSE 2-BOLT FLANGE W/ 2.25" FEMALE FLARE  
 Outlet A: 2" O.D. PIPE  
 Length: 25.75"



- 1990-86 4 FORD ESCORT 1.9L
- 1994-85 4 FORD TEMPO 2.3L
- 1987-86 4 MERCURY LYNX 1.9L
- 1994-85 4 MERCURY TOPAZ 2.3L

## 4128

Inlet A: LOOSE 2-BOLT FLANGE W/ GASKET STUB  
 Outlet A: 2.25" O.D. PIPE  
 Length: 41"



- 1997-96 4 DODGE STRATUS 2.0L
- 1997-96 4 PLYMOUTH BREEZE 2.0L

## 4130

Inlet A: LOOSE 2-BOLT FLANGE W/ FEMALE FLARE  
 Outlet A: WELDED 3-BOLT FLANGE  
 Length: 32.50"

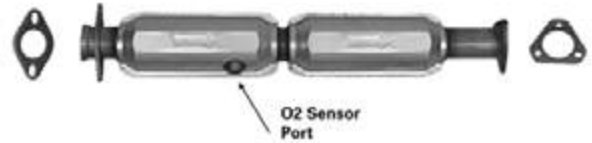

- 2004-96 6 ACURA RL 3.5L
- 1998-96 6 ACURA TL 3.2L

## 4133

Inlet A: WELDED 2-BOLT FLANGE  
 Outlet A: WELDED 2-BOLT FLANGE  
 Length: 64.25"

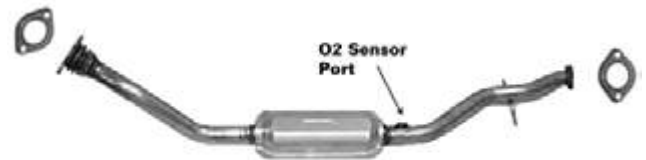

- 2000-97 6 CHEVROLET VENTURE 3.4L
- 2000-97 6 OLDSMOBILE SILHOUETTE 3.4L
- 2000-99 6 PONTIAC MONTANA 3.4L
- 1998-97 6 PONTIAC TRANS SPORT 3.4L

## 4137

Inlet A: 2.25" O.D. PIPE  
 Outlet A: 2" O.D. PIPE  
 Length: 34.75"



- 1989-88 6 BUICK REGAL 2.8L
- 1993-89 6 BUICK REGAL 3.1L
- 1992-90 4 CHEVROLET LUMINA 2.5L
- 1993-90 6 CHEVROLET LUMINA 3.1L
- 1989-88 6 OLDSMOBILE CUTLASS 2.8L
- 1991-90 4 OLDSMOBILE CUTLASS 2.3L
- 1993-89 6 OLDSMOBILE CUTLASS 3.1L
- 1989-88 6 PONTIAC GRAND PRIX 2.8L
- 1991-90 4 PONTIAC GRAND PRIX 2.3L
- 1993-89 6 PONTIAC GRAND PRIX 3.1L

### 4137G

Inlet A: 2.25" O.D. PIPE  
 Outlet A: 2.13" O.D. PIPE  
 Length: 34.75"



- |         |   |                         |
|---------|---|-------------------------|
| 1989-88 | 6 | BUICK REGAL 2.8L        |
| 1993-89 | 6 | BUICK REGAL 3.1L        |
| 1992-90 | 4 | CHEVROLET LUMINA 2.5L   |
| 1993-90 | 6 | CHEVROLET LUMINA 3.1L   |
| 1989-88 | 6 | OLDSMOBILE CUTLASS 2.8L |
| 1991-90 | 4 | OLDSMOBILE CUTLASS 2.3L |
| 1993-89 | 6 | OLDSMOBILE CUTLASS 3.1L |
| 1989-88 | 6 | PONTIAC GRAND PRIX 2.8L |
| 1991-90 | 4 | PONTIAC GRAND PRIX 2.3L |
| 1993-89 | 6 | PONTIAC GRAND PRIX 3.1L |

### 4140

Inlet A: WELDED 4-BOLT FLANGE  
 Outlet A: WELDED 2-BOLT FLANGE  
 Length: 40.38"



- |         |   |                       |
|---------|---|-----------------------|
| 2000-98 | 4 | FORD CONTOUR 2.0L     |
| 2002-99 | 4 | MERCURY COUGAR 2.0L   |
| 2000-98 | 4 | MERCURY MYSTIQUE 2.0L |

### 4141

Inlet A: LOOSE 2-BOLT FLANGE W/ FEMALE FLARE  
 Outlet A: WELDED 4-BOLT FLANGE  
 Length: 45.25"



- |         |   |                         |
|---------|---|-------------------------|
| 1994    | 6 | CHEVROLET LUMINA 3.1L   |
| 1993-90 | 6 | OLDSMOBILE CUTLASS 3.1L |
| 1993-90 | 6 | PONTIAC GRAND PRIX 3.1L |

### 4142

Inlet A: WELDED 4-BOLT FLANGE W/ STUDS  
 Outlet A: LOOSE 2-BOLT FLANGE W/ FEMALE FLARE  
 Length: 12.50"



- |         |   |                       |
|---------|---|-----------------------|
| 2006-01 | 6 | CHRYSLER SEBRING 2.7L |
| 2006-01 | 6 | DODGE STRATUS 2.7L    |

### 4143

Inlet A: WELDED 4-BOLT FLANGE W/ STUDS  
 Outlet A: WELDED 2-BOLT FLANGE  
 Length: 8.25"



- |         |   |                       |
|---------|---|-----------------------|
| 2006-01 | 6 | CHRYSLER SEBRING 2.7L |
| 2006-01 | 6 | DODGE STRATUS 2.7L    |

### 4145

Inlet A: WELDED 3-BOLT FLANGE  
 Outlet A: WELDED 3-BOLT FLANGE  
 Length: 15.50"



- |         |   |                   |
|---------|---|-------------------|
| 2002-98 | 4 | HONDA ACCORD 2.3L |
|---------|---|-------------------|

# DIRECT FIT

## 4147

Inlet A: WELDED 3-BOLT FLANGE W/ STUDS  
 Outlet A: WELDED 2-BOLT FLANGE  
 Length: 21.25"

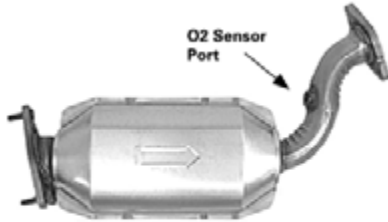

- 2000-95 6 FORD CONTOUR 2.5L
- 2000-99 6 MERCURY COUGAR 2.5L
- 2000-95 6 MERCURY MYSTIQUE 2.5L

## 4152

Inlet A: LOOSE 2-BOLT FLANGE W/ FEMALE FLARE  
 Inlet B: LOOSE 2-BOLT FLANGE W/ FEMALE FLARE  
 Outlet A: 2.25" O.D. PIPE  
 Length: 51.50"



- 1997-96 8 FORD THUNDERBIRD 4.6L
- 1997-96 8 MERCURY COUGAR 4.6L

## 4155

Inlet A: 2" I.D. PIPE  
 Outlet A: WELDED 4-BOLT GM FLANGE  
 Length: 22.25"



- 1988-86 6 BUICK CENTURY 3.8L
- 1989-84 6 BUICK CENTURY 2.8L
- 1992-86 4 BUICK CENTURY 2.5L
- 1990-86 4 CHEVROLET CELEBRITY 2.5L
- 1990-86 6 CHEVROLET CELEBRITY All
- 1988-86 6 OLDSMOBILE CIERA 3.8L
- 1989-86 6 OLDSMOBILE CIERA 2.8L
- 1992-86 4 OLDSMOBILE CIERA 2.5L
- 1989-86 6 PONTIAC 6000 2.8L
- 1991-86 4 PONTIAC 6000 2.5L
- 1991-90 6 PONTIAC 6000 3.1L

## 4158

Inlet A: WELDED 4-BOLT FLANGE  
 Outlet A: 2.165" O.D. PIPE  
 Length: 41.88"



- 2006-00 4 AUDI TT 1.8L

## 4161

Inlet A: WELDED 2-BOLT FLANGE  
 Inlet B: WELDED 2-BOLT FLANGE  
 Outlet A: 1.88" O.D. PIPE  
 Length: 53.00"



- 2006-01 6 HYUNDAI SANTA FE 2.7L

## 4164

Inlet A: WELDED 2-BOLT FLANGE W/ GASKET STUB  
 Inlet B: WELDED 2-BOLT FLANGE W/ GASKET STUB  
 Outlet A: WELDED 2-BOLT FLANGE  
 Length: 44.88"



- 2000-95 6 CHRYSLER SEBRING 2.5L
- 2000-95 6 DODGE AVENGER 2.5L

## 4165

Inlet A: WELDED 9-BOLT FLANGE  
 Outlet A: WELDED 2-BOLT FLANGE  
 Length: 20.25"



- 1998 4 HYUNDAI ELANTRA 1.8L
- 2000-99 4 HYUNDAI ELANTRA 2.0L
- 2001-98 4 HYUNDAI TIBURON 2.0L

### 4166

Inlet A: LOOSE 2-BOLT FLANGE W/ 2.25" FEMALE FLARE  
 Inlet B: LOOSE 2-BOLT FLANGE W/ 2.25" FEMALE FLARE  
 Outlet A: LOOSE 2-BOLT FLANGE W/ 2.25" MALE BALL  
 Outlet B: LOOSE 2-BOLT FLANGE W/ 2.25" MALE BALL  
 Length: 54"



1993-86 8 FORD MUSTANG 5.0L  
 1986 8 MERCURY CAPRI 5.0L

### 4167

Inlet A: WELDED 2-BOLT FLANGE  
 Inlet B: LOOSE 3-BOLT FLANGE W/ 45 DEGREE FLARE  
 Outlet A: WELDED 2-BOLT FLANGE  
 Length: 54.50"



2003-99 6 SAAB 9-5 3.0L

### 4168

Inlet A: 3-BOLT FLANGE W/ 45 DEGREE FLARE  
 Outlet A: WELDED 2-BOLT FLANGE  
 Length: 36"



2003-00 4 SAAB 9-5 2.3L

### 4170

Inlet A: WELDED 2-BOLT FLANGE  
 Outlet A: WELDED 2-BOLT FLANGE  
 Length: 52"



1988-85 3 CHEVROLET SPRINT All  
 1994-89 3 GEO METRO All  
 1991-85 3 PONTIAC FIREFLY 1.0L  
 1994-89 4 SUZUKI SWIFT 1.3L

### 4172

Inlet A: LOOSE 3-BOLT FLANGE W/ FLAT FLARE  
 Outlet A: LOOSE 3-BOLT FLANGE W/ FLAT FLARE  
 Length: 12.50"



1987-86 4 ACURA INTEGRA 1.6L  
 1983-80 4 HONDA ACCORD 1.8L  
 1989-86 4 HONDA ACCORD 2.0L  
 1983-80 4 HONDA CIVIC 1.3L  
 1983-80 4 HONDA CIVIC 1.5L  
 1982-80 4 HONDA PRELUDE 1.8L  
 1991-88 4 HONDA PRELUDE 2.0L

### 4174

Inlet A: LOOSE 2-BOLT FLANGE W/ FEMALE FLARE  
 Outlet A: WELDED 2-BOLT FLANGE  
 Length: 36.13"



2002-98 4 CHEVROLET TRACKER 1.6L  
 2003-99 4 CHEVROLET TRACKER 2.0L  
 1997-96 4 GEO TRACKER All  
 1998-96 4 SUZUKI SIDEKICK 1.6L  
 1998-96 4 SUZUKI SIDEKICK 1.8L  
 2002-99 4 SUZUKI VITARA, GRAND VITARA 1.6L  
 2003-99 4 SUZUKI VITARA, GRAND VITARA 2.0L  
 1998-96 4 SUZUKI X90 1.6L

### 4175

Inlet A: LOOSE 4-BOLT FLANGE W/ 2.50" FLAT FLARE  
 Outlet A: LOOSE 4-BOLT FLANGE W/ 2.50" FLAT FLARE  
 Length: 22"



1988-87 4 CHEVROLET SPECTRUM 1.5L  
 1993-90 4 GEO STORM All  
 1995-94 6 HONDA PASSPORT 3.2L  
 1993-89 4 ISUZU AMIGO 2.3L  
 1994-89 4 ISUZU AMIGO 2.6L  
 1985-81 4 ISUZU I-MARK 1.8L  
 1989-85 4 ISUZU I-MARK 1.5L  
 1986-83 4 ISUZU IMPULSE 1.9L  
 1989-85 4 ISUZU IMPULSE 2.0L

# DIRECT FIT

## 4175 (cont.)

1989-88	4	ISUZU IMPULSE 2.3L
1992-90	4	ISUZU IMPULSE 1.6L
1992	4	ISUZU IMPULSE 1.8L
1987-81	4	ISUZU PICKUP All
1994-91	6	ISUZU PICKUP 3.1L
1995-86	4	ISUZU PICKUP 2.3L
1995-88	4	ISUZU PICKUP 2.6L
1992-91	6	ISUZU RODEO 3.1L
1995-91	4	ISUZU RODEO 2.6L
1995-93	6	ISUZU RODEO 3.2L
1991-89	6	ISUZU TROOPER 2.8L
1978-76	4	OPEL OPEL 1.8L
1989-85	4	PASSPORT I-MARK 1.5L
1992-90	4	PASSPORT IMPULSE 1.6L
1993-91	4	PASSPORT STYLUS 1.6L

## 4178

**Inlet A: WELDED 2-BOLT FLANGE**  
**Outlet A: LOOSE 3-BOLT FLANGE W/ FLAT FLARE**  
**Length: 15.63"**

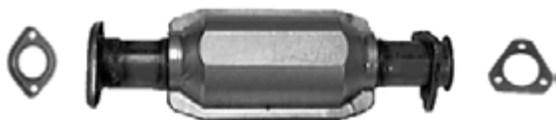

1989-88	4	ACURA INTEGRA 1.6L
1989-88	4	HONDA CIVIC All
1991-88	4	HONDA CIVIC 1.5L
1991-89	4	HONDA CIVIC 1.6L
1991-88	4	HONDA CRX 1.5L
1991-88	4	HONDA CRX 1.6L

## 4181

**Inlet A: WELDED 2-BOLT FLANGE**  
**Outlet A: WELDED 2-BOLT FLANGE W/ GASKET STUB**  
**Length: 36"**



2005	4	SAAB 9-2X 2.5L
2006-03	4	SUBARU BAJA 2.5L
2005-99	4	SUBARU FORESTER 2.5L
2005-99	4	SUBARU IMPREZA 2.5L
2005-00	4	SUBARU LEGACY 2.5L
2005-00	4	SUBARU OUTBACK 2.5L

## 4183

**Inlet A: WELDED 4-BOLT FLANGE**  
**Outlet A: 2.25" O.D. PIPE**  
**Length: 70.25"**



2000-96	6	CHRYSLER TOWN & COUNTRY 3.3L
2000-96	6	CHRYSLER TOWN & COUNTRY 3.8L
2000	6	CHRYSLER VOYAGER, GRAND VOYAGER 3.3L
2000-96	6	DODGE CARAVAN 3.3L
2000-96	6	DODGE CARAVAN 3.8L
1999-96	6	PLYMOUTH VOYAGER 3.8L
2000-96	6	PLYMOUTH VOYAGER 3.3L

## 4184

**Inlet A: WELDED 2-BOLT FLANGE**  
**Inlet B: 2-BOLT FLANGE W/ SPHERICAL FLARE**  
**Outlet A: WELDED 2-BOLT FLANGE**  
**Length: 29.75"**

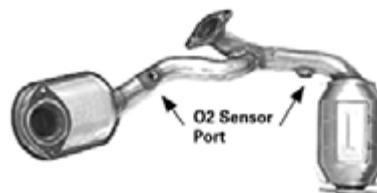

2007-00	6	FORD TAURUS 3.0L
2005-00	6	MERCURY SABLE 3.0L

## 4185

**Inlet A: WELDED 2-BOLT FLANGE**  
**Outlet A: 2.25" O.D. PIPE**  
**Length: 32.50"**



2007-00	6	FORD TAURUS 3.0L
2005-00	6	MERCURY SABLE 3.0L



### 4186

Inlet A: WELDED 3-BOLT FLANGE  
 Outlet A: WELDED 3-BOLT FLANGE  
 Length: 17"



2006-97 4 AUDI A4 1.8L  
 2005-98 4 VOLKSWAGEN PASSAT 1.8L

### 4187

Inlet A: WELDED 3-BOLT FLANGE  
 Inlet B: WELDED 3-BOLT FLANGE  
 Outlet A: 2.18" O.D. PIPE  
 Length: 45"



2002-99 6 VOLKSWAGEN GOLF 2.8L  
 2002-99 6 VOLKSWAGEN JETTA 2.8L

### 4189

Inlet A: WELDED 3-BOLT FLANGE  
 Outlet A: 2.7" MALE BALL  
 Length: 50.50"



1996-94 5 VOLVO 850 2.3L

### 4190

Inlet A: WELDED 4-BOLT FLANGE  
 Outlet A: 1.75" MALE BALL  
 Length: 44.50"



1996 5 VOLVO 850 2.3L

### 4192

Inlet A: WELDED 3-BOLT FLANGE  
 Outlet A: WELDED 2-BOLT FLANGE  
 Length: 20.50"



2008-03 V6 INFiniti FX35 3.5L  
 2007-03 6 INFiniti G35 3.5L  
 2008-06 6 INFiniti M35 3.5L  
 2006-03 6 NISSAN 350Z 3.5L

### 4193

Inlet A: WELDED 3-BOLT FLANGE  
 Outlet A: WELDED 2-BOLT FLANGE  
 Length: 22.38"



2008-03 V6 INFiniti FX35 3.5L  
 2007-03 6 INFiniti G35 3.5L  
 2008-06 6 INFiniti M35 3.5L  
 2006-03 6 NISSAN 350Z 3.5L

### 4195

Inlet A: WELDED 2-BOLT FLANGE  
 Outlet A: WELDED 2-BOLT FLANGE  
 Length: 15"



2000-97 4 MITSUBISHI MIRAGE 1.5L

### 4196

Inlet A: WELDED 2-BOLT FLANGE  
 Outlet A: WELDED 2-BOLT FLANGE  
 Length: 43"



1999 4 MITSUBISHI ECLIPSE 2.4L  
 2000-99 4 MITSUBISHI GALANT 2.4L

# DIRECT FIT

## 4197

Inlet A: WELDED 4-BOLT FLANGE  
 Outlet A: 2.50" O.D. PIPE  
 Length: 25"



2000-97 6 BUICK PARK AVENUE 3.8L  
 1999-97 6 BUICK RIVIERA 3.8L

## 4198

Inlet A: WELDED 3-BOLT FLANGE W/ GASKET STUB  
 Outlet A: WELDED 2-BOLT FLANGE W/ GASKET STUB  
 Length: 10"



1997-90 8 LEXUS LS400 4.0L  
 1997-92 8 LEXUS SC400 4.0L

## 4202

Inlet A: WELDED 2-BOLT FLANGE W/ GASKET STUB  
 Outlet A: WELDED 2-BOLT FLANGE  
 Length: 27.50"

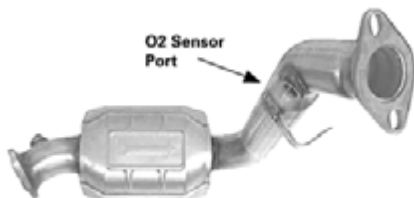

2003-98 4 FORD ESCORT 2.0L

## 4203

Inlet A: LOOSE 2-BOLT FLANGE W/ 2" FEMALE FLARE  
 Outlet A: LOOSE 2-BOLT FLANGE W/ 2" FLAT FLARE  
 Length: 15.25"



1988-87 4 DODGE COLT 1.5L  
 1988-87 4 DODGE COLT 1.6L  
 1989-87 4 DODGE RAIDER 2.6L  
 1989-87 4 DODGE RAM 50 PICKUP 2.0L  
 1989-87 4 DODGE RAM 50 PICKUP 2.6L  
 1994-90 4 HYUNDAI EXCEL 1.5L

## 4203 (cont.)

1995-91 4 HYUNDAI SCOUPE 1.5L  
 1988-83 4 MITSUBISHI CORDIA, TREDIA All  
 1988-87 4 MITSUBISHI MIRAGE 1.5L  
 1988-87 4 MITSUBISHI MIRAGE 1.6L  
 1989-87 4 MITSUBISHI MONTERO 2.6L  
 1988-87 4 PLYMOUTH COLT 1.5L  
 1988-87 4 PLYMOUTH COLT 1.6L

## 4204

Inlet A: WELDED 2-BOLT FLANGE  
 Outlet A: WELDED 2-BOLT FLANGE  
 Length: 28.50"



1997-96 4 TOYOTA RAV4 2.0L

## 4205

Inlet A: WELDED 3-BOLT FLANGE  
 Outlet A: WELDED 3-BOLT FLANGE  
 Length: 39"



2005-02 4 CHEVROLET CAVALIER 2.2L  
 2005-04 4 CHEVROLET MALIBU 2.2L  
 2004-02 4 OLDSMOBILE ALERO 2.2L  
 2005-02 4 PONTIAC GRAND AM 2.2L  
 2005-02 4 PONTIAC SUNFIRE 2.2L

## 4206

Inlet A: WELDED 4-BOLT FLANGE  
 Outlet A: 1.965" O.D. PIPE  
 Length: 50.25"



2002-00 6 AUDI A6 2.7L  
 2002-01 6 AUDI ALL ROAD 2.7L

## 4207

Inlet A: WELDED 4-BOLT FLANGE  
 Outlet A: 1.965" O.D. PIPE  
 Length: 43.25"



2002-00 6 AUDI A6 2.7L

### 4207 (cont.)

2002-01 6 AUDI ALL ROAD 2.7L

### 4209

Inlet A: WELDED 3-BOLT FLANGE  
 Outlet A: WELDED 3-BOLT FLANGE  
 Length: 16.88"



2003-01 6 ACURA CL 3.2L  
 2003-00 6 ACURA TL 3.2L  
 2002-00 6 HONDA ACCORD 3.0L  
 2004-99 6 HONDA ODYSSEY 3.5L

### 4210

Inlet A: WELDED 3-BOLT FLANGE  
 Outlet A: WELDED 3-BOLT FLANGE  
 Length: 44"



2000-99 4 SATURN SL2 1.9L

### 4211

Inlet A: 2.50" O.D. PIPE  
 Outlet A: 2.50" I.D. PIPE  
 Length: 24"



1991 6 BUICK REATTA 3.8L  
 1990-88 8 CADILLAC COMMERCIAL CHASSIS -  
 FUNERAL COACH, LIMOUSINE 4.5L  
 1993-92 8 CADILLAC DEVILLE 4.9L

### 4213

Inlet A: WELDED 4-BOLT FLANGE  
 Outlet A: 2.50" O.D. PIPE  
 Length: 72"



2007-05 6 CHRYSLER TOWN & COUNTRY 3.3L  
 2007-05 6 CHRYSLER TOWN & COUNTRY 3.8L  
 2007-05 6 DODGE CARAVAN 3.3L

### 4213 (cont.)

2007-05 6 DODGE CARAVAN 3.8L

### 4214

Inlet A: 2-BOLT FLANGE  
 Outlet A: 2.13" O.D. PIPE  
 Length: 59.63"



2002-98 6 MERCEDES-BENZ ML320 3.2L

### 4215

Inlet A: 2-BOLT FLANGE  
 Outlet A: 2.13" O.D. PIPE  
 Length: 60.25"



2002-98 6 MERCEDES-BENZ ML320 3.2L

### 4216

Inlet A: WELDED 2-BOLT FLANGE  
 Outlet A: WELDED 2-BOLT FLANGE W/ GASKET STUB  
 Length: 43.75"



1995-94 6 BUICK REGAL 3.8L

### 4217

Inlet A: WELDED 2-BOLT FLANGE  
 Outlet A: WELDED 2-BOLT FLANGE  
 Length: 36"



2003 4 SUBARU BAJA 2.5L  
 2005-99 4 SUBARU FORESTER 2.5L  
 2005-99 4 SUBARU IMPREZA 2.5L  
 2003-01 4 SUBARU LEGACY 2.5L  
 2003-01 4 SUBARU OUTBACK 2.5L

# DIRECT FIT

## 4218

Inlet A: LOOSE 2-BOLT FLANGE W/ SPHERICAL FLARE  
 Outlet A: 2.25" O.D. PIPE  
 Length: 48.25"



2002-00 8 JAGUAR S-TYPE 4.0L  
 2001-00 8 LINCOLN LS 3.9L

## 4219

Inlet A: LOOSE 2-BOLT FLANGE W/ SPHERICAL FLARE  
 Outlet A: 2.25" O.D. PIPE  
 Length: 46.75"



2002-00 8 JAGUAR S-TYPE 4.0L  
 2001-00 8 LINCOLN LS 3.9L

## 4220

Inlet A: WELDED 4-BOLT FLANGE  
 Outlet A: WELDED 3-BOLT FLANGE  
 Length: 38.25"



1997-96 4 OLDSMOBILE ACHIEVA 2.4L  
 1998-96 4 PONTIAC GRAND AM 2.4L

## 4221

Inlet A: WELDED 2-BOLT FLANGE  
 Inlet B: WELDED 2-BOLT FLANGE  
 Outlet A: WELDED 2-BOLT FLANGE  
 Length: 43.75"



1999-96 6 FORD TAURUS 3.0L  
 1999-96 6 MERCURY SABLE 3.0L

## 4223

Inlet A: 2.50" I.D. PIPE  
 Outlet A: 1.88" O.D. PIPE  
 Length: 65.50"



1990 6 CHRYSLER IMPERIAL 3.3L  
 1990-88 6 CHRYSLER NEW YORKER 3.0L  
 1991-88 6 DODGE DYNASTY 3.0L  
 1991-89 6 DODGE SPIRIT 3.0L  
 1991-89 6 PLYMOUTH ACCLAIM 3.0L

## 4224

Inlet A: WELDED 2-BOLT FLANGE W/ SPHERICAL FLARE  
 Inlet B: WELDED 2-BOLT FLANGE W/ SPHERICAL FLARE  
 Outlet A: WELDED 2-BOLT FLANGE  
 Length: 49"



2001-99 6 HYUNDAI SONATA 2.5L

## 4225

Inlet A: WELDED 4-BOLT FLANGE  
 Outlet A: 2.25" O.D. PIPE  
 Length: 39.50"

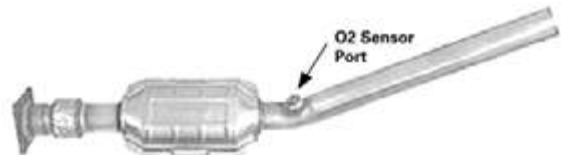

2000-98 4 DODGE STRATUS 2.0L  
 2000-98 4 PLYMOUTH BREEZE 2.0L

## 4227

Inlet A: WELDED 2-BOLT FLANGE  
 Outlet A: WELDED 3-BOLT FLANGE  
 Length: 40"



2005-01 4 HONDA CIVIC 1.7L

### 4228

Inlet A: WELDED 3-BOLT FLANGE  
 Outlet A: 1.88" O.D. PIPE  
 Length: 50.50"



2004-01 4 HYUNDAI SANTA FE 2.4L

### 4229

Inlet A: LOOSE 2-BOLT FLANGE W/ SPHERICAL FLARE  
 Outlet A: WELDED 4-BOLT FLANGE  
 Length: 49"



1996-94 6 BUICK CENTURY 3.1L  
 1996-94 6 OLDSMOBILE CIERA 3.1L

### 4230

Inlet A: WELDED 6-BOLT FLANGE  
 Outlet A: WELDED 2-BOLT FLANGE W/ GASKET STUB  
 Length: 15.38"



2003-01 4 ACURA EL 1.7L  
 2005-01 4 HONDA CIVIC 1.7L

### 4231

Inlet A: WELDED 2-BOLT FLANGE  
 Outlet A: WELDED 3-BOLT FLANGE  
 Length: 16.50"



1998-96 4 HONDA CIVIC 1.6L

### 4232

Inlet A: WELDED 2-BOLT FLANGE  
 Outlet A: WELDED 2-BOLT FLANGE W/ GASKET STUB  
 Length: 94.50"



2003-01 6 TOYOTA HIGHLANDER 3.0L

### 4233

Inlet A: WELDED 3-BOLT FLANGE  
 Outlet A: WELDED 3-BOLT FLANGE  
 Length: 13"



1999-97 6 ACURA CL 3.0L  
 1999 6 ACURA TL 3.2L  
 1999-98 6 HONDA ACCORD 3.0L

### 4234

Inlet A: WELDED 2-BOLT FLANGE  
 Outlet A: WELDED 2-BOLT FLANGE  
 Length: 36"



2002-99 6 OLDSMOBILE INTRIGUE 3.5L

### 4235

Inlet A: WELDED 9-BOLT FLANGE  
 Outlet A: WELDED 2-BOLT FLANGE  
 Length: 17.50"



2002-00 4 HYUNDAI ACCENT 1.5L

# DIRECT FIT

## 4236

Inlet A: WELDED 3-BOLT FLANGE W/ GASKET STUB  
 Outlet A: WELDED 2-BOLT FLANGE  
 Length: 26.50"

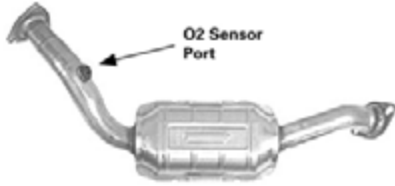

2004-99 6 NISSAN FRONTIER 3.3L  
 2004-00 6 NISSAN XTERRA 3.3L

## 4237

Inlet A: WELDED 3-BOLT FLANGE W/ GASKET STUB  
 Outlet A: WELDED 2-BOLT FLANGE  
 Length: 26.75"



2004-99 6 NISSAN FRONTIER 3.3L  
 2004-00 6 NISSAN XTERRA 3.3L

## 4238

Inlet A: LOOSE 2-BOLT FLANGE W/ FLAT FLARE  
 Outlet A: LOOSE 2-BOLT FLANGE W/ FLAT FLARE  
 Length: 17"

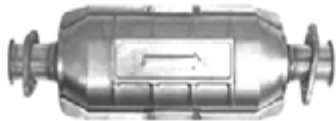

1996 6 HYUNDAI SONATA 3.0L  
 1998-96 4 HYUNDAI SONATA 2.0L

## 4240

Inlet A: WELDED 3-BOLT FLANGE  
 Outlet A: 2" O.D. PIPE  
 Length: 50"



2001-00 6 AUDI A6 2.8L  
 2001-00 8 AUDI A6 4.2L  
 2005-00 6 VOLKSWAGEN PASSAT 2.8L

## 4241

Inlet A: WELDED 3-BOLT FLANGE  
 Outlet A: 2" O.D. PIPE  
 Length: 51.25"



2001-00 6 AUDI A6 2.8L  
 2001-00 8 AUDI A6 4.2L  
 2005-00 6 VOLKSWAGEN PASSAT 2.8L

## 4242

Inlet A: LOOSE 2-BOLT FLANGE W/ SPHERICAL FLARE  
 Outlet A: 2.25" O.D. PIPE  
 Length: 58.38"



1995-93 6 CHEVROLET LUMINA APV 3.1L  
 1994-93 6 OLDSMOBILE SILHOUETTE 3.1L  
 1995-93 6 PONTIAC TRANS SPORT 3.1L

## 4243

Inlet A: WELDED 3-BOLT FLANGE  
 Outlet A: WELDED 3-BOLT FLANGE  
 Length: 42.75"



1999-96 4 SATURN SC1 1.9L  
 1999-96 4 SATURN SL / SL1 1.9L  
 1999-96 4 SATURN SW1 1.9L

## 4244

Inlet A: LOOSE 2-BOLT FLANGE W/ FEMALE FLARE  
 Outlet A: LOOSE 2-BOLT FLANGE W/ FLAT FLARE  
 Length: 33"



1991-86 8 FORD CROWN VICTORIA (Inc. Police, Taxi, Station Wagon) 5.0L  
 1990-86 8 LINCOLN TOWN CAR 5.0L  
 1991-86 8 MERCURY GRAND MARQUIS FULL SIZE 5.0L

### 4245

Inlet A: LOOSE 2-BOLT FLANGE W/ FEMALE FLARE  
 Outlet A: LOOSE 2-BOLT FLANGE W/ FLAT FLARE  
 Length: 30.50"



- 1991-86 8 FORD CROWN VICTORIA (Inc. Police, Taxi, Station Wagon) 5.0L
- 1990-86 8 LINCOLN TOWN CAR 5.0L
- 1991-86 8 MERCURY GRAND MARQUIS FULL SIZE 5.0L

### 4246

Inlet A: WELDED 2-BOLT FLANGE W/ SPHERICAL FLARE  
 Outlet A: WELDED 2-BOLT FLANGE  
 Length: 59"



- 2005-02 6 BUICK RENDEZVOUS 3.4L
- 2005-01 6 PONTIAC AZTEK 3.4L

### 4247

Inlet A: LOOSE 2-BOLT FLANGE W/ SPHERICAL FLARE  
 Inlet B: LOOSE 2-BOLT FLANGE W/ SPHERICAL FLARE  
 Outlet A: 1.965" O.D. PIPE  
 Outlet B: 1.965" O.D. PIPE  
 Length: 54.50"



- 2005-04 8 FORD THUNDERBIRD 3.9L
- 2004 8 LINCOLN LS 3.9L

### 4248

Inlet A: WELDED 2-BOLT FLANGE  
 Outlet A: WELDED 2-BOLT FLANGE W/ GASKET STUB  
 Length: 35.25"



- 2000-98 4 TOYOTA RAV4 2.0L

### 4249

Inlet A: WELDED 2-BOLT FLANGE  
 Outlet A: WELDED 3-BOLT FLANGE  
 Length: 17.63"



- 2001-97 4 HONDA CRV 2.0L
- 1997-96 4 HONDA ODYSSEY 2.2L
- 1997-96 4 ISUZU OASIS 2.2L

### 4251

Inlet A: WELDED 5-BOLT FLANGE  
 Outlet A: WELDED 2-BOLT FLANGE  
 Length: 12.13"



- 1999-98 4 HYUNDAI ACCENT 1.5L

### 4252

Inlet A: 45 DEGREE FLARE  
 Outlet A: 2.25" O.D. PIPE  
 Length: 23"



- 2004-99 6 CHRYSLER 300M 3.5L
- 2001-99 6 CHRYSLER LHS 3.5L
- 2000 6 DODGE INTREPID 3.5L

# DIRECT FIT

## 4253

Inlet A: WELDED 3-BOLT FLANGE  
 Outlet A: WELDED 3-BOLT FLANGE  
 Length: 16.88"

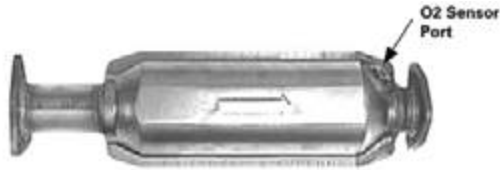

- 1999-97 6 ACURA CL 3.0L
- 1999 6 ACURA TL 3.2L
- 1999-98 6 HONDA ACCORD 3.0L

## 4254

Inlet A: WELDED 3-BOLT FLANGE  
 Outlet A: WELDED 3-BOLT FLANGE  
 Length: 54.50"



- 2002-99 4 DAEWOO NUBIRA 2.0L

## 4255

Inlet A: WELDED 3-BOLT FLANGE  
 Outlet A: WELDED 3-BOLT FLANGE  
 Length: 40"



- 2004-01 4 SATURN L100 2.2L
- 2004-01 4 SATURN L200 2.2L
- 2004-01 4 SATURN LW200 2.2L

## 4256

Inlet A: WELDED 2-BOLT FLANGE W/ GASKET STUB  
 Outlet A: LOOSE 2-BOLT FLANGE W/ MALE BALL  
 Length: 48.50"



- 2001-97 6 CADILLAC CATERA 3.0L

## 4257

Inlet A: WELDED 2-BOLT FLANGE W/ GASKET STUB  
 Outlet A: LOOSE 2-BOLT FLANGE W/ MALE BALL  
 Length: 49"



- 2001-97 6 CADILLAC CATERA 3.0L

## 4258

Inlet A: WELDED 3-BOLT FLANGE  
 Inlet B: WELDED 3-BOLT FLANGE  
 Outlet A: 2.575" O.D. PIPE  
 Length: 31.50"



- 2006-01 4 AUDI TT 1.8L

## 4259

Inlet A: WELDED 2-BOLT FLANGE W/ GASKET STUB  
 Inlet B: WELDED 2-BOLT FLANGE W/ GASKET STUB  
 Outlet A: WELDED 2-BOLT FLANGE  
 Length: 49.50"



- 1998-96 6 LEXUS ES300 3.0L
- 1999-96 6 TOYOTA AVALON 3.0L
- 2001-96 6 TOYOTA CAMRY, (Inc. 1998 & Older SOLARA) 3.0L
- 2002-99 6 TOYOTA SOLARA 3.0L

## 4262

Inlet A: WELDED 2-BOLT FLANGE  
 Outlet A: WELDED 2-BOLT FLANGE  
 Length: 41.50"



- 2003 4 HYUNDAI ELANTRA 2.0L
- 2006-03 4 HYUNDAI TIBURON 2.0L



### 4264

Inlet A: WELDED 2-BOLT FLANGE  
 Outlet A: WELDED 2-BOLT FLANGE  
 Length: 16.13"



2000-95 6 CHRYSLER SEBRING 2.5L  
 2000-95 6 DODGE AVENGER 2.5L

### 4269

Inlet A: WELDED 4-BOLT FLANGE  
 Outlet A: 2.50" O.D. PIPE  
 Length: 72"



2004-01 6 CHRYSLER TOWN & COUNTRY 3.8L  
 2004-01 6 DODGE CARAVAN 3.8L

### 4270

Inlet A: LOOSE 2-BOLT FLANGE W/ SPHERICAL FLARE  
 Outlet A: WELDED 2-BOLT FLANGE  
 Length: 37.50"



2006-03 8 FORD CROWN VICTORIA (Inc. Police, Taxi,  
 Station Wagon) 4.6L  
 2006-03 8 LINCOLN TOWN CAR 4.6L  
 2006-03 8 MERCURY GRAND MARQUIS FULL SIZE 4.6L  
 2004-03 8 MERCURY MARAUDER 4.6L

### 4271

Inlet A: LOOSE 2-BOLT FLANGE W/ SPHERICAL FLARE  
 Outlet A: WELDED 2-BOLT FLANGE  
 Length: 36.25"



2006-03 8 FORD CROWN VICTORIA (Inc. Police, Taxi,  
 Station Wagon) 4.6L  
 2006-03 8 LINCOLN TOWN CAR 4.6L

### 4271 (cont.)

2006-03 8 MERCURY GRAND MARQUIS FULL SIZE 4.6L  
 2004-03 8 MERCURY MARAUDER 4.6L

### 4272

Inlet A: WELDED 3-BOLT FLANGE  
 Outlet A: WELDED 2-BOLT FLANGE  
 Length: 10.25"



2000-99 8 LEXUS LS400 4.0L

### 4273

Inlet A: WELDED 3-BOLT FLANGE  
 Outlet A: WELDED 2-BOLT FLANGE  
 Length: 10.25"



2000-99 8 LEXUS LS400 4.0L

### 4274

Inlet A: WELDED 2-BOLT FLANGE W/ SPHERICAL FLARE  
 Outlet A: LOOSE 2-BOLT FLANGE W/ GASKET STUB  
 Length: 87.50"



2004-03 4 PONTIAC VIBE 1.8L  
 2004-03 4 TOYOTA COROLLA 1.8L  
 2004-03 4 TOYOTA MATRIX 1.8L

### 4275

Inlet A: WELDED 4-BOLT FLANGE  
 Outlet A: 2.25" O.D. PIPE  
 Length: 38.75"



2006-01 4 CHRYSLER SEBRING 2.4L  
 2006-01 4 DODGE STRATUS 2.4L

# DIRECT FIT

## 4276

Inlet A: WELDED 8-BOLT FLANGE  
 Outlet A: WELDED 3-BOLT FLANGE W/ GASKET STUB  
 Length: 33.25"



- 2005-98 6 LEXUS GS300 3.0L
- 2005-01 6 LEXUS IS300 3.0L
- 2000-98 6 LEXUS SC300 3.0L
- 1998 6 TOYOTA SUPRA 3.0L

## 4277

Inlet A: WELDED 4-BOLT FLANGE  
 Outlet A: 2.25" O.D. PIPE  
 Length: 72"



- 2007-01 6 CHRYSLER TOWN & COUNTRY 3.3L
- 2003-01 6 CHRYSLER VOYAGER, GRAND VOYAGER 3.3L
- 2007-01 6 DODGE CARAVAN 3.3L

## 4278

Inlet A: LOOSE 2-BOLT FLANGE W/ FEMALE FLARE  
 Inlet B: LOOSE 2-BOLT FLANGE W/ FEMALE FLARE  
 Outlet A: 2.25" O.D. PIPE  
 Length: 51.75"

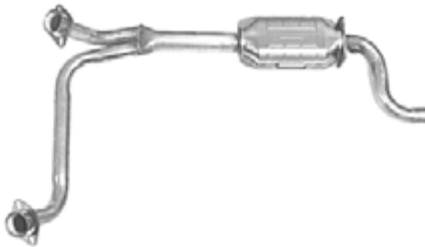

- 2002-00 6 CHEVROLET CAMARO 3.8L
- 2001-00 6 PONTIAC FIREBIRD, TRANS AM, FORMULA 3.8L

## 4279

Inlet A: WELDED 2-BOLT FLANGE  
 Inlet B: WELDED 2-BOLT FLANGE  
 Outlet A: WELDED 2-BOLT FLANGE  
 Length: 43.38"



- 1996-95 6 FORD WINDSTAR 3.0L

## 4280

Inlet A: LOOSE 2-BOLT FLANGE W/ 45 DEGREE FLARE  
 Outlet A: 2.165" O.D. PIPE  
 Length: 64.75"



- 2003-00 8 MERCEDES-BENZ CL500 5.0L
- 2002-00 8 MERCEDES-BENZ S430 4.3L
- 2002-00 8 MERCEDES-BENZ S500 5.0L

## 4281

Inlet A: LOOSE 2-BOLT FLANGE W/ 45 DEGREE FLARE  
 Outlet A: LOOSE 2-BOLT FLANGE W/ 45 DEGREE FLARE  
 Length: 61.50"



- 2003-00 8 MERCEDES-BENZ CL500 5.0L
- 2002-00 8 MERCEDES-BENZ S430 4.3L
- 2002-00 8 MERCEDES-BENZ S500 5.0L

## 4282

Inlet A: 2.13" I.D. PIPE  
 Outlet A: LOOSE 3-BOLT FLANGE W/ FLAT FLARE  
 Length: 21.50"



- 2002-93 4 SATURN SC1 1.9L
- 2002-93 4 SATURN SC2 1.9L
- 2002-93 4 SATURN SL / SL1 1.9L
- 2002-93 4 SATURN SL2 1.9L

### 4282 (cont.)

1999-93 4 SATURN SW1 1.9L  
2001-93 4 SATURN SW2 1.9L

### 4283

Inlet A: WELDED 2-BOLT FLANGE W/ CHRYSLER BEAD  
Outlet A: 2.25" O.D. PIPE  
Length: 33.50"



1993-92 6 CHRYSLER FIFTH AVENUE 3.3L  
1993-92 6 CHRYSLER FIFTH AVENUE 3.8L  
1993-92 6 CHRYSLER IMPERIAL 3.8L  
1993-92 6 CHRYSLER NEW YORKER 3.3L  
1993-92 6 DODGE DYNASTY 3.3L

### 4284

Inlet A: WELDED 3-BOLT FLANGE  
Outlet A: WELDED 2-BOLT FLANGE  
Length: 37.50"



2008 4 CHEVROLET COBALT 2.4L  
2010-08 4 CHEVROLET COBALT 2.2L  
2011-08 4 CHEVROLET HHR 2.2L  
2011-08 4 CHEVROLET HHR 2.4L  
2008 4 PONTIAC G5 2.4L  
2009-08 4 PONTIAC G5 2.2L

### 4285

Inlet A: WELDED 3-BOLT FLANGE  
Outlet A: 2.50" MALE BALL  
Length: 57.75"



2000 5 VOLVO S70/V70 2.3L  
2000 5 VOLVO S70/V70 2.4L

### 4286

Inlet A: WELDED 2-BOLT FLANGE  
Outlet A: WELDED 2-BOLT FLANGE  
Length: 15.50"

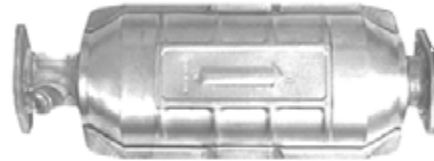

2003-02 4 MITSUBISHI LANCER 2.0L

### 4287

Inlet A: WELDED 3-BOLT FLANGE  
Outlet A: WELDED 3-BOLT FLANGE  
Length: 43.75"



1999-98 4 SATURN SC1 1.9L  
1999-98 4 SATURN SL / SL1 1.9L  
1999-98 4 SATURN SW1 1.9L

### 4288

Inlet A: WELDED 2-BOLT FLANGE  
Outlet A: WELDED 2-BOLT FLANGE  
Length: 13.25"



2002-01 4 KIA RIO 1.5L

# DIRECT FIT

## 4289

Inlet A: WELDED 2-BOLT FLANGE  
Outlet A: WELDED 3-BOLT FLANGE  
Length: 28.50"



2006-02 4 HONDA CRV 2.4L

## 4290

Inlet A: WELDED 3-BOLT FLANGE  
Outlet A: WELDED 3-BOLT FLANGE W/ GASKET STUB  
Length: 46.38"



2006-02 4 SATURN VUE 2.2L

## 4291

Inlet A: LOOSE 2-BOLT FLANGE W/ SPHERICAL FLARE  
Outlet A: WELDED 2-BOLT FLANGE  
Length: 18.13"



2000-94 6 MITSUBISHI MONTERO 3.5L

## 4292

Inlet A: WELDED 4-BOLT FLANGE  
Outlet A: 2.25" O.D. PIPE  
Length: 35.88"



2010-01 4 CHRYSLER PT CRUISER 2.4L

## 4293

Inlet A: WELDED 5-BOLT FLANGE  
Outlet A: WELDED 2-BOLT FLANGE  
Length: 20"



2003-01 4 TOYOTA RAV4 2.0L

## 4295

Inlet A: WELDED 2-BOLT FLANGE  
Outlet A: WELDED 2-BOLT FLANGE  
Length: 41.75"



2006-02 4 NISSAN ALTIMA 2.5L

## 4296

Inlet A: LOOSE 2-BOLT FLANGE W/ 45 DEGREE FLARE  
Outlet A: 2.165" O.D. PIPE  
Length: 67"



2002-98 6 MERCEDES-BENZ E320 3.2L

## 4297

Inlet A: LOOSE 2-BOLT FLANGE W/ 45 DEGREE FLARE  
Outlet A: LOOSE 2-BOLT FLANGE W/ 45 DEGREE FLARE  
Length: 64.75"



2002-98 6 MERCEDES-BENZ E320 3.2L

### 4298

Inlet A: WELDED 3-BOLT FLANGE  
 Outlet A: 2.50" O.D. PIPE  
 Length: 32.25"



2006-04 6 CHRYSLER PACIFICA 3.5L

### 4299

Inlet A: WELDED 3-BOLT FLANGE  
 Inlet B: WELDED 3-BOLT FLANGE  
 Outlet A: WELDED 3-BOLT FLANGE  
 Length: 42.25"



2005-00 6 SATURN L300 3.0L  
 2005-00 6 SATURN LW300 3.0L

### 4300

Inlet A: WELDED 3-BOLT FLANGE  
 Outlet A: WELDED 2-BOLT FLANGE  
 Length: 22"



2004-00 4 FORD FOCUS 2.0L

### 4301

Inlet A: LOOSE 2-BOLT FLANGE W/ 2" FEMALE FLARE  
 Outlet A: WELDED 2-BOLT FLANGE W/ 1.75" MALE BALL  
 Length: 47.38"



1994-86 4 SUZUKI SAMURAI 1.3L

### 4302

Inlet A: LOOSE 2-BOLT FLANGE W/ 2.50" FEMALE FLARE  
 Outlet A: WELDED 4-BOLT FLANGE  
 Length: 41"



1993-90 6 BUICK REGAL 3.8L

### 4303

Inlet A: LOOSE 2-BOLT FLANGE W/ 2.25" FEMALE FLARE  
 Outlet A: 2.25" O.D. PIPE  
 Length: 24"



1982 6 BUICK SKYLARK 2.8L  
 1985 8 CADILLAC DEVILLE 4.1L  
 1987-86 8 CADILLAC ELDORADO 4.1L  
 1987-86 8 CADILLAC SEVILLE 4.1L  
 1982 6 CHEVROLET CITATION 2.8L  
 1987-85 6 CHEVROLET EL CAMINO 4.3L  
 1990-85 6 CHEVROLET FULL SIZE (Inc. Impala RWD, Caprice, Belair, Police, Taxi, Station Wagon) 4.3L  
 1988-85 6 CHEVROLET MONTE CARLO 4.3L  
 1987-85 6 GMC CABALLERO/SPRINT 4.3L  
 1982 6 OLDSMOBILE OMEGA 2.8L  
 1986 6 PONTIAC BONNEVILLE 4.3L  
 1987-86 6 PONTIAC GRAND PRIX 4.3L  
 1986 6 PONTIAC PARISIENNE 4.3L  
 1982 6 PONTIAC PHOENIX 2.8L

### 4304

Inlet A: WELDED 2-BOLT FLANGE W/ GASKET STUB  
 Outlet A: WELDED 2-BOLT FLANGE  
 Length: 36"

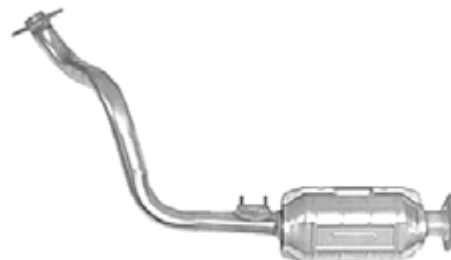

1992-91 6 TOYOTA LAND CRUISER 4.0L

# DIRECT FIT

## 4305

Inlet A: WELDED 2-BOLT FLANGE W/ GASKET STUB  
 Outlet A: WELDED 2-BOLT FLANGE  
 Length: 45"

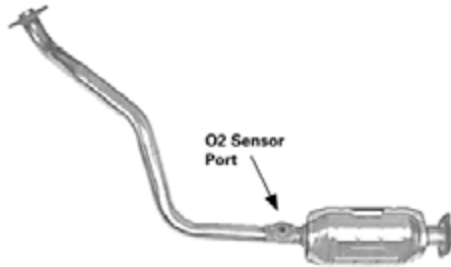

1992-91 6 TOYOTA LAND CRUISER 4.0L

## 4306

Inlet A: 2" I.D. PIPE  
 Outlet A: 2" I.D. PIPE  
 Length: 27"



1989-87 4 CHEVROLET BERETTA 2.0L  
 1992-87 6 CHEVROLET BERETTA AII  
 1992-90 4 CHEVROLET BERETTA 2.2L  
 1992-87 4 CHEVROLET CORSICA AII  
 1992-87 6 CHEVROLET CORSICA AII

## 4307

Inlet A: WELDED 2-BOLT FLANGE  
 Outlet A: WELDED 2-BOLT FLANGE  
 Length: 60"



2005-02 6 CHEVROLET VENTURE 3.4L  
 2004-02 6 OLDSMOBILE SILHOUETTE 3.4L  
 2005-02 6 PONTIAC MONTANA 3.4L

## 4309

Inlet A: WELDED 3-BOLT FLANGE  
 Outlet A: WELDED 2-BOLT FLANGE  
 Length: 24.50"



2002-01 4 KIA SPORTAGE 2.0L

## 4312

Inlet A: WELDED 4-BOLT FLANGE  
 Outlet A: 2.355" O.D. PIPE  
 Length: 40.50"



2004-00 4 VOLVO S40/V40 1.9L

## 4315

Inlet A: WELDED 2-BOLT FLANGE  
 Outlet A: WELDED 2-BOLT FLANGE W/ GASKET STUB  
 Length: 30.50"



2001-95 4 SUZUKI ESTEEM 1.6L  
 2002-99 4 SUZUKI ESTEEM 1.8L

## 4316

Inlet A: WELDED 3-BOLT FLANGE  
 Outlet A: WELDED 3-BOLT FLANGE  
 Length: 41.50"



2002-01 4 SATURN SC2 1.9L  
 2002-01 4 SATURN SL2 1.9L  
 2001 4 SATURN SW2 1.9L

## 4317

Inlet A: WELDED 2-BOLT FLANGE  
 Outlet A: WELDED 2-BOLT FLANGE  
 Length: 12.38"



2002-00 4 INFINITI G20 2.0L  
 2001-00 6 INFINITI I30 3.0L  
 1998-95 4 NISSAN 240SX 2.4L  
 2001-00 4 NISSAN ALTIMA 2.4L

### 4317 (cont.)

2001-00	6	NISSAN MAXIMA 3.0L
2001-00	4	NISSAN SENTRA 2.0L
2002-00	4	NISSAN SENTRA 1.8L
2004-00	4	NISSAN XTERRA 2.4L

### 4318

Inlet A: WELDED 3-BOLT FLANGE W/ GASKET STUB  
 Outlet A: WELDED 2-BOLT FLANGE  
 Length: 25.25"



2000-98	6	INFINITI QX4 3.3L
2001	6	INFINITI QX4 3.5L
2000-98	6	NISSAN PATHFINDER 3.3L
2001	6	NISSAN PATHFINDER 3.5L

### 4319

Inlet A: WELDED 3-BOLT FLANGE W/ GASKET STUB  
 Outlet A: WELDED 2-BOLT FLANGE  
 Length: 25.25"



2000-98	6	INFINITI QX4 3.3L
2001	6	INFINITI QX4 3.5L
2000-98	6	NISSAN PATHFINDER 3.3L
2001	6	NISSAN PATHFINDER 3.5L

### 4320

Inlet A: WELDED 2-BOLT FLANGE W/ GASKET STUB  
 Outlet A: WELDED 2-BOLT FLANGE W/ GASKET STUB  
 Length: 49"



2009-02	4	TOYOTA CAMRY, (Inc. 1998 & Older SOLARA) 2.4L
2008-02	4	TOYOTA SOLARA 2.4L

### 4321

Inlet A: LOOSE 2-BOLT FLANGE W/ SPHERICAL FLARE  
 Inlet B: LOOSE 2-BOLT FLANGE W/ SPHERICAL FLARE  
 Outlet A: 2.50" O.D. PIPE  
 Length: 53.88"

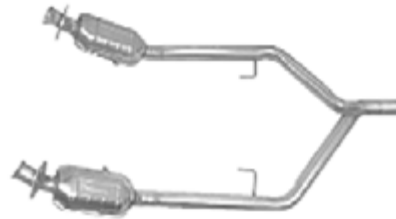

2010-05	6	FORD MUSTANG 4.0L
---------	---	-------------------

### 4322

Inlet A: WELDED 2-BOLT FLANGE W/ GASKET STUB  
 Inlet B: LOOSE 2-BOLT FLANGE W/ SPHERICAL FLARE  
 Outlet A: LOOSE 2-BOLT FLANGE W/ MALE BALL  
 Outlet B: LOOSE 2-BOLT FLANGE W/ MALE BALL  
 Length: 53.75"

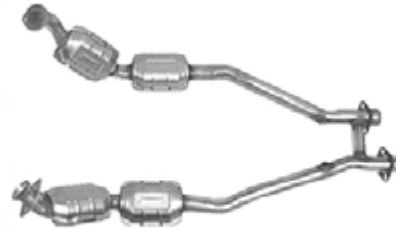

2003-99	8	FORD MUSTANG 4.6L
---------	---	-------------------

### 4323

Inlet A: WELDED 3-BOLT FLANGE W/ GASKET STUB  
 Outlet A: WELDED 2-BOLT FLANGE  
 Length: 30"



1998-95	4	NISSAN 240SX 2.4L
---------	---	-------------------

# DIRECT FIT

## 4324

Inlet A: WELDED 2-BOLT FLANGE W/ GASKET STUB  
 Inlet B: WELDED 2-BOLT FLANGE W/ GASKET STUB  
 Outlet A: WELDED 2-BOLT FLANGE  
 Length: 47"



2005-03 6 HYUNDAI TIBURON 2.7L

## 4326

Inlet A: WELDED 2-BOLT FLANGE  
 Outlet A: SPHERICAL RING  
 Length: 77.25"



2006-04 4 SCION XA 1.5L  
 2005-00 4 TOYOTA ECHO 1.5L

## 4327

Inlet A: WELDED 2-BOLT FLANGE  
 Outlet A: WELDED 2-BOLT FLANGE  
 Length: 65"



2001 6 CHEVROLET VENTURE 3.4L  
 2001 6 OLDSMOBILE SILHOUETTE 3.4L  
 2001 6 PONTIAC MONTANA 3.4L

## 4328

Inlet A: LOOSE 2-BOLT FLANGE W/ FEMALE FLARE  
 Inlet B: LOOSE 2-BOLT FLANGE W/ FEMALE FLARE  
 Outlet A: 2.50" O.D. PIPE  
 Outlet B: 2.50" O.D. PIPE  
 Length: 50.50"

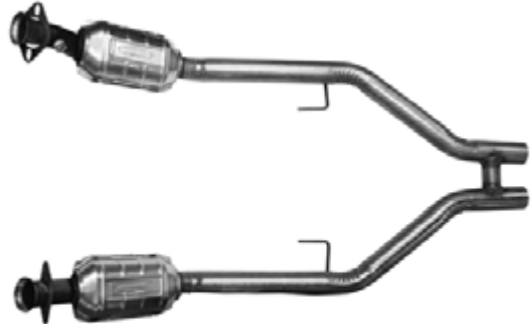

2007-05 8 FORD MUSTANG 4.6L

## 4329

Inlet A: WELDED 2-BOLT FLANGE  
 Outlet A: WELDED 2-BOLT FLANGE  
 Length: 25.50"

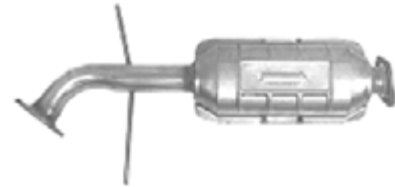

2005-02 6 KIA SEDONA 3.5L

## 4330

Inlet A: WELDED 2-BOLT FLANGE  
 Outlet A: 2.25" O.D. PIPE  
 Length: 52.50"



2010-05 6 CHRYSLER 300 2.7L  
 2010-05 6 CHRYSLER 300 3.5L  
 2010-09 6 DODGE CHALLENGER 3.5L  
 2010-06 6 DODGE CHARGER 2.7L  
 2010-06 6 DODGE CHARGER 3.5L  
 2008-05 6 DODGE MAGNUM 2.7L  
 2008-05 6 DODGE MAGNUM 3.5L



### 4331

Inlet A: WELDED 2-BOLT FLANGE  
 Outlet A: 2.25" O.D. PIPE  
 Length: 52.50"



- 2010-05 6 CHRYSLER 300 2.7L
- 2010-05 6 CHRYSLER 300 3.5L
- 2010-09 6 DODGE CHALLENGER 3.5L
- 2010-06 6 DODGE CHARGER 2.7L
- 2010-06 6 DODGE CHARGER 3.5L
- 2008-05 6 DODGE MAGNUM 2.7L
- 2008-05 6 DODGE MAGNUM 3.5L

### 4332

Inlet A: WELDED 2-BOLT FLANGE  
 Outlet A: WELDED 2-BOLT FLANGE  
 Length: 52.63"



- 2005-01 4 CHRYSLER SEBRING 2.4L
- 2005-01 4 DODGE STRATUS 2.4L
- 2005-00 4 MITSUBISHI ECLIPSE 2.4L
- 2003-00 4 MITSUBISHI GALANT 2.4L

### 4336

Inlet A: WELDED 2-BOLT FLANGE W/ GASKET STUB  
 Inlet B: WELDED 2-BOLT FLANGE W/ GASKET STUB  
 Outlet A: WELDED 2-BOLT FLANGE W/ GASKET STUB  
 Length: 24.50"

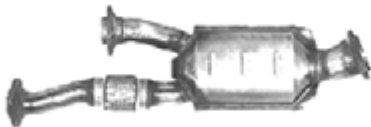

- 1994-93 6 LEXUS GS300 3.0L
- 1994-93 6 LEXUS SC300 3.0L

### 4337

Inlet A: WELDED 2-BOLT FLANGE  
 Outlet A: WELDED 2-BOLT FLANGE W/ GASKET STUB  
 Length: 38.13"



- 1997-93 6 LEXUS GS300 3.0L
- 1997-93 6 LEXUS SC300 3.0L

### 4338

Inlet A: WELDED 2-BOLT FLANGE  
 Outlet A: 1.88" O.D. PIPE  
 Length: 19"

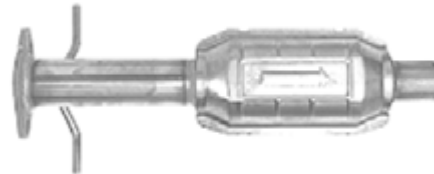

- 2007-03 4 FORD FOCUS 2.3L
- 2007-05 4 FORD FOCUS 2.0L
- 2009 4 FORD FUSION 2.3L

### 4339

Inlet A: WELDED 3-BOLT FLANGE  
 Outlet A: WELDED 3-BOLT FLANGE  
 Length: 43.50"



- 2002-01 4 SATURN SC1 1.9L
- 2002-01 4 SATURN SL / SL1 1.9L

# DIRECT FIT

## 4340

Inlet A: WELDED 9-BOLT FLANGE  
 Outlet A: WELDED 3-BOLT FLANGE  
 Length: 13.75"



1997-96 4 HONDA CIVIC DEL SOL 1.6L  
 2000-96 4 HONDA CIVIC 1.6L

## 4341

Inlet A: WELDED 2-BOLT FLANGE  
 Outlet A: WELDED 2-BOLT FLANGE W/ GASKET STUB  
 Length: 37.88"



2009-05 6 BUICK LACROSSE 3.8L  
 2008-04 6 PONTIAC GRAND PRIX 3.8L

## 4342

Inlet A: WELDED 2-BOLT FLANGE  
 Outlet A: WELDED 2-BOLT FLANGE W/ GASKET STUB  
 Length: 45"



2001-98 4 CHEVROLET METRO 1.3L  
 1997 4 GEO METRO 1.3L  
 2001-98 4 SUZUKI SWIFT 1.3L

## 4343

Inlet A: WELDED 3-BOLT FLANGE W/ GASKET STUB  
 Outlet A: WELDED 2-BOLT FLANGE  
 Length: 50.50"



2006-03 4 NISSAN SENTRA 1.8L

## 4344

Inlet A: 45 DEGREE FLARE  
 Outlet A: 2.25" O.D. PIPE  
 Length: 46.63"



2004-02 6 CHRYSLER CONCORDE 2.7L  
 2004-02 6 DODGE INTREPID 2.7L

## 4345

Inlet A: WELDED 3-BOLT FLANGE W/ GASKET STUB  
 Outlet A: WELDED 2-BOLT FLANGE  
 Length: 10.13"



1997-92 8 LEXUS SC400 4.0L

## 4347

Inlet A: WELDED 2-BOLT FLANGE  
 Outlet A: 2.25" O.D. PIPE  
 Length: 24"



2008-06 4 TOYOTA RAV4 2.4L  
 2013-09 4 TOYOTA RAV4 2.5L

## 4348

Inlet A: WELDED 2-BOLT FLANGE  
 Outlet A: WELDED 2-BOLT FLANGE  
 Length: 15.75"



2009-06 4 HYUNDAI SONATA 2.4L  
 2008-06 4 KIA OPTIMA 2.4L  
 2009-07 4 KIA RONDO 2.4L

### 4349

Inlet A: WELDED 2-BOLT FLANGE  
 Outlet A: WELDED 2-BOLT FLANGE  
 Length: 40.50"



2003-01 4 MAZDA PROTÉGÉ 2.0L

### 4352

Inlet A: WELDED 3-BOLT FLANGE  
 Outlet A: WELDED 3-BOLT FLANGE  
 Length: 53.63"



2002-99 4 DAEWOO LEGANZA 2.2L

### 4355

Inlet A: WELDED 2-BOLT FLANGE  
 Outlet A: WELDED 3-BOLT FLANGE  
 Length: 16"

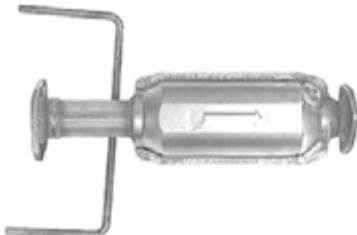

1997 4 ACURA CL 2.2L  
 1997-96 4 HONDA ACCORD 2.2L

### 4356

Inlet A: WELDED 6-BOLT FLANGE  
 Outlet A: WELDED 3-BOLT FLANGE  
 Length: 12.50"

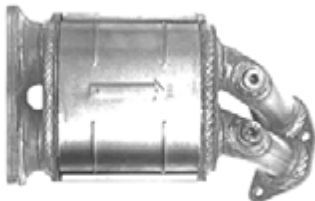

2002-00 4 NISSAN SENTRA 1.8L

### 4357

Inlet A: WELDED 2-BOLT FLANGE  
 Outlet A: WELDED 3-BOLT FLANGE  
 Length: 47"



2009-05 6 CHEVROLET EQUINOX 3.4L  
 2009-06 6 PONTIAC TORRENT 3.4L

### 4358

Inlet A: WELDED 3-BOLT FLANGE  
 Outlet A: WELDED 2-BOLT FLANGE  
 Length: 48.25"



2005-99 4 HYUNDAI SONATA 2.4L  
 2006-01 4 KIA OPTIMA 2.4L

### 4359

Inlet A: LOOSE 2-BOLT FLANGE W/ FLAT FLARE  
 Outlet A: LOOSE 2-BOLT FLANGE W/ FLAT FLARE  
 Length: 16.25"

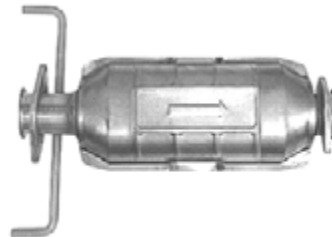

1999-95 4 CHRYSLER SEBRING 2.0L  
 1998-95 4 EAGLE TALON 2.0L  
 1998-95 4 MITSUBISHI ECLIPSE 2.0L  
 1998-96 4 MITSUBISHI ECLIPSE 2.4L  
 1998-94 4 MITSUBISHI GALANT 2.4L

### 4361

Inlet A: WELDED 2-BOLT FLANGE  
 Outlet A: WELDED 3-BOLT FLANGE  
 Length: 17.50"

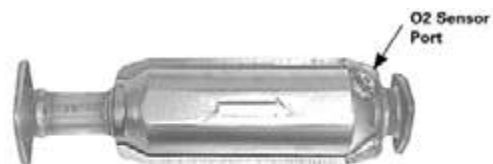

1999-96 4 ACURA INTEGRA 1.8L

# DIRECT FIT

## 4363

Inlet A: WELDED 2-BOLT FLANGE  
 Outlet A: WELDED 3-BOLT FLANGE  
 Length: 16.13"

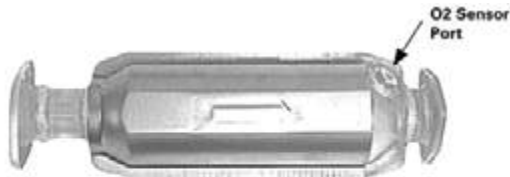

- 1998 4 HONDA ODYSSEY 2.3L
- 1999-98 4 ISUZU OASIS 2.3L

## 4364

Inlet A: WELDED 3-BOLT FLANGE W/ GASKET STUB  
 Outlet A: WELDED 2-BOLT FLANGE  
 Length: 36"



- 2002-98 6 HONDA PASSPORT 3.2L
- 2002-98 6 ISUZU RODEO 3.2L

## 4365

Inlet A: WELDED 3-BOLT FLANGE W/ GASKET STUB  
 Outlet A: WELDED 2-BOLT FLANGE  
 Length: 42"



- 2002-98 6 HONDA PASSPORT 3.2L
- 2002-98 6 ISUZU RODEO 3.2L

## 4366

Inlet A: WELDED 2-BOLT FLANGE  
 Outlet A: WELDED 2-BOLT FLANGE  
 Length: 15.25"



- 1997-96 4 SUBARU IMPREZA 1.8L
- 1998 4 SUBARU IMPREZA 2.5L
- 2001-95 4 SUBARU IMPREZA 2.2L
- 1999-95 4 SUBARU LEGACY 2.2L
- 2002-96 4 SUBARU LEGACY 2.5L

## 4366 (cont.)

- 2000 4 SUBARU OUTBACK 2.5L

## 4367

Inlet A: WELDED 2-BOLT FLANGE  
 Outlet A: WELDED 2-BOLT FLANGE W/ GASKET STUB  
 Length: 23.25"



- 1998 4 SUBARU FORESTER 2.5L
- 1998 4 SUBARU IMPREZA 2.5L
- 2001-95 4 SUBARU IMPREZA 2.2L
- 1999-95 4 SUBARU LEGACY 2.2L
- 2002-96 4 SUBARU LEGACY 2.5L
- 2000 4 SUBARU OUTBACK 2.5L

## 4368

Inlet A: WELDED 2-BOLT FLANGE  
 Outlet A: WELDED 2-BOLT FLANGE  
 Length: 12.38"



- 2004-02 6 INFiniti I35 3.5L
- 2003-02 6 NISSAN MAXIMA 3.5L

## 4369

Inlet A: WELDED 4-BOLT FLANGE  
 Outlet A: 2.165" O.D. PIPE  
 Length: 42"



- 2004-99 4 VOLKSWAGEN BEETLE 1.8L
- 2003-00 4 VOLKSWAGEN GOLF 1.8L
- 2003-00 4 VOLKSWAGEN JETTA 1.8L

### 4370

Inlet A: LOOSE 2-BOLT FLANGE W/ SPHERICAL FLARE  
 Outlet A: 2.50" O.D. PIPE  
 Length: 31.75"



1995 8 OLDSMOBILE AURORA 4.0L

### 4371

Inlet A: WELDED 4-BOLT FLANGE  
 Outlet A: 2.165" O.D. PIPE  
 Length: 42"



2005-01 4 VOLKSWAGEN BEETLE 2.0L  
 2006-01 4 VOLKSWAGEN GOLF 2.0L  
 2005-02 4 VOLKSWAGEN JETTA 2.0L

### 4372

Inlet A: LOOSE 2-BOLT FLANGE W/ SPHERICAL FLARE  
 Inlet B: LOOSE 2-BOLT FLANGE W/ SPHERICAL FLARE  
 Outlet A: WELDED 2-BOLT FLANGE  
 Length: 45"



2007-04 6 FORD FREESTAR 3.9L  
 2007-04 6 FORD FREESTAR 4.2L  
 2003-01 6 FORD WINDSTAR 3.8L  
 2007-04 6 MERCURY MONTEREY 4.2L

### 4373

Inlet A: WELDED 2-BOLT FLANGE  
 Outlet A: WELDED 2-BOLT FLANGE W/ GASKET STUB  
 Length: 101.50"



2001-99 6 LEXUS ES300 3.0L

### 4374

Inlet A: WELDED 3-BOLT FLANGE  
 Outlet A: 1.965" O.D. PIPE  
 Length: 49.25"



1999-97 6 AUDI A4 2.8L  
 1999-98 6 AUDI A6 2.8L  
 1999-98 6 VOLKSWAGEN PASSAT 2.8L

### 4375

Inlet A: WELDED 3-BOLT FLANGE  
 Outlet A: 1.965" O.D. PIPE  
 Length: 62.75"



1999-97 6 AUDI A4 2.8L

### 4376

Inlet A: WELDED 2-BOLT FLANGE  
 Outlet A: WELDED 2-BOLT FLANGE  
 Length: 39"



2009-06 6 CHEVROLET IMPALA FWD 3.5L  
 2009-06 6 CHEVROLET IMPALA FWD 3.9L  
 2006 6 CHEVROLET MONTE CARLO 3.9L  
 2007-06 6 CHEVROLET MONTE CARLO 3.5L

### 4377

Inlet A: LOOSE 2-BOLT FLANGE W/ 2" FLAT FLARE  
 Outlet A: LOOSE 2-BOLT FLANGE W/ 2" FLAT FLARE  
 Length: 17.50"



1988 4 CHEVROLET NOVA 1.6L  
 1990-89 4 DODGE 2000 GTX All  
 1990-89 4 DODGE COLT 1.6L  
 1991-87 4 DODGE COLT 2.0L  
 1991-89 4 DODGE COLT 1.5L  
 1994-92 4 DODGE COLT All  
 1989 6 DODGE RAIDER 3.0L  
 1992-90 4 DODGE RAM 50 PICKUP 2.4L  
 1995-91 6 DODGE STEALTH 3.0L  
 1990-89 4 EAGLE SUMMIT 1.6L

**4377 (cont.)**

1994-93	4	EAGLE SUMMIT 1.8L
1995-89	4	EAGLE SUMMIT 1.5L
1994-90	4	EAGLE TALON All
1992-89	4	EAGLE VISTA 1.5L
1989-88	4	FORD FESTIVA 1.3L
1995-90	4	GEO PRIZM 1.6L
1995-93	4	GEO PRIZM 1.8L
1994-93	4	HYUNDAI ELANTRA 1.8L
1995-92	4	HYUNDAI ELANTRA 1.6L
1995-93	4	HYUNDAI SCOUPE 1.5L
1991-89	4	HYUNDAI SONATA 2.4L
1995-92	4	HYUNDAI SONATA 2.0L
1994	4	KIA SEPHIA 1.6L
1991-90	6	LEXUS ES250 2.5L
1981-80	4	MAZDA 626 2.0L
1991-90	6	MAZDA 929 3.0L
1987-79	4	MAZDA B-Series PICKUP 2.0L
1989-87	4	MAZDA B-Series PICKUP 2.6L
1993-87	4	MAZDA B-Series PICKUP 2.2L
1993-89	6	MAZDA MPV VAN 3.0L
1994-89	4	MAZDA MPV VAN 2.6L
1994-90	4	MAZDA MPV VAN 2.0L
1995-92	4	MAZDA MPV VAN 2.4L
1995-92	4	MAZDA MPV VAN 2.0L
1992-89	4	MAZDA MPV VAN 3.0L
1992-89	4	MAZDA MPV VAN 2.6L
1994-90	4	MAZDA MPV VAN 2.0L
1995-92	4	MAZDA MPV VAN 2.4L
1995-92	4	MAZDA MPV VAN 2.0L
1992-89	4	MAZDA MPV VAN 3.0L
1992-89	4	MAZDA MPV VAN 2.6L
1995-90	4	MAZDA MPV VAN 2.0L
1994-90	4	MAZDA MPV VAN 2.4L
1990-87	4	MAZDA MPV VAN 2.0L
1980	4	MAZDA MPV VAN 3.0L
1979	6	MAZDA MPV VAN 2.8L
1980	6	MAZDA MPV VAN 2.8L
1982-81	4	MAZDA MPV VAN 1.5L
1981-79	4	MAZDA MPV VAN F-10 All
1980-79	6	MAZDA MPV VAN 2.4L
1994-93	4	MAZDA MPV VAN 2.4L
1979-77	4	MAZDA MPV VAN 2.10 All
1991-88	4	MAZDA MPV VAN All
1994-83	4	MAZDA MPV VAN 2.4L
1991-90	4	MAZDA MPV VAN 2.4L
1990-89	4	MAZDA MPV VAN 1.6L
1991-87	4	MAZDA MPV VAN 2.0L
1991-89	4	MAZDA MPV VAN 1.5L
1994-92	4	MAZDA MPV VAN All
1994-90	4	MAZDA MPV VAN LASER All
1994-84	4	MAZDA MPV VAN 2.4L
1986-83	4	MAZDA MPV VAN CAMRY, (Inc. 1998 & Older SOLARA) 2.0L
1980-79	4	MAZDA MPV VAN CELICA All
1985-84	4	MAZDA MPV VAN CELICA 2.4L
1986	4	MAZDA MPV VAN CELICA 2.0L
1986-76	4	MAZDA MPV VAN COROLLA All
1995-87	4	MAZDA MPV VAN COROLLA 1.6L
1995-93	4	MAZDA MPV VAN COROLLA 1.8L
1980-79	4	MAZDA MPV VAN CORONA 2.2L
1982-81	4	MAZDA MPV VAN CORONA 2.4L
1982-78	6	MAZDA MPV VAN CRESSIDA All
1988-83	6	MAZDA MPV VAN CRESSIDA 2.8L
1989-85	4	MAZDA MPV VAN MR2 1.6L
1995-92	4	MAZDA MPV VAN PASEO 1.5L
1983-75	4	MAZDA MPV VAN PICKUP (ALL MODELS Exc. TACOMA & TUNDRA) All
1984-81	4	MAZDA MPV VAN STARLET 1.3L

**4377 (cont.)**

1986-81	6	TOYOTA SUPRA 2.8L
1986-80	4	TOYOTA TERCEL All
1994-88	4	TOYOTA TERCEL 1.5L
1987-84	4	TOYOTA VAN All

**4378**

**Inlet A: LOOSE 2-BOLT FLANGE W/ FLARE**  
**Outlet A: LOOSE 2-BOLT FLANGE W/ FLARE**  
**Length: 39.25"**



2008-04	6	CHRYSLER CROSSFIRE 3.2L
2004-01	6	MERCEDES-BENZ SLK320 3.2L

**4379**

**Inlet A: LOOSE 2-BOLT FLANGE W/ FLARE**  
**Inlet B: LOOSE 2-BOLT FLANGE W/ FLARE**  
**Outlet A: LOOSE 3-BOLT FLANGE W/ FLARE**  
**Length: 59.50"**



2008-04	6	CHRYSLER CROSSFIRE 3.2L
2004-01	6	MERCEDES-BENZ SLK320 3.2L

**4380**

**Inlet A: WELDED 3-BOLT FLANGE**  
**Outlet A: WELDED 2-BOLT FLANGE**  
**Length: 40.50"**



2006-02	6	MAZDA MPV VAN 3.0L
---------	---	--------------------

### 4381

Inlet A: WELDED 2-BOLT FLANGE  
 Outlet A: WELDED 2-BOLT FLANGE W/ GASKET STUB  
 Length: 19.50"

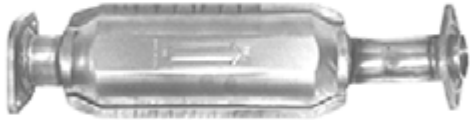

2006-02 6 MAZDA MPV VAN 3.0L

### 4383

Inlet A: WELDED 2-BOLT FLANGE  
 Inlet B: WELDED 2-BOLT FLANGE  
 Outlet A: WELDED 2-BOLT FLANGE  
 Length: 49.75"



2003-02 6 LEXUS ES300 3.0L  
 2006-04 6 LEXUS ES330 3.3L  
 2006-02 6 TOYOTA CAMRY, (Inc. 1998 & Older SOLARA) 3.0L  
 2006-04 6 TOYOTA CAMRY, (Inc. 1998 & Older SOLARA) 3.3L  
 2008-04 6 TOYOTA SOLARA 3.3L

### 4384

Inlet A: WELDED 2-BOLT FLANGE  
 Outlet A: WELDED 2-BOLT FLANGE W/ GASKET STUB  
 Length: 30"



2005-03 6 MAZDA 6 3.0L

### 4385

Inlet A: WELDED 3-BOLT FLANGE W/ GASKET STUB  
 Outlet A: WELDED 2-BOLT FLANGE W/ GASKET STUB  
 Length: 22.50"



2005-03 6 MAZDA 6 3.0L

### 4386

Inlet A: WELDED 8-BOLT FLANGE  
 Outlet A: WELDED 2-BOLT FLANGE  
 Length: 32"



2006-01 6 BMW 325 2.5L  
 2005-01 6 BMW 330 3.0L  
 2002-01 6 BMW Z3 2.5L  
 2002-01 6 BMW Z3 3.0L

### 4387

Inlet A: WELDED 8-BOLT FLANGE  
 Outlet A: WELDED 2-BOLT FLANGE  
 Length: 23.25"



2006-01 6 BMW 325 2.5L  
 2005-01 6 BMW 330 3.0L  
 2002-01 6 BMW Z3 2.5L  
 2002-01 6 BMW Z3 3.0L

# DIRECT FIT

## 4388

Inlet A: WELDED 2-BOLT FLANGE  
 Inlet B: WELDED 2-BOLT FLANGE  
 Outlet A: WELDED 2-BOLT FLANGE  
 Length: 51.25"



2002-97 6 TOYOTA CAMRY, (Inc. 1998 & Older SOLARA)  
 3.0L

## 4392

Inlet A: WELDED 2-BOLT FLANGE  
 Outlet A: 2.25" O.D. PIPE  
 Length: 17.13"



2007-05 6 FORD FIVE HUNDRED 3.0L  
 2007-05 6 FORD FREESTYLE 3.0L  
 2007-05 6 MERCURY MONTEGO 3.0L

## 4390

Inlet A: WELDED 2-BOLT FLANGE  
 Outlet A: WELDED 2-BOLT FLANGE  
 Length: 20"



2007-05 6 FORD FIVE HUNDRED 3.0L  
 2007-05 6 MERCURY MONTEGO 3.0L

## 4393

Inlet A: WELDED 2-BOLT FLANGE  
 Inlet B: WELDED 2-BOLT FLANGE  
 Outlet A: WELDED 2-BOLT FLANGE  
 Length: 54.25"



2005-01 6 CHRYSLER SEBRING 3.0L  
 2005-01 6 DODGE STRATUS 3.0L  
 2005-00 6 MITSUBISHI ECLIPSE 3.0L  
 2003-99 6 MITSUBISHI GALANT 3.0L

## 4391

Inlet A: WELDED 2-BOLT FLANGE  
 Outlet A: WELDED 2-BOLT FLANGE  
 Length: 18"



2007-05 6 FORD FIVE HUNDRED 3.0L  
 2007-05 6 FORD FREESTYLE 3.0L  
 2007-05 6 MERCURY MONTEGO 3.0L

## 4394

Inlet A: 2-BOLT FLANGE W/ SPHERICAL FLARE  
 Inlet B: 2-BOLT FLANGE W/ SPHERICAL FLARE  
 Outlet A: WELDED 2-BOLT FLANGE  
 Length: 42.50"



1999-96 8 FORD TAURUS 3.4L

## 4395

Inlet A: WELDED 2-BOLT FLANGE  
 Outlet A: 2.25" O.D. PIPE  
 Length: 11"



1999-96 8 FORD TAURUS 3.4L



### 4396

Inlet A: WELDED 3-BOLT FLANGE W/ GASKET STUB  
 Inlet B: WELDED 3-BOLT FLANGE W/ GASKET STUB  
 Outlet A: WELDED 2-BOLT FLANGE  
 Length: 38.25"



2006-02 6 NISSAN ALTIMA 3.5L  
 2006-04 6 NISSAN QUEST 3.5L

### 4400

Inlet A: WELDED 3-BOLT FLANGE  
 Outlet A: WELDED 2-BOLT FLANGE  
 Length: 21.50"



2004-00 4 FORD FOCUS 2.0L

### 4402

Inlet A: WELDED 3-BOLT FLANGE  
 Outlet A: LOOSE 3-BOLT FLANGE W/ FLAT FLARE  
 Length: 43"



1995-93 4 SATURN SC2 1.9L  
 1995-93 4 SATURN SL2 1.9L  
 1995-93 4 SATURN SW2 1.9L

### 4403

Inlet A: WELDED 2-BOLT FLANGE  
 Outlet A: WELDED 2-BOLT FLANGE  
 Length: 18.50"



2006-03 4 MITSUBISHI OUTLANDER 2.4L

### 4404

Inlet A: WELDED 2-BOLT FLANGE  
 Outlet A: WELDED 2-BOLT FLANGE  
 Length: 13.75"



2011-09 6 CHEVROLET AVEO 1.6L  
 2011-09 4 CHEVROLET AVEO5 1.6L  
 2010-09 4 PONTIAC G3 1.6L

### 4405

Inlet A: WELDED 3-BOLT FLANGE  
 Outlet A: WELDED 3-BOLT FLANGE  
 Length: 6.88"

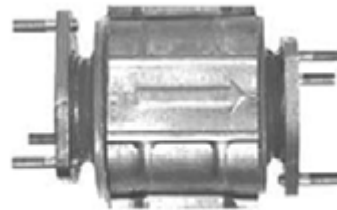

2008-04 4 CHEVROLET AVEO 1.6L  
 2008-07 4 CHEVROLET AVEO5 1.6L  
 2002-99 4 DAEWOO LANOS 1.6L

### 4406

Inlet A: LOOSE 2-BOLT FLANGE W/ SPHERICAL FLARE  
 Inlet B: LOOSE 2-BOLT FLANGE W/ SPHERICAL FLARE  
 Outlet A: 2.165" O.D. PIPE  
 Length: 52.75"



1998-97 8 BMW 540 4.4L  
 1998-96 8 BMW 740 4.4L

# DIRECT FIT

## 4407

Inlet A: LOOSE 2-BOLT FLANGE W/ SPHERICAL FLARE  
 Inlet B: LOOSE 2-BOLT FLANGE W/ SPHERICAL FLARE  
 Outlet A: 2.165" O.D. PIPE  
 Length: 52.75"



1998-97 8 BMW 540 4.4L  
 1998-96 8 BMW 740 4.4L

## 4408

Inlet A: LOOSE 2-BOLT FLANGE W/ 2.25" FLAT FLARE  
 Outlet A: LOOSE 2-BOLT FLANGE W/ 2.25" FLAT FLARE  
 Length: 17.50"



1995-93 4 FORD PROBE 2.0L  
 1994-91 4 INFINITI G20 2.0L  
 2006-03 6 KIA SORENTO 3.5L  
 1989-88 4 MAZDA 323 1.6L  
 1995-93 4 MAZDA 626 2.0L  
 1991-88 6 MAZDA 929 3.0L  
 1995-93 4 MAZDA MX6 2.0L  
 1999-91 6 MITSUBISHI 3000GT 3.0L  
 1993-92 6 MITSUBISHI DIAMANTE 3.0L  
 1983-77 4 NISSAN 200SX All  
 1986-84 4 NISSAN 200SX 1.8L  
 1995-84 4 NISSAN 200SX 2.0L  
 1995 4 NISSAN 200SX 1.6L  
 1994-93 4 NISSAN 240SX 2.4L  
 1979-75 6 NISSAN 280Z, 280ZX All  
 1983-81 6 NISSAN 280Z, 280ZX 2.8L  
 1980-79 4 NISSAN 310 1.4L  
 1981-79 4 NISSAN 510, F-10 All  
 1984-78 6 NISSAN 810 2.4L  
 1990 4 NISSAN AXXESS VAN 2.4L  
 1979-77 4 NISSAN B210, 210 All  
 1982-80 4 NISSAN B210, 210 1.2L  
 1982-80 4 NISSAN B210, 210 1.4L  
 1982-80 4 NISSAN B210, 210 1.5L  
 1994-86 6 NISSAN MAXIMA 3.0L  
 1987-86 4 NISSAN MULTI 2.0L  
 1993-91 4 NISSAN NX All  
 1983-80 4 NISSAN PICKUP 2.0L  
 1983-81 4 NISSAN PICKUP 2.2L  
 1989-86 4 NISSAN PICKUP 2.4L  
 1995-86 6 NISSAN PICKUP 3.0L  
 1990-83 4 NISSAN PULSAR All  
 1986-82 4 NISSAN SENTRA All  
 1990-87 4 NISSAN SENTRA 1.6L  
 1984-82 4 NISSAN STANZA 2.0L

## 4408 (cont.)

1989-85 4 NISSAN STANZA All  
 1992 4 NISSAN STANZA 2.4L  
 1995-88 6 TOYOTA 4 RUNNER 3.0L  
 1991-88 6 TOYOTA CAMRY, (Inc. 1998 & Older SOLARA) 2.5L  
 1992-84 4 TOYOTA PICKUP (ALL MODELS Exc. TACOMA & TUNDRA) 2.4L  
 1995-88 6 TOYOTA PICKUP (ALL MODELS Exc. TACOMA & TUNDRA) 3.0L  
 1993-87 6 TOYOTA SUPRA 3.0L

## 4409

Inlet A: WELDED 6-BOLT FLANGE  
 Outlet A: WELDED 4-BOLT FLANGE  
 Length: 16.50"



2011-06 4 MITSUBISHI ECLIPSE 2.4L  
 2012-04 4 MITSUBISHI GALANT 2.4L

## 4412

Inlet A: WELDED 9-BOLT FLANGE  
 Outlet A: WELDED 2-BOLT FLANGE  
 Length: 18"



2005-01 4 HYUNDAI ACCENT 1.6L

### 4414

Inlet A: WELDED 3-BOLT FLANGE  
 Outlet A: WELDED 3-BOLT FLANGE W/ GASKET STUB  
 Length: 17.88"



- 1994-93 4 CHEVROLET BERETTA 2.3L
- 1995-93 4 CHEVROLET BERETTA 2.2L
- 1995-90 4 CHEVROLET CAVALIER 2.2L
- 1995-93 4 CHEVROLET CORSICA 2.2L
- 1994-90 4 PONTIAC SUNBIRD 2.0L

### 4415

Inlet A: WELDED 4-BOLT FLANGE  
 Outlet A: 2.25" O.D. PIPE  
 Length: 40"



- 2010-07 4 CHRYSLER SEBRING 2.4L
- 2010-08 4 DODGE AVENGER 2.4L
- 2009-07 4 DODGE CALIBER 1.8L
- 2010-07 4 DODGE CALIBER 2.0L
- 2010-07 4 DODGE CALIBER 2.4L
- 2011-07 4 JEEP COMPASS 2.0L
- 2011-07 4 JEEP COMPASS 2.4L
- 2010-07 4 JEEP PATRIOT 2.4L
- 2011-07 4 JEEP PATRIOT 2.0L

### 4418

Inlet A: 1.88" I.D. PIPE  
 Inlet B: 1.88" I.D. PIPE  
 Outlet A: 2.50" I.D. PIPE  
 Length: 36.50"



- 1997-93 6 CHRYSLER CONCORDE 3.5L
- 1995-93 6 CHRYSLER INTREPID 3.5L
- 1997-94 6 CHRYSLER LHS 3.5L
- 1996-94 6 CHRYSLER NEW YORKER 3.5L
- 1997-93 6 DODGE INTREPID 3.5L
- 1996-93 6 EAGLE VISION 3.5L

### 4419

Inlet A: LOOSE 2-BOLT FLANGE W/ 2.25" FEMALE FLARE  
 Outlet A: WELDED 4-BOLT FLANGE  
 Length: 45.50"



- 1993-89 6 BUICK CENTURY 3.3L
- 1993-89 6 OLDSMOBILE CIERA 3.3L

### 4420

Inlet A: LOOSE 2-BOLT FLANGE W/ SPHERICAL FLARE  
 Outlet A: 2.25" O.D. PIPE  
 Length: 47.88"



- 2002-00 6 JAGUAR S-TYPE 3.0L
- 2005-00 6 LINCOLN LS 3.0L

### 4421

Inlet A: LOOSE 2-BOLT FLANGE W/ SPHERICAL FLARE  
 Outlet A: 2.25" O.D. PIPE  
 Length: 45"



- 2002-00 6 JAGUAR S-TYPE 3.0L
- 2005-00 6 LINCOLN LS 3.0L

### 4422

Inlet A: WELDED 3-BOLT FLANGE W/ GASKET STUB  
 Outlet A: WELDED 2-BOLT FLANGE  
 Length: 43.50"



- 1997-93 6 INFINITI J30 3.0L

# DIRECT FIT

## 4423

Inlet A: WELDED 3-BOLT FLANGE W/ GASKET STUB  
 Outlet A: 1.770" O.D. PIPE  
 Length: 45"



1997-93 6 INFINITI J30 3.0L

## 4424

Inlet A: WELDED 3-BOLT FLANGE  
 Outlet A: WELDED 2-BOLT FLANGE  
 Length: 39.25"



2006-05 6 CHEVROLET MALIBU 3.5L  
 2006-05 6 PONTIAC G6 3.5L  
 2007 6 SATURN AURA 3.5L

## 4425

Inlet A: WELDED 3-BOLT FLANGE  
 Inlet B: WELDED 2-BOLT FLANGE  
 Outlet A: WELDED 2-BOLT FLANGE  
 Length: 28.63"



2006-05 6 CHEVROLET MALIBU 3.5L

## 4427

Inlet A: WELDED 4-BOLT FLANGE  
 Outlet A: 2-1/2" O.D. PIPE  
 Length: 34"



2008-05 6 CHRYSLER PACIFICA 3.8L

## 4428

Inlet A: WELDED 2-BOLT FLANGE  
 Outlet A: WELDED 2-BOLT FLANGE  
 Length: 9.75"

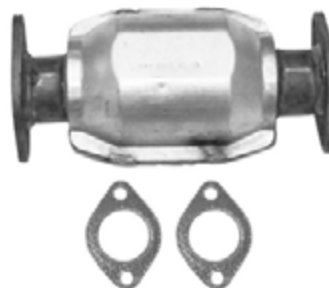

2009-07 4 KIA SPECTRA 2.0L

## 4429

Inlet A: WELDED 2-BOLT FLANGE  
 Outlet A: WELDED 2-BOLT FLANGE  
 Length: 60.50"



2006-05 6 BUICK TERRAZA 3.5L  
 2006-05 6 CHEVROLET UPLANDER 3.5L  
 2006-05 6 PONTIAC MONTANA 3.5L  
 2006-05 6 SATURN RELAY 3.5L  
 2006 6 SATURN RELAY 3.9L

## 4430

Inlet A: WELDED 2-BOLT FLANGE  
 Outlet A: 2-1/2" O.D. PIPE  
 Length: 48.75"



2007-05 8 CHRYSLER 300 5.7L  
 2007-06 8 DODGE CHARGER 5.7L  
 2007-05 8 DODGE MAGNUM 5.7L

### 4431

Inlet A: WELDED 2-BOLT FLANGE  
 Outlet A: 2-1/2" O.D. PIPE  
 Length: 49.75"



2007-05 8 CHRYSLER 300 5.7L  
 2007-06 8 DODGE CHARGER 5.7L  
 2007-05 8 DODGE MAGNUM 5.7L

### 4432

Inlet A: WELDED 2-BOLT FLANGE  
 Outlet A: WELDED 2-BOLT FLANGE W/ GASKET STUB  
 Length: 33.75"



2011-09 4 NISSAN VERSA 1.6L  
 2012-07 4 NISSAN VERSA 1.8L

### 4433

Inlet A: WELDED 3-BOLT FLANGE W/ GASKET STUB  
 Outlet A: WELDED 2-BOLT FLANGE  
 Length: 54"



2000-99 4 MITSUBISHI GALANT 2.4L

### 4434

Inlet A: WELDED 2-BOLT FLANGE  
 Outlet A: WELDED 2-BOLT FLANGE W/ GASKET STUB  
 Length: 29.50"



2008-03 4 MAZDA 6 2.3L

### 4435

Inlet A: WELDED 2-BOLT FLANGE  
 Outlet A: WELDED 3-BOLT FLANGE  
 Length: 27.50"



2001-00 3 HONDA INSIGHT 1.0L

### 4436

Inlet A: WELDED 2-BOLT FLANGE  
 Outlet A: WELDED 3-BOLT FLANGE  
 Length: 30.25"



2011-06 4 HONDA CIVIC 2.0L

### 4437

Inlet A: WELDED 3-BOLT FLANGE  
 Inlet B: WELDED 3-BOLT FLANGE  
 Outlet A: WELDED 2-BOLT FLANGE  
 Length: 42"



2007-03 6 NISSAN MURANO 3.5L

### 4438

Inlet A: WELDED 3-BOLT FLANGE W/ GASKET STUB  
 Inlet B: WELDED 3-BOLT FLANGE W/ GASKET STUB  
 Outlet A: WELDED 2-BOLT FLANGE  
 Length: 41.75"



2006-04 6 NISSAN ALTIMA 3.5L  
 2006-04 6 NISSAN MAXIMA 3.5L  
 2009-04 6 NISSAN QUEST 3.5L

# DIRECT FIT

## 4439

Inlet A: WELDED 3-BOLT FLANGE  
 Outlet A: 1.965" O.D. PIPE  
 Length: 50.25"



- 1999-98 6 AUDI A6 2.8L
- 1999-98 6 VOLKSWAGEN PASSAT 2.8L

## 4440

Inlet A: WELDED 3-BOLT FLANGE  
 Outlet A: WELDED 2-BOLT FLANGE W/ GASKET STUB  
 Length: 42.25"



- 2005-00 6 LEXUS GS300 3.0L
- 2005-01 6 LEXUS IS300 3.0L

## 4441

Inlet A: WELDED 4-BOLT FLANGE  
 Outlet A: 2.50" O.D. PIPE  
 Length: 78.75"



- 2010-08 6 CHRYSLER TOWN & COUNTRY 3.3L
- 2010-08 6 CHRYSLER TOWN & COUNTRY 3.8L
- 2010-08 6 DODGE CARAVAN 3.3L
- 2010-08 6 DODGE CARAVAN 3.8L
- 2010-09 6 VOLKSWAGEN ROUTAN 3.8L

## 4442

Inlet A: WELDED 3-BOLT FLANGE  
 Inlet B: WELDED 3-BOLT FLANGE  
 Outlet A: WELDED 3-BOLT FLANGE  
 Length: 26.75"



- 2010-06 4 SUBARU FORESTER 2.5L
- 2011-06 4 SUBARU IMPREZA 2.5L

## 4443

Inlet A: WELDED 3-BOLT FLANGE  
 Outlet A: WELDED 2-BOLT FLANGE W/ GASKET STUB  
 Length: 53.50"



- 2008-06 4 SUBARU FORESTER 2.5L
- 2007-06 4 SUBARU IMPREZA 2.5L

## 4444

Inlet A: WELDED 3-BOLT FLANGE  
 Outlet A: WELDED 3-BOLT FLANGE  
 Length: 39"



- 2009-08 6 CHEVROLET EQUINOX 3.6L
- 2009-08 6 PONTIAC TORRENT 3.6L
- 2008-07 6 SUZUKI XL-7 3.6L

## 4445

Inlet A: WELDED 3-BOLT FLANGE  
 Outlet A: WELDED 3-BOLT FLANGE  
 Length: 17.75"



- 2009-08 6 CHEVROLET EQUINOX 3.6L
- 2009-08 6 PONTIAC TORRENT 3.6L
- 2008-07 6 SUZUKI XL-7 3.6L

## 4446

Inlet A: WELDED 2-BOLT FLANGE  
 Outlet A: WELDED 4-BOLT FLANGE  
 Length: 43.75"



- 1999-98 6 CHEVROLET LUMINA 3.8L
- 1999-98 6 CHEVROLET MONTE CARLO 3.8L

### 4447

Inlet A: WELDED 4-BOLT FLANGE  
 Outlet A: 2.355" O.D. PIPE  
 Length: 40"



2007-05 5 VOLKSWAGEN JETTA 2.5L  
 2008-06 5 VOLKSWAGEN RABBIT 2.5L

### 4448

Inlet A: WELDED 3-BOLT FLANGE  
 Outlet A: 2.570" O.D. PIPE  
 Length: 27.88"

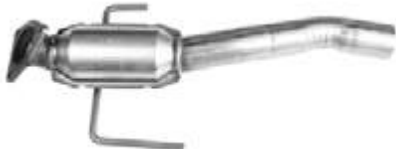

2006-04 6 VOLKSWAGEN TOUAREG 3.2L

### 4449

Inlet A: WELDED 3-BOLT FLANGE  
 Outlet A: WELDED 3-BOLT FLANGE  
 Length: 17"



2002-01 6 ACURA MDX 3.5L  
 2004-03 6 HONDA PILOT 3.5L

### 4450

Inlet A: WELDED 2-BOLT FLANGE  
 Outlet A: WELDED 2-BOLT FLANGE  
 Length: 19"



2002-98 4 MAZDA 626 2.0L

### 4451

Inlet A: WELDED 2-BOLT FLANGE  
 Outlet A: WELDED 2-BOLT FLANGE  
 Length: 19.13"



2002-98 4 MAZDA 626 2.0L  
 2002-98 6 MAZDA 626 2.5L

### 4452

Inlet A: 45 DEGREE FLARE  
 Outlet A: 2.25" O.D. PIPE  
 Length: 46.63"



2001-98 6 CHRYSLER CONCORDE 3.2L  
 2004-02 6 CHRYSLER CONCORDE 3.5L  
 2001-99 6 CHRYSLER LHS 3.5L  
 2001-98 6 DODGE INTREPID 3.2L  
 2004-02 6 DODGE INTREPID 3.5L

### 4453

Inlet A: WELDED 2-BOLT FLANGE  
 Outlet A: 2.25" O.D. PIPE  
 Length: 19.50"



2008-06 6 FORD FUSION 3.0L  
 2006 6 LINCOLN ZEPHYR 3.0L  
 2008-06 6 MERCURY MILAN 3.0L

# DIRECT FIT

## 4454

Inlet A: WELDED 4-BOLT FLANGE  
 Outlet A: WELDED 2-BOLT FLANGE  
 Length: 10.75"



- 2010-07 6 FORD EDGE 3.5L
- 2010-09 6 FORD FLEX 3.5L
- 2010 6 FORD FUSION 3.5L
- 2009-08 6 FORD TAURUS X 3.5L
- 2010-08 6 FORD TAURUS 3.5L
- 2010-09 6 LINCOLN MKS 3.7L
- 2010-07 6 LINCOLN MKX 3.5L
- 2010-07 6 LINCOLN MKZ 3.5L
- 2009-08 6 MERCURY SABLE 3.5L

## 4455

Inlet A: WELDED 4-BOLT FLANGE  
 Outlet A: WELDED 2-BOLT FLANGE W/ GASKET STUB  
 Length: 12.50"



- 2010-07 6 FORD EDGE 3.5L
- 2010-09 6 FORD FLEX 3.5L
- 2010 6 FORD FUSION 3.5L
- 2009-08 6 FORD TAURUS X 3.5L
- 2012-08 6 FORD TAURUS 3.5L
- 2010-09 6 LINCOLN MKS 3.7L
- 2010-07 6 LINCOLN MKX 3.5L
- 2010-07 6 LINCOLN MKZ 3.5L
- 2009-08 6 MERCURY SABLE 3.5L

## 4456

Inlet A: WELDED 4-BOLT FLANGE  
 Outlet A: WELDED 2-BOLT FLANGE  
 Length: 32.50"



- 2007-04 5 VOLVO S40/V40 2.4L
- 2007-05 5 VOLVO V50 2.4L

## 4457

Inlet A: WELDED 2-BOLT FLANGE  
 Outlet A: WELDED 2-BOLT FLANGE  
 Length: 13.50"



- 2002-97 4 MITSUBISHI MIRAGE 1.5L

## 4458

Inlet A: WELDED 3-BOLT FLANGE  
 Outlet A: 2.165" O.D. PIPE  
 Length: 45.50"



- 2004-02 6 AUDI A4 3.0L

## 4459

Inlet A: WELDED 3-BOLT FLANGE  
 Outlet A: 2.165" O.D. PIPE  
 Length: 44.75"



- 2004-02 6 AUDI A4 3.0L



### 4460

Inlet A: WELDED 2-BOLT FLANGE  
 Outlet A: WELDED 2-BOLT FLANGE  
 Length: 51.25"



2003-02 4 NISSAN SENTRA 2.5L

### 4461

Inlet A: WELDED 2-BOLT FLANGE  
 Outlet A: WELDED 2-BOLT FLANGE  
 Length: 16.50"



2009-06 6 HYUNDAI AZERA 3.8L  
 2009-07 6 KIA AMANTI 3.8L

### 4462

Inlet A: WELDED 2-BOLT FLANGE W/ GASKET STUB  
 Outlet A: WELDED 2-BOLT FLANGE  
 Length: 12.50"



1994-93 6 TOYOTA LAND CRUISER 4.5L

### 4463

Inlet A: WELDED 3-BOLT FLANGE W/ GASKET STUB  
 Outlet A: WELDED 2-BOLT FLANGE  
 Length: 41"



2004-99 6 NISSAN FRONTIER 3.3L  
 2004-00 6 NISSAN XTERRA 3.3L

### 4464

Inlet A: WELDED 2-BOLT FLANGE  
 Outlet A: WELDED 2-BOLT FLANGE  
 Length: 57.75"



2007 6 BUICK TERRAZA 3.9L  
 2008-07 6 CHEVROLET UPLANDER 3.9L  
 2008-07 6 PONTIAC MONTANA 3.9L  
 2007 6 SATURN RELAY 3.9L

### 4465

Inlet A: WELDED 2-BOLT FLANGE  
 Outlet A: WELDED 2-BOLT FLANGE  
 Length: 27.38"



2003-01 6 MITSUBISHI MONTERO SPORT 3.0L

### 4466

Inlet A: LOOSE 2-BOLT FLANGE W/ 2.50" CHRYSLER FLARE  
 Outlet A: 2.25" O.D. PIPE  
 Length: 40"



1991-90 6 CHRYSLER TOWN & COUNTRY 3.3L  
 1991-90 6 DODGE CARAVAN 3.3L  
 1991-90 6 PLYMOUTH VOYAGER 3.3L

### 4467

Inlet A: WELDED 3-BOLT FLANGE  
 Outlet A: LOOSE 2-BOLT FLANGE W/ 2" MALE BALL  
 Length: 36.50"



1993-89 4 ASUNA SUNRUNNER All  
 1994-89 4 GEO TRACKER 1.6L  
 1992-89 4 SUZUKI SIDEKICK 1.6L

# DIRECT FIT

## 4469

Inlet A: LOOSE 4-BOLT FLANGE W/ FLAT FLARE  
 Outlet A: 2" O.D. PIPE  
 Length: 25"



- 1985-84 4 JEEP CHEROKEE 2.5L
- 1986-84 6 JEEP CHEROKEE 2.8L
- 1986 6 JEEP COMANCHE 2.8L
- 1985-84 4 JEEP WAGONEER 2.5L
- 1986-84 6 JEEP WAGONEER 2.8L
- 1990-87 6 JEEP WRANGLER 4.2L

## 4470

Inlet A: WELDED 3-BOLT FLANGE  
 Outlet A: 2.7" MALE BALL  
 Length: 51"



- 1997 5 VOLVO 850 2.4L

## 4471

Inlet A: LOOSE 3-BOLT FLANGE W/ FLAT FLARE  
 Outlet A: LOOSE 3-BOLT FLANGE W/ FLAT FLARE  
 Length: 13"



- 1993-90 4 HONDA ACCORD 2.2L
- 1987-85 4 HONDA PRELUDE 2.0L

## 4472

Inlet A: LOOSE 3-BOLT FLANGE W/ FLAT FLARE  
 Outlet A: LOOSE 3-BOLT FLANGE W/ FLAT FLARE  
 Length: 14"



- 1993-91 4 HONDA ACCORD 2.2L

## 4473

Inlet A: WELDED 2-BOLT FLANGE  
 Outlet A: WELDED 4-BOLT FLANGE  
 Length: 44.75"



- 1999-98 6 CHEVROLET LUMINA 3.8L
- 1999-98 6 CHEVROLET MONTE CARLO 3.8L

## 4474

Inlet A: LOOSE 2-BOLT FLANGE W/ FEMALE FLARE  
 Outlet A: 1.965" O.D. PIPE  
 Length: 27.50"



- 2003-00 8 BMW X5 4.4L
- 2003-02 8 BMW X5 4.6L

## 4475

Inlet A: LOOSE 2-BOLT FLANGE W/ FEMALE FLARE  
 Outlet A: 1.965" O.D. PIPE  
 Length: 27.50"



- 2003-00 8 BMW X5 4.4L

## 4476

Inlet A: WELDED 2-BOLT FLANGE W/ GASKET STUB  
 Inlet B: WELDED 2-BOLT FLANGE W/ GASKET STUB  
 Outlet A: WELDED 2-BOLT FLANGE W/ GASKET STUB  
 Length: 35"



- 2001-99 6 LEXUS ES300 3.0L
- 2004-00 6 TOYOTA AVALON 3.0L

### 4477

Inlet A: WELDED 2-BOLT FLANGE  
 Outlet A: WELDED 2-BOLT FLANGE W/ GASKET STUB  
 Length: 103.50"



2004-00 6 TOYOTA AVALON 3.0L

### 4478

Inlet A: 2-BOLT FLANGE W/ 45 DEGREE FLARE  
 Outlet A: 2.125" O.D. PIPE  
 Length: 63.25"



2001-99 8 MERCEDES-BENZ ML430 4.3L

### 4479

Inlet A: 2-BOLT FLANGE W/ 45 DEGREE FLARE  
 Outlet A: 2.125" O.D. PIPE  
 Length: 65"

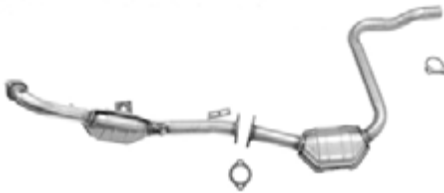

2001-99 8 MERCEDES-BENZ ML430 4.3L

### 4481

Inlet A: WELDED 2-BOLT FLANGE  
 Outlet A: WELDED 2-BOLT FLANGE  
 Length: 13.63"



1998 4 NISSAN 200SX 2.0L  
 2000-98 4 NISSAN SENTRA 2.0L

### 4482

Inlet A: 2.50" I.D. PIPE  
 Outlet A: WELDED 3-BOLT FLANGE  
 Length: 30.50"

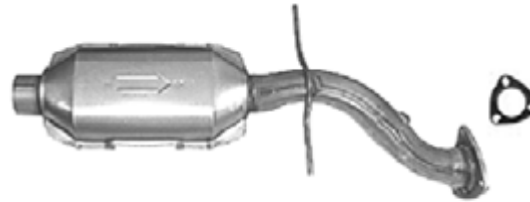

1995 6 CHEVROLET BLAZER S-Series 4.3L  
 1995 6 GMC S-15 JIMMY 4.3L

### 4483

Inlet A: WELDED 3-BOLT FLANGE  
 Outlet A: WELDED 3-BOLT FLANGE  
 Length: 34.50"



2004-03 4 SATURN ION 2.2L

### 4484

Inlet A: WELDED 3-BOLT FLANGE  
 Inlet B: WELDED 3-BOLT FLANGE  
 Outlet A: 2" I.D. PIPE  
 Length: 42.50"



2004-02 6 VOLKSWAGEN JETTA 2.8L

**DIRECT FIT**

**4485**

Inlet A: WELDED 2-BOLT FLANGE  
Inlet B: WELDED 2-BOLT FLANGE  
Outlet A: WELDED 2-BOLT FLANGE  
Length: 51.25"



- 2001 6 HYUNDAI XG300 3.0L
- 2005-02 6 HYUNDAI XG350 3.5L
- 2006-04 6 KIA AMANTI 3.5L

**4486**

Inlet A: WELDED 10-BOLT FLANGE  
Outlet A: WELDED 4-BOLT FLANGE  
Length: 16.50"



- 2005-01 5 VOLVO S60 2.4L
- 2002-01 5 VOLVO S70/V70 2.4L

**4487**

Inlet A: WELDED 9-BOLT FLANGE  
Outlet A: WELDED 3-BOLT FLANGE  
Length: 24"



- 2006-04 5 CHEVROLET COLORADO 3.5L
- 2006-04 5 GMC CANYON 3.5L
- 2006 5 HUMMER H3 3.5L
- 2006 5 ISUZU I-350 3.5L

**4490**

Inlet A: WELDED 2-BOLT FLANGE  
Outlet A: WELDED 2-BOLT FLANGE  
Length: 19.50"



- 2007-05 6 FORD FIVE HUNDRED 3.0L
- 2007-05 6 FORD FREESTYLE 3.0L
- 2007-05 6 MERCURY MONTEGO 3.0L

**4491**

Inlet A: WELDED 2-BOLT FLANGE  
Outlet A: WELDED 2-BOLT FLANGE  
Length: 10.25"



- 2009-07 4 KIA SPECTRA 2.0L

**4492**

Inlet A: WELDED 3-BOLT FLANGE  
Outlet A: WELDED 2-BOLT FLANGE  
Length: 18"



- 2004-00 6 TOYOTA TACOMA 3.4L
- 2004-00 6 TOYOTA TUNDRA 3.4L

### 4493

Inlet A: WELDED 2-BOLT FLANGE  
 Outlet A: 2.24" O.D. PIPE  
 Length: 52"



2004-00 6 TOYOTA TUNDRA 3.4L

### 4494

Inlet A: LOOSE 2-BOLT FLANGE  
 Outlet A: WELDED 3-BOLT FLANGE  
 Length: 27.50"



2004-02 4 ACURA RSX 2.0L

### 4498

Inlet A: WELDED 2-BOLT FLANGE  
 Inlet B: WELDED 2-BOLT FLANGE  
 Outlet A: WELDED 2-BOLT FLANGE  
 Length: 31"



2012-03 6 TOYOTA 4 RUNNER 4.0L  
 2012-07 6 TOYOTA FJ CRUISER 4.0L

### 4499

Inlet A: WELDED 2-BOLT FLANGE  
 Outlet A: WELDED 2-BOLT FLANGE  
 Length: 28"



2012-03 6 TOYOTA 4 RUNNER 4.0L  
 2012-07 6 TOYOTA FJ CRUISER 4.0L

### 4500

Inlet A: WELDED 2-BOLT FLANGE  
 Outlet A: WELDED 2-BOLT FLANGE  
 Length: 17"



2009 4 KIA RONDO 2.4L

### 4501

Inlet A: LOOSE 2-BOLT FLANGE W/ 2" FEMALE FLARE  
 Outlet A: 2.25" O.D. PIPE  
 Length: 38"



1987-86 6 BUICK ELECTRA - (Inc. Park Avenue) 3.8L  
 1987-86 6 BUICK LESABRE All  
 1987-86 6 OLDSMOBILE 98 3.8L  
 1986 6 OLDSMOBILE EIGHTY-EIGHT, DELTA 88 3.0L  
 1987-86 6 OLDSMOBILE EIGHTY-EIGHT, DELTA 88 3.8L  
 1987 6 PONTIAC BONNEVILLE 3.8L

# DIRECT FIT

## 4503

Inlet A: WELDED 3-BOLT FLANGE  
Outlet A: WELDED 3-BOLT FLANGE  
Length: 19"



2007-03 4 HONDA ACCORD 2.4L

## 4504

Inlet A: WELDED 3-BOLT FLANGE  
Outlet A: WELDED 3-BOLT FLANGE  
Length: 13.50"



1998-95 5 ACURA TL 2.5L  
2001-97 4 HONDA PRELUDE 2.2L

## 4505

Inlet A: WELDED 2-BOLT FLANGE  
Outlet A: WELDED 2-BOLT FLANGE  
Length: 22"



2001-00 6 MAZDA MPV VAN 2.5L

## 4506

Inlet A: WELDED 4-BOLT FLANGE  
Outlet A: WELDED 2-BOLT FLANGE  
Length: 51.50"



2000-98 4 ISUZU AMIGO 2.2L  
2000-98 4 ISUZU RODEO 2.2L

## 4507

Inlet A: WELDED 2-BOLT FLANGE  
Inlet B: WELDED 2-BOLT FLANGE  
Outlet A: WELDED 2-BOLT FLANGE W/ GASKET STUB  
Length: 29"



2004-03 8 LEXUS GX470 4.7L  
2004-03 8 TOYOTA 4 RUNNER 4.7L

## 4511

Inlet A: WELDED 2-BOLT FLANGE  
Outlet A: WELDED 3-BOLT FLANGE  
Length: 17.50"

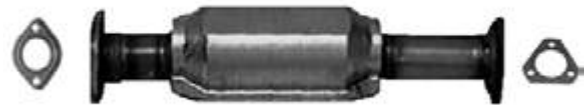

1993-92 4 ACURA INTEGRA 1.7L  
1995-92 4 ACURA INTEGRA 1.8L

## 4512

Inlet A: WELDED 2-BOLT FLANGE  
Outlet A: WELDED 3-BOLT FLANGE  
Length: 16.63"



1991-90 4 ACURA INTEGRA 1.8L

## 4515

Inlet A: 2.25" O.D. PIPE  
Outlet A: 2" O.D. PIPE  
Length: 55.50"



1989-87 6 DODGE DAKOTA 3.9L

### 4516

Inlet A: WELDED 2-BOLT FLANGE W/ FEMALE FLARE  
 Outlet A: 2.50" O.D. PIPE  
 Length: 23.50"



1992-89	8	CADILLAC ALLANTE 4.5L
1993	8	CADILLAC ALLANTE 4.6L
1995-94	8	CADILLAC DEVILLE 4.6L
1990	8	CADILLAC ELDORADO 4.5L
1992-91	8	CADILLAC ELDORADO 4.9L
1995-93	8	CADILLAC ELDORADO 4.6L
1990	8	CADILLAC SEVILLE 4.5L
1992-91	8	CADILLAC SEVILLE 4.9L
1995-93	8	CADILLAC SEVILLE 4.6L

### 4516G

Inlet A: WELDED 2-BOLT FLANGE W/ FEMALE FLARE  
 Outlet A: 2.63" O.D. PIPE  
 Length: 23.50"



1990	8	CADILLAC ELDORADO 4.5L
1992-91	8	CADILLAC ELDORADO 4.9L
1995-93	8	CADILLAC ELDORADO 4.6L
1990	8	CADILLAC SEVILLE 4.5L
1992-91	8	CADILLAC SEVILLE 4.9L
1994-93	8	CADILLAC SEVILLE 4.6L

### 4517

Inlet A: 2.50" I.D. PIPE  
 Outlet A: LOOSE 4-BOLT GM FLANGE W/ 2.50" MALE BALL  
 Length: 20.50"



1995-93	6	CHEVROLET CAMARO 3.4L
1995-93	6	PONTIAC FIREBIRD, TRANS AM, FORMULA 3.4L

### 4520

Inlet A: LOOSE 2-BOLT FLANGE W/ FEMALE FLARE  
 Outlet A: LOOSE 2-BOLT FLANGE W/ FLAT FLARE  
 Length: 30.50"



1994-92	8	FORD CROWN VICTORIA (Inc. Police, Taxi, Station Wagon) 4.6L
1994-91	8	LINCOLN TOWN CAR 4.6L
1994-92	8	MERCURY GRAND MARQUIS FULL SIZE 4.6L

### 4521

Inlet A: LOOSE 2-BOLT FLANGE W/ FEMALE FLARE  
 Outlet A: LOOSE 2-BOLT FLANGE W/ FLAT FLARE  
 Length: 31"



1994-92	8	FORD CROWN VICTORIA (Inc. Police, Taxi, Station Wagon) 4.6L
1994-91	8	LINCOLN TOWN CAR 4.6L
1994-92	8	MERCURY GRAND MARQUIS FULL SIZE 4.6L

### 4524

Inlet A: LOOSE 2-BOLT FLANGE W/ FEMALE FLARE  
 Outlet A: 2.50" O.D. PIPE  
 Length: 37.50"



1990-88	8	CADILLAC COMMERCIAL CHASSIS - FUNERAL COACH, LIMOUSINE 4.5L
1987-86	8	CADILLAC FLEETWOOD 4.1L
1990-88	8	CADILLAC FLEETWOOD 4.5L

### 4526

Inlet A: LOOSE 2-BOLT FLANGE W/ FEMALE FLARE  
 Outlet A: 2" O.D. PIPE  
 Length: 25.75"



1994-92	6	FORD TEMPO 3.0L
---------	---	-----------------

**DIRECT FIT**

**4526 (cont.)**

1994-92 6 MERCURY TOPAZ 3.0L

**4529**

Inlet A: WELDED 2-BOLT FLANGE  
Outlet A: WELDED 2-BOLT FLANGE  
Length: 14.63"



1993-90 4 MAZDA MIATA, MX5 1.6L

**4530**

Inlet A: WELDED 2-BOLT FLANGE  
Outlet A: WELDED 2-BOLT FLANGE  
Length: 25.50"



1994-90 4 MAZDA PROTÉGÉ 1.8L

**4531**

Inlet A: WELDED 2-BOLT FLANGE  
Outlet A: WELDED 2-BOLT FLANGE W/ GASKET STUB  
Length: 36"



2009-08 8 BUICK LACROSSE 5.3L  
2009-06 8 CHEVROLET IMPALA FWD 5.3L  
2007-06 8 CHEVROLET MONTE CARLO 5.3L  
2008-05 8 PONTIAC GRAND PRIX 5.3L

**4532**

Inlet A: WELDED 5-BOLT FLANGE  
Outlet A: WELDED 2-BOLT FLANGE  
Length: 22"



2003-01 4 TOYOTA HIGHLANDER 2.4L

**4533**

Inlet A: WELDED 3-BOLT FLANGE  
Outlet A: WELDED 3-BOLT FLANGE  
Length: 10"



2006-03 6 ACURA MDX 3.5L  
2008-04 6 ACURA TL 3.2L  
2007-03 6 HONDA ACCORD 3.0L  
2010-05 6 HONDA ODYSSEY 3.5L  
2008-05 6 HONDA PILOT 3.5L  
2008-06 6 HONDA RIDGELINE 3.5L

**4535**

Inlet A: WELDED 4-BOLT FLANGE  
Outlet A: 2.25" O.D. PIPE  
Length: 66.25"



2008-06 4 VOLKSWAGEN PASSAT 2.0L



### 4539

Inlet A: WELDED 10-BOLT FLANGE  
 Outlet A: WELDED 3-BOLT FLANGE  
 Length: 17.50"



2008-04	4	CHEVROLET MALIBU 2.2L
2010-08	4	CHEVROLET MALIBU 2.4L
2010-06	4	PONTIAC G6 2.4L
2009-07	4	SATURN AURA 2.4L

### 4540

Inlet A: LOOSE 2-BOLT FLANGE W/ 3" FLAT FLARE  
 Outlet A: LOOSE 2-BOLT FLANGE W/ 3" FLAT FLARE  
 Length: 17.25"



1995-93	6	FORD PROBE 2.5L
1995-93	6	MAZDA 626 2.5L
1995-93	6	MAZDA MX6 2.5L

### 4541

Inlet A: WELDED 2-BOLT FLANGE  
 Inlet B: WELDED 2-BOLT FLANGE  
 Outlet A: WELDED 2-BOLT FLANGE  
 Length: 78"



2004	6	HYUNDAI SANTA FE 3.5L
------	---	-----------------------

### 4542

Inlet A: WELDED 3-BOLT FLANGE  
 Outlet A: WELDED 2-BOLT FLANGE  
 Length: 28.25"



2008	6	CHEVROLET MALIBU 3.6L
2008-07	6	PONTIAC G6 3.6L
2008-07	6	SATURN AURA 3.6L

### 4543

Inlet A: WELDED 3-BOLT FLANGE  
 Inlet B: WELDED 2-BOLT FLANGE  
 Outlet A: WELDED 2-BOLT FLANGE  
 Length: 22"



2008	6	CHEVROLET MALIBU 3.6L
2008-07	6	PONTIAC G6 3.6L
2008-07	6	SATURN AURA 3.6L

### 4544

Inlet A: WELDED 5-BOLT FLANGE  
 Outlet A: WELDED 2-BOLT FLANGE W/ GASKET STUB  
 Length: 20.13"



2009-07	4	MAZDA CX-7 2.3L
---------	---	-----------------

# DIRECT FIT

## 4545

Inlet A: WELDED 3-BOLT FLANGE W/ GASKET STUB  
 Outlet A: WELDED 2-BOLT FLANGE  
 Length: 105"



2009-07 4 MAZDA CX-7 2.3L

## 4546

Inlet A: WELDED 2-BOLT FLANGE  
 Outlet A: WELDED 2-BOLT FLANGE W/ 1.85" O.D. GASKET OUTLET  
 Length: 19"



2007-04 6 CADILLAC CTS 3.6L

2007-05 6 CADILLAC CTS 2.8L

## 4547

Inlet A: WELDED 2-BOLT FLANGE  
 Outlet A: WELDED 2-BOLT FLANGE W/ 1.85" O.D. GASKET OUTLET  
 Length: 19.50"



2007-04 6 CADILLAC CTS 3.6L

2007-05 6 CADILLAC CTS 2.8L

## 4550

Inlet A: WELDED 3-BOLT FLANGE W/ DUAL GASKET STUB  
 Outlet A: WELDED 2-BOLT FLANGE  
 Length: 35.75"

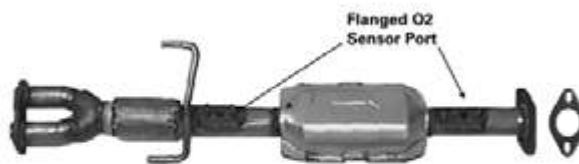

1995-91 4 TOYOTA PREVIA VAN 2.4L

## 4551

Inlet A: LOOSE 2-BOLT FLANGE W/ FEMALE FLARE  
 Inlet B: LOOSE 2-BOLT FLANGE W/ FEMALE FLARE  
 Outlet A: WELDED 2-BOLT FLANGE W/ GASKET STUB  
 Length: 44.50"



1996-95 6 FORD WINDSTAR 3.8L

## 4552

Inlet A: 2.50" I.D. PIPE  
 Outlet A: 2.50" O.D. PIPE  
 Length: 59"



1995-94 6 DODGE DAKOTA 3.9L

1995-94 8 DODGE DAKOTA 5.2L

## 4553

Inlet A: WELDED 2-BOLT FLANGE  
 Outlet A: WELDED 2-BOLT FLANGE  
 Length: 85"



2006 4 MAZDA MIATA, MX5 2.0L

## 4555

Inlet A: 2.25" I.D. PIPE  
 Outlet A: 2.25" O.D. PIPE  
 Length: 23.88"



1995-93 4 JEEP CHEROKEE 2.5L  
 1995-93 6 JEEP CHEROKEE 4.0L  
 1995-93 6 JEEP GRAND CHEROKEE/GRAND WAGONEER 4.0L

## 4556

Inlet A: LOOSE 2-BOLT FLANGE W/ 2.50" FEMALE FLARE  
 Inlet B: LOOSE 2-BOLT FLANGE W/ 2.50" FEMALE FLARE  
 Outlet A: WELDED 3-BOLT FLANGE  
 Length: 30.50"



2005 6 FORD RANGER 4.0L

## 4557

Inlet A: WELDED 3-BOLT FLANGE  
 Outlet A: WELDED 2-BOLT FLANGE  
 Length: 44"



2009-05 5 VOLVO S60 2.4L  
 2009-05 5 VOLVO S60 2.5L  
 2007-05 5 VOLVO S70/V70 2.5L  
 2006-04 5 VOLVO S80 2.5L

## 4558

Inlet A: WELDED 8-BOLT FLANGE  
 Outlet A: WELDED 2-BOLT FLANGE  
 Length: 27"



2006-01 6 BMW 330 3.0L

## 4559

Inlet A: WELDED 8-BOLT FLANGE  
 Outlet A: WELDED 2-BOLT FLANGE  
 Length: 17"



2006-01 6 BMW 330 3.0L

## 4560

Inlet A: WELDED 2-BOLT FLANGE  
 Outlet A: WELDED 2-BOLT FLANGE  
 Length: 34.75"



2011-03 4 HONDA ELEMENT 2.4L

## 4561

Inlet A: WELDED 2-BOLT FLANGE  
 Inlet B: WELDED 2-BOLT FLANGE  
 Outlet A: 2.47" I.D. PIPE  
 Length: 47.25"



2003-01 8 LEXUS LS430 4.3L

# DIRECT FIT

## 4562

Inlet A: WELDED 7-BOLT FLANGE  
 Outlet A: WELDED 2-BOLT FLANGE  
 Length: 34"



2009-07 4 MAZDA 3 2.0L

## 4563

Inlet A: WELDED 2-BOLT FLANGE  
 Outlet A: 2.25" O.D. PIPE  
 Length: 17.75"



2009-07 4 MAZDA 3 2.0L  
 2009-07 4 MAZDA 3 2.3L

## 4564

Inlet A: WELDED 3-BOLT FLANGE  
 Outlet A: WELDED 2-BOLT FLANGE  
 Length: 47"



2008-04 R MAZDA RX-8 1.3L

## 4565

Inlet A: 2-BOLT FLANGE W/ FEMALE FLARE  
 Inlet B: 2-BOLT FLANGE W/ FEMALE FLARE  
 Outlet A: LOOSE 2-BOLT FLANGE W/ 2.25" MALE BALL  
 Length: 56.88"

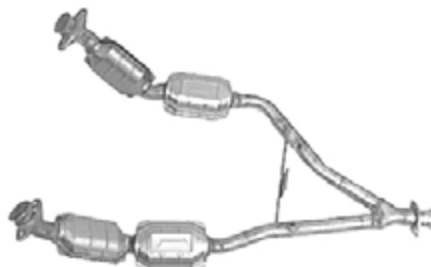

1998-96 6 FORD MUSTANG 3.8L

## 4566

Inlet A: LOOSE 2-BOLT FLANGE W/ SPHERICAL FLARE  
 Inlet B: LOOSE 2-BOLT FLANGE W/ SPHERICAL FLARE  
 Outlet A: LOOSE 2-BOLT FLANGE W/ 2.65" MALE BALL  
 Length: 56"

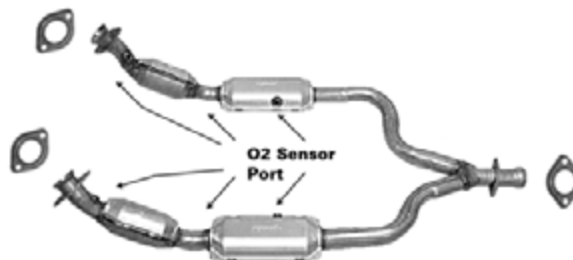

2004-99 6 FORD MUSTANG 3.8L  
 2004 6 FORD MUSTANG 3.9L

## 4567

Inlet A: 2.50" FEMALE FLARE  
 Inlet B: 2.50" FEMALE FLARE  
 Outlet A: 2" O.D. PIPE  
 Outlet B: 2" O.D. PIPE  
 Length: 54"



1996-94 12 JAGUAR XJ12 6.0L

### 4569

Inlet A: LOOSE 2-BOLT FLANGE  
 Inlet B: LOOSE 2-BOLT FLANGE  
 Outlet A: 2.50" FLAT FLARE  
 Length: 31.50"



1996-94 12 JAGUAR XJ12 6.0L

### 4570

Inlet A: LOOSE 2-BOLT FLANGE W/ FEMALE FLARE  
 Outlet A: LOOSE 2-BOLT FLANGE W/ 2" MALE BALL  
 Length: 51.25"



1993-87 4 FORD MUSTANG 2.3L

### 4572

Inlet A: WELDED 3-BOLT FLANGE  
 Outlet A: WELDED 2-BOLT FLANGE  
 Length: 12.50"



2011-08 6 BUICK ENCLAVE 3.6L  
 2011-09 6 CHEVROLET TRAVERSE 3.6L  
 2011-07 6 GMC ACADIA 3.6L  
 2010-07 6 SATURN OUTLOOK 3.6L

### 4573

Inlet A: WELDED 3-BOLT FLANGE  
 Outlet A: WELDED 2-BOLT FLANGE  
 Length: 15.50"



2011-08 6 BUICK ENCLAVE 3.6L  
 2011-09 6 CHEVROLET TRAVERSE 3.6L  
 2011-07 6 GMC ACADIA 3.6L  
 2010-07 6 SATURN OUTLOOK 3.6L

### 4574

Inlet A: WELDED 3-BOLT FLANGE  
 Outlet A: WELDED 2-BOLT FLANGE  
 Length: 27.50"



2004 6 CHEVROLET MALIBU 3.5L

### 4575

Inlet A: WELDED 3-BOLT FLANGE  
 Outlet A: WELDED 2-BOLT FLANGE  
 Length: 15.50"



2004 6 CHEVROLET MALIBU 3.5L

**DIRECT FIT**

**4576**

Inlet A: WELDED 3-BOLT FLANGE  
Outlet A: 2.50" MALE BALL  
Length: 58"



1999-98 5 VOLVO S70/V70 2.4L

**4577**

Inlet A: LOOSE 2-BOLT FLANGE  
Inlet B: LOOSE 2-BOLT FLANGE  
Outlet A: 2.50" O.D. PIPE  
Length: 41"



2004 6 DODGE DURANGO 3.7L  
2004 8 DODGE DURANGO 4.7L

**4578**

Inlet A: WELDED 3-BOLT FLANGE  
Outlet A: WELDED 2-BOLT FLANGE  
Length: 45.25"



2005-04 4 SUBARU LEGACY 2.5L  
2005-04 4 SUBARU OUTBACK 2.5L

**4579**

Inlet A: LOOSE 2-BOLT FLANGE W/ SPHERICAL FLARE  
Outlet A: 2" I.D. PIPE  
Length: 69.75"



2002-98 8 MERCEDES-BENZ E430 4.3L

**4582**

Inlet A: LOOSE 2-BOLT FLANGE W/ SPHERICAL FLARE  
Inlet B: LOOSE 2-BOLT FLANGE W/ SPHERICAL FLARE  
Outlet A: WELDED 2-BOLT FLANGE  
Length: 50"



2010-06 8 FORD EXPLORER 4.6L  
2010-06 8 MERCURY MOUNTAINEER 4.6L

**4584**

Inlet A: WELDED 2-BOLT FLANGE  
Outlet A: WELDED 2-BOLT FLANGE W/ GASKET STUB  
Length: 21"



2011-08 6 CADILLAC CTS 3.6L  
2009 6 CADILLAC SRX 3.6L  
2011-08 6 CADILLAC STS 3.6L

### 4585

Inlet A: WELDED 2-BOLT FLANGE  
 Outlet A: WELDED 2-BOLT FLANGE W/ GASKET STUB  
 Length: 18.50"



2011-08 6 CADILLAC CTS 3.6L  
 2009 6 CADILLAC SRX 3.6L  
 2011-08 6 CADILLAC STS 3.6L

### 4586

Inlet A: WELDED 2-BOLT FLANGE  
 Outlet A: WELDED 3-BOLT FLANGE  
 Length: 16.50"



1995-94 4 HONDA ACCORD 2.2L

### 4587

Inlet A: WELDED 3-BOLT FLANGE  
 Outlet A: WELDED 2-BOLT FLANGE  
 Length: 21"

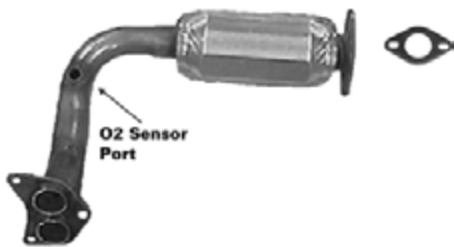

1998-94 6 MERCURY VILLAGER 3.0L  
 1998-94 6 NISSAN QUEST 3.0L

### 4588

Inlet A: WELDED 2-BOLT FLANGE  
 Outlet A: WELDED 2-BOLT FLANGE  
 Length: 16"



1998-93 6 MERCURY VILLAGER 3.0L  
 2002-99 6 MERCURY VILLAGER 3.3L  
 1994-90 6 NISSAN PATHFINDER 3.0L  
 1997-95 4 NISSAN PICKUP 2.4L  
 1998-93 6 NISSAN QUEST 3.0L  
 2002-99 6 NISSAN QUEST 3.3L

### 4589

Inlet A: LOOSE 2-BOLT FLANGE W/ FEMALE FLARE  
 Outlet A: WELDED 3-BOLT FLANGE  
 Length: 43.50"



1993-90 6 BUICK SKYLARK 3.3L  
 1993-92 6 OLDSMOBILE ACHIEVA 3.3L  
 1991-90 6 OLDSMOBILE CALAIS 3.3L  
 1993-92 6 PONTIAC GRAND AM 3.3L

### 4590

Inlet A: WELDED 2-BOLT FLANGE  
 Inlet B: WELDED 2-BOLT FLANGE  
 Outlet A: WELDED 2-BOLT FLANGE  
 Length: 74"



2000-98 6 TOYOTA SIENNA 3.0L

# DIRECT FIT

## 4592

Inlet A: LOOSE 2-BOLT FLANGE W/ FEMALE FLARE  
 Inlet B: LOOSE 2-BOLT FLANGE W/ FEMALE FLARE  
 Outlet A: LOOSE 2-BOLT FLANGE W/ 2.50" MALE BALL  
 Length: 50"

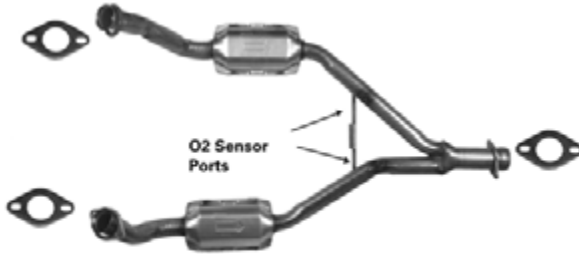

1995-94 6 FORD MUSTANG 3.8L

## 4593

Inlet A: LOOSE 2-BOLT FLANGE W/ FEMALE FLARE  
 Inlet B: LOOSE 2-BOLT FLANGE W/ FEMALE FLARE  
 Outlet A: 2.25" O.D. PIPE  
 Length: 51.25"

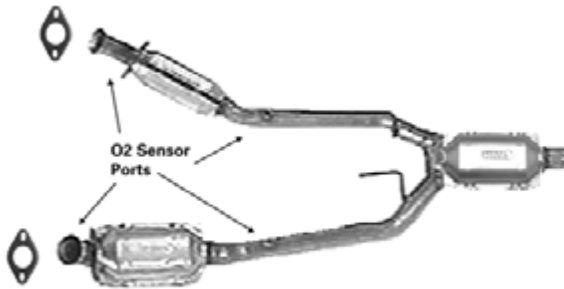

1995-94 8 FORD THUNDERBIRD 4.6L  
 1995-94 8 MERCURY COUGAR 4.6L

## 4594

Inlet A: WELDED 2-BOLT FLANGE  
 Outlet A: WELDED 3-BOLT FLANGE  
 Length: 25"



2008-07 4 HONDA FIT 1.5L

## 4595

Inlet A: WELDED 3-BOLT FLANGE  
 Outlet A: WELDED 3-BOLT FLANGE W/ GASKET STUB  
 Length: 20.25"



1991-90 4 BUICK SKYLARK 2.5L  
 1991-90 4 OLDSMOBILE CALAIS 2.5L  
 1991-90 4 PONTIAC GRAND AM 2.5L

## 4596

Inlet A: 1.88" I.D. PIPE  
 Inlet B: 1.88" I.D. PIPE  
 Outlet A: 2" I.D. PIPE  
 Length: 23.75"



1996-93 6 CHRYSLER CONCORDE 3.3L  
 1995-93 6 CHRYSLER INTREPID 3.3L  
 1997-93 6 DODGE INTREPID 3.3L  
 1997-93 6 EAGLE VISION 3.3L

## 4596G

Inlet A: 1.88" I.D. PIPE  
 Inlet B: 1.88" I.D. PIPE  
 Outlet A: 2" O.D. PIPE  
 Length: 23.75"



1996-93 6 CHRYSLER CONCORDE 3.3L  
 1995-93 6 CHRYSLER INTREPID 3.3L  
 1997-93 6 DODGE INTREPID 3.3L  
 1997-93 6 EAGLE VISION 3.3L



### 4598

Inlet A: LOOSE 2-BOLT FLANGE W/ 2.25" FEMALE FLARE  
 Outlet A: LOOSE 2-BOLT FLANGE W/ 2" FLAT FLARE  
 Length: 33.50"



- |      |   |   |
|------|---|---|
| 1995 | 8 | FORD CROWN VICTORIA (Inc. Police, Taxi, Station Wagon) 4.6L |
| 1995 | 8 | LINCOLN TOWN CAR 4.6L                                       |
| 1995 | 8 | MERCURY GRAND MARQUIS FULL SIZE 4.6L                        |

### 4599

Inlet A: LOOSE 2-BOLT FLANGE W/ 2.25" FEMALE FLARE  
 Outlet A: LOOSE 2-BOLT FLANGE W/ 2" FLAT FLARE  
 Length: 32.50"



- |      |   |   |
|------|---|---|
| 1995 | 8 | FORD CROWN VICTORIA (Inc. Police, Taxi, Station Wagon) 4.6L |
| 1995 | 8 | LINCOLN TOWN CAR 4.6L                                       |
| 1995 | 8 | MERCURY GRAND MARQUIS FULL SIZE 4.6L                        |

### 4600

Inlet A: WELDED 2-BOLT FLANGE  
 Outlet A: WELDED 2-BOLT FLANGE W/ GASKET STUB  
 Length: 28"



- |         |   |              |
|---------|---|--------------|
| 2008-06 | 6 | MAZDA 6 3.0L |
|---------|---|--------------|

### 4603

Inlet A: WELDED 2-BOLT FLANGE  
 Outlet A: WELDED 2-BOLT FLANGE  
 Length: 16.50"



- |         |   |                    |
|---------|---|--------------------|
| 1999-95 | 4 | DODGE AVENGER 2.0L |
|---------|---|--------------------|

### 4604

Inlet A: LOOSE 2-BOLT FLANGE W/ FEMALE FLARE  
 Outlet A: WELDED 2-BOLT FLANGE  
 Length: 22.25"

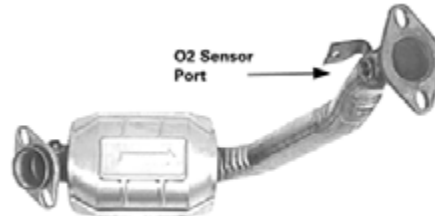

- |      |   |                     |
|------|---|---------------------|
| 1996 | 4 | FORD ESCORT 1.9L    |
| 1996 | 4 | MERCURY TRACER 1.9L |

### 4605

Inlet A: LOOSE 3-BOLT FLANGE W/ 45 DEGREE FLARE  
 Outlet A: 2.320" O.D. PIPE  
 Length: 28.75"



- |         |   |                |
|---------|---|----------------|
| 1992-85 | 4 | VOLVO 740 2.3L |
| 1990-84 | 4 | VOLVO 760 2.3L |
| 1990-87 | 6 | VOLVO 760 2.8L |
| 1995-91 | 4 | VOLVO 940 2.3L |

### 4606

Inlet A: WELDED 3-BOLT FLANGE  
 Inlet B: WELDED 3-BOLT FLANGE  
 Outlet A: WELDED 2-BOLT FLANGE  
 Length: 43"



- |         |   |                    |
|---------|---|--------------------|
| 2008-07 | 6 | NISSAN ALTIMA 3.5L |
|---------|---|--------------------|

### 4607

Inlet A: WELDED 2-BOLT FLANGE  
 Outlet A: WELDED 2-BOLT FLANGE  
 Length: 33"



- |         |   |                  |
|---------|---|------------------|
| 2014-09 | 4 | NISSAN CUBE 1.8L |
|---------|---|------------------|

**DIRECT FIT**

**4608**

Inlet A: WELDED 2-BOLT FLANGE  
Outlet A: WELDED 2-BOLT FLANGE  
Length: 47.50"



2011 4 HYUNDAI SONATA 2.4L

**4609**

Inlet A: WELDED 2-BOLT FLANGE  
Outlet A: 2" O.D. PIPE  
Length: 27.25"



2009-06 4 MITSUBISHI ECLIPSE 2.4L

**4610**

Inlet A: LOOSE 2-BOLT FLANGE W/ FEMALE FLARE  
Inlet B: LOOSE 2-BOLT FLANGE W/ FEMALE FLARE  
Outlet A: LOOSE 2-BOLT FLANGE W/ 2.50" MALE BALL  
Length: 60.50"

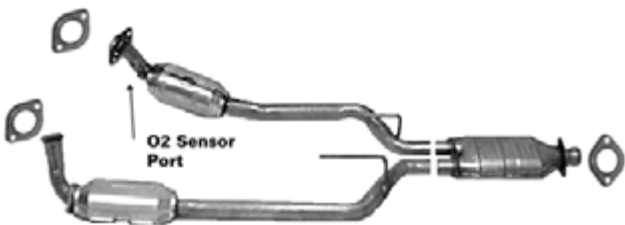

1993-89 6 FORD THUNDERBIRD 3.8L

**4611**

Inlet A: WELDED 9-BOLT FLANGE  
Outlet A: WELDED 2-BOLT FLANGE  
Length: 18"



2010-06 4 HYUNDAI ACCENT 1.6L  
2010-06 4 KIA RIO 1.6L  
2010-06 4 KIA RIO5 1.6L

**4612**

Inlet A: LOOSE 2-BOLT FLANGE W/ FEMALE FLARE  
Outlet A: WELDED 2-BOLT FLANGE  
Length: 22.25"



1995-91 4 FORD ESCORT 1.9L  
1995-91 4 MERCURY TRACER 1.9L

**4615**

Inlet A: WELDED 2-BOLT FLANGE W/ GASKET STUB  
Inlet B: WELDED 2-BOLT FLANGE W/ GASKET STUB  
Outlet A: WELDED 2-BOLT FLANGE  
Length: 46"



2004-03 8 INFiniti M45 4.5L  
2006-02 8 INFiniti Q45 4.5L

**4616**

Inlet A: WELDED 2-BOLT FLANGE  
Outlet A: 2" O.D. PIPE  
Length: 59"



2004-03 6 MERCEDES-BENZ C240 2.6L  
2004-03 6 MERCEDES-BENZ C320 3.2L

**4617**

Inlet A: WELDED 2-BOLT FLANGE  
Inlet B: LOOSE 2-BOLT FLANGE  
Outlet A: LOOSE 3-BOLT FLANGE W/ FLAT FLARE  
Length: 65.50"



2004-03 6 MERCEDES-BENZ C240 2.6L  
2004-03 6 MERCEDES-BENZ C320 3.2L

### 4618

Inlet A: WELDED 2-BOLT FLANGE  
 Outlet A: WELDED 2-BOLT FLANGE  
 Length: 16"



2007-04 6 CADILLAC SRX 3.6L  
 2007-05 6 CADILLAC STS 3.6L

### 4619

Inlet A: WELDED 2-BOLT FLANGE  
 Outlet A: WELDED 2-BOLT FLANGE  
 Length: 16"



2007-04 6 CADILLAC SRX 3.6L  
 2007-05 6 CADILLAC STS 3.6L

### 4620

Inlet A: LOOSE 2-BOLT FLANGE W/ FEMALE FLARE  
 Outlet A: WELDED 2-BOLT FLANGE  
 Length: 61"



1989-86 4 SUBARU COUPE - 3 Dr. 1.8L  
 1994-90 4 SUBARU LOYALE 1.8L  
 1989-85 4 SUBARU SEDAN - 4 Dr. 1.8L  
 1989-85 4 SUBARU STATION WAGON 1.8L  
 1990-85 4 SUBARU XT 1.8L

### 4621

Inlet A: WELDED 3-BOLT FLANGE  
 Outlet A: WELDED 2-BOLT FLANGE  
 Length: 37"



2008 4 CHEVROLET HHR 2.4L

### 4622

Inlet A: WELDED 2-BOLT FLANGE  
 Outlet A: WELDED 3-BOLT FLANGE  
 Length: 32"



2009-07 4 HONDA CRV 2.4L

### 4623

Inlet A: 2" I.D. PIPE  
 Outlet A: LOOSE GM FLANGE W/ 2.25" MALE BALL  
 Length: 17.25"



1995-94 4 CHEVROLET LLV 2.2L  
 1995-94 4 CHEVROLET S-Series (2WD), T-Series (4WD)  
 PICKUP 2.2L  
 1995-94 4 GMC S-Series (2WD), T-Series (4WD) PICKUP  
 (SONOMA) 2.2L

### 4624

Inlet A: WELDED 3-BOLT FLANGE  
 Outlet A: WELDED 2-BOLT FLANGE  
 Length: 46.75"



2004-01 6 SUBARU OUTBACK 3.0L

# DIRECT FIT

## 4625

Inlet A: WELDED 3-BOLT FLANGE  
 Inlet B: WELDED 2-BOLT FLANGE  
 Outlet A: WELDED 2-BOLT FLANGE  
 Length: 57"



2004-01 6 SUBARU OUTBACK 3.0L

## 4626

Inlet A: LOOSE 2-BOLT FLANGE W/ SPHERICAL FLARE  
 Inlet B: LOOSE 2-BOLT FLANGE W/ SPHERICAL FLARE  
 Outlet A: WELDED 2-BOLT FLANGE  
 Length: 46"



2006 6 JEEP COMMANDER 4.7L  
 2006-05 8 JEEP GRAND CHEROKEE/GRAND WAGONEER 4.7L

## 4627

Inlet A: LOOSE 2-BOLT FLANGE W/ FEMALE FLARE  
 Outlet A: LOOSE 2-BOLT FLANGE W/ GASKET STUB  
 Length: 39.25"



1994-86 4 FORD RANGER 2.3L  
 1994 4 MAZDA B-Series PICKUP 2.3L

## 4628

Inlet A: 2.50" I.D. PIPE  
 Outlet A: WELDED 3-BOLT FLANGE  
 Length: 26.38"

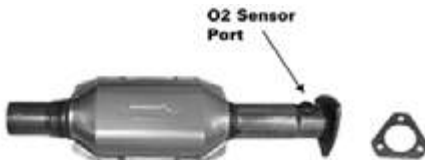

1995 6 CHEVROLET S-Series (2WD), T-Series (4WD) PICKUP 4.3L  
 1995 6 GMC S-Series (2WD), T-Series (4WD) PICKUP (SONOMA) 4.3L

## 4629

Inlet A: LOOSE 2-BOLT FLANGE W/ SPECIAL FLARE  
 Outlet A: WELDED 4-BOLT FLANGE  
 Length: 46"



1995-94 6 BUICK REGAL 3.1L  
 1995-94 6 CHEVROLET LUMINA 3.1L  
 1995 6 CHEVROLET MONTE CARLO 3.1L  
 1995-94 6 OLDSMOBILE CUTLASS 3.1L  
 1995-94 6 PONTIAC GRAND PRIX 3.1L

## 4630

Inlet A: WELDED 3-BOLT FLANGE  
 Outlet A: WELDED 2-BOLT FLANGE  
 Length: 13"



2010-05 6 NISSAN FRONTIER 4.0L  
 2010-05 6 NISSAN PATHFINDER 4.0L  
 2010-05 6 NISSAN XTERRA 4.0L

## 4631

Inlet A: WELDED 3-BOLT FLANGE  
 Outlet A: WELDED 2-BOLT FLANGE  
 Length: 12.50"



2010-05 6 NISSAN FRONTIER 4.0L

## 4631 (cont.)

2010-05 6 NISSAN PATHFINDER 4.0L  
 2010-05 6 NISSAN XTERRA 4.0L

## 4632

Inlet A: WELDED 2-BOLT FLANGE  
 Outlet A: WELDED 2-BOLT FLANGE  
 Length: 27"



2010-05 6 NISSAN FRONTIER 4.0L  
 2010-05 6 NISSAN PATHFINDER 4.0L  
 2010-05 6 NISSAN XTERRA 4.0L

## 4633

Inlet A: WELDED 2-BOLT FLANGE  
 Outlet A: WELDED 2-BOLT FLANGE  
 Length: 27"



2010-05 6 NISSAN FRONTIER 4.0L  
 2010-05 6 NISSAN PATHFINDER 4.0L  
 2010-05 6 NISSAN XTERRA 4.0L

## 4634

Inlet A: LOOSE 2-BOLT FLANGE W/ SPHERICAL FLARE  
 Inlet B: LOOSE 2-BOLT FLANGE W/ SPHERICAL FLARE  
 Outlet A: WELDED 4-BOLT FLANGE  
 Length: 53"



2007-05 8 FORD F-250 PICKUP 3/4 TON 5.4L

## 4635

Inlet A: LOOSE 2-BOLT FLANGE W/ FEMALE FLARE  
 Outlet A: WELDED 2-BOLT FLANGE  
 Length: 35"



2004-01 6 CHEVROLET TRACKER 2.5L

## 4636

Inlet A: WELDED 3-BOLT FLANGE  
 Outlet A: WELDED 2-BOLT FLANGE  
 Length: 42.50"



2011-07 8 TOYOTA TUNDRA 5.7L

## 4637

Inlet A: WELDED 3-BOLT FLANGE  
 Outlet A: WELDED 2-BOLT FLANGE  
 Length: 56"



2009-07 8 TOYOTA TUNDRA 5.7L

## 4638

Inlet A: WELDED 7-BOLT FLANGE  
 Outlet A: WELDED 2-BOLT FLANGE  
 Length: 22"



2009-06 4 FORD FUSION 2.3L

# DIRECT FIT

## 4640

Inlet A: WELDED 7-BOLT FLANGE  
 Outlet A: WELDED 2-BOLT FLANGE  
 Length: 15.25"

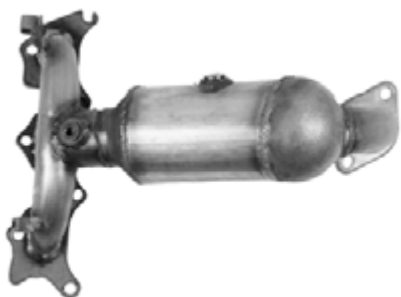

2010-08 6 DODGE AVENGER 2.7L

## 4641

Inlet A: WELDED 7-BOLT FLANGE  
 Outlet A: WELDED 2-BOLT FLANGE  
 Length: 17.50"



2010-08 6 DODGE AVENGER 2.7L

## 4642

Inlet A: WELDED 2-BOLT FLANGE  
 Outlet A: WELDED 2-BOLT FLANGE  
 Length: 85.50"



2009-04 4 TOYOTA PRIUS 1.5L

## 4643

Inlet A: WELDED 2-BOLT FLANGE  
 Outlet A: WELDED 2-BOLT FLANGE  
 Length: 15.50"



2009-07 6 HYUNDAI SANTA FE 2.7L  
 2007 4 KIA RONDO 2.7L

## 4645

Inlet A: WELDED 4-BOLT FLANGE  
 Outlet A: WELDED 3-BOLT FLANGE  
 Length: 17.50"



2009-05 4 AUDI A4 2.0L

## 4646

Inlet A: LOOSE 2-BOLT FLANGE W/ 2.25" FEMALE FLARE  
 Outlet A: 2.50" O.D. PIPE  
 Length: 38"



1994-92 6 BUICK LESABRE 3.8L  
 1994-91 6 BUICK PARK AVENUE 3.8L  
 1994-91 6 OLDSMOBILE 98 3.8L  
 1994-92 6 OLDSMOBILE EIGHTY-EIGHT, DELTA 88 3.8L  
 1994-92 6 PONTIAC BONNEVILLE 3.8L

### 4646G

Inlet A: LOOSE 2-BOLT FLANGE W/ 2.50" FEMALE FLARE  
 Outlet A: 2.63" O.D. PIPE  
 Length: 38"



- 1994-92 6 BUICK LESABRE 3.8L
- 1994-91 6 BUICK PARK AVENUE 3.8L
- 1994-92 6 OLDSMOBILE 98 3.8L
- 1994-92 6 OLDSMOBILE EIGHTY-EIGHT, DELTA 88 3.8L
- 1994-92 6 PONTIAC BONNEVILLE 3.8L

### 4648

Inlet A: WELDED 3-BOLT FLANGE  
 Outlet A: WELDED 3-BOLT FLANGE  
 Length: 20.25"



- 1998-96 4 CHEVROLET CAVALIER 2.2L
- 1998-96 4 PONTIAC SUNFIRE 2.2L

### 4649

Inlet A: LOOSE 2-BOLT FLANGE W/ FEMALE FLARE  
 Outlet A: LOOSE 2-BOLT FLANGE W/ FLAT FLARE  
 Length: 13.25"



- 1997-94 4 FORD ASPIRE 1.3L
- 1991 4 MERCURY CAPRI 1.6L

### 4650

Inlet A: LOOSE 2-BOLT FLANGE W/ SPHERICAL FLARE  
 Inlet B: LOOSE 2-BOLT FLANGE W/ SPHERICAL FLARE  
 Outlet A: WELDED 3-BOLT FLANGE W/ GASKET STUB  
 Length: 20.50"



- 2000-98 6 FORD RANGER 3.0L
- 2000-98 6 MAZDA B-Series PICKUP 3.0L

### 4651

Inlet A: LOOSE 2-BOLT CHRYSLER FLANGE  
 Outlet A: 2.25" O.D. PIPE  
 Length: 33.50"



- 1999-95 4 DODGE NEON 2.0L
- 1999-95 4 PLYMOUTH NEON 2.0L

### 4652

Inlet A: LOOSE 2-BOLT CHRYSLER FLANGE  
 Outlet A: 2.25" O.D. PIPE  
 Length: 42.75"



- 1993-92 6 DODGE CARAVAN 3.3L
- 1993-92 6 PLYMOUTH VOYAGER 3.3L

**DIRECT FIT**

**4653**

Inlet A: LOOSE 2-BOLT FLANGE W/ FLARE  
Inlet B: LOOSE 2-BOLT FLANGE W/ FLARE  
Outlet A: 2" O.D. PIPE  
Outlet B: 2" O.D. PIPE  
Length: 54.50"



2003 8 FORD THUNDERBIRD 3.9L  
2003 8 LINCOLN LS 3.9L

**4654**

Inlet A: WELDED 2-BOLT FLANGE  
Outlet A: 2.00" O.D. PIPE  
Length: 51"



2003 6 AUDI A6 3.0L

**4655**

Inlet A: WELDED 2-BOLT FLANGE  
Outlet A: 2.00" O.D. PIPE  
Length: 52"



2003 6 AUDI A6 3.0L

**4660**

Inlet A: WELDED 3-BOLT FLANGE  
Outlet A: 2.00" O.D. PIPE  
Length: 49"



2001 6 AUDI A4 2.8L  
2005-00 6 VOLKSWAGEN PASSAT 2.8L

**4661**

Inlet A: WELDED 3-BOLT FLANGE  
Outlet A: 2.00" O.D. PIPE  
Length: 63.50"



2001 6 AUDI A4 2.8L

**4662**

Inlet A: WELDED 2-BOLT FLANGE  
Outlet A: WELDED 2-BOLT FLANGE  
Length: 41.50"



2003-01 4 HYUNDAI ELANTRA 2.0L  
2006-03 4 HYUNDAI TIBURON 2.0L

**4663**

Inlet A: LOOSE 2-BOLT FLANGE W/ FEMALE FLARE  
Inlet B: LOOSE 2-BOLT FLANGE W/ FEMALE FLARE  
Outlet A: WELDED 2-BOLT FLANGE  
Length: 40"

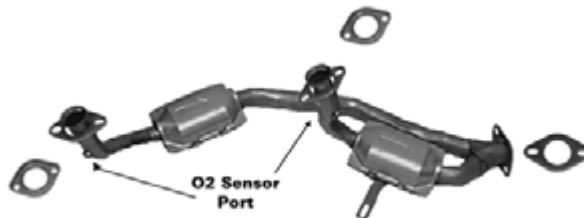

1995-94 6 FORD TAURUS 3.0L  
1995-93 6 MERCURY SABLE 3.0L

**4665**

Inlet A: WELDED 3-BOLT FLANGE  
Outlet A: 2.00" O.D. PIPE  
Length: 51.50"



2005-00 6 VOLKSWAGEN PASSAT 2.8L



## 4666

Inlet A: LOOSE 2-BOLT FLANGE W/ 2.50" FEMALE FLARE  
 Inlet B: LOOSE 2-BOLT FLANGE W/ 2.50" FEMALE FLARE  
 Outlet A: LOOSE 2-BOLT FLANGE W/ 2.50" MALE BALL  
 Outlet B: LOOSE 2-BOLT FLANGE W/ 2.50" MALE BALL  
 Length: 55"

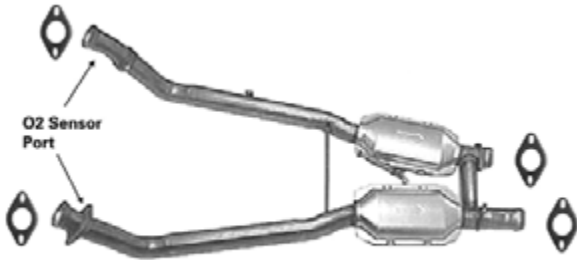

1995-94 8 FORD MUSTANG 5.0L

## 4669

Inlet A: WELDED 2-BOLT FLANGE  
 Outlet A: WELDED 2-BOLT FLANGE  
 Length: 51.25"



1991-89 3 CHEVROLET SPRINT All  
 1995 3 GEO METRO 1.0L  
 1995 3 PONTIAC FIREFLY 1.0L  
 1992-89 4 SUZUKI SWIFT 1.3L

## 4670

Inlet A: WELDED 8-BOLT FLANGE  
 Outlet A: WELDED 2-BOLT FLANGE  
 Length: 30"



2008-03 8 INFiniti FX45 4.5L  
 2010-06 8 INFiniti M45 4.5L

## 4671

Inlet A: WELDED 8-BOLT FLANGE  
 Outlet A: WELDED 2-BOLT FLANGE  
 Length: 29.50"



2008-03 8 INFiniti FX45 4.5L  
 2010-06 8 INFiniti M45 4.5L

## 4672

Inlet A: LOOSE 2-BOLT FLANGE W/ FLARE  
 Outlet A: 2.20" O.D. PIPE  
 Length: 52"



2012-11 6 CHRYSLER 300 3.6L  
 2012-11 6 DODGE CHALLENGER 3.6L  
 2012-11 6 DODGE CHARGER 3.6L

## 4673

Inlet A: LOOSE 2-BOLT FLANGE W/ FLARE  
 Outlet A: 2.20" O.D. PIPE  
 Length: 52"



2012-11 6 CHRYSLER 300 3.6L  
 2012-11 6 DODGE CHALLENGER 3.6L  
 2012-11 6 DODGE CHARGER 3.6L

# DIRECT FIT

## 4674

Inlet A: WELDED 3-BOLT FLANGE  
Outlet A: WELDED 2-BOLT FLANGE  
Length: 42.50"



2001 5 VOLVO S70/V70 2.4L

## 4677

Inlet A: LOOSE 2-BOLT FLANGE W/ FEMALE FLARE  
Inlet B: LOOSE 2-BOLT FLANGE W/ FEMALE FLARE  
Outlet A: WELDED 2-BOLT FLANGE  
Length: 36"



2008 8 JEEP COMMANDER 5.7L

## 4678

Inlet A: LOOSE 3-BOLT FLANGE W/ FEMALE FLARE  
Inlet B: WELDED 3-BOLT FLANGE  
Outlet A: WELDED 2-BOLT FLANGE  
Length: 45.50"



2004 8 BUICK RAINIER 5.3L

## 4681

Inlet A: 2.50" I.D. PIPE  
Outlet A: 2.25" O.D. PIPE  
Length: 21.75"



1995-93 8 JEEP GRAND CHEROKEE/GRAND WAGONEER 5.2L

## 4682

Inlet A: 2.50" I.D. PIPE  
Outlet A: WELDED 3-BOLT FLANGE  
Length: 28"



1995 6 CHEVROLET BLAZER S-Series 4.3L  
1995 6 GMC S-15 JIMMY 4.3L

## 4684

Inlet A: 2.25" I.D. PIPE  
Outlet A: 2.25" O.D. PIPE  
Length: 22"



1995-93 4 JEEP WRANGLER 2.5L

## 4686

Inlet A: WELDED 2-BOLT FLANGE  
Outlet A: WELDED 2-BOLT FLANGE  
Length: 45.75"



2007-05 4 MITSUBISHI LANCER 2.0L

### 4687

Inlet A: WELDED 3-BOLT FLANGE  
 Outlet A: WELDED 3-BOLT FLANGE  
 Length: 18"



2008-04 4 ACURA TSX 2.4L

### 4691

Inlet A: WELDED 3-BOLT FLANGE  
 Outlet A: WELDED 2-BOLT FLANGE  
 Length: 42"



2009-07 8 TOYOTA TUNDRA 4.7L

### 4692

Inlet A: WELDED 2-BOLT FLANGE  
 Outlet A: 2.50" I.D. PIPE  
 Length: 39"



2012-10 6 CHEVROLET EQUINOX 3.0L  
 2012-10 6 GMC TERRAIN 3.0L

### 4693

Inlet A: WELDED 2-BOLT FLANGE  
 Outlet A: WELDED 2-BOLT FLANGE  
 Length: 31.38"



2004-00 6 TOYOTA TACOMA 3.4L

### 4694

Inlet A: WELDED 2-BOLT FLANGE  
 Outlet A: 2.35" O.D. PIPE  
 Length: 20"



2006-04 6 TOYOTA SIENNA 3.3L

### 4695

Inlet A: WELDED 2-BOLT FLANGE  
 Outlet A: WELDED 2-BOLT FLANGE  
 Length: 21.25"



2012-09 6 BUICK ENCLAVE 3.6L  
 2015-09 6 CHEVROLET TRAVERSE 3.6L  
 2012-09 6 GMC ACADIA 3.6L  
 2010-09 6 SATURN OUTLOOK 3.6L

### 4696

Inlet A: WELDED 2-BOLT FLANGE  
 Outlet A: 2.13" O.D. PIPE  
 Length: 39"



2010-08 6 TOYOTA HIGHLANDER 3.3L

# DIRECT FIT

## 4697

Inlet A: WELDED 2-BOLT FLANGE  
 Outlet A: 2.13" O.D. PIPE  
 Length: 24"



2012-09 4 TOYOTA HIGHLANDER 2.7L

## 4698

Inlet A: WELDED 2-BOLT FLANGE  
 Outlet A: WELDED 2-BOLT FLANGE  
 Length: 43.25"



2012-09 4 TOYOTA HIGHLANDER 2.7L

## 4699

Inlet A: 2.13" OD PIPE  
 Outlet A: WELDED 3-BOLT FLANGE  
 Length: 20"



2005-04 4 SUZUKI FORENZA 2.0L  
 2005 4 SUZUKI RENO 2.0L

## 4700

Inlet A: WELDED 2-BOLT FLANGE  
 Outlet A: 2" O.D. PIPE  
 Length: 44.50"



2013-10 4 FORD TRANSIT CONNECT 2.0L

## 4701

Inlet A: LOOSE 2-BOLT FLANGE W/ 2" FLAT FLARE  
 Outlet A: LOOSE 2-BOLT FLANGE W/ 2.25" FLAT FLARE  
 Length: 17"



1992-89 4 FORD PROBE 2.2L  
 1997-96 4 FORD PROBE 2.0L  
 1992-88 4 MAZDA 626 2.2L  
 1997-96 4 MAZDA 626 2.0L  
 1992-88 4 MAZDA MX6 2.2L  
 1997-96 4 MAZDA MX6 2.0L

## 4702

Inlet A: LOOSE 2-BOLT FLANGE W/ FEMALE FLARE  
 Inlet B: LOOSE 2-BOLT FLANGE W/ FEMALE FLARE  
 Outlet A: WELDED 2-BOLT FLANGE  
 Length: 44.50"

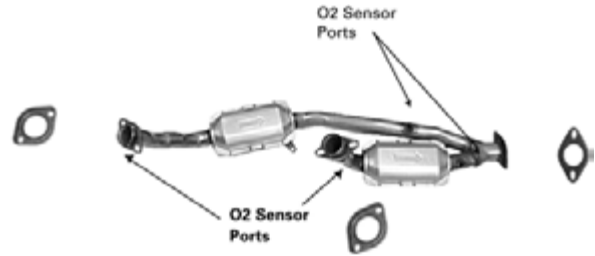

1998-97 6 FORD WINDSTAR 3.8L

## 4703

Inlet A: LOOSE 2-BOLT FLANGE W/ FLARE  
 Inlet B: LOOSE 2-BOLT FLANGE W/ FLARE  
 Outlet A: WELDED 2-BOLT FLANGE  
 Length: 44.75"



2000-98 6 FORD WINDSTAR 3.8L

### 4704

Inlet A: LOOSE 2-BOLT FLANGE W/ 2.25" FEMALE FLARE  
 Inlet B: LOOSE 2-BOLT FLANGE W/ 2.25" FEMALE FLARE  
 Outlet A: LOOSE 2-BOLT FLANGE W/ MALE BALL  
 Outlet B: 2" O.D. PIPE  
 Length: 62.75"

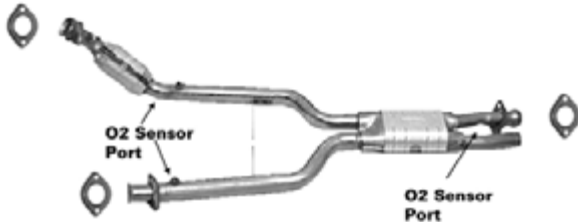

1998-93 8 LINCOLN MARK Series 4.6L

### 4705

Inlet A: WELDED 3-BOLT FLANGE  
 Outlet A: WELDED 2-BOLT FLANGE  
 Length: 36.50"



2007-05 4 CHEVROLET COBALT 2.0L  
 2007-05 4 SATURN ION 2.0L

### 4706

Inlet A: WELDED 8-BOLT FLANGE  
 Outlet A: WELDED 2-BOLT FLANGE  
 Length: 23"



2007-06 6 BMW 525 3.0L  
 2007-06 6 BMW 530 3.0L

### 4707

Inlet A: WELDED 8-BOLT FLANGE  
 Outlet A: WELDED 2-BOLT FLANGE  
 Length: 32"



2007-06 6 BMW 525 3.0L  
 2007-06 6 BMW 530 3.0L

### 4708

Inlet A: 1.75" PIPE  
 Outlet A: WELDED 2-BOLT FLANGE  
 Length: 43"



2007-06 6 BMW 525 3.0L  
 2007-06 6 BMW 530 3.0L

### 4709

Inlet A: 1.75" PIPE  
 Outlet A: WELDED 2-BOLT FLANGE  
 Length: 40.50"



2007-06 6 BMW 525 3.0L  
 2007-06 6 BMW 530 3.0L

### 4710

Inlet A: WELDED 2-BOLT FLANGE  
 Outlet A: WELDED 2-BOLT FLANGE  
 Length: 13"



2012-10 4 HYUNDAI SANTA FE 2.4L  
 2013-11 4 KIA SORENTO 2.4L

# DIRECT FIT

## 4711

Inlet A: WELDED 2-BOLT FLANGE  
 Outlet A: WELDED 2-BOLT FLANGE  
 Length: 18"



- 2001-97 6 MITSUBISHI MONTERO SPORT 3.0L
- 2001-99 6 MITSUBISHI MONTERO SPORT 3.5L

## 4712

Inlet A: WELDED 2-BOLT FLANGE  
 Outlet A: 2.25" O.D. PIPE  
 Length: 19.25"



- 2009-08 6 FORD TAURUS X 3.5L
- 2009-08 6 FORD TAURUS 3.5L
- 2009-08 6 MERCURY SABLE 3.5L

## 4713

Inlet A: LOOSE 2-BOLT FLANGE W/ FEMALE FLARE  
 Outlet A: LOOSE 2-BOLT FLANGE W/ FLAT FLARE  
 Length: 15.25"



- 2002-97 4 MITSUBISHI MIRAGE 1.8L

## 4714

Inlet A: WELDED 2-BOLT FLANGE  
 Outlet A: 2.50" O.D. PIPE  
 Length: 16"



- 2012-08 4 CHEVROLET MALIBU 2.4L
- 2010-08 4 PONTIAC G6 2.4L
- 2009-08 4 SATURN AURA 2.4L

## 4716

Inlet A: WELDED 2-BOLT FLANGE  
 Outlet A: WELDED 3-BOLT FLANGE  
 Length: 16.63"



- 1995-93 4 HONDA CIVIC DEL SOL 1.5L
- 1995-93 4 HONDA CIVIC DEL SOL 1.6L
- 1995-92 4 HONDA CIVIC 1.5L
- 1995-93 4 HONDA CIVIC 1.6L

## 4719

Inlet A: LOOSE 2-BOLT FLANGE W/ SPECIAL FLARE  
 Outlet A: WELDED 3-BOLT FLANGE  
 Length: 38.25"



- 1995-93 4 BUICK SKYLARK 2.3L
- 1995-93 4 OLDSMOBILE ACHIEVA 2.3L
- 1995-93 4 PONTIAC GRAND AM 2.3L

## 4721

Inlet A: WELDED 5-BOLT FLANGE  
 Outlet A: WELDED 2-BOLT FLANGE  
 Length: 24.38"



2007-04 4 SUBARU IMPREZA 2.5L

## 4724

Inlet A: WELDED 2-BOLT FLANGE  
 Outlet A: WELDED 2-BOLT FLANGE  
 Length: 13"



2008-05 4 HYUNDAI TUCSON 2.0L  
 2010-05 4 KIA SPORTAGE 2.0L

## 4722

Inlet A: WELDED 3-BOLT FLANGE W/ STUDS  
 Outlet A: WELDED 2-BOLT FLANGE  
 Length: 21.25"



1996-95 6 FORD CONTOUR 2.5L  
 1996-95 6 MERCURY MYSTIQUE 2.5L

## 4723

Inlet A: WELDED 2-BOLT FLANGE  
 Outlet A: 2.36" I.D. PIPE  
 Length: 22"



2012-06 6 TOYOTA RAV4 3.5L

## 4725

Inlet A: WELDED 2-BOLT FLANGE  
 Outlet A: WELDED 2-BOLT FLANGE  
 Length: 18"



2008-05 6 HYUNDAI TUCSON 2.7L  
 2010-05 6 KIA SPORTAGE 2.7L

## 4726

Inlet A: WELDED 2-BOLT FLANGE  
 Outlet A: WELDED 2-BOLT FLANGE  
 Length: 16"



2008-07 6 HYUNDAI ENTOURAGE 3.8L  
 2010-06 6 KIA SEDONA 3.8L

# DIRECT FIT

## 4727

Inlet A: WELDED 2-BOLT FLANGE  
 Outlet A: WELDED 2-BOLT FLANGE  
 Length: 17.50"



- 2010 4 HYUNDAI SONATA 2.4L
- 2012-10 4 KIA FORTE KOUP 2.4L
- 2012-10 4 KIA FORTE 2.4L
- 2010-09 4 KIA OPTIMA 2.4L
- 2010-09 4 KIA RONDO 2.4L

## 4730

Inlet A: WELDED 2-BOLT FLANGE  
 Outlet A: WELDED 2-BOLT FLANGE  
 Length: 10.50"

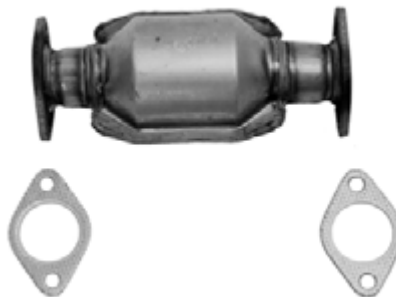

- 2011-10 4 HYUNDAI ACCENT 1.6L

## 4728

Inlet A: WELDED 3-BOLT FLANGE  
 Inlet B: WELDED 2-BOLT FLANGE  
 Outlet A: WELDED 2-BOLT FLANGE  
 Length: 28.25"



- 2006-05 6 PONTIAC G6 3.5L

## 4732

Inlet A: WELDED 2-BOLT FLANGE W/ GASKET STUB  
 Inlet B: WELDED 2-BOLT FLANGE  
 Outlet A: WELDED 2-BOLT FLANGE W/ GASKET STUB  
 Length: 32.25"



- 2009-05 8 LEXUS GX470 4.7L
- 2009-05 8 TOYOTA 4 RUNNER 4.7L

## 4729

Inlet A: WELDED 2-BOLT FLANGE  
 Outlet A: WELDED 2-BOLT FLANGE  
 Length: 46.25"



- 2005-04 4 HYUNDAI ELANTRA 2.0L

## 4733

Inlet A: 2.25" O.D. PIPE  
 Outlet A: 2.25" O.D. PIPE  
 Length: 57"



- 1989-87 6 DODGE DAKOTA 3.9L



### 4738

Inlet A: WELDED 16-BOLT FLANGE  
 Outlet A: WELDED 2-BOLT FLANGE  
 Length: 28.25"



2006-04	V8	INFINITI QX56 5.6L
2006-05	8	NISSAN ARMADA 5.6L
2004	8	NISSAN PATHFINDER 5.6L
2006-04	8	NISSAN TITAN 5.6L

### 4739

Inlet A: WELDED 16-BOLT FLANGE  
 Outlet A: WELDED 2-BOLT FLANGE  
 Length: 29.25"



2006-04	V8	INFINITI QX56 5.6L
2006-05	8	NISSAN ARMADA 5.6L
2004	8	NISSAN PATHFINDER 5.6L
2006-04	8	NISSAN TITAN 5.6L

### 4742

Inlet A: LOOSE 2-BOLT FLANGE W/ FEMALE FLARE  
 Outlet A: 2.25" O.D. PIPE  
 Length: 22"



1995-94	8	CADILLAC DEVILLE 4.9L
1993	8	CADILLAC ELDORADO 4.9L
1993	8	CADILLAC SEVILLE 4.9L

### 4742G

Inlet A: LOOSE 2-BOLT FLANGE W/ FEMALE FLARE  
 Outlet A: 2.38" O.D. PIPE  
 Length: 22"



1995-94	8	CADILLAC DEVILLE 4.9L
1993	8	CADILLAC ELDORADO 4.9L
1993	8	CADILLAC SEVILLE 4.9L

### 4743

Inlet A: WELDED 2-BOLT FLANGE  
 Outlet A: 2.38" O.D. PIPE  
 Length: 37.50"



2015-09	6	TOYOTA VENZA 3.5L
---------	---	-------------------

### 4744

Inlet A: LOOSE 2-BOLT FLANGE  
 Outlet A: WELDED 2-BOLT FLANGE  
 Length: 46"



2006-05	8	PONTIAC GTO 6.0L
---------	---	------------------

### 4745

Inlet A: LOOSE 2-BOLT FLANGE  
 Outlet A: WELDED 2-BOLT FLANGE  
 Length: 46"



2006-05	8	PONTIAC GTO 6.0L
---------	---	------------------

# DIRECT FIT

## 4746

Inlet A: WELDED 2-BOLT FLANGE  
Outlet A: 2.36" O.D. PIPE  
Length: 21"



2010-08 6 PONTIAC G6 3.5L

## 4747

Inlet A: WELDED 2-BOLT FLANGE  
Outlet A: 2.13" O.D. PIPE  
Length: 17.50"



2009-07 4 MAZDA 3 2.0L  
2009-07 4 MAZDA 3 2.3L

## 4748

Inlet A: WELDED 2-BOLT FLANGE  
Outlet A: 2.35" O.D. PIPE  
Length: 16"



2006-04 6 TOYOTA SIENNA 3.3L

## 4757

Inlet A: WELDED 2-BOLT FLANGE  
Inlet B: WELDED 2-BOLT FLANGE  
Outlet A: WELDED 2-BOLT FLANGE W/ GASKET STUB  
Length: 50"



2007-05 6 TOYOTA AVALON 3.5L

## 4758

Inlet A: WELDED 2-BOLT FLANGE  
Outlet A: WELDED 2-BOLT FLANGE  
Length: 26"



2006-04 V8 INFiniti QX56 5.6L  
2010-07 8 INFiniti QX56 5.6L  
2015-05 8 NISSAN ARMADA 5.6L  
2015-04 8 NISSAN TITAN 5.6L

## 4759

Inlet A: WELDED 2-BOLT FLANGE  
Outlet A: WELDED 2-BOLT FLANGE  
Length: 28.50"



2006-04 V8 INFiniti QX56 5.6L  
2006-05 8 NISSAN ARMADA 5.6L  
2006-04 8 NISSAN TITAN 5.6L

## 4760

Inlet A: WELDED 2-BOLT FLANGE  
 Outlet A: WELDED 2-BOLT FLANGE  
 Length: 59"



2005-02 6 BUICK RENDEZVOUS 3.4L  
 2007-06 6 BUICK RENDEZVOUS 3.5L  
 2005-01 6 PONTIAC AZTEK 3.4L

## 4762

Inlet A: WELDED 2-BOLT FLANGE W/ SPHERICAL FLARE  
 Outlet A: 1.70" I.D. PIPE  
 Length: 16.13"



2003-01 4 TOYOTA PRIUS 1.5L

## 4765

Inlet A: LOOSE 2-BOLT FLANGE W/ CHRYSLER FLARE  
 Outlet A: 2.25" O.D. PIPE  
 Length: 41.88"



1991-89 6 DODGE CARAVAN 3.0L  
 1991-89 6 PLYMOUTH VOYAGER 3.0L

## 4766

Inlet A: WELDED 3-BOLT FLANGE  
 Outlet A: WELDED 2-BOLT FLANGE  
 Length: 22.50"



2004-03 6 CADILLAC CTS 3.2L

## 4767

Inlet A: WELDED 3-BOLT FLANGE  
 Outlet A: WELDED 2-BOLT FLANGE  
 Length: 20.25"



2004-03 6 CADILLAC CTS 3.2L

## 4768

Inlet A: WELDED 3-BOLT FLANGE  
 Outlet A: WELDED 2-BOLT FLANGE  
 Length: 35.25"



2000-96 4 TOYOTA 4 RUNNER 2.7L

## 4769

Inlet A: WELDED 2-BOLT FLANGE  
 Outlet A: WELDED 2-BOLT FLANGE  
 Length: 25"



2006-04 4 SUBARU IMPREZA 2.5L

**DIRECT FIT**

**4770**

Inlet A: WELDED 2-BOLT FLANGE  
Outlet A: WELDED 2-BOLT FLANGE  
Length: 13"



2005 8 INFINITI FX45 4.5L

**4771**

Inlet A: WELDED 2-BOLT FLANGE  
Outlet A: WELDED 2-BOLT FLANGE  
Length: 13"



2005 8 INFINITI FX45 4.5L

**4772**

Inlet A: WELDED 2-BOLT FLANGE  
Outlet A: WELDED 2-BOLT FLANGE  
Length: 13.50"



2004-98 4 NISSAN FRONTIER 2.4L  
1997-96 4 NISSAN PICKUP 2.4L

**4773**

Inlet A: LOOSE 2-BOLT FLANGE W/ FEMALE FLARE  
Inlet B: LOOSE 2-BOLT FLANGE W/ FEMALE FLARE  
Outlet A: 2.50" O.D. PIPE  
Length: 35.75"



2004-02 8 JEEP GRAND CHEROKEE/GRAND WAGONEER 4.7L

**4774**

Inlet A: WELDED 3- BOLT FLANGE  
Outlet A: WELDED 3-BOLT FLANGE  
Length: 10.50"



2012-09 4 ACURA TSX 2.4L  
2012-08 4 HONDA ACCORD 2.4L

**4775**

Inlet A: LOOSE 2-BOLT FLANGE W/ CHRYSLER FLARE  
Outlet A: 1-7/8" O.D. PIPE  
Length: 40.50"



1988-86 4 CHRYSLER LEBARON 2.5L  
1987-86 4 CHRYSLER NEW YORKER 2.5L  
1988-87 4 DODGE ARIES, 400, 600 2.2L  
1989-86 4 DODGE ARIES, 400, 600 2.5L  
1988-86 4 DODGE LANCER 2.5L  
1988-86 4 PLYMOUTH CARAVELLE 2.5L  
1988 4 PLYMOUTH CARAVELLE 2.2L  
1988-87 4 PLYMOUTH RELIANT 2.2L  
1989-86 4 PLYMOUTH RELIANT 2.5L

### 4776

Inlet A: WELDED 2-BOLT FLANGE  
 Outlet A: WELDED 3-BOLT FLANGE  
 Length: 31.75"



2004-02 4 ACURA RSX 2.0L

### 4777

Inlet A: LOOSE 4-BOLT FLANGE W/ 45 DEGREE FLARE  
 Outlet A: LOOSE 4-BOLT FLANGE W/ 2.25" FLAT FLARE  
 Length: 17.50"



1993-85 4 SAAB 900 2.0L  
 1993-91 4 SAAB 900 2.1L

### 4779

Inlet A: WELDED 2-BOLT FLANGE W/ FEMALE FLARE  
 Outlet A: WELDED 4-BOLT FLANGE  
 Length: 40.75"



1995-91 6 CHEVROLET LUMINA 3.4L  
 1995 6 CHEVROLET MONTE CARLO 3.4L  
 1995-91 6 OLDSMOBILE CUTLASS 3.4L  
 1995-91 6 PONTIAC GRAND PRIX 3.4L

### 4781

Inlet A: LOOSE 2-BOLT FLANGE W/ SPECIAL FLARE  
 Outlet A: 2.25" O.D. PIPE  
 Length: 57.50"



1996 6 CHEVROLET LUMINA APV 3.4L  
 1996 6 OLDSMOBILE SILHOUETTE 3.4L  
 1996 6 PONTIAC TRANS SPORT 3.4L

### 4789

Inlet A: WELDED 2-BOLT FLANGE  
 Outlet A: WELDED 4-BOLT FLANGE  
 Length: 67.25"



1996-93 4 BUICK CENTURY 2.2L  
 1996-93 4 OLDSMOBILE CIERA 2.2L

### 4790

Inlet A: LOOSE 2-BOLT FLANGE W/ FEMALE FLARE  
 Outlet A: WELDED 2-BOLT FLANGE W/ GASKET STUB  
 Length: 36.13"



1995-94 4 GEO TRACKER 1.6L  
 1995-93 4 SUZUKI SIDEKICK 1.6L

### 4792

Inlet A: WELDED 3-BOLT FLANGE  
 Outlet A: WELDED 3-BOLT FLANGE  
 Length: 27.75"

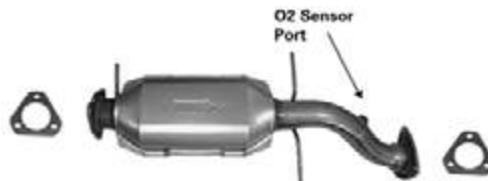

1999-96 6 CHEVROLET BLAZER S-Series 4.3L  
 1999-96 6 GMC S-15 JIMMY 4.3L  
 1999-96 6 OLDSMOBILE BRAVADA 4.3L

### 4793

Inlet A: LOOSE 2-BOLT FLANGE W/ SPHERICAL FLARE  
 Outlet A: WELDED 3-BOLT FLANGE  
 Length: 39.50"



1995-94 6 BUICK SKYLARK 3.1L  
 1995-94 6 CHEVROLET BERETTA 3.1L  
 1995-94 6 CHEVROLET CORSICA 3.1L  
 1995-94 6 OLDSMOBILE ACHIEVA 3.1L  
 1995-94 6 PONTIAC GRAND AM 3.1L

# DIRECT FIT

## 4800

Inlet A: WELDED 8-BOLT FLANGE  
 Outlet A: WELDED 2-BOLT FLANGE  
 Length: 20.75"



2000	6	BMW 323CI 2.5L
2000-99	6	BMW 323I 2.5L
2000-99	6	BMW 328 2.8L
2000-99	6	BMW Z3 2.5L
2000-99	6	BMW Z3 2.8L

## 4801

Inlet A: WELDED 8-BOLT FLANGE  
 Outlet A: WELDED 2-BOLT FLANGE  
 Length: 29.75"



2000	6	BMW 323CI 2.5L
2000-99	6	BMW 323I 2.5L
2000-99	6	BMW 328 2.8L
2000-99	6	BMW 528 2.8L
2000-99	6	BMW Z3 2.5L
2000-99	6	BMW Z3 2.8L

## 4802

Inlet A: WELDED 8-BOLT FLANGE  
 Outlet A: WELDED 2-BOLT FLANGE  
 Length: 22.25"



2000-99	6	BMW 528 2.8L
---------	---	--------------

## 4803

Inlet A: LOOSE 2-BOLT FLANGE W/ SPHERICAL FLARE  
 Outlet A: WELDED 2-BOLT FLANGE  
 Length: 37.50"



2011-03	8	FORD CROWN VICTORIA (Inc. Police, Taxi, Station Wagon) 4.6L
2011-03	8	LINCOLN TOWN CAR 4.6L
2011-03	8	MERCURY GRAND MARQUIS FULL SIZE 4.6L
2004-03	8	MERCURY MARAUDER 4.6L

## 4804

Inlet A: WELDED 3-BOLT FLANGE  
 Outlet A: WELDED 3-BOLT FLANGE  
 Length: 6.75"



2008-04	4	SUZUKI FORENZA 2.0L
2008-05	4	SUZUKI RENO 2.0L

## 4805

Inlet A: WELDED 2-BOLT FLANGE  
 Outlet A: 2.13" O.D. PIPE  
 Length: 36"



2008-03	4	PONTIAC VIBE 1.8L
2008-03	4	TOYOTA COROLLA 1.8L
2008-03	4	TOYOTA MATRIX 1.8L

### 4806

Inlet A: WELDED 2-BOLT FLANGE  
 Outlet A: 1.88" O.D. PIPE W/ SPHERICAL RING  
 Length: 84"



2006-04 4 SCION XB 1.5L

### 4807

Inlet A: WELDED 2-BOLT FLANGE  
 Outlet A: WELDED 2-BOLT FLANGE  
 Length: 16.50"



2007-06 6 HYUNDAI SONATA 3.3L

### 4808

Inlet A: WELDED 2-BOLT FLANGE  
 Outlet A: WELDED 2-BOLT FLANGE  
 Length: 14.75"



2005-04 4 HYUNDAI ELANTRA 2.0L  
 2007-04 4 KIA SPECTRA 2.0L  
 2007-06 4 KIA SPECTRA5 2.0L

### 4810

Inlet A: LOOSE 2-BOLT FLANGE W/ FEMALE FLARE  
 Inlet B: LOOSE 2-BOLT FLANGE W/ FEMALE FLARE  
 Outlet A: WELDED 2-BOLT FLANGE  
 Length: 42.50"

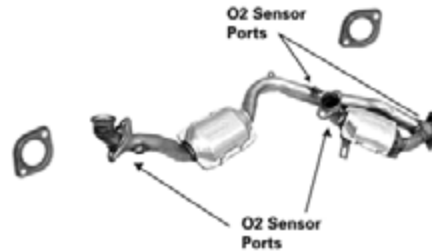

2002-95 8 LINCOLN CONTINENTAL 4.6L

### 4811

Inlet A: WELDED 2-BOLT FLANGE  
 Outlet A: 2.25" O.D. PIPE  
 Length: 14.63"



2002-95 8 LINCOLN CONTINENTAL 4.6L

### 4812

Inlet A: WELDED 3-BOLT FLANGE W/ GASKET STUB  
 Outlet A: WELDED 2-BOLT FLANGE  
 Length: 45.25"



1996-94 4 TOYOTA CAMRY, (Inc. 1998 & Older SOLARA) 2.2L

### 4813

Inlet A: WELDED 2-BOLT FLANGE W/ STUDS  
 Outlet A: WELDED 2-BOLT FLANGE  
 Length: 13"



1999-98 4 KIA SEPHIA 1.8L

# DIRECT FIT

## 4815

Inlet A: 2.50" O.D. PIPE  
 Outlet A: 2.75" O.D. PIPE  
 Length: 24.50"



- 1991 8 CADILLAC DEVILLE 4.9L
- 1991 8 CADILLAC FLEETWOOD 4.9L

## 4816

Inlet A: WELDED 3-BOLT FLANGE  
 Outlet A: WELDED 2-BOLT FLANGE W/ GASKET STUB  
 Length: 34.50"



- 1997-96 6 FORD RANGER 3.0L
- 1997-96 6 FORD RANGER 4.0L
- 1997-96 6 MAZDA B-Series PICKUP 3.0L
- 1997-96 6 MAZDA B-Series PICKUP 4.0L

## 4817

Inlet A: WELDED 3-BOLT FLANGE  
 Outlet A: WELDED 3-BOLT FLANGE  
 Length: 24"



- 1996 4 CHEVROLET BERETTA 2.2L
- 1996 4 CHEVROLET CORSICA 2.2L

## 4819

Inlet A: WELDED 3-BOLT FLANGE  
 Outlet A: WELDED 3-BOLT FLANGE W/ GASKET STUB  
 Length: 27.50"



- 2003-96 4 CHEVROLET S-Series (2WD), T-Series (4WD) PICKUP 2.2L

## 4819 (cont.)

- 2003-96 4 GMC S-Series (2WD), T-Series (4WD) PICKUP (SONOMA) 2.2L
- 2000-96 4 ISUZU PICKUP 2.2L

## 4820

Inlet A: WELDED 2-BOLT FLANGE W/ GASKET STUB  
 Outlet A: WELDED 2-BOLT FLANGE W/ GASKET STUB  
 Length: 36"



- 1998-97 4 MAZDA PROTÉGÉ 1.5L

## 4821

Inlet A: WELDED 3-BOLT FLANGE  
 Outlet A: WELDED 3-BOLT FLANGE  
 Length: 17.25"



- 1997-95 6 HONDA ACCORD 2.7L

## 4823

Inlet A: WELDED 4-BOLT FLANGE  
 Outlet A: WELDED 3-BOLT FLANGE W/ GASKET STUB  
 Length: 38.25"



- 1998-96 4 BUICK SKYLARK 2.4L
- 1998-96 4 OLDSMOBILE ACHIEVA 2.4L
- 1998-96 4 PONTIAC GRAND AM 2.4L

## 4828

Inlet A: WELDED 2-BOLT FLANGE  
 Outlet A: WELDED 3-BOLT FLANGE  
 Length: 17.50"



- 1995-93 4 HONDA CIVIC DEL SOL 1.5L



### 4828 (cont.)

1995-93	4	HONDA CIVIC DEL SOL 1.6L
1989-88	4	HONDA CIVIC AII
1995-88	4	HONDA CIVIC 1.5L
1995-89	4	HONDA CIVIC 1.6L
1991-88	4	HONDA CRX 1.5L
1991-88	4	HONDA CRX 1.6L
1995	4	HONDA ODYSSEY 2.2L

### 4830

Inlet A: WELDED 3-BOLT FLANGE  
 Outlet A: WELDED 3-BOLT FLANGE  
 Length: 14"



1993-90	4	HONDA ACCORD 2.2L
1987-85	4	HONDA PRELUDE 2.0L
1995-92	4	HONDA PRELUDE 2.2L
1995-92	4	HONDA PRELUDE 2.3L

### 4831

Inlet A: WELDED 2-BOLT FLANGE  
 Outlet A: WELDED 3-BOLT FLANGE  
 Length: 40"



1998	6	OLDSMOBILE ACHIEVA 3.1L
------	---	-------------------------

### 4832

Inlet A: WELDED 3-BOLT FLANGE  
 Inlet B: WELDED 3-BOLT FLANGE  
 Outlet A: WELDED 2-BOLT FLANGE W/ GASKET STUB  
 Length: 51.50"



1994-90	4	SUBARU LEGACY 2.2L
---------	---	--------------------

### 4835

Inlet A: WELDED 2-BOLT FLANGE W/ GASKET STUB  
 Inlet B: WELDED 2-BOLT FLANGE W/ GASKET STUB  
 Outlet A: WELDED 2-BOLT FLANGE W/ GASKET STUB  
 Length: 49"



1999-97	6	LEXUS ES300 3.0L
1999-97	6	TOYOTA AVALON 3.0L
2000-97	6	TOYOTA CAMRY, (Inc. 1998 & Older SOLARA) 3.0L
2003-99	6	TOYOTA SOLARA 3.0L

### 4838

Inlet A: LOOSE 2-BOLT FLANGE W/ SPECIAL FLARE  
 Outlet A: WELDED 4-BOLT FLANGE  
 Length: 47"



1996-95	6	BUICK REGAL 3.1L
1996-95	6	CHEVROLET LUMINA 3.1L
1996-95	6	CHEVROLET MONTE CARLO 3.1L
1996-95	6	OLDSMOBILE CUTLASS 3.1L
1996-95	6	PONTIAC GRAND PRIX 3.1L

### 4839

Inlet A: WELDED 2-BOLT FLANGE  
 Outlet A: WELDED 3-BOLT FLANGE  
 Length: 16.63"



2000-99	4	HONDA CIVIC 1.6L
---------	---	------------------

### 4840

Inlet A: WELDED 4-BOLT FLANGE  
 Outlet A: 2.50" I.D. PIPE  
 Length: 26.25"



1999-96	8	CADILLAC DEVILLE 4.6L
1999-96	8	CADILLAC ELDORADO 4.6L
1997-96	8	CADILLAC SEVILLE 4.6L

# DIRECT FIT

## 4841

Inlet A: WELDED 2-BOLT FLANGE  
 Outlet A: WELDED 2-BOLT FLANGE  
 Length: 12.50"



- 1999-96 6 INFINITI I30 3.0L
- 1996-95 4 NISSAN 200SX 1.6L
- 1997-95 4 NISSAN 200SX 2.0L
- 1997-93 4 NISSAN ALTIMA 2.4L
- 2000-95 6 NISSAN MAXIMA 3.0L
- 1996-95 4 NISSAN SENTRA 1.6L

## 4842

Inlet A: LOOSE 2-BOLT FLANGE W/ FEMALE FLARE  
 Outlet A: WELDED 2-BOLT FLANGE W/ GASKET STUB  
 Length: 55.50"



- 1994-90 4 SUBARU LEGACY 2.2L

## 4846

Inlet A: WELDED 2-BOLT FLANGE  
 Outlet A: WELDED 2-BOLT FLANGE  
 Length: 13"



- 2001-99 4 KIA SEPHIA 1.8L
- 2004-00 4 KIA SPECTRA 1.8L
- 2006-05 4 KIA SPECTRA 2.0L

## 4847

Inlet A: WELDED 3-BOLT FLANGE  
 Outlet A: WELDED 2-BOLT FLANGE  
 Length: 27.50"



- 2000-98 4 KIA SPORTAGE 2.0L

## 4848

Inlet A: WELDED 2-BOLT FLANGE  
 Outlet A: 2.13" O.D. PIPE  
 Length: 24.75"



- 2012-04 4 MITSUBISHI GALANT 2.4L

## 4849

Inlet A: WELDED 2-BOLT FLANGE  
 Outlet A: WELDED 3-BOLT FLANGE W/ GASKET STUB  
 Length: 40.13"



- 1998-97 6 BUICK SKYLARK 3.1L
- 1998-97 6 OLDSMOBILE ACHIEVA 3.1L
- 1998-97 6 PONTIAC GRAND AM 3.1L

## 4850

Inlet A: WELDED 2-BOLT FLANGE  
 Outlet A: WELDED 2-BOLT FLANGE  
 Length: 41.50"



- 2005-97 6 BUICK CENTURY 3.1L
- 2005-00 6 CHEVROLET IMPALA FWD 3.4L
- 2005-00 6 CHEVROLET MONTE CARLO 3.4L
- 2003-97 6 PONTIAC GRAND PRIX 3.1L

## 4851

Inlet A: 45 DEGREE FLARE  
 Outlet A: 2.25" O.D. PIPE  
 Length: 44"

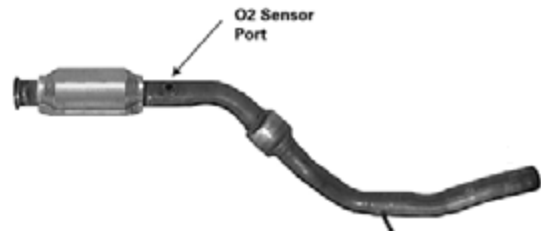

- 2004-99 6 CHRYSLER 300M 3.5L
- 2001-98 6 CHRYSLER CONCORDE 3.2L

### 4851 (cont.)

2004-02	6	CHRYSLER CONCORDE 3.5L
2004-98	6	CHRYSLER CONCORDE 2.7L
2001-99	6	CHRYSLER LHS 3.5L
2001-98	6	DODGE INTREPID 3.2L
2004-00	6	DODGE INTREPID 3.5L
2004-98	6	DODGE INTREPID 2.7L

### 4852

Inlet A: 45 DEGREE FLARE  
 Outlet A: 2.25" O.D. PIPE  
 Length: 26"



2001-98	6	CHRYSLER CONCORDE 2.7L
2001-98	6	DODGE INTREPID 2.7L

### 4853

Inlet A: WELDED 3-BOLT FLANGE W/ DUAL GASKET STUB  
 Outlet A: WELDED 2-BOLT FLANGE  
 Length: 41.75"

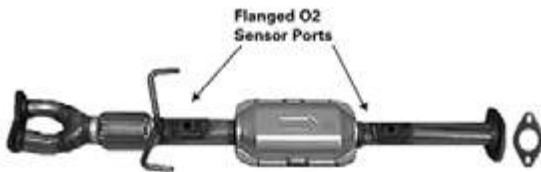

1997-94	4	TOYOTA PREVIA VAN 2.4L
---------	---	------------------------

### 4854

Inlet A: WELDED 3-BOLT FLANGE  
 Outlet A: LOOSE 3-BOLT FLANGE W/ FLAT FLARE  
 Length: 42"



1998-96	4	SATURN SC2 1.9L
1998-96	4	SATURN SL2 1.9L
1998-96	4	SATURN SW2 1.9L

### 4856

Inlet A: LOOSE 2-BOLT FLANGE W/ FEMALE FLARE  
 Outlet A: LOOSE 2-BOLT FLANGE W/ GASKET STUB  
 Length: 47.50"



1997-95	4	FORD RANGER 2.3L
1997-95	4	MAZDA B-Series PICKUP 2.3L

### 4857

Inlet A: LOOSE 2-BOLT FLANGE W/ FEMALE FLARE  
 Inlet B: LOOSE 2-BOLT FLANGE W/ FEMALE FLARE  
 Outlet A: WELDED 2-BOLT FLANGE  
 Length: 46"



1998-97	6	FORD WINDSTAR 3.0L
---------	---	--------------------

### 4858

Inlet A: LOOSE 2-BOLT FLANGE W/ FEMALE FLARE  
 Inlet B: LOOSE 2-BOLT FLANGE W/ FEMALE FLARE  
 Outlet A: 2.25" O.D. PIPE  
 Length: 51.50"

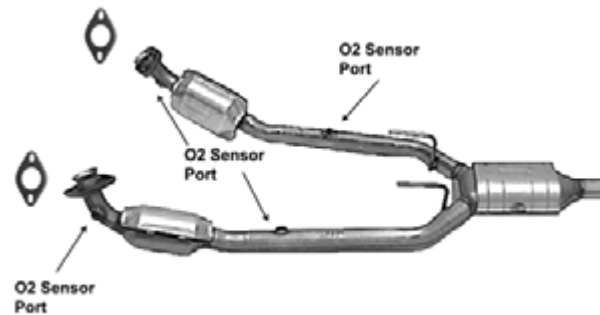

1997-96	6	FORD THUNDERBIRD 3.8L
1997-96	6	MERCURY COUGAR 3.8L

# DIRECT FIT

## 4859

Inlet A: WELDED 4-BOLT FLANGE  
 Outlet A: 2.25" O.D. PIPE  
 Length: 39"



- 2000-95 4 CHRYSLER CIRRUS 2.4L
- 2000-95 6 CHRYSLER CIRRUS 2.5L
- 1998-96 4 CHRYSLER SEBRING 2.4L
- 2000-96 6 CHRYSLER SEBRING 2.5L
- 2000-95 4 DODGE STRATUS 2.4L
- 2000-95 6 DODGE STRATUS 2.5L
- 2000-98 4 PLYMOUTH BREEZE 2.4L

## 4860

Inlet A: WELDED 2-BOLT FLANGE  
 Outlet A: WELDED 2-BOLT FLANGE  
 Length: 29.50"



- 2000-95 6 FORD CONTOUR 2.5L
- 2000-99 6 MERCURY COUGAR 2.5L
- 2000-95 6 MERCURY MYSTIQUE 2.5L

## 4862

Inlet A: LOOSE 2-BOLT FLANGE W/ FEMALE FLARE  
 Outlet A: WELDED 2-BOLT FLANGE  
 Length: 39.50"



- 1996 6 BUICK SKYLARK 3.1L
- 1996 6 CHEVROLET BERETTA 3.1L
- 1996 6 CHEVROLET CORSICA 3.1L
- 1996 6 OLDSMOBILE ACHIEVA 3.1L
- 1996 6 PONTIAC GRAND AM 3.1L

## 4863

Inlet A: WELDED 2-BOLT FLANGE  
 Outlet A: WELDED 3-BOLT FLANGE  
 Length: 40.75"



- 2003-98 6 CHEVROLET MALIBU 3.1L
- 2004-99 6 OLDSMOBILE ALERO 3.4L
- 1999-98 6 OLDSMOBILE CUTLASS 3.1L
- 2005-99 6 PONTIAC GRAND AM 3.4L

## 4864

Inlet A: WELDED 2-BOLT FLANGE W/ GASKET STUB  
 Outlet A: WELDED 3-BOLT FLANGE W/ GASKET STUB  
 Length: 58.88"



- 2002-99 4 CHEVROLET CAVALIER 2.2L
- 2002-99 4 PONTIAC SUNFIRE 2.2L

## 4865

Inlet A: WELDED 4-BOLT FLANGE W/ GASKET STUB  
 Outlet A: WELDED 2-BOLT FLANGE  
 Length: 17.25"



- 2002-97 4 FORD ESCORT 2.0L
- 1999-97 4 MERCURY TRACER 2.0L

### 4867

Inlet A: WELDED 2-BOLT FLANGE  
 Outlet A: WELDED 2-BOLT FLANGE  
 Length: 12.38"



1994 6 NISSAN MAXIMA 3.0L  
 1994-91 4 NISSAN SENTRA 2.0L  
 1995-91 4 NISSAN SENTRA 1.6L

### 4868

Inlet A: LOOSE 2-BOLT FLANGE W/ FEMALE FLARE  
 Outlet A: LOOSE 2-BOLT FLANGE W/ MALE BALL  
 Length: 55"

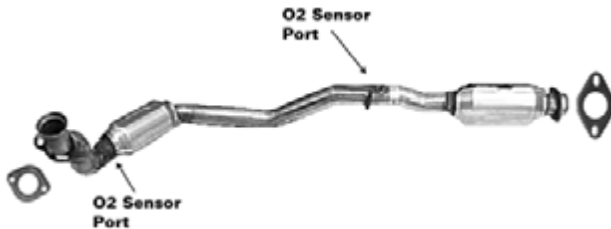

2000-98 8 FORD EXPLORER 5.0L  
 2000-98 8 MERCURY MOUNTAINEER 5.0L

### 4869

Inlet A: LOOSE 2-BOLT FLANGE W/ FEMALE FLARE  
 Outlet A: 2.50" O.D. PIPE  
 Length: 49.75"

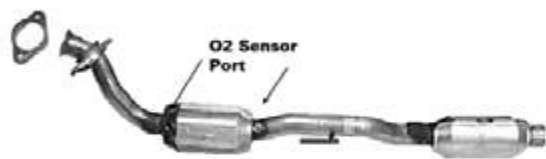

2000-98 8 FORD EXPLORER 5.0L  
 2000-98 8 MERCURY MOUNTAINEER 5.0L

### 4870

Inlet A: LOOSE 2-BOLT FLANGE W/ FEMALE FLARE  
 Outlet A: LOOSE 2-BOLT FLANGE W/ FLAT FLARE  
 Length: 34"



2002-96 8 FORD CROWN VICTORIA (Inc. Police, Taxi,

### 4870 (cont.)

Station Wagon) 4.6L  
 2002-96 8 LINCOLN TOWN CAR 4.6L  
 2002-96 8 MERCURY GRAND MARQUIS FULL SIZE 4.6L

### 4871

Inlet A: LOOSE 2-BOLT FLANGE W/ FEMALE FLARE  
 Outlet A: LOOSE 2-BOLT FLANGE W/ FLAT FLARE  
 Length: 32.75"



2002-96 8 FORD CROWN VICTORIA (Inc. Police, Taxi,  
 Station Wagon) 4.6L  
 2002-96 8 LINCOLN TOWN CAR 4.6L  
 2002-96 8 MERCURY GRAND MARQUIS FULL SIZE 4.6L

### 4873

Inlet A: LOOSE 2-BOLT FLANGE W/ FEMALE FLARE  
 Outlet A: 2.25" O.D. PIPE  
 Length: 54.38"



1995-93 6 CHEVROLET LUMINA APV 3.8L  
 1995-93 6 OLDSMOBILE SILHOUETTE 3.8L  
 1995-93 6 PONTIAC TRANS SPORT 3.8L

### 4874

Inlet A: WELDED 2-BOLT FLANGE  
 Outlet A: WELDED 4-BOLT FLANGE  
 Length: 46.38"

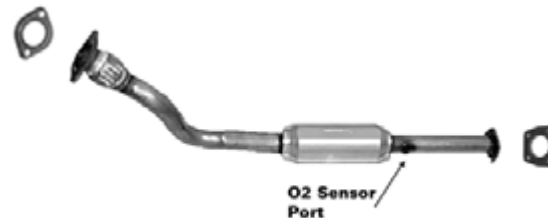

2001-97 6 CHEVROLET LUMINA 3.1L  
 1999-97 6 CHEVROLET MONTE CARLO 3.1L  
 1997 6 OLDSMOBILE CUTLASS 3.1L

# DIRECT FIT

## 4875

Inlet A: LOOSE 2-BOLT FLANGE W/ CHRYSLER FLARE  
 Outlet A: 2.25" O.D. PIPE  
 Length: 33"



- 1995-92 6 CHRYSLER LEBARON 3.0L
- 1993-92 6 DODGE DAYTONA 3.0L
- 1993-92 6 DODGE DYNASTY 3.0L
- 1994-92 6 DODGE SHADOW 3.0L
- 1995-92 6 DODGE SPIRIT 3.0L
- 1995-92 6 PLYMOUTH ACCLAIM 3.0L
- 1994-93 6 PLYMOUTH SUNDANCE, DUSTER 3.0L

## 4876

Inlet A: WELDED 2-BOLT FLANGE  
 Outlet A: WELDED 2-BOLT FLANGE  
 Length: 37.38"



- 2004-97 6 BUICK REGAL 3.8L
- 2005-00 6 CHEVROLET IMPALA FWD 3.8L
- 2005-00 6 CHEVROLET MONTE CARLO 3.8L
- 1999-98 6 OLDSMOBILE INTRIGUE 3.8L
- 2003-97 6 PONTIAC GRAND PRIX 3.8L

## 4877

Inlet A: WELDED 3-BOLT FLANGE  
 Outlet A: WELDED 3-BOLT FLANGE W/ GASKET STUB  
 Length: 38.50"



- 2002-99 4 CHEVROLET CAVALIER 2.4L
- 1999 4 CHEVROLET MALIBU 2.4L
- 2001-99 4 OLDSMOBILE ALERO 2.4L
- 2001-99 4 PONTIAC GRAND AM 2.4L
- 2002-99 4 PONTIAC SUNFIRE 2.4L

## 4878

Inlet A: WELDED 4-BOLT FLANGE W/ STUDS  
 Outlet A: WELDED 2-BOLT FLANGE  
 Length: 41.25"



- 1997-95 4 FORD CONTOUR 2.0L
- 1997-95 4 MERCURY MYSTIQUE 2.0L

## 4879

Inlet A: LOOSE 2-BOLT FLANGE W/ FEMALE FLARE  
 Outlet A: WELDED 3-BOLT FLANGE  
 Length: 32.50"



- 1995-91 6 ACURA LEGEND 3.2L

## 4880

Inlet A: 2.50" I.D. PIPE  
 Outlet A: LOOSE 4-BOLT FLANGE W/ MALE BALL  
 Length: 17"



- 1994-92 6 CHEVROLET BLAZER S-Series 4.3L
- 1994-92 6 GMC S-15 JIMMY 4.3L
- 1994-92 6 OLDSMOBILE BRAVADA 4.3L

## 4881

Inlet A: LOOSE 2-BOLT FLANGE W/ FEMALE FLARE  
 Outlet A: WELDED 2-BOLT FLANGE  
 Length: 28.25"

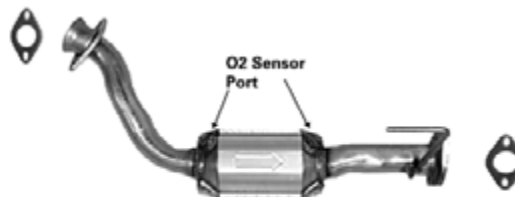

- 1998-96 8 FORD EXPLORER 5.0L
- 1998-97 8 MERCURY MOUNTAINEER 5.0L

### 4882

Inlet A: LOOSE 2-BOLT FLANGE W/ FEMALE FLARE  
 Outlet A: WELDED 2-BOLT FLANGE  
 Length: 35.63"



1998-96 8 FORD EXPLORER 5.0L  
 1998-97 8 MERCURY MOUNTAINEER 5.0L

### 4883

Inlet A: WELDED 2-BOLT FLANGE  
 Outlet A: WELDED 2-BOLT FLANGE  
 Length: 12.63"



1997-96 4 GEO PRIZM 1.6L  
 1997-96 4 GEO PRIZM 1.8L  
 1997-96 4 TOYOTA CELICA 1.8L  
 1997-96 4 TOYOTA COROLLA 1.6L  
 1997-96 4 TOYOTA COROLLA 1.8L

### 4884

Inlet A: LOOSE 2-BOLT FLANGE W/ FEMALE FLARE  
 Inlet B: LOOSE 2-BOLT FLANGE W/ FEMALE FLARE  
 Outlet A: 2.25" O.D. PIPE  
 Length: 54.50"

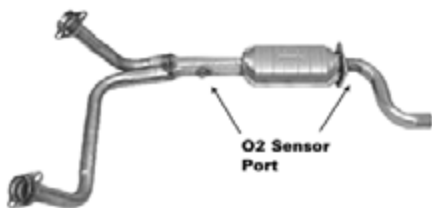

1999-95 6 CHEVROLET CAMARO 3.8L  
 1999-95 6 PONTIAC FIREBIRD, TRANS AM, FORMULA 3.8L

### 4885

Inlet A: LOOSE 2-BOLT FLANGE W/ FEMALE FLARE  
 Inlet B: LOOSE 2-BOLT FLANGE W/ FEMALE FLARE  
 Outlet A: LOOSE 2-BOLT FLANGE W/ MALE BALL  
 Length: 60.50"

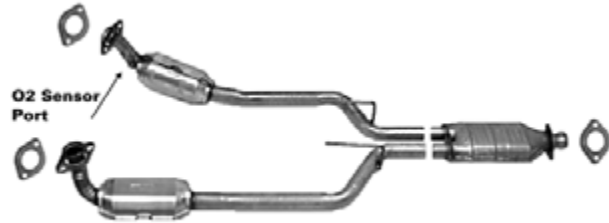

1995-92 6 FORD THUNDERBIRD 3.8L  
 1995-92 6 MERCURY COUGAR 3.8L

### 4886

Inlet A: WELDED 2-BOLT FLANGE  
 Outlet A: WELDED 2-BOLT FLANGE W/ GASKET STUB  
 Length: 54.25"



1996 3 GEO METRO 1.0L  
 1997-96 4 PONTIAC FIREFLY 1.3L

### 4887

Inlet A: WELDED 4-BOLT FLANGE  
 Outlet A: 2.25" O.D. PIPE  
 Length: 68"

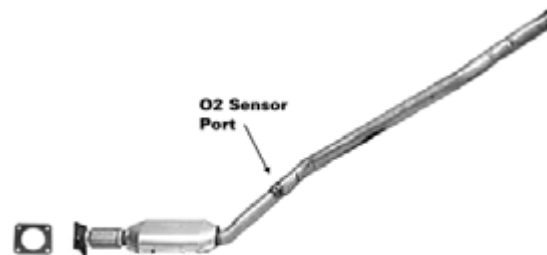

2000 6 CHRYSLER VOYAGER, GRAND VOYAGER 3.0L  
 2000-96 6 DODGE CARAVAN 3.0L  
 2000-96 6 PLYMOUTH VOYAGER 3.0L

# DIRECT FIT

## 4888

Inlet A: LOOSE 2-BOLT FLANGE W/ 2.25" FEMALE FLARE  
 Inlet B: LOOSE 2-BOLT FLANGE W/ 2.25" FEMALE FLARE  
 Outlet A: LOOSE 2-BOLT FLANGE W/ 2" FEMALE FLARE  
 Length: 41"

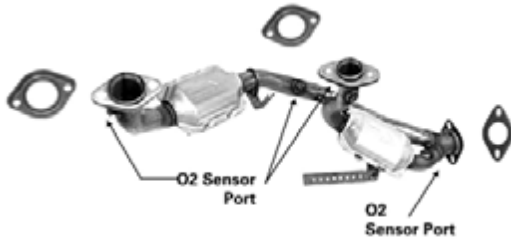

- 1999-96 6 FORD TAURUS 3.0L
- 1999-96 6 MERCURY SABLE 3.0L

## 4889

Inlet A: LOOSE 2-BOLT FLANGE W/ FLAT FLARE  
 Outlet A: LOOSE 3-BOLT FLANGE W/ FLAT FLARE  
 Length: 14.63"

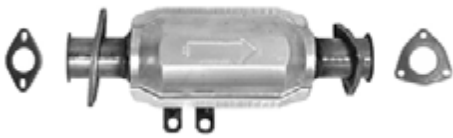

- 1997-95 4 HYUNDAI ACCENT 1.5L
- 1998-96 4 HYUNDAI ELANTRA 1.8L
- 2000-99 4 HYUNDAI ELANTRA 2.0L
- 1997 4 HYUNDAI TIBURON 1.8L
- 2001-98 4 HYUNDAI TIBURON 2.0L
- 1995 4 KIA SPORTAGE All

## 4890

Inlet A: WELDED 4-BOLT FLANGE  
 Outlet A: 2.50" O.D. PIPE  
 Length: 23"



- 1999-97 6 BUICK LESABRE 3.8L
- 1999-97 6 BUICK PARK AVENUE 3.8L
- 1997 6 BUICK RIVIERA 3.8L
- 1999-96 8 OLDSMOBILE AURORA 4.0L
- 1999-97 6 OLDSMOBILE EIGHTY-EIGHT, DELTA 88 3.8L
- 1998-97 6 OLDSMOBILE REGENCY 3.8L
- 1999-97 6 PONTIAC BONNEVILLE 3.8L

## 4890G

Inlet A: WELDED 4-BOLT FLANGE  
 Outlet A: 2.63" O.D. PIPE  
 Length: 23.38"



- 1999-97 6 BUICK LESABRE 3.8L
- 1999-97 6 BUICK PARK AVENUE 3.8L
- 1997 6 BUICK RIVIERA 3.8L
- 1999-96 8 OLDSMOBILE AURORA 4.0L
- 1999-97 6 OLDSMOBILE EIGHTY-EIGHT, DELTA 88 3.8L
- 1998-97 6 OLDSMOBILE REGENCY 3.8L
- 1999-97 6 PONTIAC BONNEVILLE 3.8L

## 4891

Inlet A: LOOSE 2-BOLT FLANGE W/ FEMALE FLARE  
 Outlet A: 1.75" PIPE W/ SPECIAL RING  
 Length: 109"



- 1999-96 4 TOYOTA PASEO 1.5L
- 1997-95 4 TOYOTA TERCEL 1.5L

## 4892

Inlet A: LOOSE 2-BOLT FLANGE W/ CHRYSLER FLARE  
 Outlet A: 2.25" O.D. PIPE  
 Length: 72"



- 1993-92 6 CHRYSLER TOWN & COUNTRY 3.3L
- 1995-94 6 CHRYSLER TOWN & COUNTRY 3.8L
- 1994-91 6 DODGE CARAVAN 3.3L
- 1995-94 6 DODGE CARAVAN 3.8L
- 1995-91 6 PLYMOUTH VOYAGER 3.3L
- 1995-94 6 PLYMOUTH VOYAGER 3.8L



### 4893

Inlet A: WELDED 2-BOLT FLANGE  
 Outlet A: WELDED 2-BOLT FLANGE  
 Length: 15.25"



1995-93 4 SUBARU IMPREZA 1.8L

### 4894

Inlet A: WELDED 2-BOLT FLANGE  
 Outlet A: WELDED 2-BOLT FLANGE W/ GASKET STUB  
 Length: 22"



1997-93 4 SUBARU IMPREZA 1.8L

### 4898

Inlet A: LOOSE 2-BOLT FLANGE W/ SPHERICAL FLARE  
 Outlet A: WELDED 4-BOLT FLANGE  
 Length: 43.25"



1996 6 BUICK REGAL 3.8L  
 1996 6 CHEVROLET LUMINA 3.4L  
 1996 6 CHEVROLET MONTE CARLO 3.4L  
 1996 6 OLDSMOBILE CUTLASS 3.4L  
 1996 6 PONTIAC GRAND PRIX 3.4L

### 4902

Inlet A: LOOSE 2-BOLT FLANGE W/ FEMALE FLARE  
 Outlet A: 1.75" MALE BALL  
 Length: 44.38"



1995-93 5 VOLVO 850 2.4L

### 4912

Inlet A: WELDED 4-BOLT FLANGE  
 Outlet A: 2.38" O.D. PIPE  
 Length: 68.38"



2008-06 4 AUDI A3 2.0L  
 2008-07 4 VOLKSWAGEN EOS 2.0L  
 2008-06 4 VOLKSWAGEN GTI 2.0L  
 2008-06 4 VOLKSWAGEN JETTA 2.0L

### 4917

Inlet A: WELDED 2-BOLT FLANGE  
 Outlet A: WELDED 2-BOLT FLANGE W/ GASKET STUB  
 Length: 33.50"

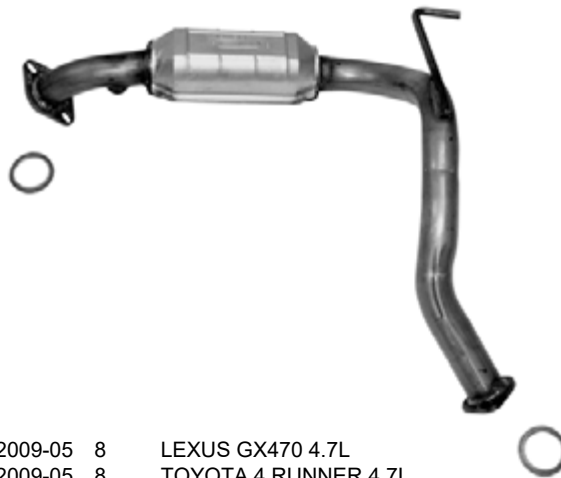

2009-05 8 LEXUS GX470 4.7L  
 2009-05 8 TOYOTA 4 RUNNER 4.7L

**DIRECT FIT**

**4919**

Inlet A: WELDED 2-BOLT FLANGE  
Outlet A: WELDED 2-BOLT FLANGE  
Length: 28"



2013-10 4 FORD TRANSIT CONNECT 2.0L

**4921**

Inlet A: WELDED 3-BOLT FLANGE  
Outlet A: WELDED 2-BOLT FLANGE  
Length: 24.25"



2004-00 4 TOYOTA TACOMA 2.7L

**4926**

Inlet A: WELDED 2-BOLT FLANGE  
Outlet A: WELDED 2-BOLT FLANGE  
Length: 16.50"



2009-07 6 HYUNDAI SANTA FE 3.3L  
2008 6 HYUNDAI SONATA 3.3L  
2012-07 6 HYUNDAI VERACRUZ 3.8L

**4927**

Inlet A: WELDED 2-BOLT FLANGE  
Outlet A: WELDED 3-BOLT FLANGE  
Length: 30



2011-06 4 HONDA CIVIC 1.3L

**4929**

Inlet A: WELDED 4-BOLT FLANGE  
Outlet A: 2.38" O.D. PIPE  
Length: 67"



2008-06 4 VOLKSWAGEN PASSAT 2.0L

**4930**

Inlet A: WELDED 2-BOLT FLANGE  
Outlet A: 2.13" O.D. PIPE  
Length: 16"



2012 4 MAZDA 3 SPORT 2.5L  
2012-10 4 MAZDA 3 2.0L

### 4931

Inlet A: WELDED 2-BOLT FLANGE  
 Outlet A: 2.50" O.D. PIPE  
 Length: 19.75"



2013-12 6 CHEVROLET IMPALA FWD 3.6L

### 4933

Inlet A: WELDED 2-BOLT FLANGE  
 Outlet A: 2" O.D. PIPE  
 Length: 15"



2014-12 4 HYUNDAI ACCENT 1.6L  
 2014-12 4 KIA RIO 1.6L

### 4934

Inlet A: WELDED 4-BOLT FLANGE  
 Outlet A: WELDED 2-BOLT FLANGE  
 Length: 36.25"



2005-01 5 VOLVO S60 2.4L  
 2007-03 5 VOLVO S70/V70 2.4L

### 4941

Inlet A: WELDED 3-BOLT FLANGE  
 Inlet B: WELDED 3-BOLT FLANGE  
 Outlet A: WELDED 2-BOLT FLANGE  
 Length: 47.25"

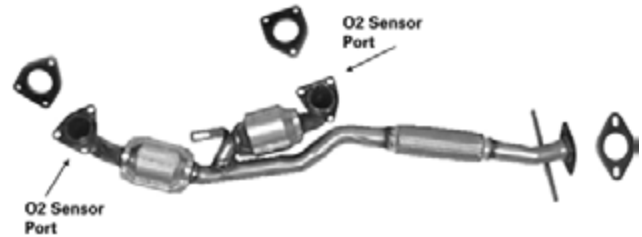

1998-96 6 INFiniti I30 3.0L  
 1999-95 6 NISSAN MAXIMA 3.0L

### 4953

Inlet A: LOOSE 2-BOLT FLANGE W/ CHRYSLER FLARE  
 Outlet A: 2" O.D. PIPE  
 Length: 42"



1988 4 DODGE CARAVAN All  
 1995-89 4 DODGE CARAVAN 2.5L  
 1995-88 4 PLYMOUTH VOYAGER 2.5L

### 4966

Inlet A: WELDED 2-BOLT FLANGE W/ 2.25" FEMALE FLARE  
 Inlet B: LOOSE 2-BOLT FLANGE W/ 2.25" FEMALE FLARE  
 Outlet A: WELDED 2-BOLT FLANGE W/ 2.25" MALE BALL  
 Outlet B: WELDED 2-BOLT FLANGE W/ 2.25" MALE BALL  
 Length: 53.75"

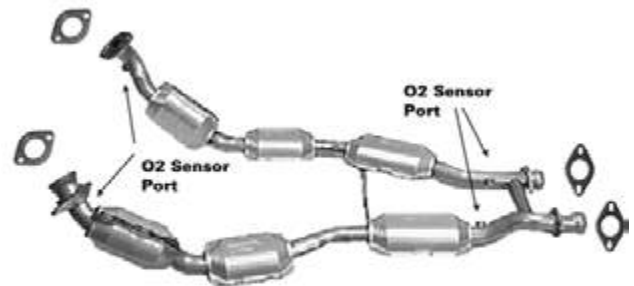

1998-96 8 FORD MUSTANG 4.6L

# DIRECT FIT

## 4967

Inlet A: WELDED 4-BOLT FLANGE  
 Outlet A: 2.25" O.D. PIPE  
 Length: 71"



- 2000-96 6 CHRYSLER TOWN & COUNTRY 3.3L
- 2000-96 6 CHRYSLER TOWN & COUNTRY 3.8L
- 2000 4 CHRYSLER VOYAGER, GRAND VOYAGER 2.4L
- 2000 6 CHRYSLER VOYAGER, GRAND VOYAGER 3.3L
- 2000-96 4 DODGE CARAVAN 2.4L
- 2000-96 6 DODGE CARAVAN 3.3L
- 2000-96 6 DODGE CARAVAN 3.8L
- 1999-96 6 PLYMOUTH VOYAGER 3.8L
- 2000-96 4 PLYMOUTH VOYAGER 2.4L
- 2000-96 6 PLYMOUTH VOYAGER 3.3L

## 4968

Inlet A: WELDED 3-BOLT FLANGE W/ GASKET STUB  
 Outlet A: WELDED 2-BOLT FLANGE  
 Length: 43"



- 1997-96 6 HONDA PASSPORT 3.2L
- 1997-96 6 ISUZU RODEO 3.2L

## 4969

Inlet A: WELDED 2-BOLT FLANGE  
 Inlet B: WELDED 3-BOLT FLANGE W/ GASKET STUB  
 Outlet A: WELDED 2-BOLT FLANGE  
 Length: 49.50"



- 1997-96 6 HONDA PASSPORT 3.2L
- 1997-96 6 ISUZU RODEO 3.2L

## 4971

Inlet A: WELDED 3-BOLT FLANGE W/ GASKET STUB  
 Outlet A: WELDED 2-BOLT FLANGE W/ GASKET STUB  
 Length: 10"



- 2000-98 8 LEXUS GS400 4.0L
- 2007-01 8 LEXUS GS430 4.3L
- 1998 8 LEXUS LS400 4.0L
- 2006-01 8 LEXUS LS430 4.3L
- 2009-02 8 LEXUS SC430 4.3L

## 4972

Inlet A: WELDED 4-BOLT FLANGE W/ GASKET STUB  
 Outlet A: WELDED 2-BOLT FLANGE  
 Length: 23"



- 2004-00 4 FORD FOCUS 2.0L

## 4973

Inlet A: WELDED 2-BOLT FLANGE  
 Outlet A: WELDED 3-BOLT FLANGE  
 Length: 19.50"



- 2003-00 4 HONDA S2000 2.0L
- 2005-04 4 HONDA S2000 2.2L

## 4974

Inlet A: WELDED 2-BOLT FLANGE  
 Outlet A: WELDED 3-BOLT FLANGE  
 Length: 17.63"



- 1999-96 4 ACURA INTEGRA 1.8L

### 4975

Inlet A: LOOSE 2-BOLT FLANGE W/ SPHERICAL FLARE  
 Outlet A: 2.50" O.D. PIPE  
 Length: 38.38"



- 1997-95 6 BUICK LESABRE 3.8L
- 1996-95 6 BUICK PARK AVENUE 3.8L
- 1996-95 6 BUICK RIVIERA 3.8L
- 1996-95 6 OLDSMOBILE 98 3.8L
- 1996-95 6 OLDSMOBILE EIGHTY-EIGHT, DELTA 88 3.8L
- 1996-95 6 PONTIAC BONNEVILLE 3.8L

### 4976

Inlet A: WELDED 2-BOLT FLANGE W/ GASKET STUB  
 Inlet B: WELDED 2-BOLT FLANGE W/ GASKET STUB  
 Outlet A: WELDED 2-BOLT FLANGE  
 Length: 48"



- 1996-95 6 TOYOTA AVALON 3.0L
- 1996-95 6 TOYOTA CAMRY, (Inc. 1998 & Older SOLARA) 3.0L

### 4977

Inlet A: WELDED 3-BOLT FLANGE  
 Outlet A: WELDED 3-BOLT FLANGE  
 Length: 31.50"

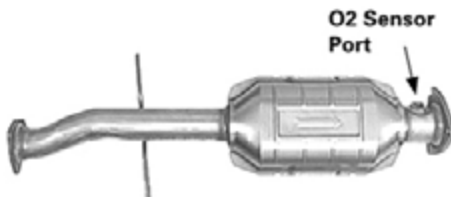

- 1999-98 6 CHEVROLET S-Series (2WD), T-Series (4WD) PICKUP 4.3L
- 1999-98 6 GMC S-Series (2WD), T-Series (4WD) PICKUP (SONOMA) 4.3L
- 1999-98 6 ISUZU PICKUP 4.3L

### 4978

Inlet A: WELDED 2-BOLT FLANGE W/ STUDS  
 Outlet A: WELDED 2-BOLT FLANGE  
 Length: 16.25"



- 2000-98 4 KIA SPORTAGE 2.0L

### 4980

Inlet A: 2-BOLT FLANGE W/ SPHERICAL FLARE  
 Outlet A: 2.15" O.D. PIPE  
 Length: 65"



- 1997 8 MERCEDES-BENZ E420 4.2L

### 4981

Inlet A: LOOSE 2-BOLT FLANGE W/ SPHERICAL FLARE  
 Outlet A: LOOSE 2-BOLT FLANGE W/ FLAT FLARE  
 Length: 66"



- 1997 8 MERCEDES-BENZ E420 4.2L

### 4983

Inlet A: WELDED 2-BOLT FLANGE  
 Inlet B: WELDED 3-BOLT FLANGE  
 Outlet A: WELDED 3-BOLT FLANGE  
 Length: 43"



- 2003-02 6 SATURN VUE 3.0L

# DIRECT FIT

## 4984

Inlet A: WELDED 2-BOLT FLANGE  
 Outlet A: WELDED 3-BOLT FLANGE  
 Length: 24"



2005-03 4 HONDA CIVIC 1.3L

## 4985

Inlet A: WELDED 2-BOLT FLANGE  
 Outlet A: 2.25" O.D. PIPE  
 Length: 21.25"



2010-06 6 MITSUBISHI ECLIPSE 3.8L  
 2009-06 6 MITSUBISHI GALANT 3.8L

## 4986

Inlet A: WELDED 2-BOLT FLANGE  
 Outlet A: WELDED 2-BOLT FLANGE  
 Length: 79.25"



2008-06 4 TOYOTA RAV4 2.4L

## 4987

Inlet A: WELDED 2-BOLT FLANGE  
 Outlet A: WELDED 2-BOLT FLANGE  
 Length: 66.50"



2012-06 6 TOYOTA RAV4 3.5L

## 5000

Inlet A: WELDED 2-BOLT FLANGE  
 Outlet A: WELDED 2-BOLT FLANGE  
 Length: 13"



2008-07 4 HYUNDAI ELANTRA 2.0L  
 2011-10 4 KIA SOUL 2.0L

## 5001

Inlet A: WELDED 2-BOLT FLANGE  
 Outlet A: WELDED 2-BOLT FLANGE  
 Length: 13.50"



2009-06 4 HYUNDAI ACCENT 1.6L  
 2011-06 4 KIA RIO 1.6L  
 2009-06 4 KIA RIO5 1.6L

## 5002

Inlet A: LOOSE 2-BOLT FLANGE W/ SPHERICAL FLARE  
 Outlet A: WELDED 2-BOLT FLANGE  
 Length: 35.75"



2011-03 8 FORD CROWN VICTORIA (Inc. Police, Taxi, Station Wagon) 4.6L  
 2011-03 8 LINCOLN TOWN CAR 4.6L  
 2011-03 8 MERCURY GRAND MARQUIS FULL SIZE 4.6L  
 2004-03 8 MERCURY MARAUDER 4.6L

## 5003

Inlet A: WELDED 2-BOLT FLANGE W/ GASKET STUB  
 Inlet B: WELDED 2-BOLT FLANGE  
 Outlet A: WELDED 2-BOLT FLANGE  
 Length: 49.50"



2003-02 6 JEEP LIBERTY 3.7L

## 5004

Inlet A: WELDED 2-BOLT FLANGE  
 Inlet B: WELDED 2-BOLT FLANGE  
 Outlet A: WELDED 2-BOLT FLANGE  
 Length: 75"



2012-06 6 LEXUS IS250 2.5L

## 5005

Inlet A: WELDED 2-BOLT FLANGE  
 Outlet A: 2.38" O.D. PIPE  
 Length: 49.50"



2015-09 4 TOYOTA VENZA 2.7L

## 5006

Inlet A: WELDED 2-BOLT FLANGE W/ GASKET STUB  
 Outlet A: WELDED 2-BOLT FLANGE W/ GASKET STUB  
 Length: 49.50"



2011-10 4 TOYOTA CAMRY, (Inc. 1998 & Older SOLARA)  
 2.5L

## 5007

Inlet A: WELDED 3-BOLT FLANGE  
 Outlet A: WELDED 2-BOLT FLANGE  
 Length: 49"

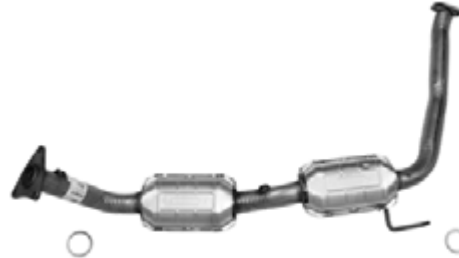

2009-07 8 TOYOTA TUNDRA 4.7L

## 5008

Inlet A: WELDED 4-BOLT FLANGE  
 Outlet A: 2.18" O.D. PIPE  
 Length: 38.25"



2010-06 5 VOLKSWAGEN BEETLE 2.5L

## 5009

Inlet A: WELDED 2-BOLT FLANGE W/ SPHERICAL FLARE  
 Outlet A: WELDED 2-BOLT FLANGE W/ GASKET STUB  
 Length: 86"



2011-06 4 TOYOTA YARIS 1.5L

# DIRECT FIT

## 5010

Inlet A: WELDED 3-BOLT FLANGE W/ GASKET STUB  
Inlet B: WELDED 2-BOLT FLANGE  
Outlet A: WELDED 2-BOLT FLANGE  
Length: 49.50"



- 1999-98 6 ACURA SLX 3.5L
- 2002-98 6 ISUZU TROOPER 3.5L
- 2001-99 6 ISUZU VEHICROSS 3.5L

## 5011

Inlet A: WELDED 3-BOLT FLANGE  
Outlet A: WELDED 2-BOLT FLANGE  
Length: 46.75"



- 2002-98 6 ISUZU TROOPER 3.5L

## 5012

Inlet A: WELDED 3-BOLT FLANGE W/ GASKET STUB  
Outlet A: WELDED 2-BOLT FLANGE  
Length: 48.50"



- 2009-07 4 NISSAN ALTIMA 2.5L

## 5013

Inlet A: WELDED 2-BOLT FLANGE  
Outlet A: WELDED 2-BOLT FLANGE W/ GASKET STUB  
Length: 86.50"

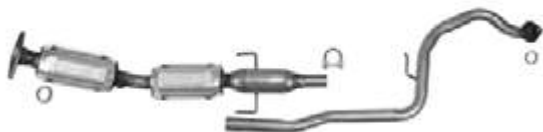

- 2014-12 4 TOYOTA YARIS 1.5L

## 5014

Inlet A: WELDED 4-BOLT FLANGE  
Inlet B: WELDED 4-BOLT FLANGE  
Outlet A: WELDED 2-BOLT FLANGE  
Length: 52.13"



- 2004-02 6 VOLVO S80 2.9L

## 5015

Inlet A: LOOSE 2-BOLT FLANGE W/ SPHERICAL FLARE  
Outlet A: LOOSE 2-BOLT FLANGE W/ SPHERICAL FLARE  
Length: 64"



- 2003-98 6 MERCEDES-BENZ E320 3.2L

## 5016

Inlet A: LOOSE 2-BOLT FLANGE W/ SPHERICAL FLARE  
Outlet A: 2" O.D. PIPE  
Length: 66.25"



- 2003-98 6 MERCEDES-BENZ E320 3.2L

## 5017

Inlet A: WELDED 3-BOLT FLANGE  
Inlet B: WELDED 2-BOLT FLANGE  
Outlet A: WELDED 2-BOLT FLANGE  
Length: 56"



- 2005-04 4 SUBARU LEGACY 2.5L



### 5017 (cont.)

2005-04 4 SUBARU OUTBACK 2.5L

### 5019

Inlet A: WELDED 2-BOLT FLANGE  
 Outlet A: WELDED 2-BOLT FLANGE W/ GASKET STUB  
 Length: 89"



2005-00 4 TOYOTA CELICA 1.8L

### 5022

Inlet A: WELDED 2-BOLT FLANGE  
 Inlet B: WELDED 2-BOLT FLANGE  
 Outlet A: WELDED 2-BOLT FLANGE  
 Length: 79"



2006-03 6 HYUNDAI SANTA FE 3.5L

### 5023

Inlet A: WELDED 2-BOLT FLANGE W/ GASKET STUB  
 Outlet A: WELDED 2-BOLT FLANGE  
 Length: 56.75"



2006-03 4 TOYOTA CAMRY, (Inc. 1998 & Older SOLARA)  
 2.4L

### 5024

Inlet A: WELDED 3-BOLT FLANGE W/ GASKET STUB  
 Outlet A: WELDED 2-BOLT FLANGE  
 Length: 48.50"



2015-07 4 NISSAN ALTIMA 2.5L

### 5026

Inlet A: WELDED 3-BOLT FLANGE  
 Outlet A: WELDED 2-BOLT FLANGE  
 Length: 50.38"



2015-11 4 CHEVROLET CRUZE 1.4L

### 5032

Inlet A: WELDED 2-BOLT FLANGE  
 Inlet B: LOOSE 2-BOLT FLANGE W/ FLARE  
 Outlet A: LOOSE 2-BOLT FLANGE W/ MALE BALL  
 Outlet B: 2 BOLT LOOSE FLANGE W/ FLARE  
 Length: 55"



2004 8 FORD MUSTANG 4.6L

### 5033

Inlet A: WELDED 2-BOLT FLANGE  
 Outlet A: WELDED 2-BOLT FLANGE  
 Length: 81.50"



2010-05 4 SCION TC 2.4L

### 5034

Inlet A: WELDED 2-BOLT FLANGE  
 Outlet A: 2.25" O.D. PIPE  
 Length: 51"



2007 6 DODGE CHARGER 2.7L  
 2007 6 DODGE MAGNUM 2.7L

# DIRECT FIT

## 5035

Inlet A: WELDED 2-BOLT FLANGE  
Outlet A: 2.25" O.D. PIPE  
Length: 51.13"



2007 6 DODGE CHARGER 2.7L  
2007 6 DODGE MAGNUM 2.7L

## 5036

Inlet A: WELDED 2-BOLT FLANGE  
Inlet B: WELDED 2-BOLT FLANGE  
Outlet A: WELDED 2-BOLT FLANGE  
Length: 72"



2001-99 6 TOYOTA SIENNA 3.0L

## 5037

Inlet A: WELDED 3-BOLT FLANGE  
Inlet B: WELDED 3-BOLT FLANGE  
Outlet A: 2.50" O.D. PIPE  
Length: 66"



2008-06 6 VOLKSWAGEN PASSAT 3.6L

## 5038

Inlet A: WELDED 3-BOLT FLANGE  
Outlet A: WELDED 2-BOLT FLANGE  
Length: 51.75"



2004 4 MITSUBISHI LANCER 2.4L

## 5039

Inlet A: WELDED 2-BOLT FLANGE  
Outlet A: 1.90" O.D. PIPE  
Length: 78.50"



2009-07 4 SUZUKI SX4 2.0L

## 5040

Inlet A: WELDED 2-BOLT FLANGE  
Outlet A: 2.38" O.D. PIPE  
Length: 48"



2003-99 8 BMW 540 4.4L  
2001-99 8 BMW 740 4.4L

## 5041

Inlet A: WELDED 2-BOLT FLANGE  
Outlet A: 2.38" O.D. PIPE  
Length: 48"



2003-99 8 BMW 540 4.4L  
2001-99 8 BMW 740 4.4L

## 5042

Inlet A: LOOSE 2-BOLT FLANGE W/ FLARE  
Outlet A: LOOSE 2-BOLT FLANGE W/ FLARE  
Length: 67.25"



2005-04 6 MERCEDES-BENZ E320 3.2L

## 5043

Inlet A: WELDED 4-BOLT FLANGE  
Outlet A: WELDED 2-BOLT FLANGE  
Length: 52"



2003-01 4 ISUZU RODEO SPORT 2.2L  
2003-01 4 ISUZU RODEO 2.2L

### 5044

Inlet A: LOOSE 2-BOLT FLANGE W/ FLARE  
 Outlet A: 2.19" O.D. PIPE  
 Length: 70"



2005-04 6 MERCEDES-BENZ E320 3.2L

### 5045

Inlet A: WELDED 3-BOLT FLANGE  
 Inlet B: WELDED 3-BOLT FLANGE  
 Outlet A: 2.50" O.D. PIPE  
 Length: 70"



2009-06 6 AUDI A3 QUATTRO 3.2L

### 5046

Inlet A: WELDED 2-BOLT FLANGE  
 Outlet A: WELDED 2-BOLT FLANGE  
 Length: 82.50"



2012-08 4 SCION XD 1.8L

### 5047

Inlet A: WELDED 5-BOLT FLANGE  
 Inlet B: WELDED 2-BOLT FLANGE  
 Outlet A: WELDED 2-BOLT FLANGE  
 Length: 62.50"



2007-06 6 SUBARU B9 TRIBECA 3.0L  
 2007-05 6 SUBARU OUTBACK 3.0L

### 5048

Inlet A: WELDED 5-BOLT FLANGE  
 Outlet A: WELDED 2-BOLT FLANGE  
 Length: 51.25"



2007-06 6 SUBARU B9 TRIBECA 3.0L  
 2007-05 6 SUBARU OUTBACK 3.0L

### 5049

Inlet A: WELDED 2-BOLT FLANGE  
 Outlet A: 1.75" O.D. PIPE W/ GASKET STUD  
 Length: 98"



2006-03 4 PONTIAC VIBE 1.8L  
 2006-03 4 TOYOTA MATRIX 1.8L

### 5050

Inlet A: LOOSE 2-BOLT FLANGE W/ FLARE  
 Outlet A: LOOSE 2-BOLT W/ MALE BALL  
 Length: 67"



2005-03 6 MERCEDES-BENZ E320 3.2L

### 5051

Inlet A: LOOSE 2-BOLT FLANGE W/ FLARE  
 Outlet A: 2.19" O.D. PIPE  
 Length: 72"



2005-03 6 MERCEDES-BENZ E320 3.2L

### 5052

Inlet A: WELDED 3-BOLT FLANGE W/ FLARE  
 Outlet A: 2" O.D. PIPE  
 Length: 63.75"



2001-00 6 AUDI A4 2.8L

### 5053

Inlet A: WELDED 3-BOLT FLANGE W/ FLARE  
 Outlet A: 2" O.D. PIPE  
 Length: 50"



2001-00 6 AUDI A4 2.8L

# DIRECT FIT

## 5054

Inlet A: WELDED 3-BOLT FLANGE  
Outlet A: WELDED 2-BOLT FLANGE  
Length: 68"



2013-10 8 TOYOTA TUNDRA 5.7L

## 5055

Inlet A: WELDED 2-BOLT FLANGE  
Outlet A: WELDED 2-BOLT FLANGE W/GASKET STUB  
Length: 90"



2003 4 PONTIAC VIBE 1.8L  
2003 4 TOYOTA MATRIX 1.8L

## 5056

Inlet A: WELDED 2-BOLT FLANGE  
Inlet B: WELDED 2-BOLT FLANGE  
Outlet A: 2.50" I.D. PIPE  
Length: 59.50"



1997-95 8 LEXUS LS400 4.0L

## 5057

Inlet A: WELDED 3-BOLT FLANGE  
Outlet A: WELDED 2-BOLT FLANGE  
Length: 59.25"



2007-06 4 SUBARU LEGACY 2.5L  
2007-06 4 SUBARU OUTBACK 2.5L

## 5058

Inlet A: WELDED 2-BOLT FLANGE  
Outlet A: WELDED 2-BOLT FLANGE  
Length: 105"



2013-11 4 SCION TC 2.5L

## 5059

Inlet A: LOOSE 2-BOLT FLANGE W/ FLARE  
Inlet B: LOOSE 2-BOLT FLANGE W/ FLARE  
Outlet A: LOOSE 3-BOLT FLANGE W/ FLARE  
Length: 62"



2003-98 6 MERCEDES-BENZ CLK320 3.2L  
2003-99 8 MERCEDES-BENZ CLK430 4.3L  
2002-01 8 MERCEDES-BENZ CLK55 AMG 5.5L

## 5060

Inlet A: WELDED 3-BOLT FLANGE  
Inlet B: WELDED 3-BOLT FLANGE  
Outlet A: 2.38" O.D. PIPE  
Length: 73"



2008 6 VOLKSWAGEN R32 3.2L

## 5061

Inlet A: WELDED 2-BOLT FLANGE  
Outlet A: WELDED 2-BOLT FLANGE  
Length: 75.25"



2015-12 4 HYUNDAI VELOSTER 1.6L

## 5062

Inlet A: LOOSE 3-BOLT FLANGE W/ FLARE  
Outlet A: 1.97" O.D. PIPE  
Length: 51.38"



2005-03 8 AUDI ALLROAD QUATTRO 4.2L

### 5063

Inlet A: LOOSE 3-BOLT FLANGE W/ FLARE  
 Outlet A: 1.97" O.D. PIPE  
 Length: 50.50"



2005-03 8 AUDI ALLROAD QUATTRO 4.2L

### 5064

Inlet A: WELDED 2-BOLT FLANGE  
 Inlet B: WELDED 2-BOLT FLANGE  
 Outlet A: WELDED 2-BOLT FLANGE W/GASKET STUB  
 Length: 75.75"



2012-06 6 LEXUS IS350 3.5L

### 5065

Inlet A: WELDED 2-BOLT FLANGE  
 Outlet A: WELDED 2-BOLT FLANGE W/GASKET STUB  
 Length: 104"



2009-08 4 MITSUBISHI OUTLANDER 2.4L

### 5066

Inlet A: WELDED 3-BOLT FLANGE  
 Outlet A: 2" O.D. PIPE  
 Length: 67"



2008-05 6 AUDI A6 3.2L

### 5067

Inlet A: WELDED 3-BOLT FLANGE  
 Outlet A: 2" O.D. PIPE  
 Length: 65.50"



2008-05 6 AUDI A6 3.2L

### 5068

Inlet A: LOOSE 2-BOLT FLANGE W/ FLARE  
 Outlet A: 2.16" O.D. PIPE  
 Length: 51"



2012-06 6 MERCEDES-BENZ R350 3.5L

### 5069

Inlet A: WELDED 3-BOLT FLANGE  
 Outlet A: WELDED 3-BOLT FLANGE  
 Length: 49"



2007 4 SATURN VUE 2.4L

### 5070

Inlet A: WELDED 2-BOLT FLANGE  
 Inlet B: WELDED 2-BOLT FLANGE  
 Outlet A: WELDED 2-BOLT FLANGE  
 Length: 54.63"



2010 6 BUICK ALLURE 3.0L  
 2010 6 BUICK LACROSSE 3.0L

### 5101

Inlet A: WELDED 3-BOLT FLANGE  
 Outlet A: 2.13" O.D. PIPE  
 Length: 43.75"



2005-02 6 AUDI A4 3.0L

# DIRECT FIT

## 5102

Inlet A: WELDED 3-BOLT FLANGE  
 Outlet A: 2.13" O.D. PIPE  
 Length: 45.50"



2005-02 6 AUDI A4 3.0L

## 5103

Inlet A: LOOSE 2-BOLT FLANGE W/ SPHERICAL FLARE  
 Outlet A: 2" O.D. PIPE  
 Length: 64.38"



2002-98 8 MERCEDES-BENZ E430 4.3L

## 5104

Inlet A: WELDED 2-BOLT FLANGE  
 Outlet A: WELDED 2-BOLT FLANGE W/ GASKET STUB  
 Length: 31.13"



2012-07 4 NISSAN SENTRA 2.0L

## 5106

Inlet A: WELDED 2-BOLT FLANGE W/ SPHERICAL FLARE  
 Outlet A: 2.24" O.D. PIPE  
 Length: 30.63"



2013-09 4 MAZDA 6 2.5L

## 5107

Inlet A: WELDED 3-BOLT FLANGE  
 Inlet B: WELDED 3-BOLT FLANGE  
 Outlet A: WELDED 2-BOLT FLANGE  
 Length: 26"



2010-06 4 SUBARU FORESTER 2.5L  
 2011-06 4 SUBARU IMPREZA 2.5L  
 2009-06 4 SUBARU LEGACY 2.5L  
 2011-06 4 SUBARU OUTBACK 2.5L

## 5109

Inlet A: WELDED 2-BOLT FLANGE  
 Outlet A: WELDED 2-BOLT FLANGE W/ GASKET STUB  
 Length: 30"



2016-11 4 NISSAN JUKE 1.6L

## 5115

Inlet A: WELDED 2-BOLT FLANGE  
 Outlet A: 2.50" O.D. PIPE W/ SPHERICAL BALL  
 Length: 20.25"



2014-11 8 FORD MUSTANG 5.0L

### 5116

Inlet A: WELDED 2-BOLT FLANGE  
 Outlet A: 2.50" O.D. PIPE W/ SPHERICAL BALL  
 Length: 20.50"



2014-11 8 FORD MUSTANG 5.0L

### 5121

Inlet A: WELDED 2-BOLT FLANGE W/ SPHERICAL FLARE  
 Outlet A: 2.42" O.D. PIPE  
 Length: 19.25"



2003-99 6 LEXUS RX300 3.0L

### 5118

Inlet A: WELDED 2-BOLT FLANGE W/ SPHERICAL FLARE  
 Outlet A: WELDED 3-BOLT FLANGE W/ GASKET STUB  
 Length: 19.50"



2012-10 4 MAZDA CX-7 2.5L

### 5124

Inlet A: WELDED 2-BOLT FLANGE  
 Outlet A: 2.25" O.D. PIPE  
 Length: 22.38"



2010-09 4 PONTIAC VIBE 2.4L  
 2010-09 4 TOYOTA COROLLA 2.4L  
 2013-09 4 TOYOTA MATRIX 2.4L

### 5127

Inlet A: WELDED 2-BOLT FLANGE W/ SPHERICAL FLARE  
 Outlet A: 2.24" O.D. PIPE  
 Length: 26.38"



2011-04 6 MITSUBISHI ENDEAVOR 3.8L

# DIRECT FIT

## 5128

Inlet A: WELDED 2-BOLT FLANGE W/ SPHERICAL FLARE  
 Outlet A: WELDED 3-BOLT FLANGE  
 Length: 26.75"



2012-07 4 ACURA RDX 2.3L

## 5129

Inlet A: WELDED 2-BOLT FLANGE  
 Outlet A: WELDED 2-BOLT FLANGE  
 Length: 11"



2009-07 6 KIA SORENTO 3.8L  
 2009-08 6 KIA SORENTO 3.3L

## 5131

Inlet A: WELDED 2-BOLT FLANGE  
 Outlet A: WELDED 2-BOLT FLANGE  
 Length: 16.50"



2008-06 4 HYUNDAI ELANTRA 2.0L

## 5132

Inlet A: WELDED 2-BOLT FLANGE  
 Outlet A: WELDED 2-BOLT FLANGE  
 Length: 15.88"



2014-09 4 HYUNDAI SONATA 2.4L  
 2013-10 4 KIA FORTE KOUP 2.4L  
 2014-10 4 KIA FORTE KOUP 2.0L  
 2013-10 4 KIA FORTE 2.0L  
 2013-10 4 KIA FORTE 2.4L  
 2014-13 4 KIA OPTIMA 2.4L

## 5134

Inlet A: WELDED 2-BOLT FLANGE  
 Outlet A: WELDED 2-BOLT FLANGE  
 Length: 13.13"



2010-09 6 HYUNDAI SONATA 3.3L

## 5142

Inlet A: WELDED 2-BOLT FLANGE  
 Inlet B: WELDED 2-BOLT FLANGE  
 Outlet A: WELDED 2-BOLT FLANGE  
 Length: 47"



2005-01 8 LEXUS GS430 4.3L



### 5143

Inlet A: LOOSE 2-BOLT FLANGE W/ FLARE  
 Outlet A: LOOSE 2-BOLT FLANGE W/ FLARE  
 Length: 60"



2006-03 8 MERCEDES-BENZ S430 4.3L  
 2006-03 8 MERCEDES-BENZ S500 5.0L

### 5144

Inlet A: LOOSE 2-BOLT FLANGE W/ FLARE  
 Outlet A: 2.13" O.D. PIPE  
 Length: 64.50"



2006-03 8 MERCEDES-BENZ S430 4.3L  
 2006-03 8 MERCEDES-BENZ S500 5.0L

### 5145

Inlet A: WELDED 3-BOLT FLANGE  
 Inlet B: WELDED 3-BOLT FLANGE  
 Outlet A: WELDED 2-BOLT FLANGE  
 Length: 43"



2005-02 6 VOLVO S80 2.9L

### 5146

Inlet A: WELDED 2-BOLT FLANGE  
 Inlet B: WELDED 2-BOLT FLANGE  
 Outlet A: WELDED 2-BOLT FLANGE  
 Length: 43"



2010-02 8 LEXUS SC430 4.3L

### 5147

Inlet A: WELDED 2-BOLT FLANGE  
 Outlet A: 2.15" I.D. PIPE  
 Length: 40.25"



2005-04 4 TOYOTA RAV4 2.4L

### 5148

Inlet A: WELDED 4-BOLT FLANGE  
 Outlet A: 1.80" I.D. PIPE  
 Length: 30"



2002-00 4 DODGE NEON 2.0L  
 2001-00 4 PLYMOUTH NEON 2.0L

### 5149

Inlet A: 45 DEGREE FLARE  
 Outlet A: 3" O.D. PIPE  
 Length: 30"



2006-03 10 DODGE VIPER 8.3L

### 5150

Inlet A: 45 DEGREE FLARE  
 Outlet A: 3" O.D. PIPE  
 Length: 29.25"



2006-03 10 DODGE VIPER 8.3L

### 5151

Inlet A: 45 DEGREE FLARE  
 Outlet A: 2.25" O.D. PIPE  
 Length: 44"



2004-99 6 CHRYSLER 300M 3.5L

# DIRECT FIT

## 5152

Inlet A: WELDED 4-BOLT FLANGE  
Outlet A: 2.25" O.D. PIPE  
Length: 33.50"



2005-01 4 DODGE NEON 2.0L

## 5156

Inlet A: WELDED 2-BOLT FLANGE  
Outlet A: WELDED 2-BOLT FLANGE  
Length: 31"



2002-01 6 TOYOTA 4 RUNNER 3.4L

## 5153

Inlet A: WELDED 3-BOLT FLANGE  
Outlet A: WELDED 2-BOLT FLANGE  
Length: 25.50"



2004-02 4 FORD FOCUS 2.0L

## 5157

Inlet A: WELDED 3-BOLT FLANGE  
Outlet A: WELDED 2-BOLT FLANGE  
Length: 48"



2002-01 5 VOLVO S60 2.3L  
2002-01 5 VOLVO S60 2.4L  
2002-01 5 VOLVO S70/V70 2.3L

## 5154

Inlet A: WELDED 2-BOLT FLANGE W/ FEMALE FLARE  
Outlet A: WELDED 3-BOLT FLANGE  
Length: 33"



1998-96 6 ACURA TL 3.2L

## 5158

Inlet A: WELDED 3-BOLT FLANGE  
Outlet A: WELDED 2-BOLT FLANGE  
Length: 10"



1998 8 LEXUS LS400 4.0L

## 5155

Inlet A: WELDED 3-BOLT FLANGE  
Inlet B: WELDED 3-BOLT FLANGE  
Outlet A: WELDED 2-BOLT FLANGE  
Length: 39"



1999 6 INFiniti I30 3.0L  
1999 6 NISSAN MAXIMA 3.0L

## 5159

Inlet A: WELDED 2-BOLT FLANGE  
Outlet A: WELDED 2-BOLT FLANGE  
Length: 37.25"



2000-99 4 MAZDA PROTÉGÉ 1.8L

### 5160

Inlet A: WELDED 4-BOLT FLANGE  
 Inlet B: WELDED 4-BOLT FLANGE  
 Outlet A: WELDED 2-BOLT FLANGE  
 Length: 41.25"



2001-99 6 VOLVO S80 2.9L

### 5161

Inlet A: LOOSE 3-BOLT FLANGE W/ FLARE  
 Outlet A: FEMALE FLARE  
 Length: 35"



2002-00 4 SAAB 9-3 2.0L  
 2002-00 4 SAAB 9-3 2.3L

### 5162

Inlet A: WELDED 2-BOLT FLANGE  
 Outlet A: 2" I.D. PIPE  
 Length: 48"



2006 6 BMW 325 3.0L  
 2012-07 6 BMW 328 3.0L  
 2006 6 BMW 330 3.0L

### 5163

Inlet A: WELDED 2-BOLT FLANGE  
 Outlet A: 2" I.D. PIPE  
 Length: 48"



2006 6 BMW 325 3.0L  
 2012-07 6 BMW 328 3.0L  
 2006 6 BMW 330 3.0L

### 5164

Inlet A: WELDED 6-BOLT FLANGE  
 Outlet A: 2.50" O.D. PIPE  
 Length: 41.25"



2006-04 6 AUDI TT 3.2L  
 2004 6 VOLKSWAGEN GOLF 3.2L

### 5165

Inlet A: WELDED 3-BOLT FLANGE  
 Outlet A: WELDED 2-BOLT FLANGE W/GASKET STUB  
 Length: 21"



2009-07 4 SUZUKI SX4 2.0L

### 5166

Inlet A: WELDED 4-BOLT FLANGE  
 Outlet A: 2.17" O.D. PIPE  
 Length: 42.25"



2005-04 4 VOLKSWAGEN JETTA 2.0L

### 5167

Inlet A: WELDED 4-BOLT FLANGE  
 Inlet B: WELDED 4-BOLT FLANGE  
 Outlet A: WELDED 2-BOLT FLANGE  
 Length: 38.50"



2001-00 6 VOLVO S80 2.8L

# DIRECT FIT

## 5168

Inlet A: WELDED 5-BOLT FLANGE  
Outlet A: WELDED 2-BOLT FLANGE  
Length: 20.50"



2012-08 4 SUBARU IMPREZA 2.5L

## 5169

Inlet A: WELDED 2-BOLT FLANGE  
Outlet A: WELDED 2-BOLT FLANGE  
Length: 34"



2013-09 4 SUBARU FORESTER 2.5L  
2014-08 4 SUBARU IMPREZA 2.5L  
2009-05 4 SUBARU LEGACY 2.5L  
2009-05 4 SUBARU OUTBACK 2.5L

## 5170

Inlet A: WELDED 2-BOLT FLANGE  
Outlet A: WELDED 2-BOLT FLANGE  
Length: 28"



2000-99 6 MITSUBISHI MONTERO SPORT 3.0L

## 5171

Inlet A: WELDED 2-BOLT FLANGE  
Outlet A: WELDED 2-BOLT FLANGE  
Length: 29"



2000-99 6 MITSUBISHI MONTERO SPORT 3.5L

## 5172

Inlet A: WELDED 2-BOLT FLANGE  
Inlet B: LOOSE 2-BOLT FLANGE W/ MALE BALL  
Outlet A: WELDED 2-BOLT FLANGE  
Length: 24.88"



2000-99 6 MITSUBISHI MONTERO SPORT 3.5L

## 5173

Inlet A: WELDED 2-BOLT FLANGE  
Outlet A: 2.25" O.D. PIPE  
Length: 22.75"



2005-04 6 MITSUBISHI GALANT 3.8L

## 5174

Inlet A: LOOSE 3-BOLT FLANGE W/ FLARE  
Outlet A: WELDED 3-BOLT FLANGE  
Length: 19.25"



2007-04 8 VOLKSWAGEN TOUAREG 4.2L

## 5175

Inlet A: LOOSE 3-BOLT FLANGE W/ FLARE  
Outlet A: WELDED 3-BOLT FLANGE  
Length: 22.50"



2007-04 8 VOLKSWAGEN TOUAREG 4.2L

## 5176

Inlet A: WELDED 3-BOLT FLANGE  
Outlet A: 2.38" O.D. PIPE  
Length: 28.50"



2007-04 8 VOLKSWAGEN TOUAREG 4.2L

### 5177

Inlet A: WELDED 3-BOLT FLANGE  
 Outlet A: 2.38" O.D. PIPE  
 Length: 28.13"



2007-04 8 VOLKSWAGEN TOUAREG 4.2L

### 5178

Inlet A: WELDED 3-BOLT FLANGE  
 Outlet A: 2.50" O.D. PIPE  
 Length: 42.50"



2011-03 4 SAAB 9-3 2.0L

### 5179

Inlet A: WELDED 3-BOLT FLANGE W/GASKET STUBS  
 Outlet A: WELDED 2-BOLT FLANGE W/GASKET STUB  
 Length: 25.25"



2005-00 4 TOYOTA MR2 SPYDER 1.8L

### 5180

Inlet A: WELDED 3-BOLT FLANGE  
 Outlet A: WELDED 3-BOLT FLANGE  
 Length: 35"



2007 6 AUDI Q7 3.6L  
 2007 6 VOLKSWAGEN TOUAREG 3.6L

### 5181

Inlet A: WELDED 3-BOLT FLANGE  
 Outlet A: WELDED 3-BOLT FLANGE  
 Length: 40"



2007 6 AUDI Q7 3.6L

### 5181 (cont.)

2007 6 VOLKSWAGEN TOUAREG 3.6L

### 5182

Inlet A: WELDED 6-BOLT FLANGE  
 Outlet A: 2.17" O.D. PIPE  
 Outlet B: 2.17" O.D. PIPE  
 Length: 39"



2007 6 VOLKSWAGEN TOUAREG 3.6L

### 5183

Inlet A: WELDED 4-BOLT FLANGE  
 Outlet A: 1.95" O.D. PIPE  
 Length: 44.75"



2004-00 6 AUDI A6 2.7L  
 2005-01 6 AUDI ALLROAD QUATTRO 2.7L

### 5184

Inlet A: WELDED 4-BOLT FLANGE  
 Outlet A: 1.95" O.D. PIPE  
 Length: 42"



2004-00 6 AUDI A6 2.7L  
 2005-01 6 AUDI ALLROAD QUATTRO 2.7L

### 5185

Inlet A: WELDED 2-BOLT FLANGE W/GASKET STUB  
 Outlet A: WELDED 2-BOLT FLANGE  
 Length: 13"



2008-07 8 INFiniti FX45 4.5L

# DIRECT FIT

## 5186

Inlet A: WELDED 2-BOLT FLANGE W/GASKET STUB  
 Outlet A: WELDED 2-BOLT FLANGE  
 Length: 13"



2008-07 8 INFINITI FX45 4.5L

## 5187

Inlet A: WELDED 2-BOLT FLANGE  
 Inlet B: WELDED 2-BOLT FLANGE  
 Outlet A: WELDED 2-BOLT FLANGE  
 Length: 47"



1994-90 8 LEXUS LS400 4.0L  
 1997-92 8 LEXUS SC400 4.0L

## 5188

Inlet A: WELDED 3-BOLT FLANGE  
 Outlet A: 2.18" O.D. PIPE  
 Length: 46"



2004-98 4 VOLKSWAGEN BEETLE 1.9L  
 2004-99 4 VOLKSWAGEN GOLF 1.9L  
 2004-99 4 VOLKSWAGEN JETTA 1.9L

## 5189

Inlet A: WELDED 4-BOLT FLANGE  
 Outlet A: 2.14" O.D. PIPE  
 Length: 47"



2000 5 VOLVO S70/V70 2.4L

## 5190

Inlet A: LOOSE 3-BOLT FLANGE W/ FLARE  
 Outlet A: LOOSE 3-BOLT FLANGE W/ FLARE  
 Length: 21.44"



2003-98 6 MERCEDES-BENZ CLK320 3.2L  
 2003-99 8 MERCEDES-BENZ CLK430 4.3L  
 2002-01 8 MERCEDES-BENZ CLK55 AMG 5.5L

## 5191

Inlet A: LOOSE 3-BOLT FLANGE W/ FLARE  
 Outlet A: 2.16" O.D. PIPE  
 Length: 44.50"



2009-04 8 AUDI S4 4.2L

## 5192

Inlet A: LOOSE 3-BOLT FLANGE W/ FLARE  
 Outlet A: 2.16" O.D. PIPE  
 Length: 45.50"



2009-04 8 AUDI S4 4.2L

## 5193

Inlet A: WELDED 2-BOLT FLANGE  
 Outlet A: 2.25" O.D. PIPE  
 Length: 41.19"



2009-07 6 MITSUBISHI OUTLANDER 3.0L

## 5194

Inlet A: WELDED 2-BOLT FLANGE W/FLARE  
 Outlet A: 2.23" O.D. PIPE  
 Length: 21.13"

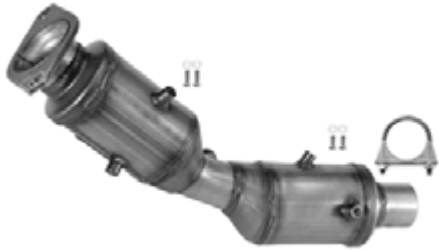

2014-12 4 TOYOTA PRIUS V 1.8L  
 2015-10 4 TOYOTA PRIUS 1.8L

## 5195

Inlet A: WELDED 4-BOLT FLANGE  
 Outlet A: WELDED 2-BOLT FLANGE  
 Length: 31.25"



2010-07 5 VOLVO C30 2.4L  
 2010-04 5 VOLVO S40/V40 2.4L  
 2010-05 5 VOLVO V50 2.4L

## 5196

Inlet A: WELDED 2-BOLT FLANGE  
 Outlet A: WELDED 2-BOLT FLANGE W/GASKET STUB  
 Length: 38.13"



2013 4 SCION FR-S 2.0L

## 5197

Inlet A: WELDED 2-BOLT FLANGE  
 Outlet A: 2.03" O.D. PIPE  
 Length: 22"



2006-04 4 TOYOTA HIGHLANDER 2.4L

## 5198

Inlet A: WELDED 4-BOLT FLANGE  
 Outlet A: 1.97" O.D. PIPE  
 Length: 44"



2004-03 6 AUDI A6 2.7L  
 2005-03 6 AUDI ALLROAD QUATTRO 2.7L

## 5199

Inlet A: WELDED 4-BOLT FLANGE  
 Outlet A: 1.97" O.D. PIPE  
 Length: 43.50"



2004-03 6 AUDI A6 2.7L  
 2005-03 6 AUDI ALLROAD QUATTRO 2.7L

## 5200

Inlet A: WELDED 2-BOLT FLANGE  
 Outlet A: WELDED 2-BOLT FLANGE W/GASKET STUB  
 Length: 45.75"



2008-06 6 SUZUKI VITARA, GRAND VITARA 2.7L

## 5201

Inlet A: WELDED 3-BOLT FLANGE  
 Outlet A: 2.50" O.D. PIPE  
 Length: 42.25"



2009-06 6 SAAB 9-3 2.8L

# DIRECT FIT

## 5202

Inlet A: WELDED 2-BOLT FLANGE W/FLARE  
Outlet A: WELDED 3-BOLT FLANGE  
Length: 26"



2014-10 4 HONDA INSIGHT 1.3L

## 5203

Inlet A: WELDED 2-BOLT FLANGE W/FLARE  
Outlet A: LOOSE 2-BOLT FLANGE W/GASKET STUB  
Length: 25.50"



2012-09 4 NISSAN SENTRA 2.0L

## 5204

Inlet A: WELDED 2-BOLT FLANGE  
Outlet A: 2.13" I.D. PIPE  
Length: 35"



2008 4 MITSUBISHI LANCER 2.0L

## 5205

Inlet A: LOOSE 2-BOLT FLANGE W/ FLARE  
Outlet A: 2.50" O.D. PIPE  
Length: 51"



2011-06 6 MERCEDES-BENZ ML350 3.5L

## 5206

Inlet A: LOOSE 2-BOLT FLANGE W/ FLARE  
Outlet A: 2.17" O.D. PIPE  
Length: 52.13"



2011-06 6 MERCEDES-BENZ ML350 3.5L

## 5207

Inlet A: WELDED 2-BOLT FLANGE  
Inlet B: WELDED 2-BOLT FLANGE  
Outlet A: WELDED 2-BOLT FLANGE  
Length: 25.75"

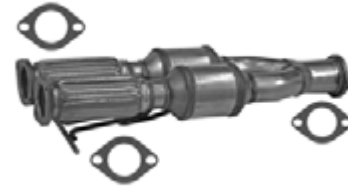

2011-05 8 VOLVO XC90 4.4L

## 5208

Inlet A: WELDED 3-BOLT FLANGE W/GASKET STUB  
Inlet B: WELDED 3-BOLT FLANGE W/GASKET STUB  
Outlet A: WELDED 2-BOLT FLANGE  
Length: 41.50"



2009 6 NISSAN MAXIMA 3.5L

## 5209

Inlet A: WELDED 2-BOLT FLANGE  
Outlet A: WELDED 2-BOLT FLANGE  
Length: 44"



2006-04 6 SUZUKI XL-7 2.7L



## 5210

Inlet A: WELDED 2-BOLT FLANGE  
 Inlet B: WELDED 2-BOLT FLANGE  
 Outlet A: WELDED 2-BOLT FLANGE W/GASKET STUB  
 Length: 22.50"



2006-04 6 MITSUBISHI MONTERO 3.8L

## 5211

Inlet A: WELDED 2-BOLT FLANGE  
 Outlet A: WELDED 2-BOLT FLANGE W/FLARE  
 Length: 17.50"



2006-03 6 MITSUBISHI MONTERO 3.8L

## 5212

Inlet A: WELDED 4-BOLT FLANGE  
 Inlet B: WELDED 4-BOLT FLANGE  
 Outlet A: WELDED 4-BOLT FLANGE  
 Length: 36"

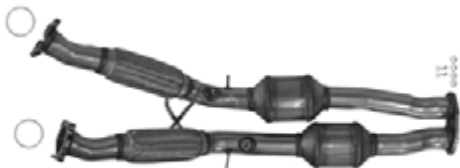

2010-07 6 VOLVO XC90 3.2L

## 5214

Inlet A: WELDED 3-BOLT FLANGE  
 Inlet B: WELDED 3-BOLT FLANGE  
 Outlet A: WELDED 3-BOLT FLANGE  
 Length: 44.07"



2014-13 6 HONDA ACCORD 3.5L

## 5215

Inlet A: 3.11" FLARE  
 Outlet A: 2.05" O.D. PIPE  
 Length: 43.50"



2009-07 4 MINI COOPER 1.6L

## 5216

Inlet A: WELDED 3-BOLT FLANGE  
 Outlet A: WELDED 3-BOLT FLANGE  
 Length: 42"



2002-01 4 SATURN L100 2.2L  
 2003-01 4 SATURN L200 2.2L  
 2003-01 4 SATURN LW200 2.2L

## 5217

Inlet A: WELDED 3-BOLT FLANGE  
 Outlet A: WELDED 3-BOLT FLANGE  
 Length: 41"



2010-08 4 SATURN VUE 2.4L

# DIRECT FIT

## 5218

Inlet A: WELDED 3-BOLT FLANGE  
 Inlet B: WELDED 2-BOLT FLANGE  
 Outlet A: WELDED 2-BOLT FLANGE  
 Length: 28.25"



- 2007-06 6 CHEVROLET MALIBU 3.9L
- 2008-07 6 CHEVROLET MALIBU 3.5L
- 2007-06 6 PONTIAC G6 3.9L
- 2007 6 PONTIAC G6 3.5L
- 2007 6 SATURN AURA 3.5L

## 5219

Inlet A: WELDED 3-BOLT FLANGE  
 Outlet A: WELDED 2-BOLT FLANGE  
 Length: 18.25"



- 2012-08 4 CHEVROLET MALIBU 2.4L
- 2010-09 4 PONTIAC G6 2.4L

## 5220

Inlet A: WELDED 2-BOLT FLANGE  
 Outlet A: WELDED 2-BOLT FLANGE  
 Length: 22.81"



- 2008-06 6 BUICK LUCERNE 3.8L

## 5221

Inlet A: WELDED 3-BOLT FLANGE  
 Outlet A: WELDED 2-BOLT FLANGE  
 Length: 25.75"



- 2015-10 4 CHEVROLET EQUINOX 2.4L

## 5221 (cont.)

- 2015-10 4 GMC TERRAIN 2.4L

## 5222

Inlet A: WELDED 2-BOLT FLANGE  
 Outlet A: WELDED 2-BOLT FLANGE  
 Length: 26"



- 2011-09 6 BUICK LUCERNE 3.9L

## 5223

Inlet A: WELDED 2-BOLT FLANGE  
 Outlet A: WELDED 2-BOLT FLANGE  
 Length: 38.50"



- 2011-10 6 CHEVROLET IMPALA FWD 3.9L

## 5224

Inlet A: WELDED 2-BOLT FLANGE  
 Outlet A: 2.48" O.D. PIPE  
 Length: 34"



- 2011-10 6 CHEVROLET CAMARO 3.6L

## 5225

Inlet A: WELDED 2-BOLT FLANGE  
 Outlet A: 2.48" O.D. PIPE  
 Length: 34"



- 2011-10 6 CHEVROLET CAMARO 3.6L

### 9002

Inlet A: 2.50" I.D. PIPE  
 Outlet A: 2.50" O.D. PIPE  
 Length: 24.75"



1980-75	8	CHEVROLET MARATHON All
1991-86	6	CHEVROLET ASTRO VAN 4.3L
1978-75	8	CHEVROLET BLAZER FULL SIZE 6.6L
1987-83	8	CHEVROLET BLAZER FULL SIZE All
1986-83	6	CHEVROLET C-(2WD), K-(4WD) PICKUP 1/2 TON, (Inc. SILVERADO & AVALANCHE) All
1986-83	8	CHEVROLET C-(2WD), K-(4WD) PICKUP 1/2 TON, (Inc. SILVERADO & AVALANCHE) 5.7L
1979-75	8	CHEVROLET C-(2WD), K-(4WD) PICKUP 1/2 TON, (Inc. SILVERADO & AVALANCHE) 7.4L
1984-75	6	CHEVROLET C-(2WD), K-(4WD) PICKUP 3/4 TON, (Inc. SILVERADO & AVALANCHE) 4.1L
1986-85	6	CHEVROLET C-(2WD), K-(4WD) PICKUP 3/4 TON, (Inc. SILVERADO & AVALANCHE) 4.3L
1986-83	8	CHEVROLET C-(2WD), K-(4WD) PICKUP 3/4 TON, (Inc. SILVERADO & AVALANCHE) 5.0L
1986-83	8	CHEVROLET C-(2WD), K-(4WD) PICKUP 3/4 TON, (Inc. SILVERADO & AVALANCHE) 5.7L
1982-75	8	CHEVROLET C-(2WD), K-(4WD) PICKUP 3/4 TON, (Inc. SILVERADO & AVALANCHE) All
1979-78	8	CHEVROLET G -VAN 1 TON (Inc. Express Van) All
1986-80	8	CHEVROLET G -VAN 1 TON (Inc. Express Van) 5.7L
1990-78	6	CHEVROLET G -VAN 1 TON (Inc. Express Van) All
1994-91	6	CHEVROLET G -VAN 1 TON (Inc. Express Van) 4.3L
1982-75	6	CHEVROLET G -VAN 1/2 & 3/4 TON (Inc. Express Van) 4.1L
1994-85	6	CHEVROLET G -VAN 1/2 & 3/4 TON (Inc. Express Van) 4.3L
1994-87	8	CHEVROLET G -VAN 1/2 & 3/4 TON (Inc. Express Van) 5.0L
1980-79	8	CHEVROLET G -VAN 1/2 & 3/4 TON (Inc. Express Van) 6.6L
1986-83	8	CHEVROLET G -VAN 1/2 & 3/4 TON (Inc. Express Van) All
1987	6	CHEVROLET R-(2WD), V-(4WD) PICKUP 4.3L
1982-75	8	CHEVROLET SUBURBAN/TAHOE All
1986-83	8	CHEVROLET SUBURBAN/TAHOE 5.7L
1987-83	8	CHEVROLET SUBURBAN/TAHOE 5.0L
1986-83	6	GMC C-(2WD), K-(4WD) PICKUP 1/2 TON, (Inc. SIERRA) All
1986-83	8	GMC C-(2WD), K-(4WD) PICKUP 1/2 TON, (Inc. SIERRA) 5.7L
1979-75	8	GMC C-(2WD), K-(4WD) PICKUP 1/2 TON, (Inc. SIERRA) 7.4L
1984-75	6	GMC C-(2WD), K-(4WD) PICKUP 3/4 TON, (Inc. SIERRA) 4.1L
1986-85	6	GMC C-(2WD), K-(4WD) PICKUP 3/4 TON, (Inc. SIERRA) 4.3L

### 9002 (cont.)

1986-83	8	GMC C-(2WD), K-(4WD) PICKUP 3/4 TON, (Inc. SIERRA) 5.0L
1986-83	8	GMC C-(2WD), K-(4WD) PICKUP 3/4 TON, (Inc. SIERRA) 5.7L
1982-75	8	GMC C-(2WD), K-(4WD) PICKUP 3/4 TON, (Inc. SIERRA) All
1979-78	8	GMC G -VAN 1 TON (Inc. Savana Van) All
1986-80	8	GMC G -VAN 1 TON (Inc. Savana Van) 5.7L
1990-78	6	GMC G -VAN 1 TON (Inc. Savana Van) All
1994-91	6	GMC G -VAN 1 TON (Inc. Savana Van) 4.3L
1980-79	8	GMC G -VAN 1/2 & 3/4 TON (Inc. Savana Van) 6.6L
1982-75	6	GMC G -VAN 1/2 & 3/4 TON (Inc. Savana Van) 4.1L
1986-83	8	GMC G -VAN 1/2 & 3/4 TON (Inc. Savana Van) All
1994-85	6	GMC G -VAN 1/2 & 3/4 TON (Inc. Savana Van) 4.3L
1994-87	8	GMC G -VAN 1/2 & 3/4 TON (Inc. Savana Van) 5.0L
1978-75	8	GMC JIMMY FULL SIZE 6.6L
1987-83	8	GMC JIMMY FULL SIZE All
1991-86	6	GMC SAFARI VAN 4.3L
1982-75	8	GMC SUBURBAN/YUKON All
1986-83	8	GMC SUBURBAN/YUKON 5.7L
1987-83	8	GMC SUBURBAN/YUKON 5.0L

### 9008

Inlet A: WELDED 2-BOLT FLANGE  
 Outlet A: 2" O.D. PIPE  
 Length: 30.50"



2004-01	6	FORD ESCAPE 3.0L
2004-01	6	MAZDA TRIBUTE 3.0L

### 9009

Inlet A: LOOSE 2-BOLT FLANGE W/ FEMALE FLARE  
 Inlet B: LOOSE 2-BOLT FLANGE W/ FEMALE FLARE  
 Outlet A: LOOSE 2-BOLT FLANGE W/ FLAT FLARE  
 Length: 52"

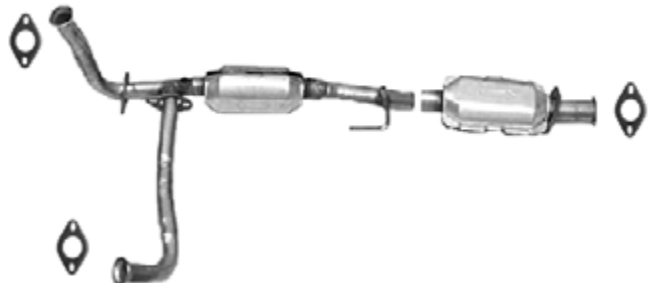

1993-86	6	FORD AEROSTAR 3.0L
---------	---	--------------------

# DIRECT FIT

## 9014

Inlet A: WELDED 3-BOLT FLANGE  
 Outlet A: LOOSE 2-BOLT FLANGE W/ MALE BALL  
 Length: 23.50"



2003-00 6 JEEP WRANGLER 4.0L

## 9015

Inlet A: 2.50" I.D. PIPE  
 Outlet A: 2.50" O.D. PIPE  
 Length: 71"



1999-97 6 DODGE DAKOTA 3.9L  
 1999-97 8 DODGE DAKOTA 5.2L

## 9018

Inlet A: LOOSE 2-BOLT FLANGE W/ FEMALE FLARE  
 Inlet B: LOOSE 2-BOLT FLANGE W/ FEMALE FLARE  
 Outlet A: 2.50" O.D. PIPE  
 Length: 48.75"

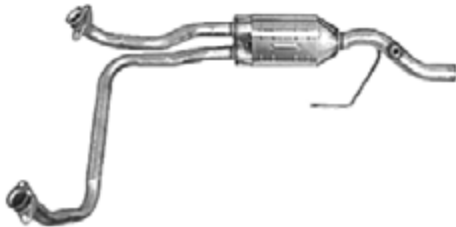

2003-98 6 DODGE B-VAN 3.9L  
 2003-98 8 DODGE B-VAN 5.2L  
 2003-98 8 DODGE B-VAN 5.9L

## 9019

Inlet A: LOOSE 3-BOLT FLANGE W/ SPHERICAL FLARE  
 Inlet B: LOOSE 3-BOLT FLANGE W/ SPHERICAL FLARE  
 Outlet A: WELDED 2-BOLT FLANGE  
 Length: 69.75"

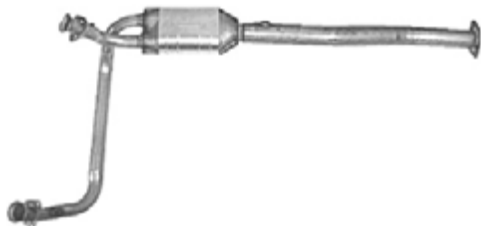

2002-00 6 CHEVROLET G -VAN 1/2 & 3/4 TON (Inc. Express Van) 4.3L  
 2002-00 8 CHEVROLET G -VAN 1/2 & 3/4 TON (Inc.

## 9019 (cont.)

Express Van) 5.0L  
 2002-00 6 GMC G -VAN 1/2 & 3/4 TON (Inc. Savana Van) 4.3L  
 2002-00 8 GMC G -VAN 1/2 & 3/4 TON (Inc. Savana Van) 5.0L

## 9020

Inlet A: 2.50" I.D. PIPE  
 Outlet A: 2.50" O.D. PIPE  
 Length: 53"



1991-88 8 DODGE D-(2WD) & W-(4WD) PICKUP 1 TON 5.9L  
 1992-88 6 DODGE D-(2WD) & W-(4WD) PICKUP 1/2 & 3/4 TON 3.9L  
 1992-88 8 DODGE D-(2WD) & W-(4WD) PICKUP 1/2 & 3/4 TON 5.9L

## 9023

Inlet A: WELDED 4-BOLT FLANGE  
 Outlet A: WELDED 2-BOLT FLANGE  
 Length: 34"

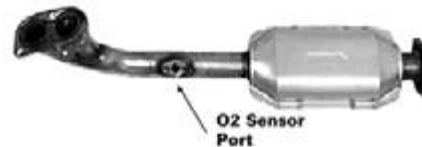

2000-96 6 TOYOTA 4 RUNNER 3.4L

## 9026

Inlet A: LOOSE 2-BOLT FLANGE W/ FEMALE FLARE  
 Inlet B: LOOSE 2-BOLT FLANGE W/ FEMALE FLARE  
 Outlet A: WELDED 2-BOLT FLANGE  
 Length: 53.75"

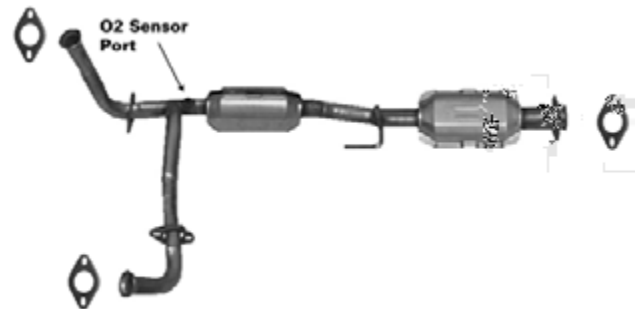

1997-90 6 FORD AEROSTAR 4.0L

### 9027

Inlet A: WELDED 4-BOLT FLANGE  
 Outlet A: 2.085" O.D. PIPE  
 Length: 60"



2003-98 8 CADILLAC SEVILLE 4.6L

### 9028

Inlet A: LOOSE 3-BOLT FLANGE W/ FEMALE FLARE  
 Inlet B: LOOSE 3-BOLT FLANGE W/ FEMALE FLARE  
 Outlet A: 3" O.D. PIPE  
 Length: 50.25"

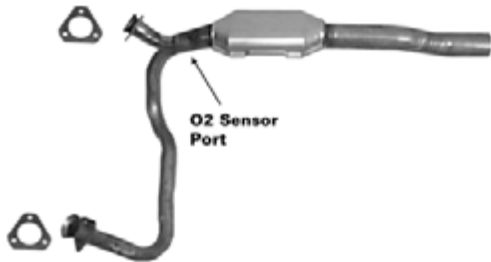

1995-94 6 CHEVROLET ASTRO VAN 4.3L  
 1995-94 6 GMC SAFARI VAN 4.3L

### 9029

Inlet A: WELDED 2-BOLT FLANGE  
 Inlet B: WELDED 2-BOLT FLANGE  
 Outlet A: WELDED 3-BOLT FLANGE  
 Length: 21.25"



1998-96 8 FORD EXPLORER 5.0L  
 1998-97 8 MERCURY MOUNTAINEER 5.0L

### 9030

Inlet A: WELDED 3-BOLT FLANGE W/ STUDS  
 Outlet A: WELDED 2-BOLT FLANGE  
 Length: 24.75"

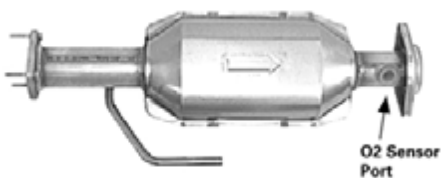

2002-01 4 JEEP WRANGLER 2.5L  
 2003-00 6 JEEP WRANGLER 4.0L

### 9032

Inlet A: 3-BOLT FLANGE W/ 45 DEGREE FLARE  
 Inlet B: 3-BOLT FLANGE W/ 45 DEGREE FLARE  
 Outlet A: WELDED 2-BOLT FLANGE  
 Outlet B: WELDED 2-BOLT FLANGE  
 Length: 79.50"



1999-97 8 CHEVROLET CORVETTE 5.7L

### 9033

Inlet A: WELDED 3-BOLT FLANGE  
 Inlet B: 2-BOLT FLANGE W/ FEMALE FLARE  
 Outlet A: 2.75" O.D. PIPE  
 Length: 51.50"



1999-98 8 CHEVROLET CAMARO 5.7L  
 1999-98 8 PONTIAC FIREBIRD, TRANS AM, FORMULA 5.7L

### 9034

Inlet A: WELDED 3-BOLT FLANGE  
 Outlet A: LOOSE 2-BOLT FLANGE W/ 2.25" MALE BALL  
 Length: 18"



1999-98 8 CHEVROLET CAMARO 5.7L  
 1999-98 8 PONTIAC FIREBIRD, TRANS AM, FORMULA 5.7L

### 9035

Inlet A: WELDED 4-BOLT FLANGE  
 Outlet A: 2.125" O.D. PIPE  
 Length: 64.75"



2005-00 6 BUICK LESABRE 3.8L

**9035 (cont.)**

2005-00	6	BUICK PARK AVENUE 3.8L
2005-00	8	CADILLAC DEVILLE 4.6L
2011-06	8	CADILLAC DTS 4.6L
2002-01	6	OLDSMOBILE AURORA 3.5L
2003-01	8	OLDSMOBILE AURORA 4.0L
2005-00	6	PONTIAC BONNEVILLE 3.8L
2005-04	8	PONTIAC BONNEVILLE 4.6L

**9036**

**Inlet A: LOOSE 2-BOLT FLANGE W/ FEMALE FLARE**  
**Outlet A: 2.50" O.D. PIPE**  
**Length: 38"**



1992	8	CADILLAC COMMERCIAL CHASSIS - FUNERAL COACH, LIMOUSINE 4.9L
1990-88	8	CADILLAC DEVILLE 4.5L
1992	8	CADILLAC FLEETWOOD 4.9L
1993-92	6	PONTIAC BONNEVILLE 3.8L

**9041**

**Inlet A: LOOSE 3-BOLT FLANGE W/ 45 DEGREE FLARE**  
**Outlet A: WELDED 2-BOLT FLANGE**  
**Length: 35.75"**



1999	4	SAAB 9-5 2.3L
------	---	---------------

**9042**

**Inlet A: 3-BOLT FLANGE W/ FEMALE FLARE**  
**Outlet A: 3" O.D. PIPE**  
**Length: 60.75"**



1996	8	CHEVROLET G -VAN 1 TON (Inc. Express Van) 5.7L
1999-96	8	CHEVROLET G -VAN 1/2 & 3/4 TON (Inc. Express Van) 5.7L
1996	8	GMC G -VAN 1 TON (Inc. Savana Van) 5.7L
1999-96	8	GMC G -VAN 1/2 & 3/4 TON (Inc. Savana Van) 5.7L

**9043**

**Inlet A: 3-BOLT FLANGE W/ FEMALE FLARE**  
**Outlet A: WELDED 3-BOLT FLANGE**  
**Length: 66.25"**



1996	8	CHEVROLET G -VAN 1 TON (Inc. Express Van) 5.7L
1999-96	8	CHEVROLET G -VAN 1/2 & 3/4 TON (Inc. Express Van) 5.7L
1996	8	GMC G -VAN 1 TON (Inc. Savana Van) 5.7L
1999-96	8	GMC G -VAN 1/2 & 3/4 TON (Inc. Savana Van) 5.7L

**9047**

**Inlet A: LOOSE 3-BOLT FLANGE W/ 45 DEGREE FLARE**  
**Outlet A: FEMALE FLARE**  
**Length: 31.25"**



2002-99	4	SAAB 9-3 All
1998-96	4	SAAB 900 2.0L

**9050**

**Inlet A: LOOSE 2-BOLT FLANGE W/ FEMALE FLARE**  
**Inlet B: 2.50" I.D. PIPE**  
**Outlet A: 2.50" O.D. PIPE**  
**Length: 47.38"**



2000-97	8	FORD EXPEDITION 5.4L
2000-98	8	FORD F-150 PICKUP 1/2 TON 5.4L
1999-98	8	FORD F-250 PICKUP 3/4 TON 5.4L
2000-98	8	LINCOLN NAVIGATOR 5.4L

### 9051

Inlet A: LOOSE 2-BOLT FLANGE W/ FEMALE FLARE  
 Outlet A: 2.50" O.D. PIPE  
 Length: 46"



2000-97 8 FORD EXPEDITION 5.4L  
 2000-98 8 FORD F-150 PICKUP 1/2 TON 5.4L  
 1999-98 8 FORD F-250 PICKUP 3/4 TON 5.4L  
 2000-98 8 LINCOLN NAVIGATOR 5.4L

### 9054

Inlet A: LOOSE 2-BOLT FLANGE W/ SPHERICAL FLARE  
 Inlet B: LOOSE 2-BOLT FLANGE W/ SPHERICAL FLARE  
 Outlet A: 2.50" O.D. PIPE  
 Length: 60"

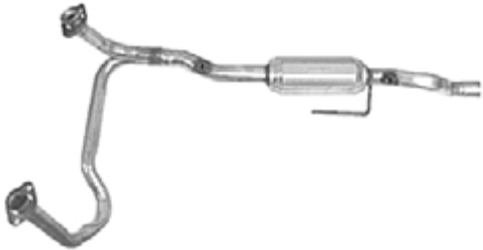

2003-00 6 DODGE DAKOTA 3.9L

### 9055

Inlet A: 2.50" I.D. PIPE  
 Outlet A: 2.50" O.D. PIPE  
 Length: 59.50"



1999-97 8 DODGE DAKOTA 5.2L  
 1999-98 8 DODGE DAKOTA 5.9L

### 9056

Inlet A: LOOSE 2-BOLT FLANGE W/ SPHERICAL FLARE  
 Inlet B: 2.50" I.D. PIPE  
 Outlet A: 2.50" O.D. PIPE  
 Length: 45.25"



2000-97 8 FORD F-150 PICKUP 1/2 TON 4.6L  
 1998-97 8 FORD F-250 PICKUP 3/4 TON 4.6L

### 9057

Inlet A: LOOSE 2-BOLT FLANGE W/ SPHERICAL FLARE  
 Outlet A: 2.50" O.D. PIPE  
 Length: 35"



2000-97 8 FORD F-150 PICKUP 1/2 TON 4.6L  
 1998-97 8 FORD F-250 PICKUP 3/4 TON 4.6L

### 9058

Inlet A: WELDED 3-BOLT FLANGE W/ GASKET STUB  
 Outlet A: WELDED 2-BOLT FLANGE W/ GASKET STUB  
 Length: 27"



2002-00 8 TOYOTA TUNDRA 4.7L

### 9059

Inlet A: WELDED 3-BOLT FLANGE W/ GASKET STUB  
 Outlet A: WELDED 2-BOLT FLANGE W/ GASKET STUB  
 Length: 49.75"



2002-00 8 TOYOTA TUNDRA 4.7L

# DIRECT FIT

## 9060

Inlet A: WELDED 3-BOLT FLANGE  
 Outlet A: WELDED 2-BOLT FLANGE W/ GASKET STUB  
 Length: 33"



1998-95 6 FORD EXPLORER 4.0L

## 9062

Inlet A: LOOSE 2-BOLT FLANGE W/ SPHERICAL FLARE  
 Inlet B: WELDED 3-BOLT FLANGE  
 Outlet A: 2.71" O.D. PIPE  
 Length: 53"



1997-95 8 CHEVROLET CAMARO 5.7L  
 1997-95 8 PONTIAC FIREBIRD, TRANS AM, FORMULA 5.7L

## 9063

Inlet A: LOOSE 3-BOLT FLANGE W/ FEMALE FLARE  
 Inlet B: WELDED 3-BOLT FLANGE  
 Outlet A: WELDED 2-BOLT FLANGE  
 Length: 50.50"

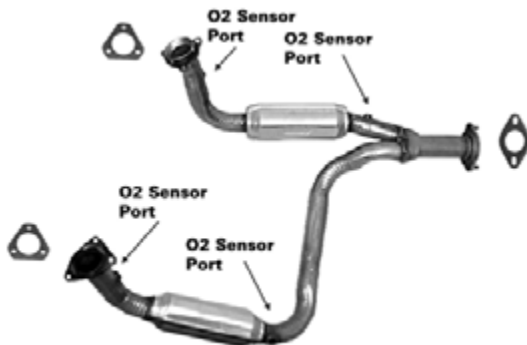

2000-99 6 CHEVROLET C-(2WD), K-(4WD) PICKUP 1/2 TON, (Inc. SILVERADO & AVALANCHE) 4.3L  
 2000-99 8 CHEVROLET C-(2WD), K-(4WD) PICKUP 1/2 TON, (Inc. SILVERADO & AVALANCHE) 4.8L  
 2000-99 8 CHEVROLET C-(2WD), K-(4WD) PICKUP 1/2 TON, (Inc. SILVERADO & AVALANCHE) 5.3L  
 2000-99 8 CHEVROLET C-(2WD), K-(4WD) PICKUP 3/4 TON, (Inc. SILVERADO & AVALANCHE) 5.3L  
 2000-98 6 GMC C-(2WD), K-(4WD) PICKUP 1/2 TON, (Inc.

## 9063 (cont.)

SIERRA) 4.3L  
 2000-99 8 GMC C-(2WD), K-(4WD) PICKUP 1/2 TON, (Inc. SIERRA) 4.8L  
 2000-99 8 GMC C-(2WD), K-(4WD) PICKUP 1/2 TON, (Inc. SIERRA) 5.3L  
 2000-99 8 GMC C-(2WD), K-(4WD) PICKUP 3/4 TON, (Inc. SIERRA) 5.3L

## 9067

Inlet A: WELDED 2-BOLT FLANGE  
 Outlet A: WELDED 2-BOLT FLANGE  
 Length: 17.63"



2000-95 4 TOYOTA TACOMA 2.7L  
 2000-95 6 TOYOTA TACOMA 3.4L

## 9068

Inlet A: WELDED 4-BOLT FLANGE  
 Outlet A: LOOSE 2-BOLT FLANGE W/ SPECIAL RING  
 Length: 56"



1994-91 4 BMW 318 1.8L

## 9069

Inlet A: LOOSE 3-BOLT FLANGE W/ FEMALE FLARE  
 Inlet B: LOOSE 3-BOLT FLANGE W/ FEMALE FLARE  
 Outlet A: LOOSE 4-BOLT FLANGE W/ MALE BALL  
 Length: 46.75"

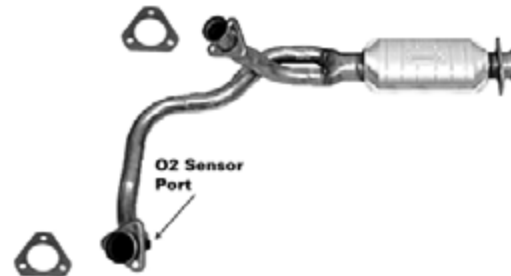

1995-93 8 CHEVROLET CAMARO 5.7L  
 1995-93 8 PONTIAC FIREBIRD, TRANS AM, FORMULA 5.7L



### 9075

Inlet A: LOOSE 3-BOLT FLANGE W/ 45 DEGREE FLARE  
 Inlet B: LOOSE 3-BOLT FLANGE W/ 45 DEGREE FLARE  
 Outlet A: WELDED 3-BOLT FLANGE  
 Length: 54.75"

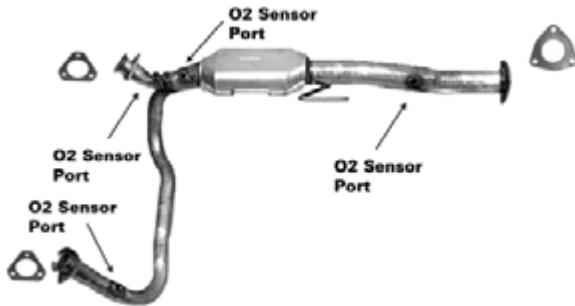

1999-96 6 CHEVROLET ASTRO VAN 4.3L  
 1999-96 6 GMC SAFARI VAN 4.3L

### 9078

Inlet A: LOOSE 2-BOLT FLANGE W/ SPHERICAL FLARE  
 Inlet B: 2.50" I.D. PIPE  
 Outlet A: 2.50" O.D. PIPE  
 Length: 46.75"



2003-97 6 FORD F-150 PICKUP 1/2 TON 4.2L

### 9079

Inlet A: LOOSE 2-BOLT FLANGE W/ SPHERICAL FLARE  
 Outlet A: 2.50" O.D. PIPE  
 Length: 36"



2003-97 6 FORD F-150 PICKUP 1/2 TON 4.2L

### 9080

Inlet A: LOOSE 3-BOLT FLANGE W/ FLARE  
 Outlet A: 3" O.D. PIPE  
 Length: 61.75"



2000-96 8 CHEVROLET G -VAN 1 TON (Inc. Express Van) 5.7L  
 2000-97 8 CHEVROLET G -VAN 1/2 & 3/4 TON (Inc. Express Van) 5.7L  
 2000-96 8 GMC G -VAN 1 TON (Inc. Savana Van) 5.7L  
 2000-97 8 GMC G -VAN 1/2 & 3/4 TON (Inc. Savana Van) 5.7L

### 9081

Inlet A: LOOSE 3-BOLT FLANGE W/ FLARE  
 Outlet A: WELDED 3-BOLT FLANGE  
 Length: 66.50"



2000-96 8 CHEVROLET G -VAN 1 TON (Inc. Express Van) 5.7L  
 2000-97 8 CHEVROLET G -VAN 1/2 & 3/4 TON (Inc. Express Van) 5.7L  
 2000-96 8 GMC G -VAN 1 TON (Inc. Savana Van) 5.7L  
 2000-97 8 GMC G -VAN 1/2 & 3/4 TON (Inc. Savana Van) 5.7L

### 9082

Inlet A: LOOSE 2-BOLT FLANGE W/ SPHERICAL FLARE  
 Inlet B: LOOSE 2-BOLT FLANGE W/ SPHERICAL FLARE  
 Outlet A: 2.25" O.D. PIPE  
 Length: 70.75"



1996 6 FORD F-150 PICKUP 1/2 TON 4.9L  
 1996 6 FORD F-250 PICKUP 3/4 TON 4.9L  
 1996 6 FORD F-350 PICKUP 1 TON 4.9L

# DIRECT FIT

## 9083

Inlet A: LOOSE 3-BOLT FLANGE W/ SPHERICAL FLARE  
 Inlet B: WELDED 3-BOLT FLANGE  
 Outlet A: WELDED 2-BOLT FLANGE  
 Length: 50.50"



- 2005-02 8 CADILLAC ESCALADE 5.3L
- 2006-00 6 CHEVROLET C-(2WD), K-(4WD) PICKUP 1/2 TON, (Inc. SILVERADO & AVALANCHE) 4.3L
- 2006-00 8 CHEVROLET C-(2WD), K-(4WD) PICKUP 1/2 TON, (Inc. SILVERADO & AVALANCHE) 4.8L
- 2006-00 8 CHEVROLET C-(2WD), K-(4WD) PICKUP 1/2 TON, (Inc. SILVERADO & AVALANCHE) 5.3L
- 2000 8 CHEVROLET C-(2WD), K-(4WD) PICKUP 3/4 TON, (Inc. SILVERADO & AVALANCHE) 5.3L
- 2005-00 8 CHEVROLET SUBURBAN/TAHOE 4.8L
- 2005-00 8 CHEVROLET SUBURBAN/TAHOE 5.3L
- 2006-00 6 GMC C-(2WD), K-(4WD) PICKUP 1/2 TON, (Inc. SIERRA) 4.3L
- 2006-00 8 GMC C-(2WD), K-(4WD) PICKUP 1/2 TON, (Inc. SIERRA) 4.8L
- 2006-00 8 GMC C-(2WD), K-(4WD) PICKUP 1/2 TON, (Inc. SIERRA) 5.3L
- 2000 8 GMC C-(2WD), K-(4WD) PICKUP 3/4 TON, (Inc. SIERRA) 5.3L
- 2005-01 8 GMC SUBURBAN/YUKON 4.8L
- 2005-01 8 GMC SUBURBAN/YUKON 5.3L

## 9084

Inlet A: LOOSE 2-BOLT FLANGE W/ SPHERICAL FLARE  
 Inlet B: 2.50" I.D. PIPE  
 Outlet A: 2.50" O.D. PIPE  
 Length: 49.50"



- 2004-01 8 FORD F-150 PICKUP 1/2 TON 5.4L

## 9085

Inlet A: LOOSE 2-BOLT FLANGE W/ SPHERICAL FLARE  
 Outlet A: 2.50" O.D. PIPE  
 Length: 35.50"



- 2004-01 8 FORD F-150 PICKUP 1/2 TON 5.4L

## 9086

Inlet A: LOOSE 2-BOLT FLANGE W/ FEMALE FLARE  
 Outlet A: WELDED 2-BOLT FLANGE W/ GASKET STUB  
 Length: 49"



- 2001-98 4 FORD RANGER 2.5L
- 2001-98 4 MAZDA B-Series PICKUP 2.5L

## 9088

Inlet A: LOOSE 2-BOLT FLANGE W/ FEMALE FLARE  
 Inlet B: LOOSE 2-BOLT FLANGE W/ FEMALE FLARE  
 Outlet A: 2.50" O.D. PIPE  
 Length: 54.50"

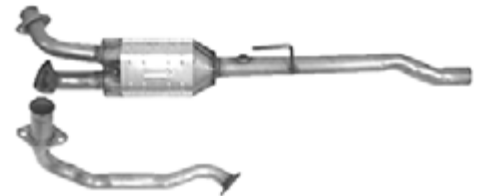

- 2003-02 6 DODGE RAM (2WD & 4WD) PICKUP 1/2 & 3/4 TON 3.7L
- 2003-02 8 DODGE RAM (2WD & 4WD) PICKUP 1/2 & 3/4 TON 4.7L
- 2003-02 8 DODGE RAM (2WD & 4WD) PICKUP 1/2 & 3/4 TON 5.9L

### 9091

Inlet A: LOOSE 3-BOLT FLANGE W/ SPHERICAL FLARE  
 Inlet B: LOOSE 3-BOLT FLANGE W/ SPHERICAL FLARE  
 Outlet A: WELDED 2-BOLT FLANGE  
 Length: 52"

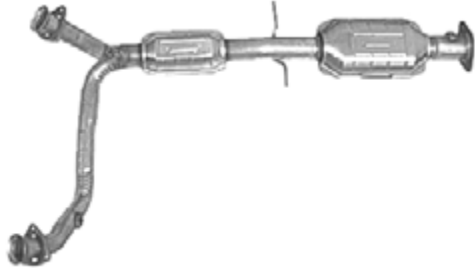

- 2002-00 6 CHEVROLET S-Series (2WD), T-Series (4WD) PICKUP 4.3L
- 2002-00 6 GMC S-Series (2WD), T-Series (4WD) PICKUP (SONOMA) 4.3L

### 9092

Inlet A: LOOSE 3-BOLT FLANGE W/ FLARE  
 Inlet B: LOOSE 3-BOLT FLANGE W/ FLARE  
 Outlet A: WELDED 3-BOLT FLANGE  
 Length: 50.88"



- 2000-96 8 CHEVROLET C-(2WD), K-(4WD) PICKUP 1 TON, (Inc. SILVERADO) 5.7L
- 2000-96 8 CHEVROLET C-(2WD), K-(4WD) PICKUP 3/4 TON, (Inc. SILVERADO & AVALANCHE) 5.7L
- 1999-96 8 CHEVROLET SUBURBAN/TAHOE 5.7L
- 2000-96 8 GMC C-(2WD), K-(4WD) PICKUP 1 TON, (Inc. SIERRA) 5.7L
- 2000-96 8 GMC C-(2WD), K-(4WD) PICKUP 3/4 TON, (Inc. SIERRA) 5.7L
- 1999-96 8 GMC SUBURBAN/YUKON 5.7L

### 9093

Inlet A: WELDED 3-BOLT FLANGE  
 Outlet A: 2.550" O.D. PIPE  
 Outlet B: 2.550" O.D. PIPE  
 Length: 37.50"



- 1999-96 8 CHEVROLET C-(2WD), K-(4WD) PICKUP 1 TON, (Inc. SILVERADO) 5.7L
- 1999-96 8 CHEVROLET C-(2WD), K-(4WD) PICKUP 3/4 TON, (Inc. SILVERADO & AVALANCHE) 5.7L
- 1999-96 8 GMC C-(2WD), K-(4WD) PICKUP 1 TON, (Inc. SIERRA) 5.7L

### 9093 (cont.)

1999-96 8 GMC C-(2WD), K-(4WD) PICKUP 3/4 TON, (Inc. SIERRA) 5.7L

### 9094

Inlet A: WELDED 2-BOLT FLANGE W/ GASKET STUB  
 Inlet B: WELDED 2-BOLT FLANGE W/ GASKET STUB  
 Outlet A: WELDED 2-BOLT FLANGE W/ GASKET STUB  
 Length: 37"



- 2003-01 6 TOYOTA SIENNA 3.0L

### 9095

Inlet A: WELDED 2-BOLT FLANGE W/ SPHERICAL FLARE  
 Outlet A: WELDED 2-BOLT FLANGE  
 Length: 35.50"



- 2003-01 6 TOYOTA SIENNA 3.0L

### 9096

Inlet A: LOOSE 2-BOLT FLANGE W/ SPHERICAL FLARE  
 Inlet B: 2.50" I.D. PIPE  
 Outlet A: 2.50" O.D. PIPE  
 Length: 47"



- 2000-99 8 FORD EXPEDITION 4.6L
- 2000-97 8 FORD F-150 PICKUP 1/2 TON 4.6L

# DIRECT FIT

## 9097

Inlet A: LOOSE 2-BOLT FLANGE W/ SPHERICAL FLARE  
Outlet A: 2.50" O.D. PIPE  
Length: 34"



2000-99 8 FORD EXPEDITION 4.6L  
2000-97 8 FORD F-150 PICKUP 1/2 TON 4.6L

## 9098

Inlet A: WELDED 3-BOLT FLANGE  
Outlet A: 2.165" O.D. PIPE  
Length: 43.50"



2000-97 6 VOLKSWAGEN EUROVAN 2.8L

## 9099

Inlet A: LOOSE 2-BOLT FLANGE W/ SPHERICAL FLARE  
Outlet A: 2.25" O.D. PIPE  
Length: 47.25"



1998-97 4 JEEP WRANGLER 2.5L

## 9100

Inlet A: LOOSE 2-BOLT FLANGE W/ SPHERICAL FLARE  
Outlet A: 2.25" O.D. PIPE  
Length: 52"



2000-97 6 JEEP WRANGLER 4.0L

## 9102

Inlet A: LOOSE 2-BOLT FLANGE W/ SPHERICAL FLARE  
Outlet A: 2.25" O.D. PIPE  
Length: 52"



2000-97 6 JEEP WRANGLER 4.0L

## 9105

Inlet A: LOOSE 2-BOLT FLANGE W/ SPHERICAL FLARE  
Outlet A: 2.25" O.D. PIPE  
Length: 47.75"

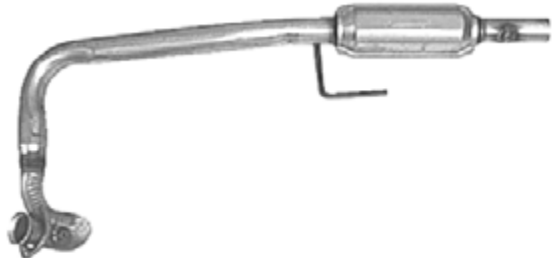

2000-99 4 JEEP WRANGLER 2.5L

## 9106

Inlet A: WELDED 3-BOLT FLANGE  
Outlet A: LOOSE 2-BOLT FLANGE W/ MALE BALL  
Length: 25.38"



2002-00 8 CHEVROLET CAMARO 5.7L  
2002-00 8 PONTIAC FIREBIRD, TRANS AM, FORMULA 5.7L

## 9107

Inlet A: WELDED 3-BOLT FLANGE  
Outlet A: LOOSE 2-BOLT FLANGE W/ MALE BALL  
Length: 18"



2002-00 8 CHEVROLET CAMARO 5.7L

### 9107 (cont.)

2002-00 8 PONTIAC FIREBIRD, TRANS AM, FORMULA 5.7L

### 9108

Inlet A: LOOSE 3-BOLT FLANGE W/ SPHERICAL FLARE  
 Inlet B: LOOSE 3-BOLT FLANGE W/ SPHERICAL FLARE  
 Outlet A: WELDED 2-BOLT FLANGE  
 Length: 59.25"



2000 6 CHEVROLET BLAZER S-Series 4.3L  
 2000 6 GMC ENVOY 4.3L  
 2000 6 GMC S-15 JIMMY 4.3L  
 2000 6 OLDSMOBILE BRAVADA 4.3L

### 9109

Inlet A: LOOSE 3-BOLT FLANGE W/ SPHERICAL FLARE  
 Inlet B: LOOSE 3-BOLT FLANGE W/ SPHERICAL FLARE  
 Outlet A: WELDED 2-BOLT FLANGE  
 Length: 59.25"

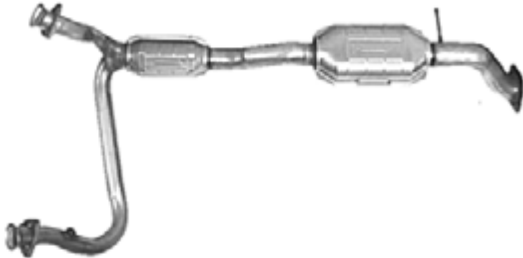

2005-00 6 CHEVROLET BLAZER S-Series 4.3L  
 2004-01 6 CHEVROLET S-Series (2WD), T-Series (4WD) PICKUP 4.3L  
 2002-00 6 GMC S-15 JIMMY 4.3L  
 2004-01 6 GMC S-Series (2WD), T-Series (4WD) PICKUP (SONOMA) 4.3L  
 2001-00 6 OLDSMOBILE BRAVADA 4.3L

### 9110

Inlet A: LOOSE 3-BOLT FLANGE W/ SPHERICAL FLARE  
 Inlet B: LOOSE 3-BOLT FLANGE W/ SPHERICAL FLARE  
 Outlet A: WELDED 2-BOLT FLANGE  
 Length: 61.50"

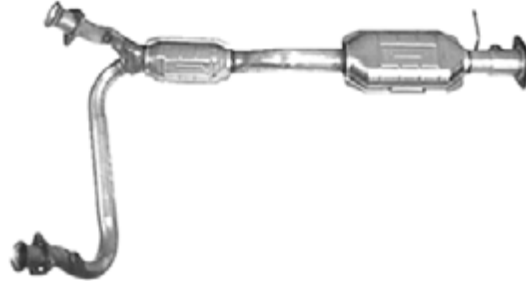

2003-01 6 CHEVROLET S-Series (2WD), T-Series (4WD) PICKUP 4.3L  
 2003-01 6 GMC S-Series (2WD), T-Series (4WD) PICKUP (SONOMA) 4.3L

### 9111

Inlet A: LOOSE 2-BOLT FLANGE W/ SPHERICAL FLARE  
 Inlet B: LOOSE 2-BOLT FLANGE W/ SPHERICAL FLARE  
 Outlet A: 2.50" O.D. PIPE  
 Length: 61.50"



2003-00 8 DODGE DURANGO 4.7L

### 9112

Inlet A: LOOSE 2-BOLT FLANGE W/ SPHERICAL FLARE  
 Inlet B: LOOSE 2-BOLT FLANGE W/ SPHERICAL FLARE  
 Outlet A: WELDED 2-BOLT FLANGE W/ GASKET STUB  
 Length: 57.50"



2005-02 6 FORD EXPLORER 4.0L  
 2005-02 6 MERCURY MOUNTAINEER 4.0L

**DIRECT FIT**

**9116**

Inlet A: LOOSE 2-BOLT FLANGE W/ SPHERICAL FLARE  
Inlet B: 2.50" I.D. PIPE  
Outlet A: 2.50" O.D. PIPE  
Length: 47.13"



2000 8 FORD EXPEDITION 4.6L  
2003-01 8 FORD F-150 PICKUP 1/2 TON 4.6L

**9117**

Inlet A: LOOSE 2-BOLT FLANGE W/ SPHERICAL FLARE  
Outlet A: 2.50" O.D. PIPE  
Length: 35.50"



2000 8 FORD EXPEDITION 4.6L  
2003-01 8 FORD F-150 PICKUP 1/2 TON 4.6L

**9118**

Inlet A: 3" I.D. PIPE  
Outlet A: LOOSE 4-BOLT FLANGE W/ 3" MALE BALL  
Length: 21"



1989-86 8 CHEVROLET CAMARO 5.0L  
1989-87 8 CHEVROLET CAMARO 5.7L  
1991-86 8 CHEVROLET CORVETTE 5.7L  
1995-92 8 CHEVROLET FULL SIZE (Inc. Impala RWD, Caprice, Belair, Police, Taxi, Station Wagon) 5.7L  
1989-86 8 PONTIAC FIREBIRD, TRANS AM, FORMULA 5.0L  
1989-87 8 PONTIAC FIREBIRD, TRANS AM, FORMULA 5.7L

**9123**

Inlet A: WELDED 2-BOLT FLANGE  
Outlet A: WELDED 2-BOLT FLANGE W/ GASKET STUB  
Length: 32.88"



1998-96 6 TOYOTA PICKUP (ALL MODELS Exc. TACOMA & TUNDRA) 3.4L

**9126**

Inlet A: LOOSE 2-BOLT FLANGE W/ SPHERICAL FLARE  
Inlet B: LOOSE 2-BOLT FLANGE W/ SPHERICAL FLARE  
Outlet A: 2.50" O.D. PIPE  
Length: 61.50"



2003-00 8 DODGE DURANGO 5.9L

**9130**

Inlet A: LOOSE 3-BOLT FLANGE W/ FEMALE FLARE  
Outlet A: 2.75" O.D. PIPE  
Length: 29.63"



1996-92 8 CHEVROLET CORVETTE 5.7L

**9131**

Inlet A: LOOSE 3-BOLT FLANGE W/ FEMALE FLARE  
Outlet A: LOOSE 3-BOLT FLANGE W/ MALE BALL  
Length: 16"



1996-92 8 CHEVROLET CORVETTE 5.7L

### 9132

Inlet A: LOOSE 3-BOLT FLANGE W/ 45 DEGREE FLARE  
 Inlet B: LOOSE 3-BOLT FLANGE W/ 45 DEGREE FLARE  
 Outlet A: WELDED 3-BOLT FLANGE  
 Length: 53.50"

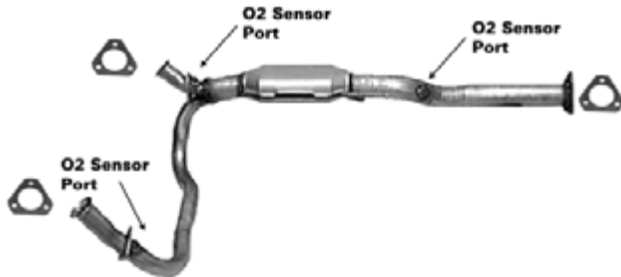

2001-00 6 CHEVROLET ASTRO VAN 4.3L  
 2001-00 6 GMC SAFARI VAN 4.3L

### 9133

Inlet A: 2.25" I.D. PIPE  
 Outlet A: LOOSE 4-BOLT GM FLANGE W/ 2.50" MALE BALL  
 Length: 23"



1991 8 BUICK ROADMASTER 5.0L  
 1993-92 8 BUICK ROADMASTER 5.7L  
 1993 8 CADILLAC COMMERCIAL CHASSIS -  
 FUNERAL COACH, LIMOUSINE All  
 1986 8 CADILLAC FLEETWOOD 5.0L  
 1993 8 CADILLAC FLEETWOOD 5.7L  
 1992-90 8 CHEVROLET CAMARO 5.7L  
 1993-88 8 CHEVROLET FULL SIZE (Inc. Impala RWD,  
 Caprice, Belair, Police, Taxi, Station Wagon) 5.0L  
 1990-83 8 CHEVROLET FULL SIZE (Inc. Impala RWD,  
 Caprice, Belair, Police, Taxi, Station Wagon) 5.7L  
 1986-85 8 PONTIAC PARISIENNE 5.0L

### 9134

Inlet A: WELDED 3-BOLT FLANGE W/ GASKET STUB  
 Outlet A: WELDED 2-BOLT FLANGE  
 Length: 42"



2004-01 8 TOYOTA SEQUOIA 4.7L

### 9135

Inlet A: WELDED 3-BOLT FLANGE W/ GASKET STUB  
 Outlet A: WELDED 2-BOLT FLANGE  
 Length: 57.75"



2004-01 8 TOYOTA SEQUOIA 4.7L

### 9136

Inlet A: LOOSE 2-BOLT FLANGE W/ SPHERICAL FLARE  
 Inlet B: 2.63" O.D. PIPE  
 Outlet A: 2.50" O.D. PIPE  
 Length: 47"



2002-01 8 FORD F-150 PICKUP 1/2 TON 5.4L

### 9137

Inlet A: LOOSE 2-BOLT FLANGE W/ SPHERICAL FLARE  
 Outlet A: 2.50" O.D. PIPE  
 Length: 34.25"



2002-01 8 FORD F-150 PICKUP 1/2 TON 5.4L

### 9138

Inlet A: LOOSE 3-BOLT FLANGE W/ SPHERICAL FLARE  
 Inlet B: LOOSE 3-BOLT FLANGE W/ SPHERICAL FLARE  
 Outlet A: WELDED 3-BOLT FLANGE  
 Length: 68.25"



1999-96 6 CHEVROLET G -VAN 1/2 & 3/4 TON (Inc.

# DIRECT FIT

## 9138 (cont.)

1999-96 6 Express Van) 4.3L  
 GMC G -VAN 1/2 & 3/4 TON (Inc. Savana Van)  
 4.3L

## 9139

Inlet A: 2.50" I.D. PIPE  
 Outlet A: 2.50" O.D. PIPE  
 Length: 32"



2004-02 6 JEEP GRAND CHEROKEE/GRAND  
 WAGONEER 4.0L  
 2004-02 8 JEEP GRAND CHEROKEE/GRAND  
 WAGONEER 4.7L

## 9144

Inlet A: WELDED 3-BOLT FLANGE  
 Outlet A: WELDED 2-BOLT FLANGE W/ GASKET STUB  
 Length: 36.13"



2003-01 6 FORD RANGER 3.0L  
 2003-01 6 FORD RANGER 4.0L  
 2003-01 6 MAZDA B-Series PICKUP 3.0L  
 2003-01 6 MAZDA B-Series PICKUP 4.0L

## 9146

Inlet A: 2.50" I.D. PIPE  
 Outlet A: 2.50" O.D. PIPE  
 Length: 48.25"



1999-98 8 DODGE DURANGO 5.2L  
 1999-98 8 DODGE DURANGO 5.9L

## 9147

Inlet A: 2" I.D. PIPE  
 Outlet A: 2" O.D. PIPE  
 Length: 50.50"



1998-97 4 DODGE DAKOTA 2.5L

## 9148

Inlet A: LOOSE 3-BOLT FLANGE W/ FLARE  
 Inlet B: LOOSE 3-BOLT FLANGE W/ FLARE  
 Outlet A: WELDED 3-BOLT FLANGE  
 Length: 59.75"



2005-00 6 CHEVROLET ASTRO VAN 4.3L  
 2005-00 6 GMC SAFARI VAN 4.3L

## 9149

Inlet A: LOOSE 2-BOLT FLANGE W/ SPHERICAL FLARE  
 Inlet B: LOOSE 2-BOLT FLANGE W/ SPHERICAL FLARE  
 Outlet A: 2.365" O.D. PIPE  
 Outlet B: LOOSE 2-BOLT FLANGE W/ 45 DEGREE FLARE  
 Length: 72.25"



1993-92 8 MERCEDES-BENZ 400 4.2L  
 1993-92 8 MERCEDES-BENZ 500 5.0L  
 1995-94 8 MERCEDES-BENZ S420 4.2L  
 1995-94 8 MERCEDES-BENZ S500 5.0L

## 9150

Inlet A: 2.50" I.D. PIPE  
 Outlet A: 2.25" O.D. PIPE  
 Length: 28"



1999-97 4 JEEP WRANGLER 2.5L  
 1999-97 6 JEEP WRANGLER 4.0L



### 9153

Inlet A: WELDED 2-BOLT FLANGE  
 Outlet A: WELDED 2-BOLT FLANGE W/ GASKET STUB  
 Length: 31.25"



2002-99 6 TOYOTA 4 RUNNER 3.4L

### 9154

Inlet A: LOOSE 3-BOLT FLANGE W/ SPHERICAL FLARE  
 Outlet A: WELDED 2-BOLT FLANGE  
 Length: 50.50"



2005-04 6 BUICK RAINIER 4.2L  
 2005-02 6 CHEVROLET TRAILBLAZER 4.2L  
 2005-02 6 GMC ENVOY 4.2L  
 2005-04 6 ISUZU ASCENDER 4.2L  
 2004-02 6 OLDSMOBILE BRAVADA 4.2L

### 9155

Inlet A: LOOSE 3-BOLT FLANGE W/ FLARE  
 Inlet B: WELDED 3-BOLT FLANGE  
 Outlet A: WELDED 2-BOLT FLANGE  
 Length: 42"



2004-03 8 CHEVROLET SSR 5.3L

### 9156

Inlet A: 2.50" I.D. PIPE  
 Outlet A: 2.25" O.D. PIPE  
 Length: 34.13"



2001-99 8 JEEP GRAND CHEROKEE/GRAND WAGONEER 4.7L

### 9156 (cont.)

2001 6 JEEP GRAND CHEROKEE/GRAND WAGONEER 4.0L

### 9157

Inlet A: LOOSE 2-BOLT FLANGE W/ SPHERICAL FLARE  
 Inlet B: LOOSE 2-BOLT FLANGE W/ SPHERICAL FLARE  
 Outlet A: 2.50" O.D. PIPE  
 Length: 68.75"



1996 6 FORD E-150 VAN 1/2 TON 4.9L  
 1996 6 FORD E-250 VAN 3/4 TON 4.9L  
 1996 6 FORD E-350 VAN 1 TON 4.9L

### 9158

Inlet A: 45 DEGREE SPHERICAL FLARE  
 Outlet A: WELDED 2-BOLT FLANGE  
 Length: 23.50"



2004 6 JEEP LIBERTY 3.7L

### 9159

Inlet A: WELDED 2-BOLT FLANGE W/ GASKET STUB  
 Inlet B: 45 DEGREE FLARE  
 Outlet A: WELDED 2-BOLT FLANGE  
 Length: 57"



2004 6 JEEP LIBERTY 3.7L

### 9160

Inlet A: WELDED 3-BOLT FLANGE W/ SPECIAL FLANGE  
 Outlet A: WELDED 2-BOLT FLANGE  
 Length: 32"



2000-99 6 FORD EXPLORER 4.0L

# DIRECT FIT

## 9161

Inlet A: LOOSE 2-BOLT FLANGE W/ SPHERICAL FLARE  
Inlet B: LOOSE 2-BOLT FLANGE W/ SPHERICAL FLARE  
Outlet A: WELDED 2-BOLT FLANGE  
Length: 56.38"



2007-05 6 JEEP LIBERTY 3.7L

## 9162

Inlet A: WELDED 3-BOLT FLANGE  
Outlet A: LOOSE 2-BOLT FLANGE W/ MALE BALL  
Length: 27.50"



1997-95 8 CHEVROLET CAMARO 5.7L  
1997-95 8 PONTIAC FIREBIRD, TRANS AM, FORMULA 5.7L

## 9163

Inlet A: LOOSE 2-BOLT FLANGE W/ SPHERICAL FLARE  
Inlet B: LOOSE 2-BOLT FLANGE W/ SPHERICAL FLARE  
Outlet A: 2.50" O.D. PIPE  
Length: 32.75"



2005 8 DODGE DAKOTA 4.7L  
2008-06 6 DODGE DAKOTA 3.7L

## 9164

Inlet A: WELDED 3-BOLT FLANGE W/ GASKET STUB  
Outlet A: WELDED 2-BOLT FLANGE W/ GASKET STUB  
Length: 33.38"



2006-05 8 TOYOTA TUNDRA 4.7L

## 9165

Inlet A: WELDED 3-BOLT FLANGE W/ GASKET STUB  
Outlet A: WELDED 2-BOLT FLANGE W/ GASKET STUB  
Length: 49.75"



2006-05 8 TOYOTA TUNDRA 4.7L

## 9166

Inlet A: WELDED 3-BOLT FLANGE  
Outlet A: WELDED 2-BOLT FLANGE  
Length: 39.75"



2006-03 8 HUMMER H2 6.0L

### 9167

Inlet A: WELDED 3-BOLT FLANGE  
 Outlet A: 2.50" O.D. PIPE  
 Length: 51.25"



2006-03 8 HUMMER H2 6.0L

### 9168

Inlet A: LOOSE 2-BOLT FLANGE W/ FLARE  
 Inlet B: 2.25" I.D. PIPE  
 Outlet A: 2.75" O.D. PIPE  
 Length: 54.38"



2005-04 8 DODGE RAM (2WD & 4WD) PICKUP 1/2 & 3/4 TON 5.7L

### 9169

Inlet A: LOOSE 2-BOLT FLANGE W/ FLARE  
 Outlet A: 2.25" O.D. PIPE  
 Length: 45.75"



2005-04 8 DODGE RAM (2WD & 4WD) PICKUP 1/2 & 3/4 TON 5.7L

### 9170

Inlet A: LOOSE 2-BOLT FLANGE W/ SPHERICAL FLARE  
 Inlet B: LOOSE 2-BOLT FLANGE W/ SPHERICAL FLARE  
 Outlet A: WELDED 2-BOLT FLANGE W/ FLARE  
 Length: 50.25"



2006-04 6 JEEP WRANGLER 4.0L

### 9171

Inlet A: LOOSE 3-BOLT FLANGE W/ FLARE  
 Outlet A: WELDED 2-BOLT FLANGE  
 Length: 48.13"



2007-06 6 BUICK RAINIER 4.2L  
 2007-06 6 CHEVROLET TRAILBLAZER 4.2L  
 2007-06 6 GMC ENVOY 4.2L  
 2007-06 6 ISUZU ASCENDER 4.2L  
 2007-06 6 SAAB 9-7X 4.2L

### 9172

Inlet A: LOOSE 2-BOLT FLANGE W/ SPHERICAL FLARE  
 Inlet B: LOOSE 2-BOLT FLANGE W/ SPHERICAL FLARE  
 Outlet A: WELDED 2-BOLT FLANGE W/ GASKET STUB  
 Length: 44.75"



2010-06 6 FORD EXPLORER 4.0L  
 2010-06 6 MERCURY MOUNTAINEER 4.0L

### 9173

Inlet A: LOOSE 2-BOLT FLANGE W/ SPHERICAL FLARE  
 Inlet B: LOOSE 2-BOLT FLANGE W/ SPHERICAL FLARE  
 Outlet A: WELDED 2-BOLT FLANGE W/ GASKET STUB  
 Length: 58.50"



2005-02 8 FORD EXPLORER 4.6L  
 2005-02 8 MERCURY MOUNTAINEER 4.6L

# DIRECT FIT

## 9174

Inlet A: LOOSE 2-BOLT FLANGE W/ SPHERICAL FLARE  
 Outlet A: WELDED 2-BOLT FLANGE W/ GASKET STUB  
 Length: 48.50"



2006-01 4 FORD RANGER 2.3L  
 2006-01 4 MAZDA B-Series PICKUP 2.3L

## 9175

Inlet A: LOOSE 2-BOLT FLANGE W/ SPHERICAL FLARE  
 Inlet B: LOOSE 2-BOLT FLANGE W/ SPHERICAL FLARE  
 Outlet A: 2.50" O.D. PIPE  
 Length: 59.25"



2003-01 8 DODGE DAKOTA 4.7L

## 9176

Inlet A: LOOSE 2-BOLT FLANGE W/ SPHERICAL FLARE  
 Inlet B: LOOSE 2-BOLT FLANGE W/ SPHERICAL FLARE  
 Outlet A: 2.50" O.D. PIPE  
 Length: 59.25"



2003-01 8 DODGE DAKOTA 4.7L

## 9181

Inlet A: WELDED 6-BOLT FLANGE  
 Outlet A: 2.16" O.D. PIPE  
 Length: 42.50"



2001-98 4 VOLKSWAGEN BEETLE 2.0L  
 2001-99 4 VOLKSWAGEN GOLF 2.0L

## 9181 (cont.)

2001-99 4 VOLKSWAGEN JETTA 2.0L

## 9182

Inlet A: 2.50" O.D. PIPE  
 Outlet A: 2.50" O.D. PIPE  
 Length: 25"



1991-84 8 JEEP GRAND CHEROKEE/GRAND WAGONEER 5.9L

## 9184

Inlet A: 3" I.D. PIPE  
 Outlet A: 3" O.D. PIPE  
 Length: 26.25"



- 1993-92 6 CHEVROLET ASTRO VAN 4.3L
- 1994-87 8 CHEVROLET BLAZER FULL SIZE 5.7L
- 1995-88 8 CHEVROLET C-(2WD), K-(4WD) PICKUP 1 TON, (Inc. SILVERADO) All
- 1993-88 8 CHEVROLET C-(2WD), K-(4WD) PICKUP 1/2 TON, (Inc. SILVERADO & AVALANCHE) 5.7L
- 1992-90 8 CHEVROLET C-(2WD), K-(4WD) PICKUP 1/2 TON, (Inc. SILVERADO & AVALANCHE) 7.4L
- 1993-91 6 CHEVROLET C-(2WD), K-(4WD) PICKUP 3/4 TON, (Inc. SILVERADO & AVALANCHE) 4.3L
- 1993-88 8 CHEVROLET C-(2WD), K-(4WD) PICKUP 3/4 TON, (Inc. SILVERADO & AVALANCHE) 5.7L
- 1995-91 8 CHEVROLET C-(2WD), K-(4WD) PICKUP 3/4 TON, (Inc. SILVERADO & AVALANCHE) 7.4L
- 1991-87 8 CHEVROLET G -VAN 1 TON (Inc. Express Van) 5.7L
- 1994-92 8 CHEVROLET G -VAN 1 TON (Inc. Express Van) All
- 1994-87 8 CHEVROLET G -VAN 1/2 & 3/4 TON (Inc. Express Van) 5.7L
- 1989-87 8 CHEVROLET R-(2WD), V-(4WD) PICKUP 5.7L
- 1993-87 8 CHEVROLET SUBURBAN/TAHOE 5.7L
- 1995-87 8 CHEVROLET SUBURBAN/TAHOE 7.4L
- 1995-88 8 GMC C-(2WD), K-(4WD) PICKUP 1 TON, (Inc. SIERRA) All
- 1993-88 8 GMC C-(2WD), K-(4WD) PICKUP 1/2 TON, (Inc. SIERRA) 5.7L
- 1993-91 6 GMC C-(2WD), K-(4WD) PICKUP 3/4 TON, (Inc. SIERRA) 4.3L
- 1993-88 8 GMC C-(2WD), K-(4WD) PICKUP 3/4 TON, (Inc. SIERRA) 5.7L
- 1995-91 8 GMC C-(2WD), K-(4WD) PICKUP 3/4 TON, (Inc. SIERRA) 7.4L
- 1991-87 8 GMC G -VAN 1 TON (Inc. Savana Van) 5.7L
- 1994-92 8 GMC G -VAN 1 TON (Inc. Savana Van) All
- 1994-87 8 GMC G -VAN 1/2 & 3/4 TON (Inc. Savana Van) 5.7L

### 9184 (cont.)

1991-87	8	GMC JIMMY FULL SIZE 5.7L
1993-92	6	GMC SAFARI VAN 4.3L
1993-87	8	GMC SUBURBAN/YUKON 5.7L
1995-87	8	GMC SUBURBAN/YUKON 7.4L

### 9185

Inlet A: 2.50" I.D. PIPE  
 Outlet A: 2.50" O.D. PIPE  
 Length: 59.25"



1999-97	6	DODGE DAKOTA 3.9L
1999	6	DODGE DURANGO 3.9L

### 9186

Inlet A: 3" I.D. PIPE  
 Outlet A: 3" O.D. PIPE  
 Length: 20"



1995-88	8	CHEVROLET C-(2WD), K-(4WD) PICKUP 1 TON, (Inc. SILVERADO) All
1993-88	8	CHEVROLET C-(2WD), K-(4WD) PICKUP 3/4 TON, (Inc. SILVERADO & AVALANCHE) 5.7L
1995-91	8	CHEVROLET C-(2WD), K-(4WD) PICKUP 3/4 TON, (Inc. SILVERADO & AVALANCHE) 7.4L
1991-87	8	CHEVROLET G -VAN 1 TON (Inc. Express Van) 5.7L
1994-87	8	CHEVROLET G -VAN 1/2 & 3/4 TON (Inc. Express Van) 5.7L
1995-88	8	GMC C-(2WD), K-(4WD) PICKUP 1 TON, (Inc. SIERRA) All
1993-88	8	GMC C-(2WD), K-(4WD) PICKUP 3/4 TON, (Inc. SIERRA) 5.7L
1995-91	8	GMC C-(2WD), K-(4WD) PICKUP 3/4 TON, (Inc. SIERRA) 7.4L
1991-87	8	GMC G -VAN 1 TON (Inc. Savana Van) 5.7L
1994-87	8	GMC G -VAN 1/2 & 3/4 TON (Inc. Savana Van) 5.7L

### 9187

Inlet A: LOOSE 3-BOLT FLANGE W/ SPHERICAL FLARE  
 Inlet B: LOOSE 3-BOLT FLANGE W/ SPHERICAL FLARE  
 Outlet A: WELDED 2-BOLT FLANGE W/ GASKET STUB  
 Outlet B: WELDED 2-BOLT FLANGE W/ GASKET STUB  
 Length: 81.50"



2004-00	8	CHEVROLET CORVETTE 5.7L
---------	---	-------------------------

### 9188

Inlet A: WELDED 3-BOLT FLANGE  
 Outlet A: WELDED 3-BOLT FLANGE  
 Length: 60.75"



2005-03	8	CHEVROLET G -VAN 1 TON (Inc. Express Van) 6.0L
2005-03	8	CHEVROLET G -VAN 1/2 & 3/4 TON (Inc. Express Van) 4.8L
2005-03	8	CHEVROLET G -VAN 1/2 & 3/4 TON (Inc. Express Van) 6.0L
2005-03	8	GMC G -VAN 1 TON (Inc. Savana Van) 6.0L
2005-03	8	GMC G -VAN 1/2 & 3/4 TON (Inc. Savana Van) 4.8L
2005-03	8	GMC G -VAN 1/2 & 3/4 TON (Inc. Savana Van) 6.0L

### 9189

Inlet A: WELDED 3-BOLT FLANGE  
 Outlet A: 3" O.D. PIPE  
 Length: 63"



2005-03	8	CHEVROLET G -VAN 1 TON (Inc. Express Van) 6.0L
2005-03	8	CHEVROLET G -VAN 1/2 & 3/4 TON (Inc. Express Van) 4.8L
2005-03	8	CHEVROLET G -VAN 1/2 & 3/4 TON (Inc. Express Van) 6.0L
2005-03	8	GMC G -VAN 1 TON (Inc. Savana Van) 6.0L
2005-03	8	GMC G -VAN 1/2 & 3/4 TON (Inc. Savana Van) 4.8L

# DIRECT FIT

## 9189 (cont.)

2005-03 8 GMC G-VAN 1/2 & 3/4 TON (Inc. Savana Van) 6.0L

## 9190

Inlet A: LOOSE 2-BOLT FLANGE W/ SPHERICAL FLARE  
 Inlet B: 2.50" I.D. PIPE  
 Outlet A: LOOSE 2-BOLT FLANGE W/ SPHERICAL FLARE  
 Length: 45"

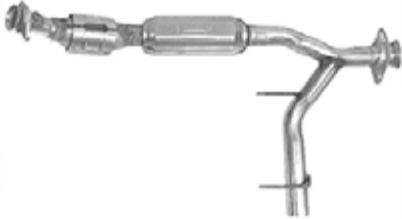

2004-03 8 FORD EXPEDITION 4.6L

## 9191

Inlet A: LOOSE 2-BOLT FLANGE W/ SPHERICAL FLARE  
 Outlet A: 2.50" O.D. PIPE  
 Length: 36.50"



2004-03 8 FORD EXPEDITION 4.6L

## 9192

Inlet A: WELDED 3-BOLT FLANGE  
 Outlet A: 2.3" O.D. PIPE  
 Outlet B: 2.610" O.D. PIPE  
 Length: 33.50"



- 1999-96 8 CHEVROLET C-(2WD), K-(4WD) PICKUP 1 TON, (Inc. SILVERADO) 5.7L
- 1999-96 8 CHEVROLET C-(2WD), K-(4WD) PICKUP 3/4 TON, (Inc. SILVERADO & AVALANCHE) 5.7L
- 1999-96 8 GMC C-(2WD), K-(4WD) PICKUP 1 TON, (Inc. SIERRA) 5.7L
- 1999-96 8 GMC C-(2WD), K-(4WD) PICKUP 3/4 TON, (Inc. SIERRA) 5.7L

## 9193

Inlet A: LOOSE 2-BOLT FLANGE W/ SPHERICAL FLARE  
 Inlet B: LOOSE 2-BOLT FLANGE W/ SPHERICAL FLARE  
 Outlet A: WELDED 2-BOLT FLANGE  
 Length: 38.25"



- 2007-06 6 JEEP COMMANDER 3.7L
- 2006-05 6 JEEP GRAND CHEROKEE/GRAND WAGONEER 3.7L

## 9194

Inlet A: LOOSE 3-BOLT FLANGE W/ SPHERICAL FLARE  
 Inlet B: LOOSE 3-BOLT FLANGE W/ SPHERICAL FLARE  
 Outlet A: WELDED 2-BOLT FLANGE  
 Outlet B: 3" O.D. PIPE  
 Length: 56.63"



2008-05 8 GMC C5500 8.1L

## 9195

Inlet A: WELDED 2-BOLT FLANGE  
 Outlet A: 2.650" O.D. PIPE  
 Length: 23.75"



2008-05 8 GMC C5500 8.1L

### 9196

Inlet A: LOOSE 2-BOLT FLANGE W/ SPHERICAL FLARE  
 Inlet B: LOOSE 2-BOLT FLANGE W/ SPHERICAL FLARE  
 Outlet A: 2.50" O.D. PIPE  
 Length: 59"



2003-00 6 DODGE DAKOTA 3.9L

### 9197

Inlet A: LOOSE 2-BOLT FLANGE W/ SPHERICAL FLARE  
 Inlet B: LOOSE 2-BOLT FLANGE W/ SPHERICAL FLARE  
 Outlet A: 2.50" O.D. PIPE  
 Length: 59"



2003-00 6 DODGE DAKOTA 3.9L

### 9198

Inlet A: LOOSE 2-BOLT FLANGE W/ SPHERICAL FLARE  
 Inlet B: LOOSE 2-BOLT FLANGE W/ SPHERICAL FLARE  
 Outlet A: 2.50" O.D. PIPE  
 Length: 57.50"

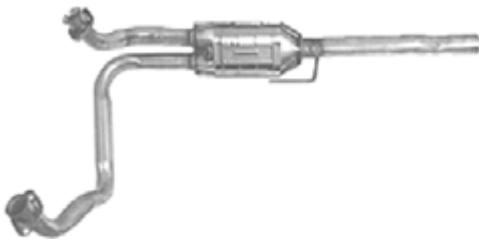

2001-00 8 DODGE RAM (2WD & 4WD) PICKUP 1 TON 5.9L  
 2001-00 8 DODGE RAM (2WD & 4WD) PICKUP 1/2 & 3/4 TON 5.2L  
 2001-00 8 DODGE RAM (2WD & 4WD) PICKUP 1/2 & 3/4 TON 5.9L

### 9199

Inlet A: LOOSE 2-BOLT FLANGE W/ FLARE  
 Inlet B: LOOSE 2-BOLT FLANGE W/ FLARE  
 Outlet A: 3" O.D. PIPE  
 Length: 62.75"



2003 8 DODGE RAM (2WD & 4WD) PICKUP 1/2 & 3/4 TON 5.7L

### 9202

Inlet A: LOOSE 2-BOLT FLANGE W/ 2.50" FEMALE FLARE  
 Inlet B: LOOSE 2-BOLT FLANGE W/ 2.50" FEMALE FLARE  
 Outlet A: 2.50" O.D. PIPE  
 Length: 57"



1995-88 8 FORD E-150 VAN 1/2 TON 5.8L  
 1995-88 8 FORD E-250 VAN 3/4 TON 5.8L

### 9203

Inlet A: WELDED 3-BOLT FLANGE W/ FLARE  
 Inlet B: WELDED 3-BOLT FLANGE W/ FLARE  
 Outlet A: WELDED 2-BOLT FLANGE  
 Outlet B: WELDED 2-BOLT FLANGE  
 Length: 81.50"



2004-00 8 CHEVROLET CORVETTE 5.7L

# DIRECT FIT

## 9204

Inlet A: (4) WELDED 2-BOLT FLANGES  
 Outlet A: 2-BOLT FLANGE W/ MALE BALL  
 Length: 28"



1998-97 8 LINCOLN MARK Series 4.6L

## 9205

Inlet A: 2.50" I.D. PIPE  
 Outlet A: 2.50" O.D. PIPE  
 Length: 59.50"



1996 6 DODGE DAKOTA 3.9L  
 1996 8 DODGE DAKOTA 5.2L

## 9206

Inlet A: LOOSE 2-BOLT FLANGE W/ FLARE  
 Inlet B: 2.25" I.D. PIPE  
 Outlet A: 2.50" O.D. PIPE  
 Length: 55.50"



2005-04 6 DODGE RAM (2WD & 4WD) PICKUP 1/2 & 3/4 TON 3.7L  
 2005-04 8 DODGE RAM (2WD & 4WD) PICKUP 1/2 & 3/4 TON 4.7L

## 9207

Inlet A: LOOSE 2-BOLT FLANGE W/ FLARE  
 Outlet A: 2.25" O.D. PIPE  
 Length: 45"



2005-04 6 DODGE RAM (2WD & 4WD) PICKUP 1/2 & 3/4

## 9207 (cont.)

TON 3.7L  
 2005-04 8 DODGE RAM (2WD & 4WD) PICKUP 1/2 & 3/4 TON 4.7L

## 9208

Inlet A: WELDED 3-BOLT FLANGE  
 Outlet A: WELDED 3-BOLT FLANGE  
 Length: 68.25"



2005-03 8 CHEVROLET G -VAN 1 TON (Inc. Express Van) 6.0L  
 2005-03 8 CHEVROLET G -VAN 1/2 & 3/4 TON (Inc. Express Van) 4.8L  
 2005-03 8 CHEVROLET G -VAN 1/2 & 3/4 TON (Inc. Express Van) 6.0L  
 2005-03 8 GMC G -VAN 1 TON (Inc. Savana Van) 6.0L  
 2005-03 8 GMC G -VAN 1/2 & 3/4 TON (Inc. Savana Van) 4.8L  
 2005-03 8 GMC G -VAN 1/2 & 3/4 TON (Inc. Savana Van) 6.0L

## 9209

Inlet A: LOOSE 3-BOLT FLANGE W/ SPHERICAL FLARE  
 Inlet B: LOOSE 3-BOLT FLANGE W/ SPHERICAL FLARE  
 Outlet A: WELDED 2-BOLT FLANGE  
 Length: 57.25"



2005-01 6 CHEVROLET BLAZER S-Series 4.3L  
 2002-01 6 GMC S-15 JIMMY 4.3L

## 9210

Inlet A: LOOSE 3-BOLT FANGE W/ SPHERICAL FLARE  
 Inlet B: LOOSE 3-BOLT FANGE W/ SPHERICAL FLARE  
 Outlet A: WELDED 2-BOLT FLANGE  
 Length: 57.25"

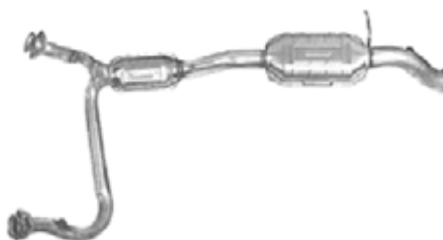

2005-01 6 CHEVROLET BLAZER S-Series 4.3L  
 2002-01 6 GMC S-15 JIMMY 4.3L



### 9211

Inlet A: LOOSE 2-BOLT FLANGE W/ SPHERICAL FLARE  
 Inlet B: LOOSE 2-BOLT FLANGE W/ SPHERICAL FLARE  
 Outlet A: 2-1/2" O.D. PIPE  
 Length: 61.75"



2003-00 8 DODGE DURANGO 4.7L  
 2003-00 8 DODGE DURANGO 4.7L

### 9212

Inlet A: WELDED 2-BOLT FLANGE  
 Outlet A: 2.580" O.D. PIPE  
 Length: 26.25"



2000-99 8 CHEVROLET C-(2WD), K-(4WD) PICKUP 3/4 TON, (Inc. SILVERADO & AVALANCHE) 6.0L  
 2000-99 8 GMC C-(2WD), K-(4WD) PICKUP 3/4 TON, (Inc. SIERRA) 6.0L

### 9213

Inlet A: WELDED 3-BOLT FLANGE  
 Outlet A: 2.75" O.D. PIPE  
 Length: 63.50"



2001-99 8 CHEVROLET C-(2WD), K-(4WD) PICKUP 3/4 TON, (Inc. SILVERADO & AVALANCHE) 6.0L  
 2002-01 8 CHEVROLET SUBURBAN/TAHOE 6.0L  
 2001-99 8 GMC C-(2WD), K-(4WD) PICKUP 3/4 TON, (Inc. SIERRA) 6.0L

### 9214

Inlet A: LOOSE 3-BOLT FLANGE W/ SPHERICAL FLARE  
 Inlet B: LOOSE 3-BOLT FLANGE W/ SPHERICAL FLARE  
 Outlet A: WELDED 2-BOLT FLANGE  
 Length: 58"



2005-00 6 CHEVROLET BLAZER S-Series 4.3L  
 2002-00 6 GMC S-15 JIMMY 4.3L

### 9215

Inlet A: LOOSE 3-BOLT FLANGE W/ SPHERICAL FLARE  
 Inlet B: LOOSE 3-BOLT FLANGE W/ SPHERICAL FLARE  
 Outlet A: WELDED 2-BOLT FLANGE  
 Length: 58.50"



2000 6 CHEVROLET BLAZER S-Series 4.3L  
 2000 6 GMC S-15 JIMMY 4.3L

### 9216

Inlet A: LOOSE 3-BOLT FLANGE W/ SPHERICAL FLARE  
 Outlet A: WELDED 2-BOLT FLANGE  
 Length: 58.50"



2006-04 4 CHEVROLET COLORADO 2.8L  
 2006-04 5 CHEVROLET COLORADO 3.5L  
 2006-04 4 GMC CANYON 2.8L  
 2006-04 5 GMC CANYON 3.5L  
 2007 5 HUMMER H3 3.7L  
 2006 4 ISUZU I-280 2.8L  
 2006 5 ISUZU I-350 3.5L

# DIRECT FIT

## 9217

Inlet A: WELDED 2-BOLT FLANGE  
 Outlet A: 2.25" O.D. PIPE  
 Length: 24.75"



2004 6 MITSUBISHI ENDEAVOR 3.8L

## 9218

Inlet A: WELDED 2-BOLT FLANGE  
 Outlet A: 2.25" O.D. PIPE  
 Length: 29.50"



2008-07 4 DODGE CALIBER 2.4L  
 2008-07 4 JEEP COMPASS 2.0L  
 2009-07 4 JEEP COMPASS 2.4L  
 2008-07 4 JEEP PATRIOT 2.0L  
 2008-07 4 JEEP PATRIOT 2.4L

## 9219

Inlet A: LOOSE 2-BOLT FLANGE W/ SPHERICAL FLARE  
 Outlet A: LOOSE 3-BOLT FLANGE W/ 45 DEGREE FLARE  
 Length: 58.25"



1996-94 4 MERCEDES-BENZ C220 2.2L  
 1997 4 MERCEDES-BENZ C230 2.3L

## 9220

Inlet A: WELDED 2-BOLT FLANGE  
 Outlet A: 2.4" O.D. PIPE  
 Length: 22.38"



2002-01 8 CHEVROLET SUBURBAN/TAHOE 6.0L

## 9221

Inlet A: 2-BOLT FLANGE W/ SPHERICAL FLARE  
 Inlet B: 2-BOLT FLANGE W/ SPHERICAL FLARE  
 Outlet A: 3-BOLT FLANGE W/ 45 DEGREE FLARE  
 Length: 67"



1997-94 6 MERCEDES-BENZ C280 2.8L

## 9222

Inlet A: WELDED 2-BOLT FLANGE  
 Outlet A: 2.85" O.D. PIPE  
 Length: 30.50"



2006-04 8 CHEVROLET C-(2WD), K-(4WD) PICKUP 1 TON, (Inc. SILVERADO) 6.0L  
 2006-04 8 CHEVROLET C-(2WD), K-(4WD) PICKUP 1 TON, (Inc. SILVERADO) 8.1L  
 2006-02 8 CHEVROLET C-(2WD), K-(4WD) PICKUP 1/2 TON, (Inc. SILVERADO & AVALANCHE) 6.0L  
 2006-01 8 CHEVROLET C-(2WD), K-(4WD) PICKUP 3/4 TON, (Inc. SILVERADO & AVALANCHE) 6.0L  
 2006-01 8 CHEVROLET C-(2WD), K-(4WD) PICKUP 3/4 TON, (Inc. SILVERADO & AVALANCHE) 8.1L  
 2007 8 CHEVROLET SILVERADO 2500 HD CLASSIC 6.0L  
 2007 8 CHEVROLET SILVERADO 2500 HD CLASSIC 8.1L  
 2007 8 CHEVROLET SILVERADO 3500 CLASSIC 6.0L  
 2007 8 CHEVROLET SILVERADO 3500 CLASSIC 8.1L  
 2006-02 8 GMC C-(2WD), K-(4WD) PICKUP 1/2 TON, (Inc. SIERRA) 6.0L  
 2006-01 8 GMC C-(2WD), K-(4WD) PICKUP 3/4 TON, (Inc. SIERRA) 6.0L  
 2006-01 8 GMC C-(2WD), K-(4WD) PICKUP 3/4 TON, (Inc. SIERRA) 8.1L  
 2007 8 GMC SIERRA 2500 HD CLASSIC 6.0L  
 2007 8 GMC SIERRA 2500 HD CLASSIC 8.1L  
 2007 8 GMC SIERRA 3500 CLASSIC 6.0L  
 2007 8 GMC SIERRA 3500 CLASSIC 8.1L

### 9223

Inlet A: WELDED 3-BOLT FLANGE  
 Outlet A: 3" O.D. PIPE  
 Length: 57"



- |         |   |  |
|---------|---|--|
| 2006-04 | 8 | CHEVROLET C-(2WD), K-(4WD) PICKUP 1 TON, (Inc. SILVERADO) 6.0L               |
| 2006-04 | 8 | CHEVROLET C-(2WD), K-(4WD) PICKUP 1 TON, (Inc. SILVERADO) 8.1L               |
| 2006-02 | 8 | CHEVROLET C-(2WD), K-(4WD) PICKUP 1/2 TON, (Inc. SILVERADO & AVALANCHE) 6.0L |
| 2006-01 | 8 | CHEVROLET C-(2WD), K-(4WD) PICKUP 3/4 TON, (Inc. SILVERADO & AVALANCHE) 6.0L |
| 2006-01 | 8 | CHEVROLET C-(2WD), K-(4WD) PICKUP 3/4 TON, (Inc. SILVERADO & AVALANCHE) 8.1L |
| 2007    | 8 | CHEVROLET SILVERADO 2500 HD CLASSIC 6.0L                                     |
| 2007    | 8 | CHEVROLET SILVERADO 2500 HD CLASSIC 8.1L                                     |
| 2007    | 8 | CHEVROLET SILVERADO 3500 CLASSIC 6.0L  |
| 2007    | 8 | CHEVROLET SILVERADO 3500 CLASSIC 8.1L  |
| 2006-02 | 8 | GMC C-(2WD), K-(4WD) PICKUP 1/2 TON, (Inc. SIERRA) 6.0L                      |
| 2006-01 | 8 | GMC C-(2WD), K-(4WD) PICKUP 3/4 TON, (Inc. SIERRA) 6.0L                      |
| 2006-01 | 8 | GMC C-(2WD), K-(4WD) PICKUP 3/4 TON, (Inc. SIERRA) 8.1L                      |
| 2007    | 8 | GMC SIERRA 2500 HD CLASSIC 6.0L  |
| 2007    | 8 | GMC SIERRA 2500 HD CLASSIC 8.1L  |
| 2007    | 8 | GMC SIERRA 3500 CLASSIC 6.0L   |
| 2007    | 8 | GMC SIERRA 3500 CLASSIC 8.1L   |

### 9224

Inlet A: WELDED 2-BOLT FLANGE  
 Outlet A: 2" O.D. PIPE  
 Length: 21.38"



- |         |   |                        |
|---------|---|------------------------|
| 2006-04 | 6 | LEXUS RX330 3.3L       |
| 2007-04 | 6 | TOYOTA HIGHLANDER 3.3L |

### 9225

Inlet A: WELDED 3-BOLT FLANGE  
 Outlet A: WELDED 2-BOLT FLANGE W/ GASKET STUB  
 Length: 18.75" (W/ STUDS)

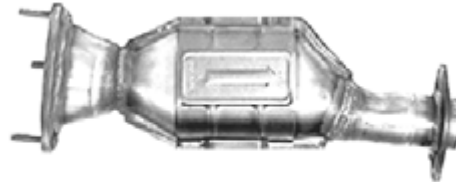

- |         |   |                            |
|---------|---|----------------------------|
| 2006-04 | 6 | FORD RANGER 3.0L           |
| 2006-04 | 6 | FORD RANGER 4.0L           |
| 2006-04 | 6 | MAZDA B-Series PICKUP 3.0L |
| 2006-04 | 6 | MAZDA B-Series PICKUP 4.0L |

### 9226

Inlet A: LOOSE 2-BOLT FLANGE W/ SPHERICAL FLARE  
 Inlet B: LOOSE 2-BOLT FLANGE W/ SPHERICAL FLARE  
 Outlet A: 2-1/2" O.D. PIPE  
 Length: 59.25"



- |         |   |                   |
|---------|---|-------------------|
| 2003-00 | 6 | DODGE DAKOTA 3.9L |
|---------|---|-------------------|

### 9227

Inlet A: LOOSE 3-BOLT FLANGE W/ SPHERICAL FLARE  
 Inlet B: LOOSE 3-BOLT FLANGE W/ SPHERICAL FLARE  
 Outlet A: WELDED 2-BOLT FLANGE  
 Length: 59.25"



- |      |   |   |
|------|---|---|
| 2000 | 6 | CHEVROLET S-Series (2WD), T-Series (4WD) PICKUP 4.3L    |
| 2000 | 6 | GMC S-Series (2WD), T-Series (4WD) PICKUP (SONOMA) 4.3L |

# DIRECT FIT

## 9228

Inlet A: LOOSE 3-BOLT FLANGE W/ SPHERICAL FLARE  
 Inlet B: LOOSE 3-BOLT FLANGE W/ SPHERICAL FLARE  
 Outlet A: WELDED 2-BOLT FLANGE  
 Length: 56"



- |      |   |   |
|------|---|---|
| 2000 | 6 | CHEVROLET S-Series (2WD), T-Series (4WD) PICKUP 4.3L    |
| 2000 | 6 | GMC S-Series (2WD), T-Series (4WD) PICKUP (SONOMA) 4.3L |

## 9229

Inlet A: LOOSE 3-BOLT FLANGE W/ SPHERICAL FLARE  
 Inlet B: LOOSE 3-BOLT FLANGE W/ SPHERICAL FLARE  
 Outlet A: WELDED 2-BOLT FLANGE  
 Length: 54.50"



- |      |   |                                |
|------|---|--------------------------------|
| 2000 | 6 | CHEVROLET BLAZER S-Series 4.3L |
| 2000 | 6 | GMC S-15 JIMMY 4.3L            |

## 9230

Inlet A: LOOSE 3-BOLT FLANGE W/ SPHERICAL FLARE  
 Inlet B: LOOSE 3-BOLT FLANGE W/ SPHERICAL FLARE  
 Outlet A: WELDED 2-BOLT FLANGE  
 Length: 56"

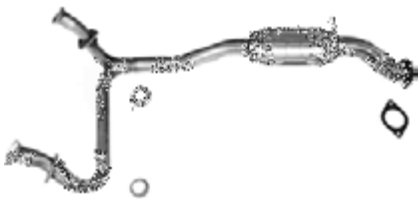

- |      |   |                                |
|------|---|--------------------------------|
| 2000 | 6 | CHEVROLET BLAZER S-Series 4.3L |
| 2000 | 6 | GMC S-15 JIMMY 4.3L            |

## 9231

Inlet A: WELDED 3-BOLT FLANGE  
 Outlet A: WELDED 2-BOLT FLANGE  
 Length: 18.50"



- |         |   |                    |
|---------|---|--------------------|
| 2001-00 | 6 | JEEP CHEROKEE 4.0L |
|---------|---|--------------------|

## 9232

Inlet A: WELDED 2-BOLT FLANGE  
 Outlet A: WELDED 2-BOLT FLANGE W/ GASKET STUB  
 Length: 80.75"



- |         |   |                  |
|---------|---|------------------|
| 2003-99 | 6 | LEXUS RX300 3.0L |
|---------|---|------------------|

## 9233

Inlet A: LOOSE 3-BOLT FLANGE W/ SPHERICAL FLARE  
 Inlet B: WELDED 3-BOLT FLANGE  
 Outlet A: WELDED 2-BOLT FLANGE  
 Length: 36"



- |         |   |  |
|---------|---|--|
| 2008    | 6 | CHEVROLET C-(2WD), K-(4WD) PICKUP 1/2 TON, (Inc. SILVERADO & AVALANCHE) 4.3L |
| 2008-07 | 8 | CHEVROLET C-(2WD), K-(4WD) PICKUP 1/2 TON, (Inc. SILVERADO & AVALANCHE) 4.8L |
| 2008-07 | 8 | CHEVROLET C-(2WD), K-(4WD) PICKUP 1/2 TON, (Inc. SILVERADO & AVALANCHE) 5.3L |
| 2008-07 | 8 | CHEVROLET C-(2WD), K-(4WD) PICKUP 1/2 TON, (Inc. SILVERADO & AVALANCHE) 6.0L |
| 2008-07 | 8 | CHEVROLET SUBURBAN/TAHOE 4.8L  |
| 2008-07 | 8 | CHEVROLET SUBURBAN/TAHOE 5.3L  |
| 2008-07 | 8 | CHEVROLET SUBURBAN/TAHOE 6.0L  |
| 2008    | 6 | GMC C-(2WD), K-(4WD) PICKUP 1/2 TON, (Inc. SIERRA) 4.3L                      |
| 2008-07 | 8 | GMC C-(2WD), K-(4WD) PICKUP 1/2 TON, (Inc. SIERRA) 4.8L                      |
| 2008-07 | 8 | GMC C-(2WD), K-(4WD) PICKUP 1/2 TON, (Inc. SIERRA) 5.3L                      |
| 2008-07 | 8 | GMC C-(2WD), K-(4WD) PICKUP 1/2 TON, (Inc. SIERRA) 6.0L                      |
| 2008-07 | 8 | GMC SUBURBAN/YUKON 4.8L  |

### 9233 (cont.)

2008-07 8 GMC SUBURBAN/YUKON 5.3L  
 2008-07 8 GMC SUBURBAN/YUKON 6.0L

### 9236

Inlet A: LOOSE 2-BOLT FLANGE W/ SPHERICAL FLARE  
 Inlet B: 2.50" I.D. PIPE  
 Outlet A: 2.50" O.D. PIPE  
 Length: 46.75"



2000-98 8 FORD F-150 PICKUP 1/2 TON 5.4L  
 1999-98 8 FORD F-250 PICKUP 3/4 TON 5.4L

### 9237

Inlet A: LOOSE 2-BOLT FLANGE W/ SPHERICAL FLARE  
 Outlet A: 2.50" O.D. PIPE  
 Length: 35"



2000-98 8 FORD F-150 PICKUP 1/2 TON 5.4L  
 1999-98 8 FORD F-250 PICKUP 3/4 TON 5.4L

### 9238

Inlet A: WELDED 2-BOLT FLANGE  
 Outlet A: WELDED 2-BOLT FLANGE  
 Length: 11.50"



1997-96 6 LEXUS LX450 4.5L  
 1997-95 6 TOYOTA LAND CRUISER 4.5L

### 9239

Inlet A: LOOSE 2-BOLT FLANGE W/ SPHERICAL FLARE  
 Inlet B: LOOSE 2-BOLT FLANGE W/ SPHERICAL FLARE  
 Outlet A: 2.50" O.D. PIPE  
 Length: 56.25"



2008 6 DODGE NITRO 3.7L  
 2008 6 JEEP LIBERTY 3.7L

### 9240

Inlet A: WELDED 2-BOLT FLANGE  
 Outlet A: WELDED 2-BOLT FLANGE W/ GASKET STUB  
 Length: 31.75"



2004-00 4 TOYOTA TACOMA 2.7L  
 2004-99 4 TOYOTA TACOMA 2.4L

### 9241

Inlet A: 2-BOLT FLANGE W/ SPHERICAL FLARE  
 Inlet B: 2-BOLT FLANGE W/ SPHERICAL FLARE  
 Outlet A: 2.50" O.D. PIPE  
 Length: 57.50"



1996-92 8 FORD E-150 VAN 1/2 TON 5.0L

# DIRECT FIT

## 9242

Inlet A: LOOSE 2-BOLT FLANGE W/ SPHERICAL FLARE  
Inlet B: 2.50" I.D. PIPE  
Outlet A: 2.50" O.D. PIPE  
Length: 49"

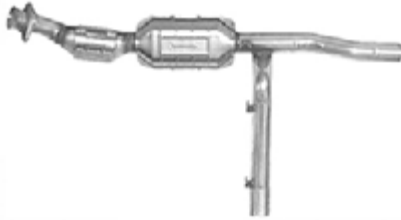

1998-97 6 FORD F-150 PICKUP 1/2 TON 4.2L

## 9243

Inlet A: LOOSE 2-BOLT FLANGE W/ SPHERICAL FLARE  
Outlet A: 2.50" O.D. PIPE  
Length: 36.75"



1998-97 6 FORD F-150 PICKUP 1/2 TON 4.2L

## 9244

Inlet A: WELDED 3-BOLT FLANGE  
Outlet A: WELDED 2-BOLT FLANGE W/ GASKET STUB  
Length: 32.50"



2002-98 6 FORD EXPLORER 4.0L  
2001-98 6 MERCURY MOUNTAINEER 4.0L

## 9245

Inlet A: LOOSE 2-BOLT FLANGE W/ SPHERICAL FLARE  
Inlet B: LOOSE 2-BOLT FLANGE W/ SPHERICAL FLARE  
Outlet A: 2-1/2" O.D. PIPE  
Length: 60.50"

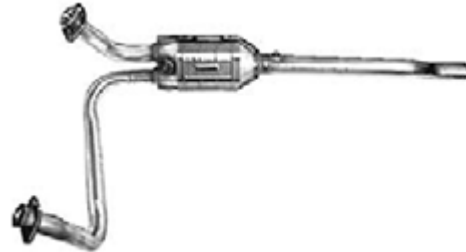

2003-02 8 DODGE RAM (2WD & 4WD) PICKUP 1/2 & 3/4 TON 4.7L

## 9246

Inlet A: LOOSE 2-BOLT FLANGE W/ SPHERICAL FLARE  
Inlet B: LOOSE 2-BOLT FLANGE W/ SPHERICAL FLARE  
Outlet A: WELDED 4-BOLT FLANGE  
Length: 41"



2006-05 8 FORD F-350 PICKUP 1 TON 5.4L

## 9248

Inlet A: LOOSE 2-BOLT FLANGE W/ SPHERICAL FLARE  
Inlet B: 2-1/2" I.D. PIPE  
Outlet A: LOOSE 2-BOLT FLANGE W/ SPHERICAL FLARE  
Length: 45.50"



2004-03 8 FORD EXPEDITION 5.4L

### 9249

Inlet A: LOOSE 2-BOLT FLANGE W/ SPHERICAL FLARE  
 Outlet A: 2-1/2" O.D. PIPE  
 Length: 35.25"



2004-03 8 FORD EXPEDITION 5.4L

### 9250

Inlet A: LOOSE 2-BOLT FLANGE W/ SPHERICAL FLARE  
 Inlet B: 2.50" I.D. PIPE  
 Outlet A: 2.50" O.D. PIPE  
 Length: 46.25"



2002-01 8 FORD EXPEDITION 5.4L  
 2002-01 8 LINCOLN NAVIGATOR 5.4L

### 9251

Inlet A: LOOSE 2-BOLT FLANGE W/ SPHERICAL FLARE  
 Outlet A: 2.50" O.D. PIPE  
 Length: 45.25"

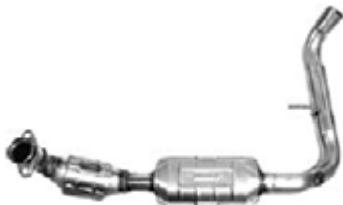

2002-01 8 FORD EXPEDITION 5.4L  
 2002-01 8 LINCOLN NAVIGATOR 5.4L

### 9253

Inlet A: WELDED 3-BOLT FLANGE  
 Outlet A: 2.85" O.D. PIPE  
 Length: 17"



2000 8 CHEVROLET SUBURBAN/TAHOE 6.0L  
 2000 8 GMC SUBURBAN/YUKON 6.0L

### 9254

Inlet A: LOOSE 3-BOLT FLANGE W/ SPHERICAL FLARE  
 Outlet A: WELDED 2-BOLT FLANGE  
 Length: 60"



2005-02 6 CHEVROLET TRAILBLAZER EXT 4.2L  
 2005-02 6 GMC ENVOY XL 4.2L  
 2005-04 6 GMC ENVOY XUV 4.2L

### 9255

Inlet A: LOOSE 2-BOLT FLANGE W/ SPHERICAL FLARE  
 Outlet A: WELDED 2-BOLT FLANGE W/ GASKET STUB  
 Length: 48.75"



2011-07 4 FORD RANGER 2.3L  
 2009-07 4 MAZDA B-Series PICKUP 2.3L

### 9256

Inlet A: LOOSE 2-BOLT FLANGE W/ SPHERICAL FLARE  
 Inlet B: 2.50" I.D. PIPE  
 Outlet A: 2.50" O.D. PIPE  
 Length: 48.50"



2008-05 8 FORD F-150 PICKUP 1/2 TON 5.4L  
 2008-06 8 LINCOLN MARK LT 5.4L

# DIRECT FIT

## 9257

Inlet A: LOOSE 2-BOLT FLANGE W/ SPHERICAL FLARE  
Outlet A: 2.50" O.D. PIPE  
Length: 36.50"



2008-05 8 FORD F-150 PICKUP 1/2 TON 5.4L  
2008-06 8 LINCOLN MARK LT 5.4L

## 9258

Inlet A: LOOSE 2-BOLT FLANGE W/ SPHERICAL FLARE  
Inlet B: 2.50" I.D. PIPE  
Outlet A: 2.50" O.D. PIPE  
Length: 48.75"



2008-05 6 FORD F-150 PICKUP 1/2 TON 4.2L

## 9259

Inlet A: LOOSE 2-BOLT FLANGE W/ SPHERICAL FLARE  
Outlet A: 2.50" O.D. PIPE  
Length: 40"



2008-05 6 FORD F-150 PICKUP 1/2 TON 4.2L

## 9260

Inlet A: LOOSE 2-BOLT FLANGE W/ SPHERICAL FLARE  
Inlet B: 2.50" I.D. PIPE  
Outlet A: 2.50" O.D. PIPE  
Length: 49.50"



2005-04 8 FORD F-150 PICKUP 1/2 TON 4.6L

## 9261

Inlet A: LOOSE 2-BOLT FLANGE W/ SPHERICAL FLARE  
Outlet A: 2.50" O.D. PIPE  
Length: 36.75"



2005-04 8 FORD F-150 PICKUP 1/2 TON 4.6L

## 9262

Inlet A: LOOSE 2-BOLT FLANGE W/ SPHERICAL FLARE  
Outlet A: WELDED 2-BOLT FLANGE W/ GASKET STUB  
Length: 36"



2003-02 6 SUZUKI XL-7 2.7L



### 9263

Inlet A: LOOSE 2-BOLT FLANGE W/ SPHERICAL FLARE  
 Inlet B: LOOSE 2-BOLT FLANGE W/ SPHERICAL FLARE  
 Outlet A: 3" O.D. PIPE  
 Length: 42"



2008-05 8 FORD E-150 VAN 1/2 TON 5.4L  
 2009-05 8 FORD E-250 VAN 3/4 TON 5.4L  
 2009-05 8 FORD E-350 VAN 1 TON 5.4L

### 9264

Inlet A: LOOSE 2-BOLT FLANGE W/ SPHERICAL FLARE  
 Inlet B: LOOSE 2-BOLT FLANGE W/ SPHERICAL FLARE  
 Outlet A: 2.50" O.D. PIPE  
 Length: 48.25"



2008-07 8 FORD E-150 VAN 1/2 TON 4.6L  
 2008-07 8 FORD E-250 VAN 3/4 TON 4.6L

### 9265

Inlet A: WELDED 2-BOLT FLANGE  
 Outlet A: WELDED 2-BOLT FLANGE  
 Length: 20.50"



2002-01 6 MITSUBISHI MONTERO 3.5L

### 9266

Inlet A: WELDED 3-BOLT FLANGE  
 Outlet A: WELDED 2-BOLT FLANGE  
 Length: 40.50"



2006-02 8 CADILLAC ESCALADE 6.0L  
 2006-03 8 CHEVROLET C-(2WD), K-(4WD) PICKUP 1/2 TON, (Inc. SILVERADO & AVALANCHE) 6.0L  
 2006-01 8 GMC SUBURBAN/YUKON 6.0L

### 9267

Inlet A: WELDED 3-BOLT FLANGE  
 Outlet A: 2.50" O.D. PIPE  
 Length: 51.25"



2006-02 8 CADILLAC ESCALADE 6.0L  
 2006-03 8 CHEVROLET C-(2WD), K-(4WD) PICKUP 1/2 TON, (Inc. SILVERADO & AVALANCHE) 6.0L  
 2006-01 8 GMC SUBURBAN/YUKON 6.0L

### 9268

Inlet A: LOOSE 2-BOLT FLANGE W/ SPHERICAL FLARE  
 Inlet B: 2.50" I.D. PIPE  
 Outlet A: 2.50" O.D. PIPE  
 Length: 49.50"



2008-04 8 FORD F-150 PICKUP 1/2 TON 5.4L  
 2008-06 8 LINCOLN MARK LT 5.4L

**DIRECT FIT**

**9269**

Inlet A: LOOSE 2-BOLT FLANGE W/ SPHERICAL FLARE  
Outlet A: 2.50" O.D. PIPE  
Length: 35.25"



2008-04 8 FORD F-150 PICKUP 1/2 TON 5.4L  
2008-06 8 LINCOLN MARK LT 5.4L

**9272**

Inlet A: WELDED 4-BOLT FLANGE  
Outlet A: 2.50" I.D. PIPE  
Outlet B: 2.50" I.D. PIPE  
Length: 43.50"



2007-06 8 WORKHORSE W42 4.8L

**9273**

Inlet A: LOOSE 3-BOLT FLANGE W/ FLARE  
Inlet B: WELDED 3-BOLT FLANGE  
Outlet A: 3" MALE BALL  
Length: 55"



2013-09 6 CHEVROLET C-(2WD), K-(4WD) PICKUP 1/2 TON, (Inc. SILVERADO & AVALANCHE) 4.3L  
2013-09 8 CHEVROLET C-(2WD), K-(4WD) PICKUP 1/2 TON, (Inc. SILVERADO & AVALANCHE) 4.8L  
2013-09 8 CHEVROLET C-(2WD), K-(4WD) PICKUP 1/2 TON, (Inc. SILVERADO & AVALANCHE) 5.3L  
2009 8 CHEVROLET SUBURBAN/TAHOE 4.8L  
2014-09 8 CHEVROLET SUBURBAN/TAHOE 5.3L  
2013-09 6 GMC C-(2WD), K-(4WD) PICKUP 1/2 TON, (Inc. SIERRA) 4.3L  
2013-09 8 GMC C-(2WD), K-(4WD) PICKUP 1/2 TON, (Inc. SIERRA) 4.8L  
2013-09 8 GMC C-(2WD), K-(4WD) PICKUP 1/2 TON, (Inc. SIERRA) 5.3L  
2009 8 GMC SUBURBAN/YUKON 4.8L

**9273 (cont.)**

2014-09 8 GMC SUBURBAN/YUKON 5.3L

**9274**

Inlet A: LOOSE 2-BOLT FLANGE  
Inlet B: 2.50" O.D. PIPE  
Outlet A: 2.75" O.D. PIPE  
Length: 55"



2005-04 8 DODGE DURANGO 5.7L

**9275**

Inlet A: LOOSE 2-BOLT FLANGE  
Outlet A: 2-1/2" I.D. PIPE  
Length: 36"



2005-04 8 DODGE DURANGO 5.7L

**9276**

Inlet A: WELDED 2-BOLT FLANGE  
Outlet A: 2.80" I.D. PIPE  
Length: 18.75"



2002-01 8 CHEVROLET C-(2WD), K-(4WD) PICKUP 3/4 TON, (Inc. SILVERADO & AVALANCHE) 6.0L  
2002-01 8 GMC C-(2WD), K-(4WD) PICKUP 3/4 TON, (Inc. SIERRA) 6.0L

### 9277

Inlet A: WELDED 3-BOLT FLANGE  
 Outlet A: 3" O.D. PIPE  
 Length: 55.75"



- 2002-01 8 CHEVROLET C-(2WD), K-(4WD) PICKUP 3/4 TON, (Inc. SILVERADO & AVALANCHE) 6.0L
- 2002-01 8 GMC C-(2WD), K-(4WD) PICKUP 3/4 TON, (Inc. SIERRA) 6.0L

### 9278

Inlet A: LOOSE 3-BOLT FLANGE W/ FLARE  
 Inlet B: LOOSE 3-BOLT FLANGE W/ FLARE  
 Outlet A: WELDED 2-BOLT FLANGE  
 Length: 57.50"



- 2002 8 CHEVROLET G -VAN 1/2 & 3/4 TON (Inc. Express Van) 5.7L
- 2002 8 GMC G -VAN 1/2 & 3/4 TON (Inc. Savana Van) 5.7L

### 9279

Inlet A: LOOSE 3-BOLT FLANGE  
 Inlet B: WELDED 3-BOLT FLANGE  
 Outlet A: WELDED 2-BOLT FLANGE  
 Length: 69"



- 2012-11 8 CHEVROLET G -VAN 1 TON (Inc. Express Van) 6.0L
- 2012-11 8 CHEVROLET G -VAN 1/2 & 3/4 TON (Inc. Express Van) 6.0L
- 2012-11 8 GMC G -VAN 1 TON (Inc. Savana Van) 6.0L
- 2012-11 8 GMC G -VAN 1/2 & 3/4 TON (Inc. Savana Van) 6.0L

### 9293

Inlet A: WELDED 3-BOLT FLANGE  
 Outlet A: 2.550" O.D. PIPE  
 Outlet B: 2.550" O.D. PIPE  
 Length: 48.75"



- 2000-96 8 CHEVROLET C-(2WD), K-(4WD) PICKUP 1 TON, (Inc. SILVERADO) 5.7L
- 2000-96 8 CHEVROLET C-(2WD), K-(4WD) PICKUP 3/4 TON, (Inc. SILVERADO & AVALANCHE) 5.7L
- 2000-96 8 GMC C-(2WD), K-(4WD) PICKUP 1 TON, (Inc. SIERRA) 5.7L
- 2000-96 8 GMC C-(2WD), K-(4WD) PICKUP 3/4 TON, (Inc. SIERRA) 5.7L

### 9301

Inlet A: WELDED 4-BOLT FLANGE  
 Outlet A: 2.25" O.D. PIPE  
 Length: 74.25"



- 2003-01 4 CHRYSLER VOYAGER, GRAND VOYAGER 2.4L
- 2007-01 4 DODGE CARAVAN 2.4L

### 9302

Inlet A: LOOSE 2-BOLT FLANGE W/ FEMALE FLARE  
 Inlet B: LOOSE 2-BOLT FLANGE W/ FEMALE FLARE  
 Outlet A: 2.25" O.D. PIPE  
 Length: 58.50"



- 1995-85 8 FORD F-150 PICKUP 1/2 TON 5.0L
- 1995-85 8 FORD F-250 PICKUP 3/4 TON 5.0L

# DIRECT FIT

## 9303

Inlet A: LOOSE 2-BOLT FLANGE W/ FEMALE FLARE  
 Inlet B: LOOSE 2-BOLT FLANGE W/ FEMALE FLARE  
 Outlet A: 2.25" O.D. PIPE  
 Length: 57.75"

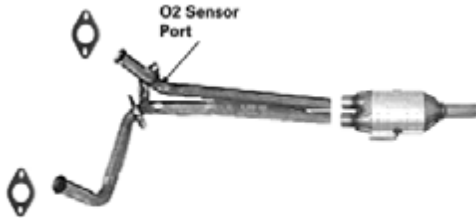

1995-91 8 FORD BRONCO 5.0L

## 9308

Inlet A: 3.02" O.D. PIPE  
 Outlet A: 2.75" O.D. PIPE  
 Length: 24.75"



1993-92 6 DODGE B-VAN 3.9L  
 1993-92 8 DODGE B-VAN All  
 1993-92 6 DODGE D-(2WD) & W-(4WD) PICKUP 1/2 & 3/4 TON 3.9L  
 1993-92 8 DODGE D-(2WD) & W-(4WD) PICKUP 1/2 & 3/4 TON 5.2L  
 1993-92 8 DODGE D-(2WD) & W-(4WD) PICKUP 1/2 & 3/4 TON 5.9L

## 9314

Inlet A: WELDED 3-BOLT FLANGE  
 Outlet A: WELDED 2-BOLT FLANGE W/ GASKET STUB  
 Length: 36.25"



2000-98 6 FORD RANGER 3.0L  
 2000-98 6 FORD RANGER 4.0L  
 1999-98 6 MAZDA B-Series PICKUP 3.0L  
 1999-98 6 MAZDA B-Series PICKUP 4.0L

## 9321

Inlet A: LOOSE 2-BOLT FLANGE W/ SPHERICAL FLARE  
 Inlet B: LOOSE 2-BOLT FLANGE W/ SPHERICAL FLARE  
 Outlet A: 2.50" O.D. PIPE  
 Length: 64.50"

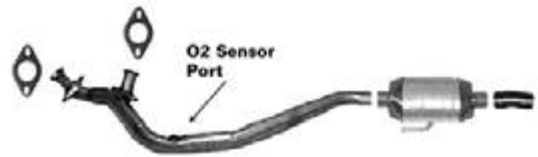

1995-87 6 FORD E-150 VAN 1/2 TON 4.9L  
 1995-87 6 FORD E-250 VAN 3/4 TON 4.9L  
 1995-87 6 FORD E-350 VAN 1 TON 4.9L

## 9327

Inlet A: 2.50" I.D. PIPE  
 Outlet A: 2.25" O.D. PIPE  
 Length: 21.50"



2000-96 4 JEEP CHEROKEE 2.5L  
 2000-96 6 JEEP CHEROKEE 4.0L  
 1998-96 8 JEEP GRAND CHEROKEE/GRAND WAGONEER 5.2L  
 1998 8 JEEP GRAND CHEROKEE/GRAND WAGONEER 5.9L  
 2000-96 6 JEEP GRAND CHEROKEE/GRAND WAGONEER 4.0L

## 9333

Inlet A: LOOSE 3-BOLT FLANGE W/ FEMALE FLARE  
 Inlet B: LOOSE 3-BOLT FLANGE W/ FEMALE FLARE  
 Outlet A: WELDED 3-BOLT FLANGE  
 Length: 48.75"

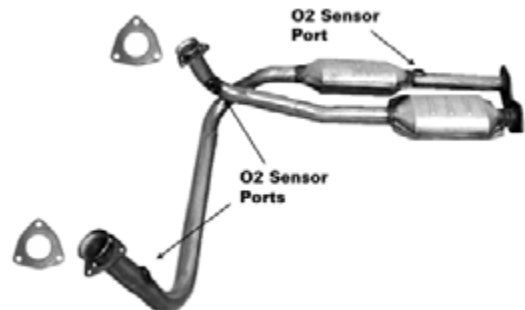

2000-99 8 CADILLAC ESCALADE 5.7L  
 1999-96 8 CHEVROLET C-(2WD), K-(4WD) PICKUP 1/2 TON, (Inc. SILVERADO & AVALANCHE) 5.7L  
 1998-96 8 CHEVROLET C-(2WD), K-(4WD) PICKUP 3/4 TON, (Inc. SILVERADO & AVALANCHE) 5.7L  
 2000-96 8 CHEVROLET SUBURBAN/TAHOE 5.7L  
 1998-96 8 GMC C-(2WD), K-(4WD) PICKUP 1/2 TON, (Inc. SIERRA) 5.7L

### 9333 (cont.)

1998-96 8 GMC C-(2WD), K-(4WD) PICKUP 3/4 TON, (Inc. SIERRA) 5.7L  
 2000-96 8 GMC SUBURBAN/YUKON 5.7L

### 9352

Inlet A: LOOSE 2-BOLT FLANGE W/ SPHERICAL FLARE  
 Inlet B: 2.50" I.D. PIPE  
 Outlet A: LOOSE 2-BOLT FLANGE W/ SPHERICAL FLARE  
 Length: 46"



2006-05 8 FORD EXPEDITION 5.4L

### 9353

Inlet A: LOOSE 2-BOLT FLANGE W/ SPHERICAL FLARE  
 Outlet A: 2.50" O.D. PIPE  
 Length: 35"



2006-05 8 FORD EXPEDITION 5.4L

### 9361

Inlet A: 2.50" I.D. PIPE  
 Outlet A: 2.25" O.D. PIPE  
 Length: 26.25"



1991-87 8 DODGE B-VAN All  
 1991-88 6 DODGE B-VAN 3.9L

### 9375

Inlet A: WELDED 2-BOLT FLANGE  
 Outlet A: 2-3/4" O.D. PIPE  
 Length: 47"



2007 8 DODGE CHARGER 6.1L

### 9390

Inlet A: LOOSE 2-BOLT FLANGE W/ FEMALE FLARE  
 Inlet B: LOOSE 2-BOLT FLANGE W/ FEMALE FLARE  
 Outlet A: 2.50" O.D. PIPE  
 Length: 53"

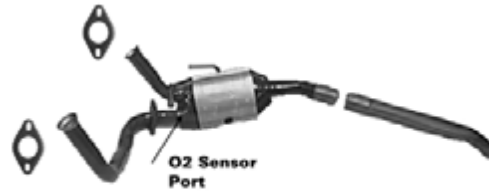

1991-86 8 FORD E-150 VAN 1/2 TON 5.0L  
 1991-86 8 FORD E-250 VAN 3/4 TON 5.0L

### 9396

Inlet A: LOOSE 2-BOLT FLANGE W/ SPHERICAL FLARE  
 Inlet B: LOOSE 2-BOLT FLANGE W/ SPHERICAL FLARE  
 Outlet A: 2.25" O.D. PIPE  
 Length: 61.50"



1996 8 FORD F-150 PICKUP 1/2 TON 5.0L  
 1996 8 FORD F-250 PICKUP 3/4 TON 5.0L

### 9403

Inlet A: WELDED 3-BOLT FLANGE  
 Outlet A: LOOSE 6-BOLT FLANGE W/ MALE BALL  
 Length: 30"

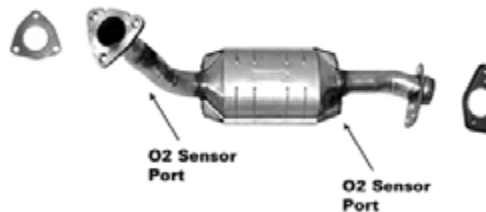

1996-94 8 BUICK ROADMASTER 5.7L  
 1995-94 8 CADILLAC COMMERCIAL CHASSIS -

# DIRECT FIT

## 9403 (cont.)

- 1996-94 8 FUNERAL COACH, LIMOUSINE 5.7L
- 1996-94 8 CADILLAC FLEETWOOD 5.7L
- 1996-94 8 CHEVROLET FULL SIZE (Inc. Impala RWD, Caprice, Belair, Police, Taxi, Station Wagon) All

## 9404

Inlet A: WELDED 3-BOLT FLANGE  
 Outlet A: LOOSE 6-BOLT FLANGE W/ MALE BALL  
 Length: 26.75"

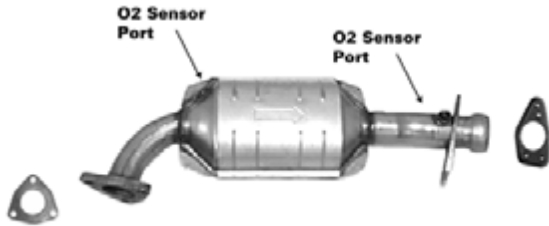

- 1996-94 8 BUICK ROADMASTER 5.7L
- 1995-94 8 CADILLAC COMMERCIAL CHASSIS - FUNERAL COACH, LIMOUSINE 5.7L
- 1996-94 8 CADILLAC FLEETWOOD 5.7L
- 1996-94 8 CHEVROLET FULL SIZE (Inc. Impala RWD, Caprice, Belair, Police, Taxi, Station Wagon) All

## 9408

Inlet A: WELDED 2-BOLT FLANGE  
 Outlet A: 2.25" I.D. PIPE  
 Length: 30.50"



- 2006-05 6 FORD ESCAPE 3.0L
- 2008-05 4 FORD ESCAPE 2.3L
- 2006-05 6 MAZDA TRIBUTE 3.0L
- 2008-05 4 MAZDA TRIBUTE 2.3L
- 2006-05 6 MERCURY MARINER 3.0L
- 2008-05 4 MERCURY MARINER 2.3L

## 9412

Inlet A: LOOSE 3-BOLT FLANGE w/ SPHERICAL FLARE  
 Inlet B: WELDED 3-BOLT FLANGE  
 Outlet A: WELDED 2-BOLT FLANGE  
 Length: 40"



- 2006-05 8 BUICK RAINIER 5.3L
- 2007-06 8 CHEVROLET TRAILBLAZER 5.3L
- 2006-05 8 GMC ENVOY 5.3L
- 2005 8 SAAB 9-7X 5.3L

## 9413

Inlet A: LOOSE 2-BOLT FLANGE W/ SPHERICAL FLARE  
 Outlet A: 2" O.D. PIPE  
 Length: 64"



- 2005-03 6 MERCEDES-BENZ ML350 3.7L

## 9414

Inlet A: LOOSE 2-BOLT FLANGE W/ SPHERICAL FLARE  
 Outlet A: 2" O.D. PIPE  
 Length: 62"



- 2005-03 6 MERCEDES-BENZ ML350 3.7L

### 9415

Inlet A: LOOSE 2-BOLT FLANGE W/ SPHERICAL FLARE  
 Inlet B: 2.50" I.D. PIPE  
 Outlet A: 2.50" O.D. PIPE  
 Length: 48.13"



2003-99 6 FORD E-150 VAN 1/2 TON 4.2L  
 2003-99 6 FORD E-250 VAN 3/4 TON 4.2L

### 9416

Inlet A: LOOSE 2-BOLT FLANGE W/ SPHERICAL FLARE  
 Outlet A: 2.50" O.D. PIPE  
 Length: 37.38"



2003-99 6 FORD E-150 VAN 1/2 TON 4.2L  
 2003-99 6 FORD E-250 VAN 3/4 TON 4.2L

### 9417

Inlet A: LOOSE 2-BOLT FLANGE W/ SPHERICAL FLARE  
 Outlet A: 2.50" O.D. PIPE  
 Length: 38.13"



1999-97 8 FORD E-150 VAN 1/2 TON 4.6L

### 9418

Inlet A: LOOSE 2-BOLT FLANGE W/ SPHERICAL FLARE  
 Inlet B: 2.50" I.D. PIPE  
 Outlet A: 2.50" O.D. PIPE  
 Length: 47.63"

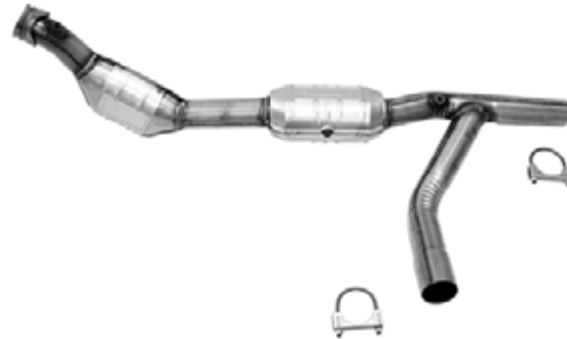

1999-97 8 FORD E-150 VAN 1/2 TON 4.6L

### 9419

Inlet A: WELDED 2-BOLT FLANGE  
 Outlet A: 2.13" O.D. PIPE  
 Length: 23.25"



2009-07 6 LEXUS RX350 3.5L  
 2013-08 6 TOYOTA HIGHLANDER 3.5L

### 9420

Inlet A: LOOSE 2-BOLT FLANGE W/ SPHERICAL FLARE  
 Inlet B: LOOSE 2-BOLT FLANGE W/ SPHERICAL FLARE  
 Outlet A: 2.50" O.D. PIPE  
 Length: 44"



2009-07 6 JEEP WRANGLER 3.8L

# DIRECT FIT

## 9422

Inlet A: LOOSE 2-BOLT FLANGE W/ SPHERICAL FLARE  
 Inlet B: 2.50" I.D. PIPE  
 Outlet A: 2.50" O.D. PIPE  
 Length: 47"



2004-97 6 FORD F-150 PICKUP 1/2 TON 4.2L

## 9423

Inlet A: LOOSE 3-BOLT FLANGE W/ SPHERICAL FLARE  
 Inlet B: WELDED 3-BOLT FLANGE  
 Outlet A: WELDED 2-BOLT FLANGE  
 Length: 40"



2004-97 6 FORD F-150 PICKUP 1/2 TON 4.2L

## 9444

Inlet A: LOOSE 3-BOLT FLANGE W/ SPHERICAL FLARE  
 Inlet B: WELDED 3-BOLT FLANGE  
 Outlet A: WELDED 2-BOLT FLANGE  
 Length: 37.25"



2005-02 8 CADILLAC ESCALADE 5.3L  
 2006-00 6 CHEVROLET C-(2WD), K-(4WD) PICKUP 1/2 TON, (Inc. SILVERADO & AVALANCHE) 4.3L  
 2006-00 8 CHEVROLET C-(2WD), K-(4WD) PICKUP 1/2 TON, (Inc. SILVERADO & AVALANCHE) 4.8L

## 9444 (cont.)

2006-00 8 CHEVROLET C-(2WD), K-(4WD) PICKUP 1/2 TON, (Inc. SILVERADO & AVALANCHE) 5.3L  
 2000 8 CHEVROLET C-(2WD), K-(4WD) PICKUP 3/4 TON, (Inc. SILVERADO & AVALANCHE) 5.3L  
 2005-00 8 CHEVROLET SUBURBAN/TAHOE 4.8L  
 2005-00 8 CHEVROLET SUBURBAN/TAHOE 5.3L  
 2006-00 6 GMC C-(2WD), K-(4WD) PICKUP 1/2 TON, (Inc. SIERRA) 4.3L  
 2006-00 8 GMC C-(2WD), K-(4WD) PICKUP 1/2 TON, (Inc. SIERRA) 4.8L  
 2006-00 8 GMC C-(2WD), K-(4WD) PICKUP 1/2 TON, (Inc. SIERRA) 5.3L  
 2000 8 GMC C-(2WD), K-(4WD) PICKUP 3/4 TON, (Inc. SIERRA) 5.3L  
 2005-01 8 GMC SUBURBAN/YUKON 4.8L  
 2005-01 8 GMC SUBURBAN/YUKON 5.3L

## 9448

Inlet A: LOOSE 2-BOLT FLANGE W/ FLARE  
 Inlet B: LOOSE 2-BOLT FLANGE W/ FLARE  
 Outlet A: WELDED 2-BOLT FLANGE  
 Length: 39"



2007-06 8 JEEP COMMANDER 5.7L  
 2010-05 8 JEEP GRAND CHEROKEE/GRAND WAGONEER 5.7L

## 9450

Inlet A: LOOSE 2-BOLT FLANGE W/ FLARE  
 Inlet B: LOOSE 2-BOLT FLANGE W/ FLARE  
 Outlet A: 3" O.D. PIPE  
 Length: 29"



2010-09 8 DODGE RAM (2WD & 4WD) PICKUP 1/2 & 3/4 TON 4.7L



### 9454

Inlet A: LOOSE 2-BOLT FLANGE W/ FLARE  
 Inlet B: LOOSE 2-BOLT FLANGE W/ FLARE  
 Outlet A: 3" O.D. PIPE  
 Length: 60"



2009	8	DODGE RAM (2WD & 4WD) PICKUP 1 TON 5.7L
2009	8	DODGE RAM (2WD & 4WD) PICKUP 1/2 & 3/4 TON 5.7L

### 9459

Inlet A: LOOSE 2-BOLT FLANGE W/ FLARE  
 Inlet B: LOOSE 2-BOLT FLANGE W/ FLARE  
 Outlet A: 3" O.D. PIPE  
 Length: 29.50"



2007-06	8	DODGE RAM (2WD & 4WD) PICKUP 1/2 & 3/4 TON 5.7L
---------	---	---

### 9455

Inlet A: LOOSE 2-BOLT FLANGE W/ FLARE  
 Inlet B: LOOSE 2-BOLT FLANGE W/ FLARE  
 Outlet A: 2.25" O.D. PIPE  
 Length: 39.25"



2008	8	DODGE RAM (2WD & 4WD) PICKUP 1/2 & 3/4 TON 5.7L
------	---	---

### 9460

Inlet A: LOOSE 2-BOLT FLANGE W/ FLARE  
 Inlet B: LOOSE 2-BOLT FLANGE W/ FLARE  
 Outlet A: WELDED 2-BOLT FLANGE  
 Length: 44"



2010-08	6	JEEP COMMANDER 3.7L
2009-07	6	JEEP GRAND CHEROKEE/GRAND WAGONEER 3.7L

### 9458

Inlet A: LOOSE 2-BOLT FLANGE W/ FLARE  
 Inlet B: LOOSE 2-BOLT FLANGE W/ FLARE  
 Outlet A: 3" O.D. PIPE  
 Length: 37.88"



2008	8	DODGE RAM (2WD & 4WD) PICKUP 1/2 & 3/4 TON 4.7L
------	---	---

### 9461

Inlet A: LOOSE 2-BOLT FLANGE W/ FLARE  
 Inlet B: LOOSE 2-BOLT FLANGE W/ FLARE  
 Outlet A: 2.75" O.D. PIPE  
 Length: 24"



2008	8	DODGE DAKOTA 4.7L
------	---	-------------------

# DIRECT FIT

## 9462

Inlet A: LOOSE 2-BOLT FLANGE W/ FLARE  
 Inlet B: LOOSE 2-BOLT FLANGE W/ FLARE  
 Outlet A: 2.98" O.D. PIPE  
 Length: 37.63"



2010-09 8 DODGE RAM (2WD & 4WD) PICKUP 1/2 & 3/4 TON 5.7L  
 2012-11 8 RAM 1500 5.7L

## 9463

Inlet A: LOOSE 2-BOLT FLANGE W/ FLARE  
 Outlet A: 2.50" O.D. PIPE  
 Length: 35.50"



1998-97 6 FORD F-150 PICKUP 1/2 TON 4.2L

## 9464

Inlet A: LOOSE 2-BOLT FLANGE W/ FLARE  
 Inlet B: 2.50" I.D. PIPE  
 Outlet A: 2.50" O.D. PIPE  
 Length: 47.50"



1998-97 6 FORD F-150 PICKUP 1/2 TON 4.2L

## 9465

Inlet A: LOOSE 2-BOLT FLANGE W/ FLARE  
 Outlet A: 2.50" O.D. PIPE  
 Length: 36"



2004-00 6 FORD F-150 PICKUP 1/2 TON 4.2L

## 9466

Inlet A: LOOSE 2-BOLT FLANGE W/ FLARE  
 Inlet B: 2.50" I.D. PIPE  
 Outlet A: 2.50" O.D. PIPE  
 Length: 46.50"



2004-00 6 FORD F-150 PICKUP 1/2 TON 4.2L

## 9467

Inlet A: WELDED 3-BOLT FLANGE  
 Outlet A: WELDED 2-BOLT FLANGE W/MALE BALL  
 Length: 30.50"



2005-04 6 FORD EXPLORER 4.0L

## 9468

Inlet A: LOOSE 2-BOLT FLANGE W/ FLARE  
 Outlet A: 2.50" O.D. PIPE  
 Length: 35"



2006-04 8 FORD F-150 PICKUP 1/2 TON 5.4L  
 2006 8 LINCOLN MARK LT 5.4L

### 9469

Inlet A: LOOSE 2-BOLT FLANGE W/ FLARE  
 Inlet B: 2.50" I.D. PIPE  
 Outlet A: 2.50" O.D. PIPE  
 Length: 49"



2006-04 8 FORD F-150 PICKUP 1/2 TON 5.4L  
 2006 8 LINCOLN MARK LT 5.4L

### 9477

Inlet A: LOOSE 2-BOLT FLANGE W/ FLARE  
 Inlet B: LOOSE 2-BOLT FLANGE W/ FLARE  
 Outlet A: WELDED 2-BOLT FLANGE W/MALE BALL  
 Length: 39"



2010-08 10 FORD F-250 PICKUP 3/4 TON 6.8L  
 2010-08 8 FORD F-250 PICKUP 3/4 TON 5.4L  
 2010-08 10 FORD F-350 PICKUP 1 TON 6.8L  
 2010-08 8 FORD F-350 PICKUP 1 TON 5.4L

### 9480

Inlet A: LOOSE 2-BOLT FLANGE W/ FLARE  
 Outlet A: 2.50" O.D. PIPE  
 Length: 35"



2005-04 8 FORD F-150 PICKUP 1/2 TON 5.4L

### 9481

Inlet A: LOOSE 2-BOLT FLANGE W/ FLARE  
 Inlet B: 2.50" I.D. PIPE  
 Outlet A: 2.50" O.D. PIPE  
 Length: 49"



2005-04 8 FORD F-150 PICKUP 1/2 TON 5.4L

### 9482

Inlet A: LOOSE 2-BOLT FLANGE W/ FLARE  
 Outlet A: 2.50" O.D. PIPE  
 Length: 35.50"



2002-01 8 FORD EXPEDITION 4.6L  
 2002-01 8 FORD F-150 PICKUP 1/2 TON 4.6L

### 9483

Inlet A: LOOSE 2-BOLT FLANGE W/ FLARE  
 Inlet B: 2.50" I.D. PIPE  
 Outlet A: 2.50" O.D. PIPE  
 Length: 46"



2002-01 8 FORD EXPEDITION 4.6L  
 2002-01 8 FORD F-150 PICKUP 1/2 TON 4.6L

### 9484

Inlet A: LOOSE 2-BOLT FLANGE W/ FLARE  
 Outlet A: 2.25" O.D. PIPE  
 Length: 39"



2000-99 6 FORD F-150 PICKUP 1/2 TON 4.2L

### 9485

Inlet A: LOOSE 2-BOLT FLANGE W/ FLARE  
 Inlet B: 2.25" I.D. PIPE  
 Outlet A: 2.25" O.D. PIPE  
 Length: 46"



2000-99 6 FORD F-150 PICKUP 1/2 TON 4.2L

# DIRECT FIT

## 9488

Inlet A: LOOSE 2-BOLT FLANGE W/ FLARE  
Outlet A: 2.5" O.D. PIPE  
Length: 37"



2008-04 8 FORD F-150 PICKUP 1/2 TON 4.6L

## 9489

Inlet A: LOOSE 2-BOLT FLANGE W/ FLARE  
Inlet B: 2.67" O.D. PIPE  
Outlet A: 2" O.D. PIPE  
Length: 44"



2008-04 8 FORD F-150 PICKUP 1/2 TON 4.6L

## 9496

Inlet A: LOOSE 2-BOLT FLANGE W/ FLARE  
Outlet A: 2.50" O.D. PIPE  
Length: 49"



2004-01 8 FORD F-150 PICKUP 1/2 TON 5.4L

## 9497

Inlet A: LOOSE 2-BOLT FLANGE W/ FLARE  
Outlet A: 2.50" O.D. PIPE  
Length: 41.63"



2004-01 8 FORD F-150 PICKUP 1/2 TON 5.4L

## 9498

Inlet A: LOOSE 2-BOLT FLANGE W/ FLARE  
Outlet A: 2.47" O.D. PIPE  
Length: 27.75"



2010-09 8 FORD F-150 PICKUP 1/2 TON 4.6L

## 9499

Inlet A: LOOSE 2-BOLT FLANGE W/ FLARE  
Inlet B: 2.49" O.D. PIPE  
Outlet A: LOOSE 2-BOLT FLANGE W/ FLARE  
Length: 44"



2010-09 8 FORD F-150 PICKUP 1/2 TON 4.6L

## 9500

Inlet A: WELDED 6-BOLT FLANGE  
Inlet B: WELDED 3-BOLT FLANGE  
Outlet A: WELDED 2-BOLT FLANGE  
Length: 19.88"



2002-01 6 NISSAN QUEST 3.3L

## 9518

Inlet A: LOOSE 3-BOLT FLANGE W/ FEMALE FLARE  
 Inlet B: LOOSE 3-BOLT FLANGE W/ FEMALE FLARE  
 Outlet A: LOOSE 4-BOLT FLANGE W/ MALE BALL  
 Length: 64.50"



1991-86 8 CHEVROLET CORVETTE 5.7L

## 9522

Inlet A: WELDED 3-BOLT FLANGE  
 Outlet A: LOOSE 2-BOLT FLANGE W/ MALE BALL  
 Length: 28.50"



1990 6 FORD BRONCO II 2.9L  
 1994-91 6 FORD EXPLORER 4.0L  
 1995-90 6 FORD RANGER 4.0L  
 1995-91 6 FORD RANGER 3.0L  
 1995-94 6 MAZDA B-Series PICKUP 3.0L  
 1995-94 6 MAZDA B-Series PICKUP 4.0L  
 1994-91 6 MAZDA NAVAJO 4.0L

## 9523

Inlet A: WELDED 3-BOLT FLANGE  
 Outlet A: LOOSE 2-BOLT FLANGE W/ FLAT FLARE  
 Length: 28.50"



1989-88 6 FORD BRONCO II 2.9L  
 1988 6 FORD RANGER 2.9L

## 9525

Inlet A: LOOSE 2-BOLT FLANGE W/ FLARE  
 Outlet A: 2" O.D. PIPE  
 Length: 28.75"



2014-11 6 FORD F-150 PICKUP 1/2 TON 3.7L

## 9526

Inlet A: LOOSE 2-BOLT FLANGE W/ FLARE  
 Inlet B: 2" I.D. PIPE  
 Outlet A: LOOSE 2-BOLT FLANGE W/ FLARE  
 Length: 49.50"



2014-11 6 FORD F-150 PICKUP 1/2 TON 3.7L

## 9527

Inlet A: LOOSE 2-BOLT FLANGE W/ FLARE  
 Outlet A: 2.50" O.D. PIPE  
 Length: 36.25"



2008-06 8 FORD F-150 PICKUP 1/2 TON 4.6L

## 9528

Inlet A: LOOSE 2-BOLT FLANGE W/ FLARE  
 Inlet B: 2.50" I.D. PIPE  
 Outlet A: 2.50" O.D. PIPE  
 Length: 49.50"



2008-06 8 FORD F-150 PICKUP 1/2 TON 4.6L

# DIRECT FIT

## 9529

Inlet A: 2.50" I.D. PIPE  
 Outlet A: 2.50" O.D. PIPE  
 Length: 27.50"



- 1992 6 CHEVROLET ASTRO VAN 4.3L
- 1986 8 CHEVROLET C-(2WD), K-(4WD) PICKUP 1 TON, (Inc. SILVERADO) 5.7L
- 1993-88 6 CHEVROLET C-(2WD), K-(4WD) PICKUP 1/2 TON, (Inc. SILVERADO & AVALANCHE) 4.3L
- 1993-88 8 CHEVROLET C-(2WD), K-(4WD) PICKUP 1/2 TON, (Inc. SILVERADO & AVALANCHE) 5.0L
- 1993-88 6 CHEVROLET C-(2WD), K-(4WD) PICKUP 3/4 TON, (Inc. SILVERADO & AVALANCHE) 4.3L
- 1993-88 8 CHEVROLET C-(2WD), K-(4WD) PICKUP 3/4 TON, (Inc. SILVERADO & AVALANCHE) 5.0L
- 1987 8 CHEVROLET R-(2WD), V-(4WD) PICKUP 5.0L
- 1986 8 GMC C-(2WD), K-(4WD) PICKUP 1 TON, (Inc. SIERRA) 5.7L
- 1993-88 6 GMC C-(2WD), K-(4WD) PICKUP 1/2 TON, (Inc. SIERRA) 4.3L
- 1993-88 8 GMC C-(2WD), K-(4WD) PICKUP 1/2 TON, (Inc. SIERRA) 5.0L
- 1993-88 6 GMC C-(2WD), K-(4WD) PICKUP 3/4 TON, (Inc. SIERRA) 4.3L
- 1993-88 8 GMC C-(2WD), K-(4WD) PICKUP 3/4 TON, (Inc. SIERRA) 5.0L
- 1992 6 GMC SAFARI VAN 4.3L

## 9530

Inlet A: WELDED 2-BOLT FLANGE W/ FEMALE FLARE  
 Outlet A: 2.25" O.D. PIPE  
 Length: 20"



- 2012-09 6 FORD ESCAPE 3.0L
- 2011-09 6 MERCURY MARINER 3.0L

## 9531

Inlet A: 2.50" I.D. PIPE  
 Outlet A: 2.50" O.D. PIPE  
 Length: 47.50"



- 1990-86 8 DODGE D-(2WD) & W-(4WD) PICKUP 1/2 & 3/4 TON 5.2L

## 9532

Inlet A: LOOSE 2-BOLT FLANGE W/ FLARE  
 Outlet A: 2.46" O.D. PIPE  
 Length: 28.50"



- 2014-11 8 FORD F-150 PICKUP 1/2 TON 5.0L

## 9533

Inlet A: LOOSE 2-BOLT FLANGE W/ FLARE  
 Outlet A: LOOSE 2-BOLT FLANGE W/ FLARE  
 Length: 44.13"



- 2014-11 8 FORD F-150 PICKUP 1/2 TON 5.0L

## 9534

Inlet A: WELDED 2-BOLT FLANGE W/GASKET STUB  
 Inlet B: WELDED 2-BOLT FLANGE  
 Outlet A: WELDED 2-BOLT FLANGE W/GASKET STUB  
 Length: 36"



- 2011-05 6 TOYOTA TACOMA 4.0L

## 9535

Inlet A: WELDED 2-BOLT FLANGE W/GASKET STUB  
 Outlet A: WELDED 2-BOLT FLANGE  
 Length: 23.50"



- 2011-05 6 TOYOTA TACOMA 4.0L

### 9536

Inlet A: WELDED 4-BOLT FLANGE  
 Outlet A: 2.38" O.D. PIPE  
 Length: 39"



2010 5 VOLKSWAGEN GOLF 2.5L  
 2010-05 5 VOLKSWAGEN JETTA 2.5L  
 2009-06 5 VOLKSWAGEN RABBIT 2.5L

### 9537

Inlet A: WELDED 3-BOLT FLANGE  
 Outlet A: WELDED 2-BOLT FLANGE  
 Length: 37"



2002-98 8 LEXUS LX470 4.7L  
 2002-98 8 TOYOTA LAND CRUISER 4.7L

### 9538

Inlet A: LOOSE 2-BOLT FLANGE W/ FLARE  
 Outlet A: 2" O.D. PIPE  
 Length: 34.25"



2006 8 LAND ROVER RANGE ROVER 4.2L  
 2006 8 LAND ROVER RANGE ROVER 4.4L

### 9539

Inlet A: LOOSE 2-BOLT FLANGE W/ FLARE  
 Outlet A: 2" O.D. PIPE  
 Length: 35.50"



2006 8 LAND ROVER RANGE ROVER 4.2L  
 2006 8 LAND ROVER RANGE ROVER 4.4L

### 9540

Inlet A: LOOSE 2-BOLT FLANGE W/ FLARE  
 Outlet A: 2.11" O.D. PIPE  
 Length: 26.50"



2006-04 6 JAGUAR VANDEN PLAS 4.2L  
 2006-04 6 JAGUAR XJ8 4.2L

### 9541

Inlet A: LOOSE 2-BOLT FLANGE W/ FLARE  
 Outlet A: 2.11" O.D. PIPE  
 Length: 26.50"



2006-04 6 JAGUAR VANDEN PLAS 4.2L  
 2006-04 6 JAGUAR XJ8 4.2L

### 9542

Inlet A: WELDED 4-BOLT FLANGE  
 Outlet A: 2.50" O.D. PIPE  
 Outlet B: 2.50" O.D. PIPE  
 Length: 44.75"



1999-97 8 CHEVROLET P30, P30 SERIES, P30 VAN 5.7L

### 9543

Inlet A: WELDED 3-BOLT FLANGE  
 Outlet A: 2.57" O.D. PIPE  
 Outlet B: 2.57" O.D. PIPE  
 Length: 35"



2000-96 8 CHEVROLET C-(2WD), K-(4WD) PICKUP 1 TON, (Inc. SILVERADO) 7.4L  
 2000-96 8 GMC C-(2WD), K-(4WD) PICKUP 1 TON, (Inc. SIERRA) 7.4L

# DIRECT FIT

## 9544

Inlet A: WELDED 3-BOLT FLANGE  
Inlet B: LOOSE 3-BOLT FLANGE W/ FLARE  
Outlet A: WELDED 2-BOLT FLANGE  
Length: 39"



- 2007-06 8 BUICK RAINIER 5.3L
- 2008-06 8 CHEVROLET TRAILBLAZER 5.3L
- 2009-06 8 CHEVROLET TRAILBLAZER 6.0L
- 2009-06 8 GMC ENVOY 5.3L
- 2006 8 ISUZU ASCENDER 5.3L
- 2009-06 8 SAAB 9-7X 5.3L
- 2009-08 8 SAAB 9-7X 6.0L

## 9545

Inlet A: WELDED 3-BOLT FLANGE  
Inlet B: LOOSE 3-BOLT FLANGE W/ FLARE  
Outlet A: WELDED 2-BOLT FLANGE  
Length: 34"



- 2013-11 8 CHEVROLET C-(2WD), K-(4WD) PICKUP 1 TON, (Inc. SILVERADO) 6.0L
- 2013-11 8 CHEVROLET C-(2WD), K-(4WD) PICKUP 3/4 TON, (Inc. SILVERADO & AVALANCHE) 6.0L
- 2013-11 8 GMC C-(2WD), K-(4WD) PICKUP 1 TON, (Inc. SIERRA) 6.0L
- 2013-11 8 GMC C-(2WD), K-(4WD) PICKUP 3/4 TON, (Inc. SIERRA) 6.0L

## 9546

Inlet A: LOOSE 3-BOLT FLANGE W/ FLARE  
Outlet A: WELDED 2-BOLT FLANGE  
Length: 47"



- 2009-08 6 CHEVROLET TRAILBLAZER 4.2L
- 2009-08 6 GMC ENVOY 4.2L
- 2009-08 6 SAAB 9-7X 4.2L

## 9547

Inlet A: WELDED 2-BOLT FLANGE  
Outlet A: WELDED 2-BOLT FLANGE W/GASKET STUB  
Length: 16.75"



- 2009-08 8 PONTIAC G8 6.0L

## 9548

Inlet A: WELDED 2-BOLT FLANGE  
Outlet A: WELDED 2-BOLT FLANGE W/GASKET STUB  
Length: 16.75"



- 2009-08 8 PONTIAC G8 6.0L

## 9549

Inlet A: WELDED 3-BOLT FLANGE  
Outlet A: 2.48" O.D. PIPE  
Length: 45"



- 2012-09 8 CHEVROLET COLORADO 5.3L
- 2012-09 8 GMC CANYON 5.3L
- 2010-08 8 HUMMER H3 5.3L

## 9550

Inlet A: LOOSE 3-BOLT FLANGE W/ FLARE  
Outlet A: WELDED 2-BOLT FLANGE W/GASKET STUB  
Length: 51.13"



- 2012-09 8 CHEVROLET COLORADO 5.3L
- 2012-09 8 GMC CANYON 5.3L
- 2010-08 8 HUMMER H3 5.3L



### 9551

Inlet A: LOOSE 2-BOLT FLANGE W/ FLARE  
 Outlet A: 2.47" O.D. PIPE  
 Length: 27"



2010-09 8 FORD F-150 PICKUP 1/2 TON 4.6L

### 9552

Inlet A: LOOSE 2-BOLT FLANGE W/ SPHERICAL FLARE  
 Inlet B: 2.50" I.D. PIPE  
 Outlet A: LOOSE 2-BOLT FLANGE  
 Length: 44.25"

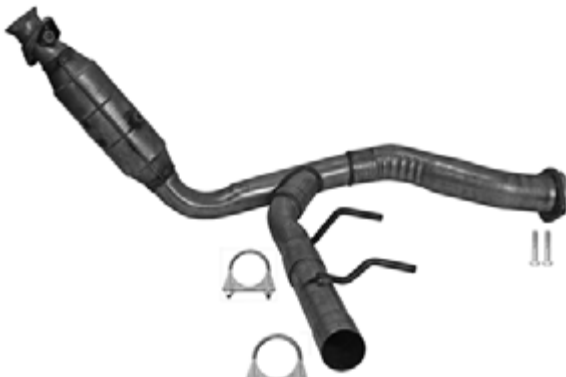

2010-09 8 FORD F-150 PICKUP 1/2 TON 4.6L

### 9594

Inlet A: LOOSE 3-BOLT FLANGE W/ FEMALE FLARE  
 Inlet B: LOOSE 3-BOLT FLANGE W/ FEMALE FLARE  
 Outlet A: 3" O.D. PIPE  
 Length: 46.50"

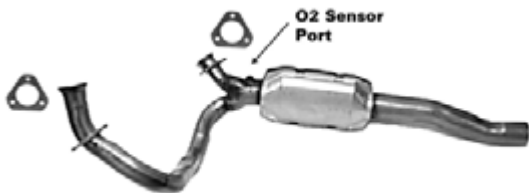

1995-94 6 CHEVROLET ASTRO VAN 4.3L  
 1995-94 6 GMC SAFARI VAN 4.3L

### 9604

Inlet A: (4) WELDED 2-BOLT FLANGES  
 Outlet A: LOOSE 2-BOLT FLANGE W/ 2.25" MALE BALL  
 Length: 28"



1996-93 8 LINCOLN MARK Series 4.6L

### 9613

Inlet A: LOOSE 2-BOLT FLANGE W/ FEMALE FLARE  
 Outlet A: 2.50" O.D. PIPE  
 Length: 38.75"



1999-97 6 FORD E-150 VAN 1/2 TON 4.2L

1999-97 6 FORD E-250 VAN 3/4 TON 4.2L

### 9614

Inlet A: LOOSE 2-BOLT FLANGE W/ FEMALE FLARE  
 Inlet B: 2.50" I.D. PIPE  
 Outlet A: 2.50" O.D. PIPE  
 Length: 49"



1999-97 6 FORD E-150 VAN 1/2 TON 4.2L

1999-97 6 FORD E-250 VAN 3/4 TON 4.2L

# DIRECT FIT

## 9615

Inlet A: WELDED 3-BOLT FLANGE  
 Inlet B: WELDED 3-BOLT FLANGE  
 Outlet A: 1.89" O.D. PIPE  
 Outlet B: LOOSE 2-BOLT FLANGE W/ 45 DEGREE FLARE  
 Length: 79.75"

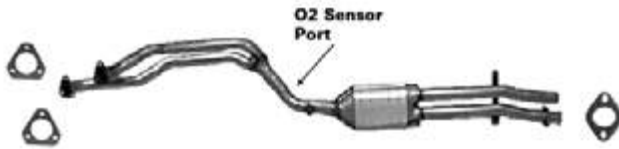

- 1995-92 6 BMW 325 2.5L
- 1998-96 6 BMW 328 2.8L
- 1998-96 6 BMW M3 3.2L

## 9616

Inlet A: LOOSE 3-BOLT FLANGE W/ 45 DEGREE FLARE  
 Inlet B: LOOSE 3-BOLT FLANGE W/ 45 DEGREE FLARE  
 Outlet A: 3" O.D. PIPE  
 Length: 41.75"

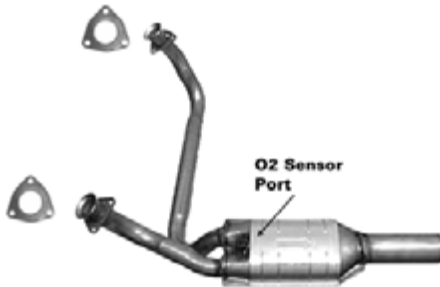

- 1995 6 CHEVROLET G -VAN 1/2 & 3/4 TON (Inc. Express Van) 4.3L
- 1995 8 CHEVROLET G -VAN 1/2 & 3/4 TON (Inc. Express Van) 5.0L
- 1995 8 CHEVROLET G -VAN 1/2 & 3/4 TON (Inc. Express Van) 5.7L
- 1995 6 GMC G -VAN 1/2 & 3/4 TON (Inc. Savana Van) 4.3L
- 1995 8 GMC G -VAN 1/2 & 3/4 TON (Inc. Savana Van) 5.0L
- 1995 8 GMC G -VAN 1/2 & 3/4 TON (Inc. Savana Van) 5.7L

## 9618

Inlet A: 3" I.D. PIPE  
 Outlet A: 2.75" O.D. PIPE  
 Length: 59.25"



- 1993-92 6 DODGE DAKOTA 3.9L
- 1993-92 8 DODGE DAKOTA 5.2L

## 9629

Inlet A: WELDED 2-BOLT FLANGE W/ GASKET STUB  
 Outlet A: WELDED 2-BOLT FLANGE W/ GASKET STUB  
 Length: 32"



- 2006-05 6 TOYOTA TUNDRA 4.0L

## 9642

Inlet A: LOOSE 2-BOLT FLANGE  
 Inlet B: WELDED 2-BOLT FLANGE  
 Outlet A: WELDED 2-BOLT FLANGE  
 Length: 34"



- 2010-07 8 CADILLAC ESCALADE 6.2L
- 2010-09 8 CHEVROLET C-(2WD), K-(4WD) PICKUP 1/2 TON, (Inc. SILVERADO & AVALANCHE) 6.2L
- 2010-09 8 GMC C-(2WD), K-(4WD) PICKUP 1/2 TON, (Inc. SIERRA) 6.2L

## 9647

Inlet A: LOOSE 2-BOLT FLANGE W/ FEMALE FLARE  
 Inlet B: LOOSE 2-BOLT FLANGE W/ FEMALE FLARE  
 Outlet A: 2.50" O.D. PIPE  
 Length: 57.25"

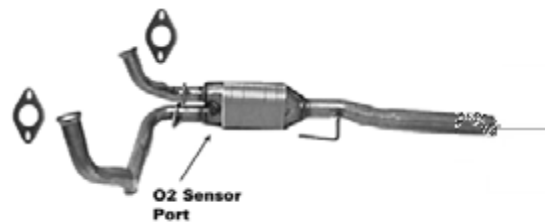

- 1995-94 6 DODGE RAM (2WD & 4WD) PICKUP 1/2 & 3/4 TON 3.9L
- 1995-94 8 DODGE RAM (2WD & 4WD) PICKUP 1/2 & 3/4 TON 5.2L
- 1995-94 8 DODGE RAM (2WD & 4WD) PICKUP 1/2 & 3/4 TON 5.9L

### 9648

Inlet A: LOOSE 3-BOLT FLANGE W/ 45 DEGREE FLARE  
 Inlet B: LOOSE 3-BOLT FLANGE W/ 45 DEGREE FLARE  
 Outlet A: LOOSE 2-BOLT FLANGE W/ MALE BALL  
 Length: 46"



1994	8	CHEVROLET BLAZER FULL SIZE 5.7L
1995-94	6	CHEVROLET C-(2WD), K-(4WD) PICKUP 1/2 TON, (Inc. SILVERADO & AVALANCHE) 4.3L
1995-94	8	CHEVROLET C-(2WD), K-(4WD) PICKUP 1/2 TON, (Inc. SILVERADO & AVALANCHE) 5.0L
1995-94	8	CHEVROLET C-(2WD), K-(4WD) PICKUP 1/2 TON, (Inc. SILVERADO & AVALANCHE) 5.7L
1995-94	6	CHEVROLET C-(2WD), K-(4WD) PICKUP 3/4 TON, (Inc. SILVERADO & AVALANCHE) 4.3L
1995-94	8	CHEVROLET C-(2WD), K-(4WD) PICKUP 3/4 TON, (Inc. SILVERADO & AVALANCHE) 5.0L
1995-94	8	CHEVROLET C-(2WD), K-(4WD) PICKUP 3/4 TON, (Inc. SILVERADO & AVALANCHE) 5.7L
1995-94	8	CHEVROLET SUBURBAN/TAHOE 5.7L
1995-94	6	GMC C-(2WD), K-(4WD) PICKUP 1/2 TON, (Inc. SIERRA) 4.3L
1995-94	8	GMC C-(2WD), K-(4WD) PICKUP 1/2 TON, (Inc. SIERRA) 5.0L
1995-94	8	GMC C-(2WD), K-(4WD) PICKUP 1/2 TON, (Inc. SIERRA) 5.7L
1995-94	6	GMC C-(2WD), K-(4WD) PICKUP 3/4 TON, (Inc. SIERRA) 4.3L
1995-94	8	GMC C-(2WD), K-(4WD) PICKUP 3/4 TON, (Inc. SIERRA) 5.0L
1995-94	8	GMC C-(2WD), K-(4WD) PICKUP 3/4 TON, (Inc. SIERRA) 5.7L
1995-94	8	GMC SUBURBAN/YUKON 5.7L

### 9649

Inlet A: LOOSE 3-BOLT FLANGE W/ 45 DEGREE FLARE  
 Inlet B: LOOSE 3-BOLT FLANGE W/ 45 DEGREE FLARE  
 Outlet A: WELDED 3-BOLT FLANGE  
 Length: 69.25"

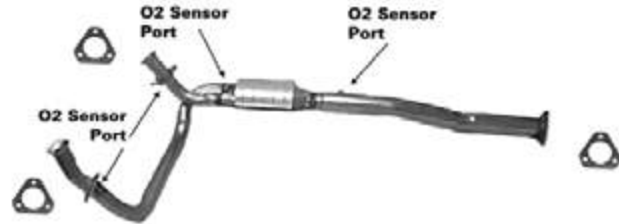

1999-96	6	CHEVROLET G -VAN 1/2 & 3/4 TON (Inc. Express Van) 4.3L
1999-96	8	CHEVROLET G -VAN 1/2 & 3/4 TON (Inc. Express Van) 5.0L
1999-96	8	CHEVROLET G -VAN 1/2 & 3/4 TON (Inc. Express Van) 5.7L
1999-96	6	GMC G -VAN 1/2 & 3/4 TON (Inc. Savana Van) 4.3L
1999-96	8	GMC G -VAN 1/2 & 3/4 TON (Inc. Savana Van) 5.0L
1999-96	8	GMC G -VAN 1/2 & 3/4 TON (Inc. Savana Van) 5.7L

### 9650

Inlet A: LOOSE 2-BOLT FLANGE W/ 2.25" FEMALE FLARE  
 Inlet B: LOOSE 2-BOLT FLANGE W/ 2-1/2" FEMALE FLARE  
 Outlet A: 2.25" O.D. PIPE  
 Length: 57"



1995-88	8	FORD F-150 PICKUP 1/2 TON 5.8L
1995-88	8	FORD F-250 PICKUP 3/4 TON 5.8L

# DIRECT FIT

## 9651

Inlet A: LOOSE 2-BOLT FLANGE W/ FEMALE FLARE  
 Inlet B: LOOSE 2-BOLT FLANGE W/ FEMALE FLARE  
 Outlet A: 2.25" O.D. PIPE  
 Length: 69.75"

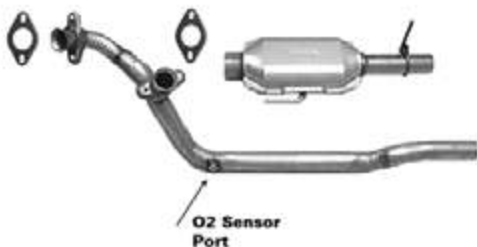

- 1990-87 6 FORD BRONCO 4.9L
- 1995-87 6 FORD F-150 PICKUP 1/2 TON 4.9L
- 1995-87 6 FORD F-250 PICKUP 3/4 TON 4.9L
- 1995-87 6 FORD F-350 PICKUP 1 TON 4.9L

## 9666

Inlet A: LOOSE 2-BOLT FLANGE W/ FEMALE FLARE  
 Inlet B: LOOSE 2-BOLT FLANGE W/ FEMALE FLARE  
 Outlet A: 2.50" O.D. PIPE  
 Length: 57.25"



- 1999-96 8 DODGE RAM (2WD & 4WD) PICKUP 1 TON 5.9L
- 1999-96 6 DODGE RAM (2WD & 4WD) PICKUP 1/2 & 3/4 TON 3.9L
- 1999-96 8 DODGE RAM (2WD & 4WD) PICKUP 1/2 & 3/4 TON 5.2L
- 1999-96 8 DODGE RAM (2WD & 4WD) PICKUP 1/2 & 3/4 TON 5.9L

## 9703

Inlet A: LOOSE 3-BOLT FLANGE W/ 45 DEGREE FLARE  
 Inlet B: LOOSE 3-BOLT FLANGE W/ 45 DEGREE FLARE  
 Outlet A: WELDED 3-BOLT FLANGE  
 Length: 49"

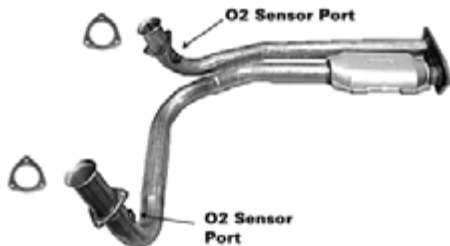

- 2000-96 8 CHEVROLET C-(2WD), K-(4WD) PICKUP 1

## 9703 (cont.)

- 2000-96 8 TON, (Inc. SILVERADO) 7.4L
- 2000-96 8 CHEVROLET C-(2WD), K-(4WD) PICKUP 3/4 TON, (Inc. SILVERADO & AVALANCHE) 7.4L
- 1999-96 8 CHEVROLET SUBURBAN/TAHOE 7.4L
- 2000-96 8 GMC C-(2WD), K-(4WD) PICKUP 1 TON, (Inc. SIERRA) 7.4L
- 2000-96 8 GMC C-(2WD), K-(4WD) PICKUP 3/4 TON, (Inc. SIERRA) 7.4L
- 1999-96 8 GMC SUBURBAN/YUKON 7.4L

## 9704

Inlet A: LOOSE 2-BOLT FLANGE W/ 2.25" FEMALE FLARE  
 Inlet B: LOOSE 2-BOLT FLANGE W/ 2" FEMALE FLARE  
 Outlet A: 2.25" O.D. PIPE  
 Length: 52.50"

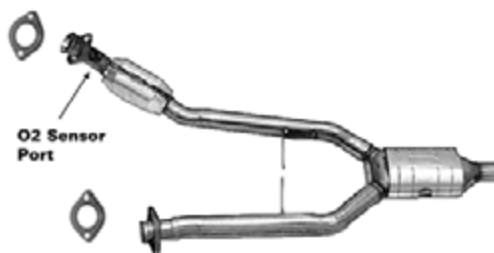

- 1998-93 8 LINCOLN MARK Series 4.6L

## 9705

Inlet A: 2.50" O.D. PIPE  
 Outlet A: 2.50" O.D. PIPE  
 Length: 57"



- 1991-90 6 DODGE DAKOTA 3.9L

## 9707

Inlet A: WELDED 3-BOLT FLANGE  
 Inlet B: WELDED 3-BOLT FLANGE  
 Outlet A: LOOSE 2-BOLT FLANGE W/ SPECIAL MALE BALL  
 Length: 49.75"



- 1998-96 8 LAND ROVER DISCOVERY 4.0L

### 9708

Inlet A: 2.50" I.D. PIPE  
 Outlet A: WELDED 3-BOLT FLANGE W/ GASKET STUB  
 Length: 23.25"

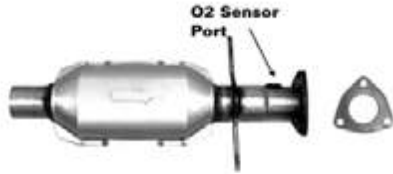

- 1995 6 CHEVROLET S-Series (2WD), T-Series (4WD) PICKUP 4.3L
- 1995 6 GMC S-Series (2WD), T-Series (4WD) PICKUP (SONOMA) 4.3L

### 9709

Inlet A: WELDED 3-BOLT FLANGE  
 Inlet B: WELDED 3-BOLT FLANGE  
 Outlet A: LOOSE 2-BOLT FLANGE W/ SPECIAL MALE BALL  
 Length: 50.25"



- 2002-99 8 LAND ROVER DISCOVERY 4.0L
- 2004-03 8 LAND ROVER DISCOVERY 4.6L

### 9710

Inlet A: WELDED 3-BOLT FLANGE  
 Outlet A: WELDED 3-BOLT FLANGE  
 Length: 25.25"



- 1997-96 6 CHEVROLET S-Series (2WD), T-Series (4WD) PICKUP 4.3L
- 1997-96 6 GMC S-Series (2WD), T-Series (4WD) PICKUP (SONOMA) 4.3L
- 1997 6 ISUZU PICKUP 4.3L

### 9712

Inlet A: WELDED 4-BOLT FLANGE  
 Outlet A: WELDED 2-BOLT FLANGE  
 Length: 24"



- 2005-02 6 LAND ROVER FREELANDER 2.5L

### 9713

Inlet A: WELDED 2-BOLT FLANGE W/ GASKET STUB  
 Outlet A: 1.770" O.D. PIPE  
 Length: 32.50"



- 2005-02 6 LAND ROVER FREELANDER 2.5L

### 9715

Inlet A: LOOSE 2-BOLT FLANGE W/ FEMALE FLARE  
 Inlet B: LOOSE 2-BOLT FLANGE W/ FEMALE FLARE  
 Outlet A: 2.50" O.D. PIPE  
 Length: 53.25"

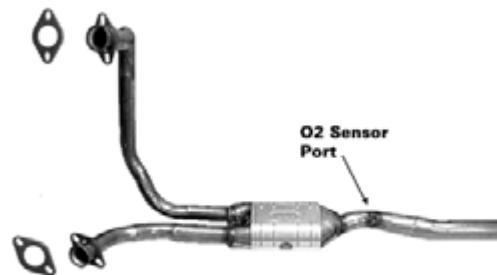

- 1997-95 6 DODGE B-VAN 3.9L
- 1997-95 8 DODGE B-VAN 5.2L
- 1997-95 8 DODGE B-VAN 5.9L

### 9716

Inlet A: 2.25" I.D. PIPE  
 Outlet A: 2.25" O.D. PIPE  
 Length: 23.88"

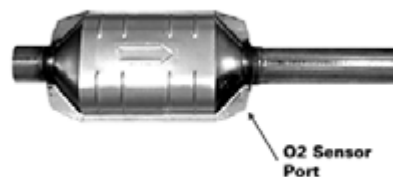

- 1995-93 6 JEEP WRANGLER 4.0L

# DIRECT FIT

## 9717

Inlet A: LOOSE 2-BOLT FLANGE W/ FEMALE FLARE  
 Inlet B: LOOSE 2-BOLT FLANGE W/ FEMALE FLARE  
 Outlet A: 1.965" O.D. PIPE  
 Outlet B: LOOSE 2-BOLT FLANGE W/ 45 DEGREE FLARE  
 Length: 75.63"



1989-87 6 MERCEDES-BENZ 260 2.6L  
 1993-86 6 MERCEDES-BENZ 300 3.0L

## 9720

Inlet A: LOOSE 3-BOLT FLANGE W/ 45 DEGREE FLARE  
 Inlet B: LOOSE 3-BOLT FLANGE W/ 45 DEGREE FLARE  
 Outlet A: WELDED 2-BOLT FLANGE  
 Length: 48.63"

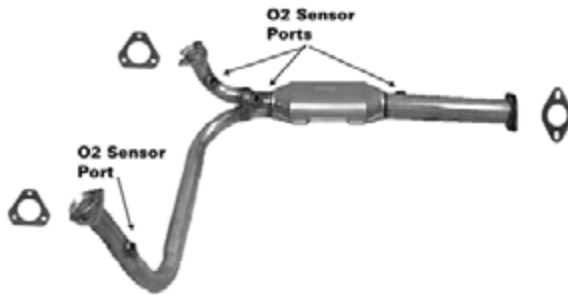

1998-96 6 CHEVROLET C-(2WD), K-(4WD) PICKUP 1/2 TON, (Inc. SILVERADO & AVALANCHE) 4.3L  
 1999-96 8 CHEVROLET C-(2WD), K-(4WD) PICKUP 1/2 TON, (Inc. SILVERADO & AVALANCHE) 5.0L  
 1999-96 8 CHEVROLET C-(2WD), K-(4WD) PICKUP 1/2 TON, (Inc. SILVERADO & AVALANCHE) 5.7L  
 1998-96 8 CHEVROLET C-(2WD), K-(4WD) PICKUP 3/4 TON, (Inc. SILVERADO & AVALANCHE) 5.0L  
 1998-96 6 GMC C-(2WD), K-(4WD) PICKUP 1/2 TON, (Inc. SIERRA) 4.3L  
 1998-96 8 GMC C-(2WD), K-(4WD) PICKUP 1/2 TON, (Inc. SIERRA) 5.0L  
 1998-96 8 GMC C-(2WD), K-(4WD) PICKUP 1/2 TON, (Inc. SIERRA) 5.7L  
 1998-96 8 GMC C-(2WD), K-(4WD) PICKUP 3/4 TON, (Inc. SIERRA) 5.0L

## 9869

Inlet A: LOOSE 3-BOLT FLANGE W/ FLARE  
 Inlet B: LOOSE 3-BOLT FLANGE W/ FLARE  
 Outlet A: WELDED 2-BOLT FLANGE  
 Outlet B: 3" O.D. PIPE  
 Length: 58"



2009-03 8 CHEVROLET C4500 KODIAK 8.1L  
 2009-03 8 GMC C4500 TOPKICK 8.1L

## 9870

Inlet A: WELDED 2-BOLT FLANGE  
 Inlet B: 3" I.D. PIPE  
 Outlet A: 3" O.D. PIPE  
 Length: 67.50"



2009-03 8 CHEVROLET C4500 KODIAK 8.1L  
 2009-03 8 GMC C4500 TOPKICK 8.1L

## 9871

Inlet A: WELDED 3-BOLT FLANGE  
 Inlet B: LOOSE 3-BOLT FLANGE W/ FLARE  
 Outlet A: WELDED 2-BOLT FLANGE  
 Length: 56"



2006-05 8 CHEVROLET TRAILBLAZER EXT 5.3L  
 2006-05 8 GMC ENVOY XL 5.3L  
 2005 8 GMC ENVOY XUV 5.3L

### 9872

**Inlet A: WELDED 3-BOLT FLANGE**  
**Inlet B: LOOSE 3-BOLT FLANGE W/ FLARE**  
**Outlet A: WELDED 2-BOLT FLANGE**  
**Length: 60"**



2011-10	8	CHEVROLET G -VAN 1 TON (Inc. Express Van) 4.8L
2011-10	8	CHEVROLET G -VAN 1 TON (Inc. Express Van) 6.0L
2014-09	6	CHEVROLET G -VAN 1/2 & 3/4 TON (Inc. Express Van) 4.3L
2011-10	8	CHEVROLET G -VAN 1/2 & 3/4 TON (Inc. Express Van) 4.8L
2014-09	8	CHEVROLET G -VAN 1/2 & 3/4 TON (Inc. Express Van) 5.3L
2011-10	8	CHEVROLET G -VAN 1/2 & 3/4 TON (Inc. Express Van) 6.0L
2011-10	8	GMC G -VAN 1 TON (Inc. Savana Van) 4.8L
2011-10	8	GMC G -VAN 1 TON (Inc. Savana Van) 6.0L
2011-10	8	GMC G -VAN 1/2 & 3/4 TON (Inc. Savana Van) 4.8L
2011-10	8	GMC G -VAN 1/2 & 3/4 TON (Inc. Savana Van) 6.0L
2014-09	6	GMC G -VAN 1/2 & 3/4 TON (Inc. Savana Van) 4.3L
2014-09	8	GMC G -VAN 1/2 & 3/4 TON (Inc. Savana Van) 5.3L

### 9873

**Inlet A: WELDED 3-BOLT FLANGE**  
**Inlet B: LOOSE 3-BOLT FLANGE W/ FLARE**  
**Outlet A: WELDED 2-BOLT FLANGE**  
**Length: 53.25"**



2009-07	8	CHEVROLET C-(2WD), K-(4WD) PICKUP 1 TON, (Inc. SILVERADO) 6.0L
2009-07	8	CHEVROLET C-(2WD), K-(4WD) PICKUP 3/4 TON, (Inc. SILVERADO & AVALANCHE) 6.0L
2009-07	8	GMC C-(2WD), K-(4WD) PICKUP 1 TON, (Inc. SIERRA) 6.0L
2009-07	8	GMC C-(2WD), K-(4WD) PICKUP 3/4 TON, (Inc. SIERRA) 6.0L

### 9874

**Inlet A: WELDED 3-BOLT FLANGE**  
**Outlet A: 2.94" O.D. PIPE**  
**Length: 66"**



2010-06	8	CHEVROLET G -VAN 1 TON (Inc. Express Van) 4.8L
2010-06	8	CHEVROLET G -VAN 1 TON (Inc. Express Van) 6.0L
2010-06	8	CHEVROLET G -VAN 1/2 & 3/4 TON (Inc. Express Van) 4.8L
2010-06	8	CHEVROLET G -VAN 1/2 & 3/4 TON (Inc. Express Van) 6.0L
2010-06	8	GMC G -VAN 1 TON (Inc. Savana Van) 4.8L
2010-06	8	GMC G -VAN 1 TON (Inc. Savana Van) 6.0L
2010-06	8	GMC G -VAN 1/2 & 3/4 TON (Inc. Savana Van) 4.8L
2010-06	8	GMC G -VAN 1/2 & 3/4 TON (Inc. Savana Van) 6.0L

### 9875

**Inlet A: WELDED 3-BOLT FLANGE**  
**Outlet A: WELDED 3-BOLT FLANGE**  
**Length: 57.75"**



2010-06	8	CHEVROLET G -VAN 1 TON (Inc. Express Van) 4.8L
2010-06	8	CHEVROLET G -VAN 1 TON (Inc. Express Van) 6.0L
2010-06	8	CHEVROLET G -VAN 1/2 & 3/4 TON (Inc. Express Van) 4.8L
2010-06	8	CHEVROLET G -VAN 1/2 & 3/4 TON (Inc. Express Van) 6.0L
2010-06	8	GMC G -VAN 1 TON (Inc. Savana Van) 4.8L
2010-06	8	GMC G -VAN 1 TON (Inc. Savana Van) 6.0L
2010-06	8	GMC G -VAN 1/2 & 3/4 TON (Inc. Savana Van) 4.8L
2010-06	8	GMC G -VAN 1/2 & 3/4 TON (Inc. Savana Van) 6.0L

# DIRECT FIT

## 9876

**Inlet A: WELDED 3-BOLT FLANGE**  
**Outlet A: 2.94" O.D. PIPE**  
**Length: 62"**



- 2013-08 8 CHEVROLET G -VAN 1 TON (Inc. Express Van) 4.8L
- 2013-08 8 CHEVROLET G -VAN 1 TON (Inc. Express Van) 6.0L
- 2013-08 8 CHEVROLET G -VAN 1/2 & 3/4 TON (Inc. Express Van) 4.8L
- 2013-08 8 CHEVROLET G -VAN 1/2 & 3/4 TON (Inc. Express Van) 6.0L
- 2013-08 8 GMC G -VAN 1 TON (Inc. Savana Van) 4.8L
- 2013-08 8 GMC G -VAN 1 TON (Inc. Savana Van) 6.0L
- 2013-08 8 GMC G -VAN 1/2 & 3/4 TON (Inc. Savana Van) 4.8L
- 2013-08 8 GMC G -VAN 1/2 & 3/4 TON (Inc. Savana Van) 6.0L

## 9877

**Inlet A: WELDED 3-BOLT FLANGE**  
**Outlet A: 3" O.D. PIPE**  
**Length: 56"**



- 2006-03 8 CHEVROLET C-(2WD), K-(4WD) PICKUP 1 TON, (Inc. SILVERADO) 6.0L
- 2006-03 8 CHEVROLET C-(2WD), K-(4WD) PICKUP 1 TON, (Inc. SILVERADO) 8.1L
- 2006-03 8 CHEVROLET C-(2WD), K-(4WD) PICKUP 3/4 TON, (Inc. SILVERADO & AVALANCHE) 6.0L
- 2006-03 8 GMC C-(2WD), K-(4WD) PICKUP 1 TON, (Inc. SIERRA) 6.0L
- 2006-03 8 GMC C-(2WD), K-(4WD) PICKUP 1 TON, (Inc. SIERRA) 8.1L
- 2006-03 8 GMC C-(2WD), K-(4WD) PICKUP 3/4 TON, (Inc. SIERRA) 6.0L

## 9878

**Inlet A: WELDED 3-BOLT FLANGE**  
**Outlet A: 3" O.D. PIPE**  
**Length: 88"**



- 2006-03 8 CHEVROLET C-(2WD), K-(4WD) PICKUP 1 TON, (Inc. SILVERADO) 6.0L
- 2006-03 8 CHEVROLET C-(2WD), K-(4WD) PICKUP 1 TON, (Inc. SILVERADO) 8.1L
- 2006-03 8 CHEVROLET C-(2WD), K-(4WD) PICKUP 3/4 TON, (Inc. SILVERADO & AVALANCHE) 6.0L
- 2006-03 8 CHEVROLET C-(2WD), K-(4WD) PICKUP 3/4 TON, (Inc. SILVERADO & AVALANCHE) 8.1L
- 2006-03 8 GMC C-(2WD), K-(4WD) PICKUP 1 TON, (Inc. SIERRA) 6.0L
- 2006-03 8 GMC C-(2WD), K-(4WD) PICKUP 1 TON, (Inc. SIERRA) 8.1L
- 2006-03 8 GMC C-(2WD), K-(4WD) PICKUP 3/4 TON, (Inc. SIERRA) 6.0L
- 2006-03 8 GMC C-(2WD), K-(4WD) PICKUP 3/4 TON, (Inc. SIERRA) 8.1L

## 9879

**Inlet A: WELDED 3-BOLT FLANGE**  
**Inlet B: LOOSE 3-BOLT FLANGE W/ FLARE**  
**Outlet A: WELDED 2-BOLT FLANGE**  
**Length: 55"**



- 2004 8 BUICK RAINIER 5.3L
- 2004-03 8 GMC ENVOY XL 5.3L



### 9880

Inlet A: LOOSE 3-BOLT FLANGE W/ FLARE  
 Inlet B: LOOSE 3-BOLT FLANGE W/ FLARE  
 Outlet A: WELDED 2-BOLT FLANGE  
 Length: 70"



- |         |   |  |
|---------|---|--|
| 2002-00 | 8 | CHEVROLET G -VAN 1 TON (Inc. Express Van) 5.7L         |
| 2002-00 | 8 | CHEVROLET G -VAN 1/2 & 3/4 TON (Inc. Express Van) 5.7L |
| 2002-00 | 8 | GMC G -VAN 1 TON (Inc. Savana Van) 5.7L                |
| 2002-00 | 8 | GMC G -VAN 1/2 & 3/4 TON (Inc. Savana Van) 5.7L        |

### 9881

Inlet A: WELDED 3-BOLT FLANGE  
 Outlet A: WELDED 3-BOLT FLANGE  
 Length: 21.75"



- |         |   |   |
|---------|---|---|
| 1999-96 | 6 | CHEVROLET S-Series (2WD), T-Series (4WD) PICKUP 4.3L    |
| 1999-96 | 6 | GMC S-Series (2WD), T-Series (4WD) PICKUP (SONOMA) 4.3L |
| 1999-98 | 6 | ISUZU PICKUP 4.3L                                       |

### 9882

Inlet A: WELDED 3-BOLT FLANGE  
 Inlet B: WELDED 3-BOLT FLANGE  
 Outlet A: LOOSE 2-BOLT FLANGE W/MALE BALL  
 Length: 53.50"



- |         |   |                             |
|---------|---|-----------------------------|
| 2000-99 | 8 | LAND ROVER RANGE ROVER 4.0L |
| 2002-99 | 8 | LAND ROVER RANGE ROVER 4.6L |

### 9883

Inlet A: LOOSE 2-BOLT FLANGE W/ FLARE  
 Outlet A: 2.92" O.D. PIPE  
 Length: 51"



- |         |   |                          |
|---------|---|--------------------------|
| 2012-07 | 8 | MERCEDES-BENZ GL450 4.6L |
| 2012-08 | 8 | MERCEDES-BENZ GL550 5.5L |
| 2011-08 | 8 | MERCEDES-BENZ ML550 5.5L |

### 9884

Inlet A: LOOSE 2-BOLT FLANGE W/ FLARE  
 Outlet A: 2.38" O.D. PIPE  
 Length: 52.50"



- |         |   |                          |
|---------|---|--------------------------|
| 2012-07 | 8 | MERCEDES-BENZ GL450 4.6L |
| 2012-08 | 8 | MERCEDES-BENZ GL550 5.5L |
| 2011-08 | 8 | MERCEDES-BENZ ML550 5.5L |

# DIRECT FIT

## 9893

Inlet A: LOOSE 2-BOLT FLANGE W/ FLARE  
 Inlet B: LOOSE 2-BOLT FLANGE W/ FLARE  
 Outlet A: 2.50" O.D. PIPE  
 Length: 55.50"



2014-09 8 FORD E-150 VAN 1/2 TON 4.6L  
 2014-09 8 FORD E-250 VAN 3/4 TON 4.6L

## 9898

Inlet A: LOOSE 2-BOLT FLANGE W/ FLARE  
 Inlet B: LOOSE 2-BOLT FLANGE W/ FLARE  
 Outlet A: 2.50" O.D. PIPE  
 Length: 63"



2003-01 8 DODGE DURANGO 5.9L

## 9899

Inlet A: LOOSE 2-BOLT FLANGE  
 Inlet B: LOOSE 2-BOLT FLANGE  
 Outlet A: 2.50" O.D. PIPE  
 Length: 55"



2003-00 8 DODGE DAKOTA 4.7L

## 9900

Inlet A: WELDED 4-BOLT FLANGE W/ STUDS  
 Outlet A: 2.50" O.D. PIPE  
 Length: 29.25"



1993-87 8 FORD E-250 VAN 3/4 TON 7.5L

## 9900 (cont.)

1995-88 8 FORD E-250 VAN 3/4 TON 5.8L  
 1995-87 8 FORD E-350 VAN 1 TON 7.5L  
 1995-88 8 FORD E-350 VAN 1 TON 5.8L  
 1997-87 8 FORD F-250 PICKUP 3/4 TON 5.8L  
 1997-87 8 FORD F-250 PICKUP 3/4 TON 7.5L  
 1997-87 8 FORD F-350 PICKUP 1 TON 5.8L  
 1997-87 8 FORD F-350 PICKUP 1 TON 7.5L

## 9901

Inlet A: 3" I.D. PIPE  
 Outlet A: 3" O.D. PIPE  
 Length: 30"



1995-87 8 FORD F-250 PICKUP 3/4 TON 5.8L  
 1995-87 8 FORD F-250 PICKUP 3/4 TON 7.5L  
 1997-88 8 FORD F-350 PICKUP 1 TON 5.8L  
 1997-88 8 FORD F-350 PICKUP 1 TON 7.5L

## 9902

Inlet A: WELDED 4-BOLT FLANGE W/ STUDS  
 Outlet A: 3" O.D. PIPE  
 Length: 29.25"



1997-87 8 FORD F-250 PICKUP 3/4 TON 5.8L  
 1997-87 8 FORD F-250 PICKUP 3/4 TON 7.5L  
 1997-88 8 FORD F-350 PICKUP 1 TON 5.8L  
 1997-88 8 FORD F-350 PICKUP 1 TON 7.5L

## 9903

Inlet A: WELDED 3-BOLT FLANGE  
 Outlet A: 2.165" O.D. PIPE  
 Length: 19.38"



1998-96 6 VOLKSWAGEN GOLF 2.8L  
 1997-96 6 VOLKSWAGEN PASSAT 2.8L

### 9904

Inlet A: WELDED 2-BOLT FLANGE W/ GASKET STUB  
 Outlet A: LOOSE 2-BOLT FLANGE W/ FLAT FLARE  
 Length: 17.25"



1996 6 MAZDA MILLENIA 2.5L

### 9905

Inlet A: LOOSE 2-BOLT FLANGE W/ FLARE  
 Outlet A: 2.50" O.D. PIPE  
 Length: 36.50"



2006-05 8 LINCOLN NAVIGATOR 5.4L

### 9906

Inlet A: LOOSE 2-BOLT FLANGE W/ FLARE  
 Inlet B: 2.50" I.D. PIPE  
 Outlet A: LOOSE 2-BOLT FLANGE W/ FLARE  
 Length: 45"



2006-05 8 LINCOLN NAVIGATOR 5.4L

### 9907

Inlet A: LOOSE 2-BOLT FLANGE W/ FLARE  
 Inlet B: LOOSE 2-BOLT FLANGE W/ FLARE  
 Outlet A: 2.50" O.D. PIPE  
 Length: 51"



2003-00 8 DODGE B-VAN 5.9L

### 9912

Inlet A: LOOSE 3-BOLT FLANGE W/ SPHERICAL FLARE  
 Inlet B: WELDED 3-BOLT FLANGE  
 Outlet A: 2.50" OD PIPE W/ SPHERICAL BALL  
 Length: 42.75"



- 2013-09 6 CHEVROLET C-(2WD), K-(4WD) PICKUP 1/2 TON, (Inc. SILVERADO & AVALANCHE) 4.3L
- 2013-09 8 CHEVROLET C-(2WD), K-(4WD) PICKUP 1/2 TON, (Inc. SILVERADO & AVALANCHE) 4.8L
- 2013-09 8 CHEVROLET C-(2WD), K-(4WD) PICKUP 1/2 TON, (Inc. SILVERADO & AVALANCHE) 5.3L
- 2009 8 CHEVROLET SUBURBAN/TAHOE 4.8L
- 2014-09 8 CHEVROLET SUBURBAN/TAHOE 5.3L
- 2013-09 6 GMC C-(2WD), K-(4WD) PICKUP 1/2 TON, (Inc. SIERRA) 4.3L
- 2013-09 8 GMC C-(2WD), K-(4WD) PICKUP 1/2 TON, (Inc. SIERRA) 4.8L
- 2013-09 8 GMC C-(2WD), K-(4WD) PICKUP 1/2 TON, (Inc. SIERRA) 5.3L
- 2009 8 GMC SUBURBAN/YUKON 4.8L
- 2014-09 8 GMC SUBURBAN/YUKON 5.3L

# DIRECT FIT

## 9913

Inlet A: LOOSE 2-BOLT FLANGE W/ SPHERICAL FLARE  
 Inlet B: LOOSE 2-BOLT FLANGE W/ SPHERICAL FLARE  
 Outlet A: WELDED 2-BOLT FLANGE  
 Length: 50.13"



2007-05 6 JEEP LIBERTY 3.7L

## 9915

Inlet A: LOOSE 2-BOLT FLANGE W/ SPHERICAL FLARE  
 Inlet B: LOOSE 2-BOLT FLANGE W/ SPHERICAL FLARE  
 Outlet A: 2.39" O.D. PIPE  
 Length: 53"



2003-02 8 DODGE RAM (2WD & 4WD) PICKUP 1/2 & 3/4 TON 5.9L

## 9916

Inlet A: LOOSE 3-BOLT FLANGE W/ FEMALE FLARE  
 Outlet A: 3" O.D. PIPE  
 Length: 71"



2002-01 8 CHEVROLET G -VAN 1 TON (Inc. Express Van) 5.7L  
 2002-01 8 CHEVROLET G -VAN 1/2 & 3/4 TON (Inc. Express Van) 5.7L  
 2002-01 8 GMC G -VAN 1 TON (Inc. Savana Van) 5.7L  
 2002-01 8 GMC G -VAN 1/2 & 3/4 TON (Inc. Savana Van) 5.7L

## 9917

Inlet A: LOOSE 3-BOLT FLANGE W/ FEMALE FLARE  
 Outlet A: WELDED 3-BOLT FLANGE  
 Length: 61"



2002-01 8 CHEVROLET G -VAN 1 TON (Inc. Express Van) 5.7L  
 2002-01 8 CHEVROLET G -VAN 1/2 & 3/4 TON (Inc. Express Van) 5.7L  
 2002-01 8 GMC G -VAN 1 TON (Inc. Savana Van) 5.7L  
 2002-01 8 GMC G -VAN 1/2 & 3/4 TON (Inc. Savana Van) 5.7L

## 9918

Inlet A: LOOSE 2-BOLT FLANGE w/ SPHERICAL FLARE  
 Inlet B: WELDED 3-BOLT FLANGE  
 Outlet A: 3.00" I.D. PIPE  
 Length: 54"



2003 8 DODGE RAM (2WD & 4WD) PICKUP 1 TON 5.7L  
 2003 8 DODGE RAM (2WD & 4WD) PICKUP 1/2 & 3/4 TON 5.7L

## 9920

Inlet A: WELDED 2-BOLT FLANGE W/ FEMALE FLARE  
 Outlet A: WELDED 2-BOLT FLANGE W/ GASKET STUB  
 Length: 47.50"



2011-05 4 TOYOTA TACOMA 2.7L

### 9971

Inlet A: WELDED 3-BOLT FLANGE W/ GASKET STUB  
 Outlet A: WELDED 2-BOLT FLANGE W/ GASKET STUB  
 Length: 49.50"



2004-03 8 TOYOTA TUNDRA 4.7L

### 9976

Inlet A: LOOSE 3-BOLT FLANGE w/ SPHERICAL FLARE  
 Inlet B: WELDED 3-BOLT FLANGE  
 Outlet A: WELDED 2-BOLT FLANGE  
 Length: 46"



2007 8 HUMMER H2 6.0L  
 2008 8 HUMMER H2 6.2L

### 9977

Inlet A: WELDED 3-BOLT FLANGE W/ GASKET STUB  
 Outlet A: WELDED 2-BOLT FLANGE W/ GASKET STUB  
 Length: 29.75"



2004-03 8 TOYOTA TUNDRA 4.7L

### 9978

Inlet A: WELDED 2-BOLT FLANGE W/ GASKET STUB  
 Inlet B: WELDED 2-BOLT FLANGE W/ GASKET STUB  
 Outlet A: WELDED 2-BOLT FLANGE  
 Length: 43.75"



1997-96 6 LEXUS LX450 4.5L  
 1997-95 6 TOYOTA LAND CRUISER 4.5L

### 9980

Inlet A: WELDED 2-BOLT FLANGE  
 Outlet A: 3" O.D. PIPE  
 Length: 33"



2001-99 8 CHEVROLET C-(2WD), K-(4WD) PICKUP 3/4 TON, (Inc. SILVERADO & AVALANCHE) 6.0L  
 2001-99 8 GMC C-(2WD), K-(4WD) PICKUP 3/4 TON, (Inc. SIERRA) 6.0L

### 9981

Inlet A: WELDED 2-BOLT FLANGE  
 Outlet A: 2.25" I.D. PIPE  
 Length: 22.25"



2012-09 4 FORD ESCAPE 2.5L  
 2011-09 4 MAZDA TRIBUTE 2.5L  
 2011-10 4 MERCURY MARINER 2.5L

**DIRECT FIT**

**9982**

Inlet A: LOOSE 2-BOLT FLANGE W/ FEMALE FLARE  
Outlet A: 2.50" O.D. PIPE  
Length: 38"



2004-03 8 LINCOLN NAVIGATOR 5.4L

**9983**

Inlet A: LOOSE 2-BOLT FLANGE W/ FEMALE FLARE  
Inlet B: 2.50" I.D. PIPE  
Outlet A: 2.50" I.D. PIPE W/ SPHERICAL FLARE  
Length: 45"



2004-03 8 LINCOLN NAVIGATOR 5.4L

**9984**

Inlet A: LOOSE 2-BOLT FLANGE W/ FEMALE FLARE  
Outlet A: 2.50" O.D. PIPE  
Length: 27"



2014-07 8 FORD EXPEDITION 5.4L  
2010-09 8 FORD F-150 PICKUP 1/2 TON 5.4L  
2014-07 8 LINCOLN NAVIGATOR 5.4L

**9985**

Inlet A: LOOSE 2-BOLT FLANGE W/ FEMALE FLARE  
Inlet B: 2.50" I.D. PIPE  
Outlet A: LOOSE 2-BOLT FLANGE W/ FEMALE FLARE  
Length: 44"



2014-07 8 FORD EXPEDITION 5.4L  
2010-09 8 FORD F-150 PICKUP 1/2 TON 5.4L  
2014-07 8 LINCOLN NAVIGATOR 5.4L

**9986**

Inlet A: LOOSE 2-BOLT FLANGE W/ FEMALE FLARE  
Outlet A: 2.50" O.D. PIPE  
Length: 37.50"



2007-00 8 FORD E-150 VAN 1/2 TON 4.6L  
2007-03 8 FORD E-250 VAN 3/4 TON 4.6L

**9987**

Inlet A: LOOSE 2-BOLT FLANGE W/ FEMALE FLARE  
Inlet B: 2.50" I.D. PIPE  
Outlet A: 2.50" O.D. PIPE  
Length: 46.50"



2007-00 8 FORD E-150 VAN 1/2 TON 4.6L  
2007-03 8 FORD E-250 VAN 3/4 TON 4.6L

### 9988

Inlet A: WELDED 4-BOLT FLANGE  
 Outlet A: 2.57" O.D. PIPE  
 Length: 20"



- 2005-00 6 BUICK LESABRE 3.8L
- 2005-00 6 BUICK PARK AVENUE 3.8L
- 2005-00 8 CADILLAC DEVILLE 4.6L
- 2005-00 6 PONTIAC BONNEVILLE 3.8L

### 9989

Inlet A: LOOSE 2-BOLT FLANGE W/ SPHERICAL FLARE  
 Inlet B: LOOSE 2-BOLT FLANGE W/ SPHERICAL FLARE  
 Outlet A: 2.50" O.D. PIPE  
 Length: 19"



- 2007 8 CHRYSLER ASPEN 4.7L
- 2007-05 6 DODGE DURANGO 3.7L
- 2007-05 8 DODGE DURANGO 4.7L

### 9990

Inlet A: WELDED 2-BOLT FLANGE  
 Outlet A: 3" O.D. PIPE  
 Length: 25"



- 2006-04 8 CHEVROLET C-(2WD), K-(4WD) PICKUP 1 TON, (Inc. SILVERADO) 6.0L
- 2006-04 8 CHEVROLET C-(2WD), K-(4WD) PICKUP 1 TON, (Inc. SILVERADO) 8.1L
- 2006-01 8 CHEVROLET C-(2WD), K-(4WD) PICKUP 3/4 TON, (Inc. SILVERADO & AVALANCHE) 6.0L
- 2006-01 8 CHEVROLET C-(2WD), K-(4WD) PICKUP 3/4 TON, (Inc. SILVERADO & AVALANCHE) 8.1L
- 2007 8 CHEVROLET SILVERADO 2500 HD CLASSIC 6.0L
- 2007 8 CHEVROLET SILVERADO 2500 HD CLASSIC 8.1L
- 2007 8 CHEVROLET SILVERADO 3500 CLASSIC 6.0L
- 2007 8 CHEVROLET SILVERADO 3500 CLASSIC 8.1L
- 2006-01 8 GMC C-(2WD), K-(4WD) PICKUP 3/4 TON, (Inc. SIERRA) 6.0L
- 2006-01 8 GMC C-(2WD), K-(4WD) PICKUP 3/4 TON, (Inc. SIERRA) 8.1L
- 2007 8 GMC SIERRA 2500 HD CLASSIC 6.0L
- 2007 8 GMC SIERRA 2500 HD CLASSIC 8.1L
- 2007 8 GMC SIERRA 3500 CLASSIC 6.0L
- 2007 8 GMC SIERRA 3500 CLASSIC 8.1L

### 9991

Inlet A: LOOSE 3-BOLT FLANGE W/ FEMALE FLARE  
 Inlet B: WELDED 3-BOLT FLANGE  
 Outlet A: WELDED 2-BOLT FLANGE  
 Length: 59"



- 2006-03 6 CHEVROLET G -VAN 1/2 & 3/4 TON (Inc. Express Van) 4.3L
- 2005-03 8 CHEVROLET G -VAN 1/2 & 3/4 TON (Inc. Express Van) 5.3L
- 2005-03 8 GMC G -VAN 1/2 & 3/4 TON (Inc. Savana Van) 5.3L
- 2006-03 6 GMC G -VAN 1/2 & 3/4 TON (Inc. Savana Van) 4.3L

# DIRECT FIT

## 9992

Inlet A: WELDED 3-BOLT FLANGE  
 Outlet A: 3" O.D. PIPE  
 Length: 63"



- 2005-03 8 CHEVROLET G -VAN 1 TON (Inc. Express Van) 6.0L
- 2005-03 8 CHEVROLET G -VAN 1/2 & 3/4 TON (Inc. Express Van) 4.8L
- 2005-03 8 CHEVROLET G -VAN 1/2 & 3/4 TON (Inc. Express Van) 6.0L
- 2005-03 8 GMC G -VAN 1 TON (Inc. Savana Van) 6.0L
- 2005-03 8 GMC G -VAN 1/2 & 3/4 TON (Inc. Savana Van) 4.8L
- 2005-03 8 GMC G -VAN 1/2 & 3/4 TON (Inc. Savana Van) 6.0L

## 9994

Inlet A: WELDED 3-BOLT FLANGE  
 Outlet A: WELDED 3-BOLT FLANGE  
 Length: 60"



- 2009-06 8 CHEVROLET G -VAN 1 TON (Inc. Express Van) 6.0L
- 2009-06 8 CHEVROLET G -VAN 1/2 & 3/4 TON (Inc. Express Van) 4.8L
- 2009-06 8 CHEVROLET G -VAN 1/2 & 3/4 TON (Inc. Express Van) 6.0L
- 2009-06 8 GMC G -VAN 1 TON (Inc. Savana Van) 6.0L
- 2009-06 8 GMC G -VAN 1/2 & 3/4 TON (Inc. Savana Van) 4.8L
- 2009-06 8 GMC G -VAN 1/2 & 3/4 TON (Inc. Savana Van) 6.0L

## 9993

Inlet A: WELDED 3-BOLT FLANGE  
 Outlet A: WELDED 3-BOLT FLANGE  
 Length: 61.25"



- 2005-03 8 CHEVROLET G -VAN 1 TON (Inc. Express Van) 6.0L
- 2005-03 8 CHEVROLET G -VAN 1/2 & 3/4 TON (Inc. Express Van) 4.8L
- 2005-03 8 CHEVROLET G -VAN 1/2 & 3/4 TON (Inc. Express Van) 6.0L
- 2005-03 8 GMC G -VAN 1 TON (Inc. Savana Van) 6.0L
- 2005-03 8 GMC G -VAN 1/2 & 3/4 TON (Inc. Savana Van) 4.8L
- 2005-03 8 GMC G -VAN 1/2 & 3/4 TON (Inc. Savana Van) 6.0L

## 9995

Inlet A: WELDED 3-BOLT FLANGE  
 Outlet A: 3" O.D. PIPE  
 Length: 61"



- 2009-06 8 CHEVROLET G -VAN 1 TON (Inc. Express Van) 6.0L
- 2009-06 8 CHEVROLET G -VAN 1/2 & 3/4 TON (Inc. Express Van) 4.8L
- 2009-06 8 CHEVROLET G -VAN 1/2 & 3/4 TON (Inc. Express Van) 6.0L
- 2009-06 8 GMC G -VAN 1 TON (Inc. Savana Van) 6.0L
- 2009-06 8 GMC G -VAN 1/2 & 3/4 TON (Inc. Savana Van) 4.8L
- 2009-06 8 GMC G -VAN 1/2 & 3/4 TON (Inc. Savana Van) 6.0L



### 9996

Inlet A: LOOSE 3-BOLT FLANGE W/ SPHERICAL FLARE  
 Inlet B: LOOSE 3-BOLT FLANGE W/ SPHERICAL FLARE  
 Outlet A: WELDED 2-BOLT FLANGE  
 Length: 46"



2003-01 6 CHEVROLET S-Series (2WD), T-Series (4WD)  
 PICKUP 4.3L

### 9997

Inlet A: LOOSE 2-BOLT FLANGE W/ SPHERICAL FLARE  
 Inlet B: LOOSE 2-BOLT FLANGE W/ SPHERICAL FLARE  
 Outlet A: 2.50" O.D. PIPE  
 Length: 50"

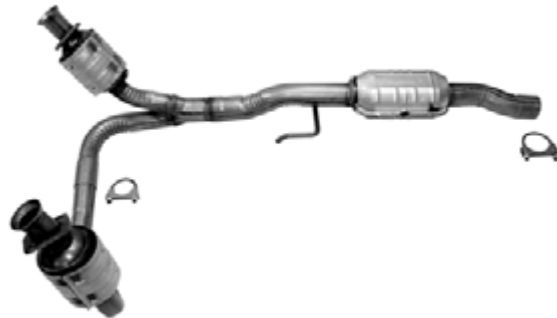

2002-00 8 DODGE DAKOTA 4.7L

### 9998

Inlet A: LOOSE 3-BOLT FLANGE W/ SPHERICAL FLARE  
 Outlet A: WELDED 2-BOLT FLANGE  
 Length: 61.25"



2005-02 6 CHEVROLET TRAILBLAZER EXT 4.2L  
 2005-02 6 GMC ENVOY XL 4.2L  
 2005-04 6 GMC ENVOY XUV 4.2L  
 2005-04 6 ISUZU ASCENDER 4.2L

### 10900

Inlet A: 3" I.D. PIPE  
 Outlet A: 3" O.D. PIPE  
 Length: 30"



1995-87 8 FORD F-250 PICKUP 3/4 TON 5.8L  
 1995-87 8 FORD F-250 PICKUP 3/4 TON 7.5L  
 1997-88 8 FORD F-350 PICKUP 1 TON 5.8L  
 1997-88 8 FORD F-350 PICKUP 1 TON 7.5L

### 10901

Inlet A: WELDED 4-BOLT FLANGE W/ STUDS  
 Outlet A: 3" O.D. PIPE  
 Length: 29.25"



1997-87 8 FORD F-250 PICKUP 3/4 TON 5.8L  
 1997-87 8 FORD F-250 PICKUP 3/4 TON 7.5L  
 1997-88 8 FORD F-350 PICKUP 1 TON 5.8L  
 1997-88 8 FORD F-350 PICKUP 1 TON 7.5L  
 1995-94 8 FORD F-450 PICKUP 1-1/2 TON 7.5L

### 10902

Inlet A: WELDED 4-BOLT FLANGE W/ STUDS  
 Outlet A: 2.50" O.D. PIPE  
 Length: 29.25"



1993-87 8 FORD E-250 VAN 3/4 TON 7.5L  
 1995-88 8 FORD E-250 VAN 3/4 TON 5.8L  
 1989-88 8 FORD E-350 VAN 1 TON 5.8L  
 1995-87 8 FORD E-350 VAN 1 TON 7.5L  
 1997-87 8 FORD F-250 PICKUP 3/4 TON 5.8L  
 1997-87 8 FORD F-250 PICKUP 3/4 TON 7.5L  
 1998 8 FORD F-250 PICKUP 3/4 TON 5.4L  
 1997-87 8 FORD F-350 PICKUP 1 TON 5.8L  
 1997-87 8 FORD F-350 PICKUP 1 TON 7.5L  
 1993-90 8 FORD F-450 PICKUP 1-1/2 TON 7.5L

# DIRECT FIT

## 10903

Inlet A: 3" I.D. PIPE  
 Outlet A: 3" O.D. PIPE  
 Length: 26"



- 1995-88 8 CHEVROLET C-(2WD), K-(4WD) PICKUP 1 TON, (Inc. SILVERADO) All
- 1993-88 8 CHEVROLET C-(2WD), K-(4WD) PICKUP 3/4 TON, (Inc. SILVERADO & AVALANCHE) 5.7L
- 1995-91 8 CHEVROLET C-(2WD), K-(4WD) PICKUP 3/4 TON, (Inc. SILVERADO & AVALANCHE) 7.4L
- 1991-87 8 CHEVROLET G -VAN 1 TON (Inc. Express Van) 5.7L
- 1994-92 8 CHEVROLET G -VAN 1 TON (Inc. Express Van) All
- 1994-87 8 CHEVROLET G -VAN 1/2 & 3/4 TON (Inc. Express Van) 5.7L
- 1989-87 8 CHEVROLET R-(2WD), V-(4WD) PICKUP 7.4L
- 1993-88 8 CHEVROLET SUBURBAN/TAHOE 5.7L
- 1995-87 8 CHEVROLET SUBURBAN/TAHOE 7.4L
- 1995-88 8 GMC C-(2WD), K-(4WD) PICKUP 1 TON, (Inc. SIERRA) All
- 1993-88 8 GMC C-(2WD), K-(4WD) PICKUP 3/4 TON, (Inc. SIERRA) 5.7L
- 1995-91 8 GMC C-(2WD), K-(4WD) PICKUP 3/4 TON, (Inc. SIERRA) 7.4L
- 1991-87 8 GMC G -VAN 1 TON (Inc. Savana Van) 5.7L
- 1994-92 8 GMC G -VAN 1 TON (Inc. Savana Van) All
- 1994-87 8 GMC G -VAN 1/2 & 3/4 TON (Inc. Savana Van) 5.7L
- 1993-88 8 GMC SUBURBAN/YUKON 5.7L
- 1995-87 8 GMC SUBURBAN/YUKON 7.4L

## 10904

Inlet A: WELDED 3-BOLT FLANGE  
 Outlet A: 3" O.D. PIPE  
 Length: 56"



- 2004 8 FORD F-350 PICKUP 1 TON 5.4L

## 10920

Inlet A: WELDED 3-BOLT FLANGE W/ STUDS  
 Outlet A: 3" O.D. PIPE  
 Length: 38.25"



- 1999-97 8 FORD E-250 VAN 3/4 TON 5.4L
- 1998-97 10 FORD E-350 VAN 1 TON 6.8L
- 1998-97 8 FORD E-350 VAN 1 TON 5.4L
- 1999 8 FORD F-250 PICKUP 3/4 TON 5.4L
- 1999 10 FORD F-350 PICKUP 1 TON 6.8L

## 10921

Inlet A: WELDED 3-BOLT FLANGE  
 Outlet A: 3" O.D. PIPE  
 Length: 31.25"



- 2000-98 8 BLUE BIRD BUS CV200 7.4L
- 2000-98 8 GMC B7 CONVENTIONAL CHASSIS 7.4L

## 10922

Inlet A: WELDED 3-BOLT FLANGE  
 Outlet A: 3" O.D. PIPE  
 Length: 35.25"



- 2000-97 10 FORD E-350 VAN 1 TON 6.8L

## 10923

Inlet A: WELDED 3-BOLT FLANGE  
 Outlet A: 3" O.D. PIPE  
 Length: 35.25"



- 1999 10 FORD F-350 PICKUP 1 TON 6.8L
- 1999 10 FORD F-450 PICKUP 1-1/2 TON 6.8L

### 10924

Inlet A: WELDED 3-BOLT FLANGE  
 Outlet A: 3" O.D. PIPE  
 Length: 56.50"



- 2002-00 10 FORD EXCURSION 6.8L
- 2002-00 8 FORD EXCURSION 5.4L
- 2003-00 8 FORD F-250 PICKUP 3/4 TON 5.4L
- 2003-99 10 FORD F-250 PICKUP 3/4 TON 6.8L
- 2003-99 10 FORD F-350 PICKUP 1 TON 6.8L
- 2003-99 8 FORD F-350 PICKUP 1 TON 5.4L

### 10925

Inlet A: WELDED 3-BOLT FLANGE  
 Outlet A: 3" O.D. PIPE  
 Length: 35.25"



- 2000-97 10 FORD E-350 VAN 1 TON 6.8L

### 10926

Inlet A: WELDED 3-BOLT FLANGE  
 Outlet A: 3" O.D. PIPE  
 Length: 45.75"



- 2007-06 10 FORD E-350 VAN 1 TON 6.8L
- 2007-06 10 FORD E-450 VAN 6.8L

### 10927

Inlet A: 3" I.D. PIPE  
 Outlet A: 3" O.D. PIPE  
 Length: 47"



- 2007-04 10 FORD E-450 VAN 6.8L

### 10928

Inlet A: 3" I.D. PIPE  
 Outlet A: 3" O.D. PIPE  
 Length: 39.50"



- 2000-97 10 FORD E-350 VAN 1 TON 6.8L

### 10930

Inlet A: WELDED 3-BOLT FLANGE  
 Outlet A: 3" O.D. PIPE  
 Length: 38"



- 2004-02 8 FORD E-150 VAN 1/2 TON 5.4L
- 2004-02 8 FORD E-250 VAN 3/4 TON 5.4L

### 10931

Inlet A: WELDED 3-BOLT FLANGE  
 Outlet A: 3" O.D. PIPE  
 Length: 35"



- 1999 10 FORD F-250 PICKUP 3/4 TON 6.8L
- 1999 8 FORD F-250 PICKUP 3/4 TON 5.4L
- 1999 10 FORD F-350 PICKUP 1 TON 6.8L
- 1999 10 FORD F-450 PICKUP 1-1/2 TON 6.8L

### 10932

Inlet A: WELDED 4-BOLT FLANGE  
 Outlet A: 3" O.D. PIPE  
 Length: 32.25"



- 2007-05 10 FORD F-250 PICKUP 3/4 TON 6.8L
- 2007-05 8 FORD F-250 PICKUP 3/4 TON 5.4L
- 2007-05 10 FORD F-350 PICKUP 1 TON 6.8L
- 2007-05 8 FORD F-350 PICKUP 1 TON 5.4L
- 2007-05 10 FORD F-450 PICKUP 1-1/2 TON 6.8L

# DIRECT FIT

## 10932 (cont.)

2007-05 10 FORD F-550 SUPER DUTY 6.8L

## 10933

Inlet A: WELDED 3-BOLT FLANGE  
 Outlet A: 3" O.D. PIPE  
 Length: 34.75"



2008-07 10 FORD E-350 VAN 1 TON 6.8L  
 2008-07 8 FORD E-350 VAN 1 TON 5.4L  
 2008 10 FORD E-450 VAN 6.8L  
 2008 8 FORD E-450 VAN 5.4L

## 10935

Inlet A: 2.25" I.D. PIPE  
 Outlet A: 2.25" O.D. PIPE  
 Length: 24"

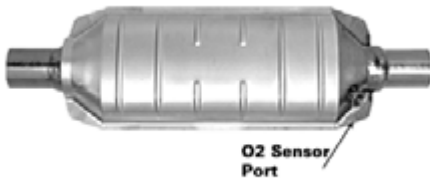

1996-94 8 DODGE RAM (2WD & 4WD) PICKUP 1 TON 5.9L

## 10936

Inlet A: 2.25" I.D. PIPE  
 Outlet A: 2.25" O.D. PIPE  
 Length: 23.25"



2002-94 10 DODGE RAM (2WD & 4WD) PICKUP 1 TON 8.0L  
 2002-94 10 DODGE RAM (2WD & 4WD) PICKUP 1/2 & 3/4 TON 8.0L

## 10937

Inlet A: 3" I.D. PIPE  
 Outlet A: 2.88" I.D. PIPE  
 Length: 46.75"



2006-00 10 FORD E-450 VAN 6.8L

## 10937 (cont.)

2006-00 8 FORD E-450 VAN 5.4L  
 2003 10 FORD E-550 SUPER DUTY 6.8L

## 10938

Inlet A: WELDED 4-BOLT FLANGE  
 Outlet A: 3" O.D. PIPE  
 Length: 30"



2007-05 10 FORD F-250 PICKUP 3/4 TON 6.8L  
 2007-05 8 FORD F-250 PICKUP 3/4 TON 5.4L  
 2007-05 10 FORD F-350 PICKUP 1 TON 6.8L  
 2007-05 8 FORD F-350 PICKUP 1 TON 5.4L  
 2007-05 10 FORD F-450 PICKUP 1-1/2 TON 6.8L  
 2007-05 10 FORD F-550 SUPER DUTY 6.8L

## 10973

Inlet A: LOOSE 2-BOLT FLANGE W/ 2.25" FEMALE FLARE  
 Inlet B: LOOSE 2-BOLT FLANGE W/ 2.50" FEMALE FLARE  
 Outlet A: 2.50" O.D. PIPE  
 Length: 63.25"

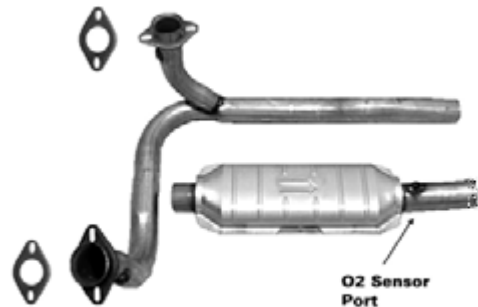

1996 8 FORD E-250 VAN 3/4 TON 5.8L  
 1996 8 FORD E-350 VAN 1 TON 5.8L

## 10981

Inlet A: 3" I.D. PIPE  
 Outlet A: 3" O.D. PIPE  
 Length: 24"

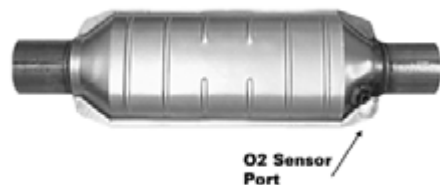

1996-95 10 DODGE RAM (2WD & 4WD) PICKUP 1 TON 8.0L

**OXYGEN SENSOR ACCESSORIES**

**4961**  
**18 mm Male O2 Sensor Plug**  
10 per box



**4752**  
**12 mm Female O2 Sensor Boss**  
10 per box



**4962**  
**18 mm Female O2 Sensor Boss**  
10 per box



**4753**  
**Toyota, Lexus, GEO, Mitsubishi,  
Subaru, Chrysler Imports:**  
**2 Bolt O2 sensor Boss**  
10 per box



**For O2 sensor gaskets,  
see page 483 for #9224, 9242  
and  
page 484 for #9291, 9299.**

**4751**  
**18 mm Female O2 Sensor Boss,  
45 Deg. cut**  
10 per box



**AIR TUBE REPLACEMENTS**

**4948**  
**UNIVERSAL AIR TUBE KIT - SINGLE**

Fits 1/2" & 3/4" Air Tubes  
Allows for easy connection from OEM air tube to  
aftermarket converter.

INCLUDES: 12" of 3/4" High Temp. Hose,  
(2) Hose Clamps, (2) High Temp.  
Thermo Plastic Hose Size Adapters.



**4949**  
**UNIVERSAL AIR TUBE KIT - (6) PER/BOX**

## HIGH TEMP - REPLACEMENT HOSE

HIGH TEMP HOSES-FOR USE IN AIR INJECTION SYSTEM REPAIRS.



### 1/2" I.D. DIAMETER

**4754** - 12" Length

**4937** - Bulk 10' Length

### 5/8" I.D. DIAMETER

**4756** - 12" Length

**4757** - Bulk 10' Length

### 3/4" I.D. DIAMETER

**4758** - 12" Length

**4938** - Bulk 10' Length

## CLAMPS

### STANDARD DUTY 5/16" U-BOLT



P/N	SIZE	BOX QTY
U118	1 1/8"	1
U114	1 1/4"	1
U112	1 1/2"	1
U158	1 5/8"	1
U134	1 3/4"	1
U178	1 7/8"	1
U200	2"	1
U218	2 1/8"	1
U214	2 1/4"	1
U212	2 1/2"	1

### STANDARD DUTY 5/16" U-BOLT W/ FLANGE NUT



P/N	SIZE	BOX QTY
339976	1 1/2"	50
339977	1 5/8"	50
339978	1 3/4"	50
339979	1 7/8"	50
339980	2"	50
339981	2 1/8"	50
339982	2 1/4"	50
339983	2 1/2"	50

### SLOTTED HD 3/8" U-BOLT W/ FLANGE NUT



P/N	SIZE	BOX QTY
339893	1 1/2"	100
339892	1 3/4"	100
339891	1 7/8"	100
339890	2"	100
339889	2 1/4"	100
339888	2 1/2"	100

### DGM STYLE 3/8" U-BOLT W/ FLANGE NUT



P/N	SIZE	BOX QTY	P/N	SIZE	BOX QTY
M112	1 1/2"	1	339862	1 1/2"	100
M158	1 5/8"	1			
M134	1 3/4"	1	339880	1 3/4"	100
M178	1 7/8"	1	339879	1 7/8"	100
M200	2"	1	339878	2"	100
M218	2 1/8"	1	339877	2 1/8"	100
M214	2 1/4"	1	339876	2 1/4"	100
M212	2 1/2"	1	339875	2 1/2"	100
M258	2 5/8"	1			
M300	3"	1	9972	3"	50

### CLAMPS - (Cont.)

#### HEAVY DUTY 3/8" U-BOLT TRUCK CLAMPS



P/N	P/N ZINC	SIZE	BOX QTY
H234P	—	2 3/4"	1
H300P	H300PZ	3"	1
H312P	H312PZ	3 1/2"	1
H400P	H400PZ	4"	1
H412P	H412PZ	4 1/2"	1
H500P	H500PZ	5"	1

#### EXTRA HEAVY DUTY CLAMPS 3/8" U-BOLT 11 GAUGE SADDLE



P/N	P/N ZINC	SIZE	BOX QTY	P/N	P/N ZINC	SIZE	BOX QTY
H200	—	2"	1	H300*	H300Z	3"	1
H218	—	2 1/8"	1	H314*	—	3 1/4"	1
H214	—	2 1/4"	1	H312*	—	3 1/2"	1
H238	—	2 3/8"	1	H400*	H400Z	4"	1
H212	—	2 1/2"	1	H412*	—	4 1/2"	1
H258*	—	2 5/8"	1	H500*	H500Z	5"	1
H234*	—	2 3/4"	1	H600*	H600Z	6"	1

\*Welded Saddle

#### STAINLESS STEEL 3/8" U-BOLT



P/N	SIZE	BOX QTY
SS112	1 1/2"	1
SS134	1 3/4"	1
SS178	1 7/8"	1
SS200	2"	1
SS214	2 1/4"	1
SS212	2 1/2"	1
SS300	3"	1

#### FLAT BAND CLAMPS



P/N ZINC	P/N CHROME	SIZE	BOX QTY
9501	9490	3"	1
9502	—	3 1/2"	1
9503	9492	4"	1
9504	9493	5"	1
9736	—	5 1/2"	1
9506	9495	6"	1

#### HEAVY DUTY GUILLOTINE CLAMPS



P/N	P/N ZINC	P/N CHROME	SIZE	BOX QTY
T234	—	—	2 3/4"	1
T300	T300Z	—	3"	1
T314	—	—	3 1/4"	1
T312	T312Z	—	3 1/2"	1
T400	T400Z	9486	4"	1
—	T412Z	—	4 1/2"	1
T500	T500Z	9487	5"	1
—	T512Z	—	5 1/2"	1
T600	T600Z	9734	6"	1

#### AIR TUBE SADDLE CLAMPS



P/N	SIZE	BOX QTY
4904	1/2"	25
4914	5/8"	25
4907	3/4"	25
4925	1"	25

## FLEX COUPLING

- Complete Coverage
- Constructed with 2-Ply Bellows
- Designed with a Seamless, Convolute Inner Core to Prevent Exhaust Leaks
- Increased Flexibility Reduces Vibrations
- Available with or without Expandable Nipple Extensions
- Available with Inner Braid



### WITHOUT NIPPLE EXTENSION

P/N W/O INNER LINER	P/N WITH INNER BRAID	FLEX LENGTH	OVERALL LENGTH	INLET DIAMETER
8810	8810IB	4"	4"	1.77"
8811	8811IB	6"	6"	1.77"
8812	8812IB	8"	8"	1.77"
8813	8813IB	10"	10"	1.77"
8814	8814IB	4"	4"	2.02"
8815	8815IB	6"	6"	2.02"
8816	8816IB	8"	8"	2.02"
8817	8817IB	10"	10"	2.02"
8818	8818IB	4"	4"	2.27"
8819	8819IB	6"	6"	2.27"
8820	8820IB	8"	8"	2.27"
8821	8821IB	10"	10"	2.27"
8822	8822IB	4"	4"	2.52"
8823	8823IB	6"	6"	2.52"
8824	8824IB	8"	8"	2.52"
8825	8825IB	10"	10"	2.52"
8826	8826IB	4"	4"	3.02"
8827	8827IB	6"	6"	3.02"
8828	8828IB	8"	8"	3.02"
8829	8829IB	10"	10"	3.02"

### WITH NIPPLE EXTENSION

P/N W/O INNER LINER	P/N WITH INNER BRAID	FLEX LENGTH	OVERALL LENGTH	INLET DIAMETER
8835	8835IB	4"	8"	1.75"
8836	8836IB	6"	10"	1.75"
8837	8837IB	8"	12"	1.75"
8838	8838IB	10"	14"	1.75"
8839	8839IB	4"	8"	2.00"
8840	8840IB	6"	10"	2.00"
8841	8841IB	8"	12"	2.00"
8842	8842IB	10"	14"	2.00"
8843	8843IB	4"	8"	2.25"
8844	8844IB	6"	10"	2.25"
8845	8845IB	8"	12"	2.25"
8846	8846IB	10"	14"	2.25"
8847	8847IB	4"	8"	2.50"
8848	8848IB	6"	10"	2.50"
8849	8849IB	8"	12"	2.50"
8850	8850IB	10"	14"	2.50"
8851	8851IB	4"	8"	3.00"
8852	8852IB	6"	10"	3.00"
8853	8853IB	8"	12"	3.00"
8854	8854IB	10"	14"	3.00"

## MANIFOLD SHOULDER BOLTS & SPRINGS



**4678**  
Acura/Chrysler/  
Honda/Subaru



**4682**  
Acura/Honda  
(2 each per kit)



**4975**  
Chrysler



**4973**  
Ford/Mazda



**4971S** (Single)  
GM/Ford/Mazda  
**4971** (10/box)



**4976**  
GM/Chrysler



### MANIFOLD SHOULDER BOLTS & SPRINGS - (Cont.)



**4680**  
GM/Geo/Suzuki/Toyota



**4970**  
GM/Subaru



**4972**  
GM



**4974**  
GM



**8037**  
GM



**8038**  
GM



**8039**  
Subaru



**4978**  
Toyota



**4979**  
Toyota



**F5309**  
Universal Spring  
(10 per box)

### JOINT CONNECTOR

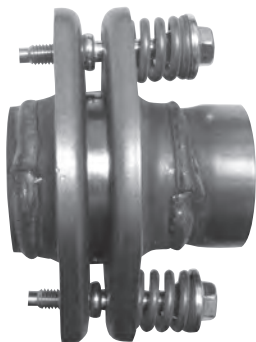

**P/N**  
**8802**

**DESCRIPTION**

Fits 1 3/4" and 2" pipes  
Gasket included.  
Stainless Steel

### CLAMP-A-STUD



P/N	SIZE	BOX QTY
8028	1/4" - 1 3/4"	1
8027	1 1/4" - 2 1/4"	1
8026	2 1/4" - 3 1/4"	1

## The HUSH Studfix

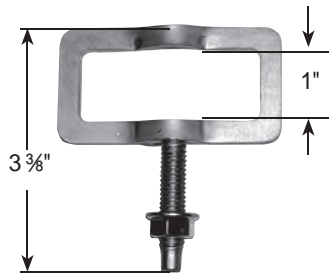

8001 - Pkg. Qty. 2  
Ford Trucks

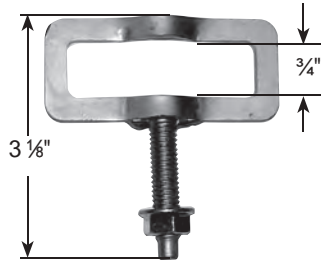

8002 - Pkg. Qty. 2  
Ford Cars

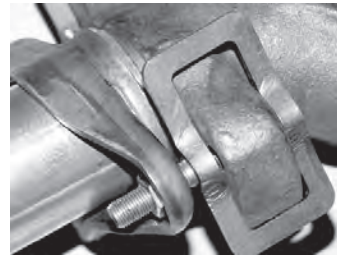

The HUSH Studfix installed

## SPLIT FLANGES & MISC.

### SPLIT CONVERTER FLANGES

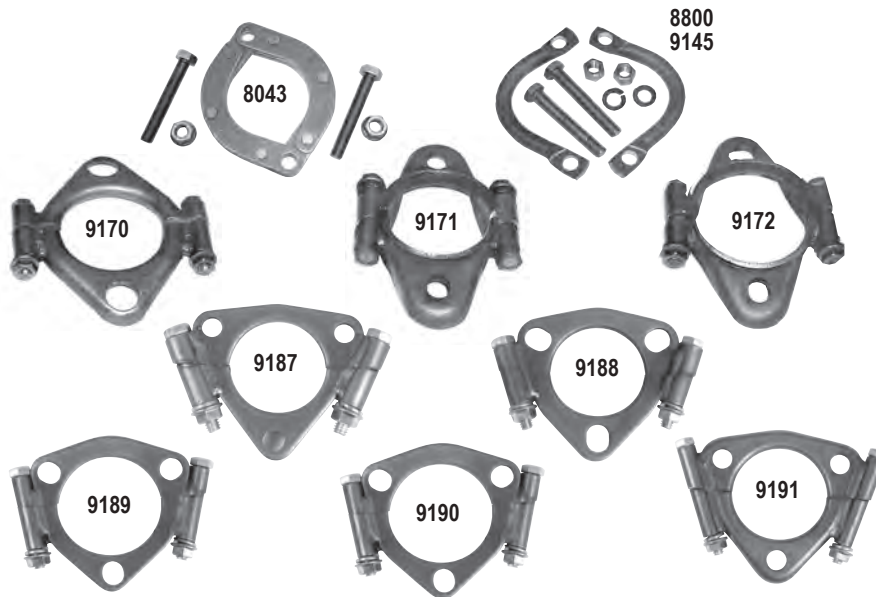

P/N	SIZE	BOX QTY
9145	1 3/4" - 2"	1
9187	1 7/8"	1
8043	2" - 2 1/4"	1
9171	2 3/32"	1
9188	2 1/8"	1
8800	2 1/4" - 2 1/2"	1
9170	2 5/16"	1
9172	2 7/16"	1
9191	2 7/16"	1
9189	2 1/2"	1
9190	2 5/8"	1

### SPLIT FLANGES Individually Boxed

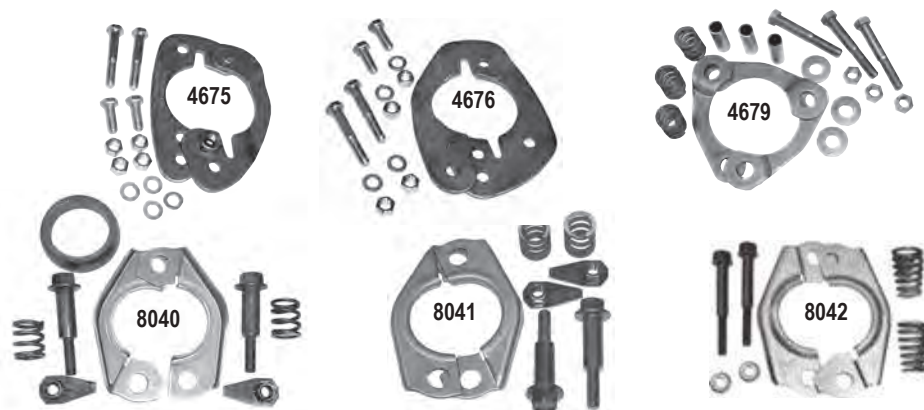

P/N	TYPE
4675	GM
4676	Universal
4679	GM
8040	Ford
8041	Ford
8042	Chrysler
8044	Repair Kit

### UNIVERSAL & SPECIAL APPLICATION FLANGES

#### 3-HOLE UNIVERSAL FLANGE



P/N	SIZE	BOX QTY
9152	2"	10
9152S	2"	1
8032	2 5/8"	1
8033	3 1/16"	1

#### 2-HOLE UNIVERSAL FLANGE



P/N	SIZE	BOX QTY
9153	1 3/4"	10
9153S	1 3/4"	1
8036	1 3/4"	1

Note: 9153, 9153S - 5/16" thick  
8036 - 3/8" thick

#### 2-HOLE UNIVERSAL FLANGE



P/N	SIZE	BOX QTY
9154	2 1/8"	10
9154S	2 1/8"	1

#### 2-HOLE UNIVERSAL FLANGE



P/N	SIZE	BOX QTY
9155	2 5/16"	10
9155S	2 5/16"	1
8035	2 3/8"	1

#### 2-HOLE UNIVERSAL FLANGE



P/N	SIZE	BOX QTY
9156	2 9/16"	10
9156S	2 9/16"	1

#### 3-HOLE UNIVERSAL FLANGE



P/N	SIZE	BOX QTY
9158	2 5/16"	10
9158S	2 5/16"	1

#### 4-HOLE GM FLANGE



P/N	SIZE	BOX QTY
9160	2 1/4"	10
9160S	2 1/4"	1

#### 4-HOLE GM FLANGE



P/N	SIZE	BOX QTY
9161	2"	10
9161S	2"	1

#### OEM STYLE FLANGE - FORD



P/N	SIZE	BOX QTY
8029	2 5/16"	1

#### OEM STYLE FLANGE - FORD



P/N	SIZE	BOX QTY
8030	2 1/16"	1

#### OEM STYLE FLANGE - FORD



P/N	SIZE	BOX QTY
8031	2 5/16"	1

## EXHAUST PIPE FLANGE CHARTS

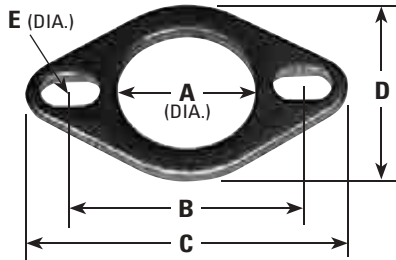

P/N	A	B	C	D	E
8035	2 3/8"	3 7/8"	5 1/4"	3 1/2"	1/2" x 7/8" slot
8036	1 3/4"	3 1/2"	4 3/4"	3"	1/2" x 3/4" slot
8788	2"	3"	4"	2 3/4"	1/2"
8793	2 1/8"	3 1/8"	3 7/8"	3"	7/16"
9153#	1 3/4"	3 1/2"	4 3/4"	3"	1/2" x 3/4" slot
9153S	1 3/4"	3 1/2"	4 3/4"	3"	1/2" x 3/4" slot
9154#	2 1/8"	3 1/2"	4 3/4"	3"	1/2" x 3/4" slot
9154S	2 1/8"	3 1/2"	4 3/4"	3"	1/2" x 3/4" slot
9155#	2 5/16"	3 7/8"	5 1/4"	3 1/2"	1/2" x 7/8" slot
9155S	2 5/16"	3 7/8"	5 1/4"	3 1/2"	1/2" x 7/8" slot
9156#	2 9/16"	3 7/8"	5 1/4"	3 1/2"	1/2" x 7/8" slot
9156S	2 9/16"	3 7/8"	5 1/4"	3 1/2"	1/2" x 7/8" slot
9175	1 7/8"	3 1/16"	4 1/4"	2 3/4"	9/16" x 1 1/16" slot
9176	2 1/16"	3 1/16"	4 1/4"	2 3/4"	9/16" x 1 1/16" slot
9179	2 1/16"	3 1/2"	4 7/8"	3 1/16"	7/16" x 7/8" slot
9181	2"	3 1/2"	4 3/4"	3"	1/2" x 3/4" slot
9184	2 1/16"	3"	4"	2 3/4"	1/2"
9185	2 1/4"	3 7/16"	4 1/2"	3"	1/2"

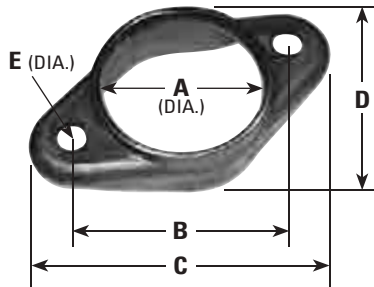

P/N	A	B	C	D	E
8776	2 1/8"	3 1/8"	4 1/2"	3 1/4"	7/16"
8777	2 7/16"	3 5/8"	5"	2 7/8"	7/16" x 9/16" slot
8786	2 7/16"	3 3/4"	5 1/8"	2 15/16"	7/16"
8792	2 1 1/16"	3 3/4"	5 1/4"	2 7/8"	7/16"
8796	2 1/4"	3 9/16"	5"	2 3/4"	3/8" x 7/16" slot
8798	2 1/8"	3 3/4"	5 1/8"	2 3/8"	7/16"
9569	2 31/32"	4 3/32"	5 1/2"	3 1/2"	7/16"
9147	2 5/16"	4"	5 3/8"	3 3/8"	1 3/16"
9150	2 1/8"	3 5/8"	4 3/4"	2 9/16"	7/16" x 9/16" slot
9162	2 9/8"	4 3/4"	6 1/8"	3"	7/16"
9166	3 1/12"	4 1/4"	6 5/64"	3 9/16"	7/16"
9167	2 1/2"	4"	5 3/8"	3 3/8"	3/4"

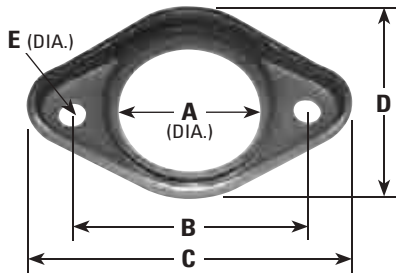

P/N	A	B	C	D	E
8789	2 1/16"	3 1/8"	4 1/8"	3 1/4"	1/2"
9140	2 1/4"	4"	5 7/16"	3 3/8"	7/16"
9164	2 9/16"	3 15/16"	5 1/8"	3 7/16"	2 3/32"

### EXHAUST PIPE FLANGE CHARTS

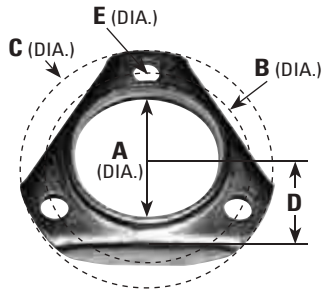

P/N	A	B	C	D	E
8780	2 1/8"	3 1/8"	3 7/8"	1 7/16"	7/16"

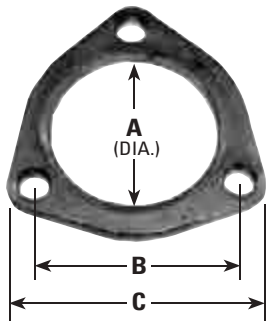

P/N	A	B	C
8032	2 5/8"	3 3/16"	3 7/8"
8033	3 1/16"	3 5/16"	4 1/8"
8034	2 5/8"	3 1/16"	3 7/8"
8799	2 7/16"	2 13/16"	3 5/8"
9152#	2"	2 11/16"	3 3/4"
9152S	2"	2 11/16"	3 3/4"
9158#	2 5/16"	2 11/16"	3 15/16"
9158S	2 5/16"	2 11/16"	3 15/16"
9173	2 1/2"	3 1/8"	3 15/16"
9177	2 1/8"	2 11/16"	3 5/8" (rad.)
9178	2 5/8"	3 1/16"	3 7/8"
9180	3 1/16"	3 5/16"	4 1/8"

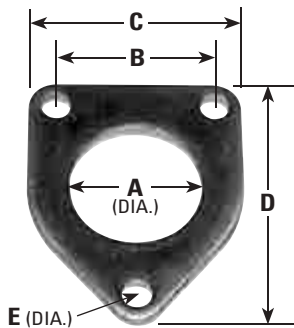

P/N	A	B	C	D	E
9174	2"	2 7/16"	3 3/8"	4 3/16"	7/16"

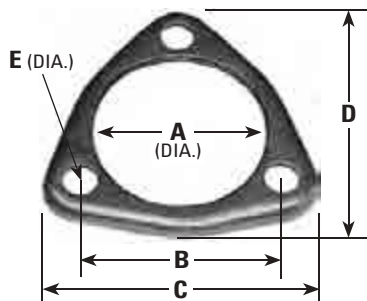

P/N	A	B	C	D	E
8775	2 5/16"	2 7/8"	4 5/16" (rad.)	4 1/2" (rad.)	7/16"
8787	2 11/16"	3 1/8"	4 5/16" (rad.)	4 1/8" (rad.)	1/2"
9146	2 5/8"	3 1/2"	4 33/64" (rad.)	4 19/64" (rad.)	27/64"

## EXHAUST PIPE FLANGE CHARTS

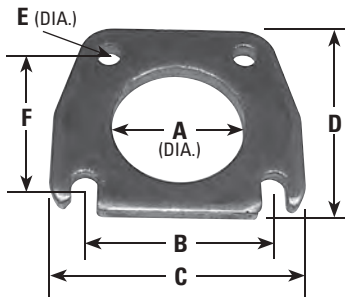

P/N	A	B	C	D	E	F
9160#	2 1/4"	2 3/8"/3 3/16"	4 5/16"	3 5/8"	7/16"	2 9/16"
9160S	2 1/4"	2 3/8"/3 3/16"	4 5/16"	3 5/8"	7/16"	2 9/16"
9161#	2"	2 3/8"/3 3/16"	4 1/4"	3 21/32"	7/16"	2 9/16"
9161S	2"	2 3/8"/3 3/16"	4 1/4"	3 21/32"	7/16"	2 9/16"

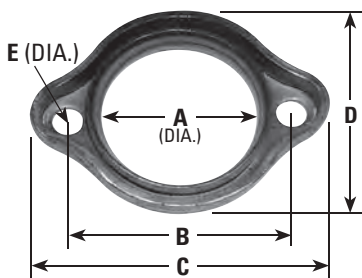

P/N	A	B	C	D	E
8029	2 9/16"	3 3/4"	4 15/16"	3 9/16"	1/2"
8030	2 1/16"	3 1/2"	4 5/8"	3 3/8"	1/2"
8031	2 5/16"	3 13/16"	4 15/16"	3 9/16"	1/2"
8778	2 7/16"	4 1/16"	4 1/2"	3 9/16"	9/16"
8781	2 1/8"	3 1/8"	4 1/4"	3 1/4"	7/16"
9159	2 1/8"	3 1/2"	4 3/4"	3"	1/2 x 3/4" slot

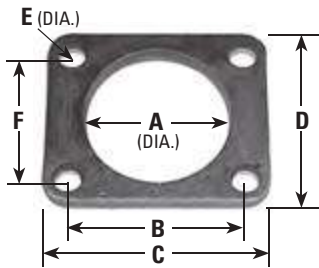

P/N	A	B	C	D	E	F
9143	2 9/16"	2 13/16"	3 9/16"	3 1/4"	3/8"	2 7/16"
9586	4 1/8"	4 3/16"	6"	6"	5/8"	4 3/16"

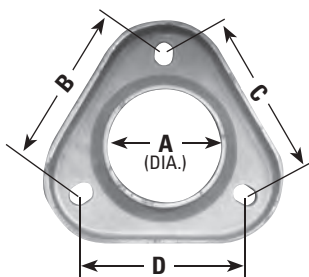

P/N	A	B	C	D
9149	2 9/16"	3 11/16"	3 11/16"	3 13/16"

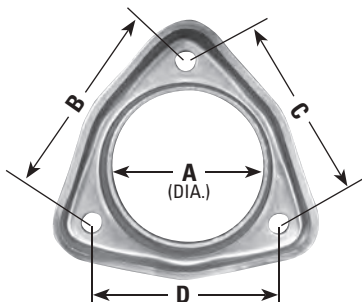

P/N	A	B	C	D
9165	2 27/32"	3 11/16"	3 5/8"	3 13/16"

### EXHAUST GASKET CHARTS

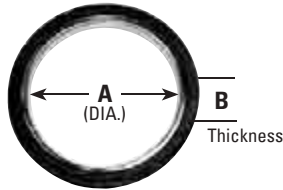

GASKET NO.	A	B
8421	3 3/32"	3/16"
8449	3 13/32"	7/32"
8470	2 13/16"	5/32"
8690	1 3/4"	3/16"
8731°	2"	1/16"
8733	1 15/16"	5/32"
8737	2 5/32"	3/16"
8749	1 13/16"	3/16"
8764°	5 9/64"	3/16"
8770	1 9/16"	3/16"
9016	2 3/8"	3/16"
9024	1 31/32"	3/16"
9026	2 19/32"	3/16"
9027	2 3/16"	1/8"
9066	1 7/8"	3/16"
9100	2 1/16"	1/16"
9207	2 31/32"	3/16"
9218°	2 3/4"	3/16"
9233	2 1/32"	15/32"
9282	2 3/8"	3/16"

° Metal with Fiber Core

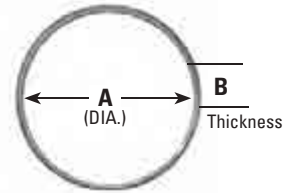

GASKET NO.	A	B
8424	2 7/16"	5/32"
8437	4 7/32"	1/8"
8457	2 29/32"	1 1/64"
8467	2 9/16"	5/32"
8469	3 3/16"	5/32"
8693	2"	3/16"
8702	2 9/32"	3/16"
8762	2 13/16"	5/32"
9044	2 13/32"	7/32"
9059	2 5/8"	3/16"
9061	2"	1/8"
9080	2 3/32"	5/32"
9252	1 13/16"	3/16"
9267	1 7/8"	3/16"
9268	2 7/32"	5/32"

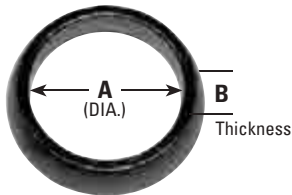

GASKET NO.	A	B
8406	2 9/16"	1 1/16"
8410	1 1/2"	1/2"
8411	2 3/8"	37/64"
8415	2 3/8"	1 1/16"
8423	2 3/16"	1 1/16"
8425	2 31/32"	45/64"
8427	2 9/32"	1/2"
8434	1 23/32"	3/8"
8443	1 31/32"	9/16"

GASKET NO.	A	B
8458	1 59/64"	15/32"
8460	2 27/32"	1/2"
8473	2 17/32"	9/16"
8482	1 25/32"	21/32"
8489	1 15/16"	7/16"
8490	2 13/32"	27/64"
8706 <sup>1</sup>	1 25/32"	1/2"
9002	2 3/16"	5/8"
9003 <sup>2</sup>	2 1/32"	19/32"
9019	2 1/8"	5/8"
9056 <sup>2</sup>	2 1/8"	1/2"
9082 <sup>1</sup>	2 13/16"	19/32"
9084 <sup>2</sup>	2 1/8"	3/4"
9087 <sup>1</sup>	2"	1/2"
9090 <sup>1</sup>	2"	5/8"

GASKET NO.	A	B
9094 <sup>1</sup>	1 3/4"	9/16"
9095 <sup>1</sup>	2 5/16"	5/8"
9215	1 29/32"	21/32"
9216	2 3/8"	5/8"
9221 <sup>1</sup>	2 1/4"	1/2"
9225 <sup>3</sup>	2 5/16"	1 1/16"
9231 <sup>3</sup>	2"	9/16"
9236 <sup>1</sup>	1 11/16"	5/8"
9240 <sup>1</sup>	1 11/16"	1/2"
9248 <sup>3</sup>	2 1/2"	15/32"
9257	2 5/32"	21/32"
9264 <sup>1</sup>	2 1/16"	5/8"
9290 <sup>1</sup>	1 29/32"	5/8"

<sup>1</sup> Graphoil Material  
<sup>2</sup> Sintered Iron Material  
<sup>3</sup> Metal Mesh Material

## EXHAUST GASKET CHARTS

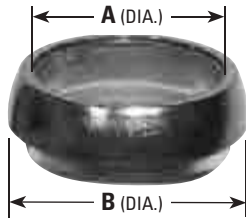

GASKET NO.	A	B
8408	2 5/16"	3 1/8"
8418	2 17/32"	3 7/16"
8444	2 5/16"	3"
8698 <sup>2</sup>	2 1/8"	2"
8699 <sup>2</sup>	2 1/8"	2"
8763	2 1/8"	2 1/8"
8769	1 29/32"	1 7/8"
9051	2 3/8"	2 5/8"
9052	2 1/8"	2 3/8"
9091 <sup>1</sup>	1 11/16"	1 7/8"
9093 <sup>3</sup>	1 15/16"	2 1/4"
9212	1 27/32"	2"
9220 <sup>3</sup>	1 3/4"	2"
9234	2 1/16"	2 13/32"
9259	2"	2 1/2"
9260	2 3/8"	3 3/16"
9261	2 1/4"	2 1/2"
9272	2 1/8"	2 1/2"

<sup>1</sup> Graphoil Material  
<sup>2</sup> Sintered Iron Material  
<sup>3</sup> Metal Mesh Material

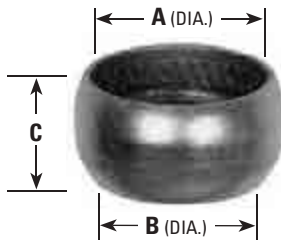

GASKET NO.	A	B	C
8435	2 1/2"	2"	1 1/4"
9292	2"	1 5/8"	3/8"

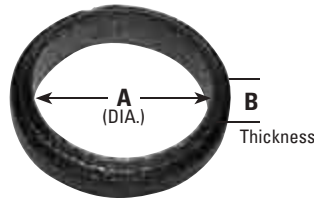

GASKET NO.	A	B
8420 <sup>2</sup>	2 1/4"	9/16"
8440	1 13/32"	5/8"
8715	1 7/8"	5/8"
8717	2 1/32"	5/8"
8738	2 1/2"	5/8"
8740 <sup>2</sup>	1 13/16"	9/16"
8744	2 1/8"	3/4"
8766 <sup>2,3</sup>	2 1/8"	3/4"
8767 <sup>3</sup>	2 3/8"	7/8"
8773	2 1/4"	5/8"
9001	1 7/8"	9/16"
9004	1 25/32"	5/8"
9005	1 31/32"	9/16"
9007	2 1/32"	3/4"
9008	1 15/16"	9/16"
9017 <sup>2,3</sup>	2 9/32"	15/32"
9038 <sup>3,4</sup>	1 3/4"	3/8"
9055	1 3/4"	5/8"
9057 <sup>3,4</sup>	1 5/8"	3/8"
9083 <sup>3,4</sup>	2"	1/2"
9086 <sup>2</sup>	2 7/32"	5/8"
9118	2 9/16"	1/2"
9217 <sup>2,3</sup>	2 13/32"	13/16"
9295	1 13/16"	3/8"
9743 <sup>2</sup>	2 3/4"	5/8"

<sup>2</sup> Sintered Iron Material  
<sup>3</sup> For Spherical Flare Use  
<sup>4</sup> Formed Metal Material

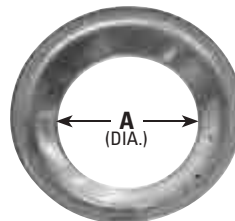

GASKET NO.	A
9244♦	1 9/16"

♦ Copper

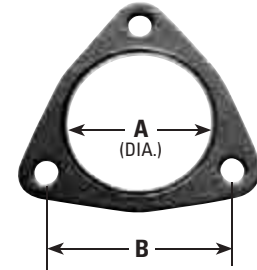

GASKET NO.	A	B
8403	3 9/32"	4 15/32"
8441	2 3/8"	2 3/4"
8442	3 5/32"	3 3/8"
8681	2 5/8"	3 3/16"
8691	2 7/16"	3 9/32"
8705+	2 1/16"	2 15/16"
8710	2 3/32"	2 3/4"
8711	2 9/16"	3"
8720	2 3/32"	2 3/4"
8730	2 11/32"	2 13/16"
8739	1 13/16"	2 5/8"
9000	2 3/16"	3 1/2"
9010	2"	2 33/64"
9018	2 19/32"	3 1/2"
9028	1 13/16"	2 3/8"
9030	1 7/8"	2 5/8"
9031	2 1/4"	2 7/8"
9039	2 13/16"	3 1/4"
9040	2 13/16"	3 5/16"
9042	2 31/32"	3 1/8"
9068	2 1/8"	3 7/8"
9214	1 13/16"	3 29/32"
9278	2 5/32"	2 15/16"
9280	3 1/16"	4 7/16"
9283	2 5/16"	3 1/8"
9287	2 13/16"	4 5/16"

+ Slotted Bolt Hole

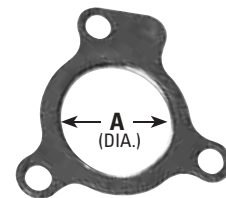

GASKET NO.	A
9047	1 13/16"
9247	2 1/32"
9251	1 15/16"



### EXHAUST GASKET CHARTS

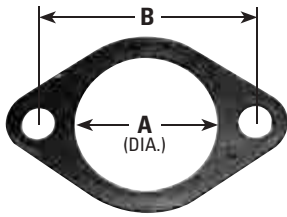

GASKET NO.	A	B
8405	2 1/4"	4"
8412 <sup>5</sup>	2 19/32"	4 3/32"
8426	2 1/4"	4 1/32"
8428+	2 5/64"	3 1/2"
8430+	1 13/16"	3"
8454+	2 19/64"	3 7/8"
8455+	2 13/32"	3 3/8"
8456+	2 19/32"	3 5/16"
8459+	2 5/32"	3 1/8"
8688	2 13/32"	3 15/16"
8689	2 3/8"	3 5/8"
8692	2 1/8"	4"

GASKET NO.	A	B
8697	2"	3 3/8"
8703+	1 49/64"	3"
8704+	2"	3 1/8"
8707+	1 7/8"	3 3/4"
8714	1 31/32"	2 15/16"
8719	1 15/16"	3 1/8"
8722	1 31/32"	3 1/4"
8724	2 5/16"	3 1/2"
8726	2 3/16"	3"
8729	2 9/16"	3 11/16"
8735#	1 13/16"	3 1/8"
8735S	1 13/16"	3 1/8"
8741	1 31/32"	3 3/8"
8742	2 15/32"	3 7/8"
8751	1 13/16"	3"
8768	2"	3 1/2"
8771+	2 1/2"	4"
8772+	2 5/16"	3 1/2"
9033	1 13/16"	2 13/16"
9064	1 27/32"	2 59/64"

GASKET NO.	A	B
9072	2 1/16"	3 5/32"
9075	2"	3"
9079+	2 5/8"	4 1/4"
9081	2"	3 3/16"
9088	1 27/32"	5 1/4"
9099	2 1/2"	4 1/8"
9238	2 1/4"	3 1/2"
9250	2 1/16"	4 5/16"
9256	2 3/8"	4 5/16"
9258+	1 13/16"	3 3/8"
9270	2 21/32"	4 1/16"
9274	2 3/16"	4 1/8"
9275	2 1/4"	3 7/8"
9277	1 15/16"	3 5/8"
9279	2 1/4"	3 5/8"
9284	3 1/16"	5 5/32"
9288	2 23/32"	4 7/16"

+ Slotted Bolt Hole  
# Bulk Packed 10/Box  
<sup>5</sup> Tin Plate With Insert

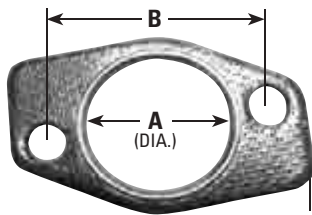

GASKET NO.	A	B
8407	1 27/32"	2 15/16"

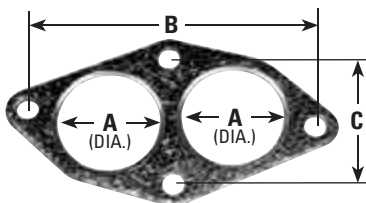

GASKET NO.	A	B	C
9265	1 11/16"	5"	2 3/8"

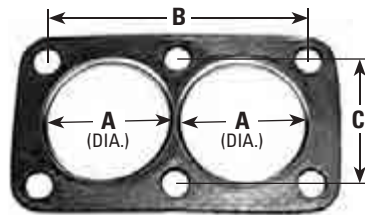

GASKET NO.	A	B	C
9213*	2 3/32"	5 1/16"	2 3/4"

\* Hi-temp Graphite

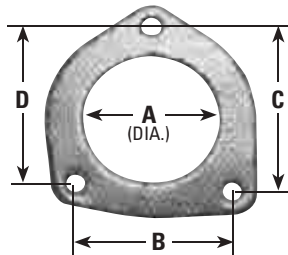

GASKET NO.	A	B	C	D
8414	2 9/16"	2 13/16"	3 9/16"	3 3/8"

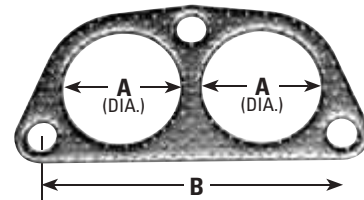

GASKET NO.	A	B
8402	1 13/16"	5 1/8"
8404	2 1/32"	5 5/16"
8463	2"	5"
8696	1 3/4"	4 3/16"
8734	1 11/16"	4"
9022	1 27/32"	4 13/32"
9228	1 7/8"	4 5/16"
9229	2"	4 3/4"
9237	1 1/2"	3 15/16"
9253	1 3/4"	4 5/16"
9255@	1 9/16"	4 3/4"
9281	1 15/32"	3 7/8"
9286+	2 9/16"	7 1/16"

@ Holes Connect  
+ Slotted Bolt Hole

## EXHAUST GASKET CHARTS

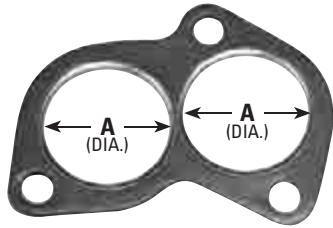

GASKET NO.	A
8750	1 3/16"
9235+	2"

+ Slotted Bolt Hole

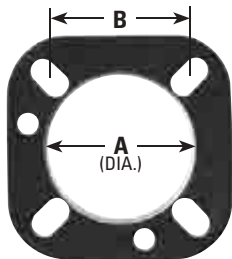

GASKET NO.	A	B
9069	2 29/32"	2 15/16"
9070	3 3/8"	3 7/16"

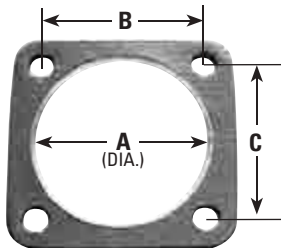

GASKET NO.	A	B	C
8481	3"	3 1/4"	3 1/4"
8759	3 3/32"	2 29/32"	4 31/64"
9025	2 15/16"	2 3/8"	2 3/8"
9058	2 3/4"	2 1/2"	2 3/4"
9226	2 1/2"	2 13/16"	2 1/2"
9227	2 3/4"	3 1/16"	2 11/16"
9289	2 5/8"	3 1/4"	3 1/4"

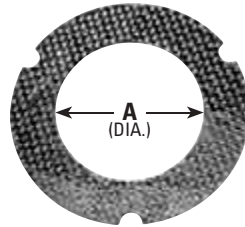

GASKET NO.	A
9223	2 5/8"

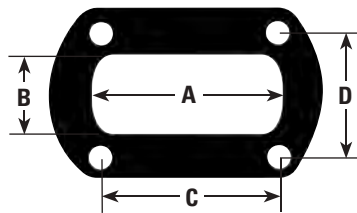

GASKET NO.	A	B	C	D
9245	5 9/16"	2 5/16"	4 9/16"	4 1/4"

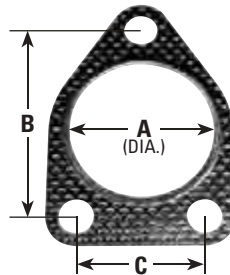

GASKET NO.	A	B	C
8439	2 1/2"	4"	2 43/64"
8453	2 1/4"	3 3/32"	2 23/32"
8701+*	2 1/16"	2 7/8"	2 1/2"
8760	1 13/16"	3 1/4"	2 1/2"
9043	2"	3 1/8"	2 5/16"
9097	2 3/32"	2 15/16"	1 13/16"
9098	1 3/4"	2 13/16"	1 9/16"
9239	2 1/4"	3 3/16"	1 15/16"
9269	2 5/8"	3 5/8"	2 5/16"

+ Slotted Bolt Hole

\* Hi-temp Graphite

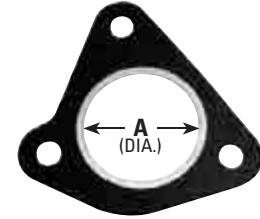

GASKET NO.	A
8712	2 3/32"

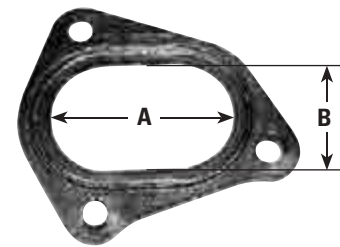

GASKET NO.	A	B
9263	3 7/16"	2 3/16"

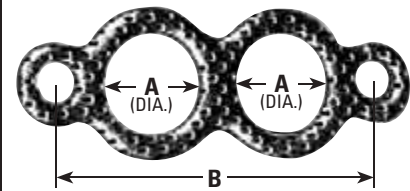

GASKET NO.	A	B
9224	1 5/16"	3 5/16"

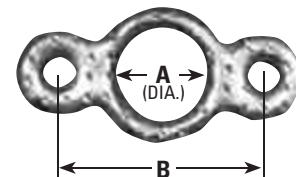

GASKET NO.	A	B
9242	1 3/16"	1 3/4"

### EXHAUST GASKET CHARTS

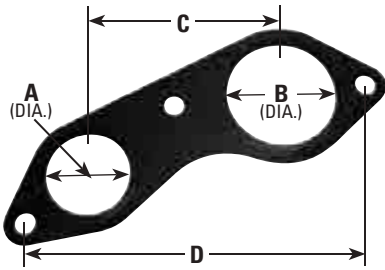

GASKET NO.	A	B	C	D
4731	3 5/32"	3 23/32"	5 5/8"	9 15/16"
9285	2 1/16"	2 3/4"	5 1/4"	9 5/32"

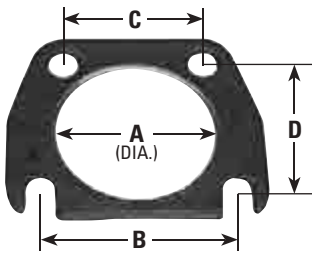

GASKET NO.	A	B	C	D
8682	2 1/16"	2 11/16"	1 15/16"	2 3/16"
9014	2"	3 3/16"	2 3/8"	2 5/8"
9015	2 5/8"	3 3/16"	2 3/8"	2 5/8"

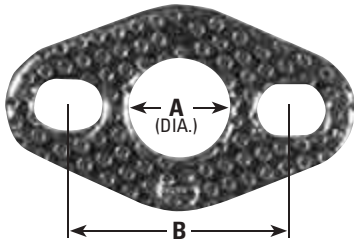

GASKET NO.	A	B
9291+	3/4"	1 11/16"
9299	3/4"	2 1/8"

Airtibe / O2 Sensor Gasket

+ Slotted Bolt Hole

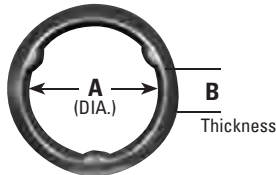

GASKET NO.	A	B
9048	1 27/32"	17/32"
9297	2"	9/16"

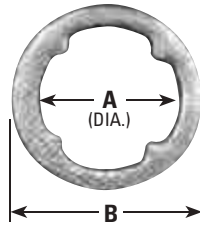

GASKET NO.	A	B
9266	2 9/16"	3 1/2"

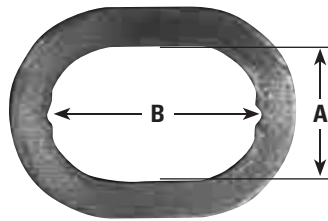

GASKET NO.	A	B
8725	2 7/32"	3 3/8"

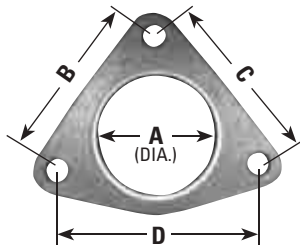

GASKET NO.	A	B	C	D
8468	2 9/16"	4 29/32"	4 29/32"	4 1/2"
9276	2 7/16"	3 1/2"	3 1/2"	4 1/4"

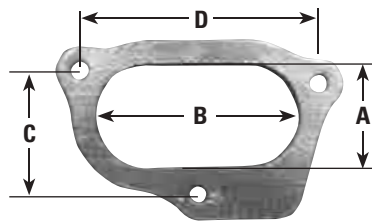

GASKET NO.	A	B	C	D
8708+	2 17/32"	3 29/32"	3 3/8"	4 3/4"
9271	2 11/32"	4 3/4"	2 15/16"	5 9/16"

+ Slotted Bolt Hole

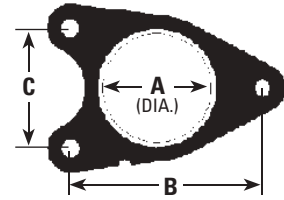

GASKET NO.	A	B	C
8728	2 3/4"	5 3/16"	3 1/8"

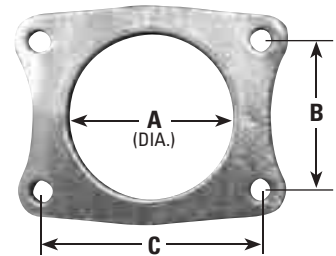

GASKET NO.	A	B	C
9119	3 1/2"	3 1/4"	4 57/64"

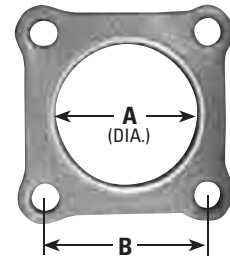

GASKET NO.	A	B
8417	3 9/16"	3 7/32"
8433	4"	3 7/8"
9011	2 11/32"	2 13/16"

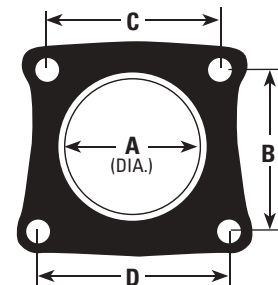

GASKET NO.	A	B	C	D
8721	2 5/8"	2 45/64"	3 21/32"	4 9/64"

## EXHAUST GASKET CHARTS

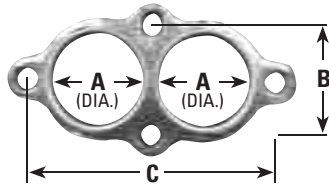

GASKET NO.	A	B	C
8401	1 27/32"	2 1/4"	5 1/8"

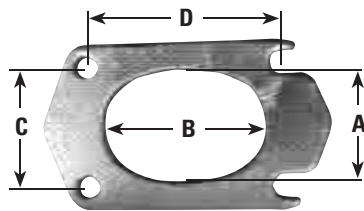

GASKET NO.	A	B	C	D
8761	2 1/2"	3 3/16"	2 3/4"	4 3/8"

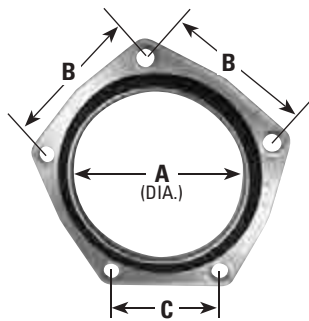

GASKET NO.	A	B	C
8413 <sup>5</sup>	3 21/32"	3 1/16"	2 17/32"

<sup>5</sup> Tin Plate With Insert

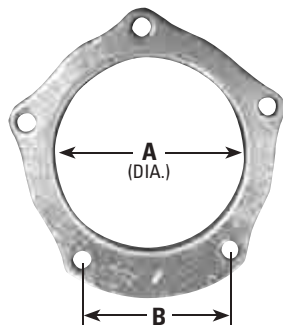

GASKET NO.	A	B
8409	4"	2 7/8"
8465	3 1/2"	3"
8723	3 17/32"	2 13/16"
9096	4 19/32"	3 3/16"
9254	4 1/16"	3 1/8"

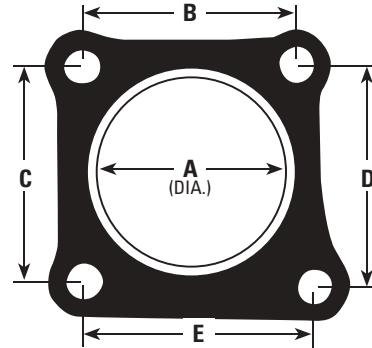

GASKET NO.	A	B	C	D	E
9013	2 1/2"	3 1/4"	3 1/4"	3 1/2"	3 5/8"

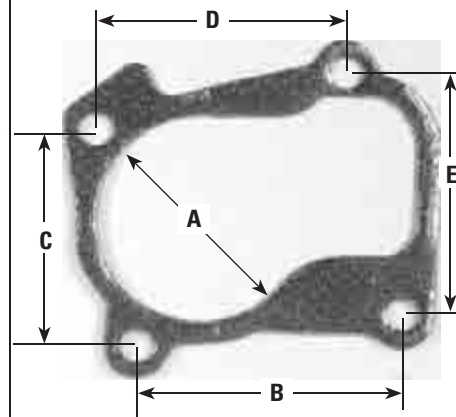

GASKET NO.	A	B	C	D	E
8687	2 1/4"	3"	2 1/2"	2 7/8"	2 49/64"

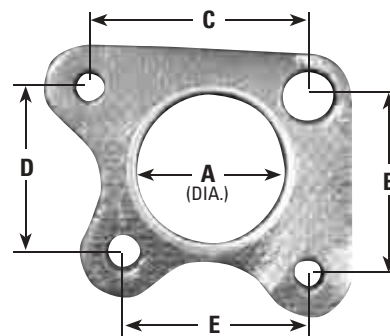

GASKET NO.	A	B	C	D	E
8732	2 1/62"	2 15/32"	3 1/16"	2 1/4"	2 17/32"

### EXHAUST GASKET CHARTS

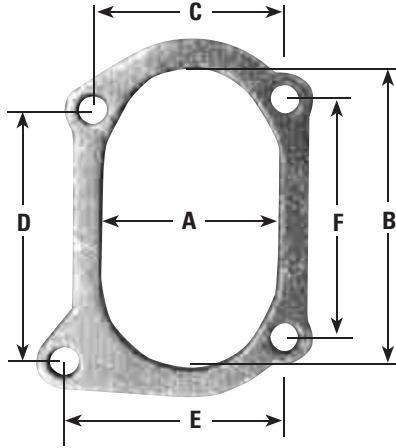

GASKET NO.	A	B	C	D	E	F
8713	2 19/32"	4 15/32"	2 7/8"	3 13/16"	3 5/16"	3 5/8"

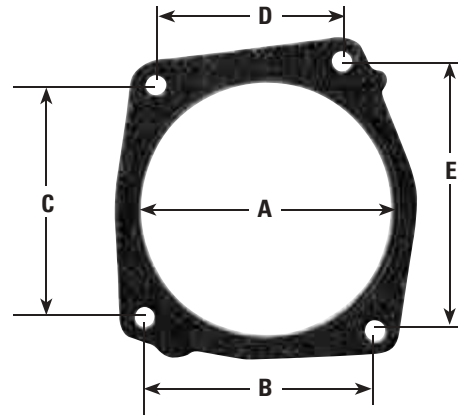

GASKET NO.	A	B	C	D	E
8452	4 43/64"	4 1/4"	4 1/4"	3 1/2"	5"

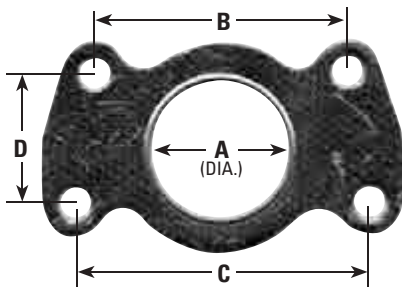

GASKET NO.	A	B	C	D
9054	2"	3 3/4"	4 5/16"	1 15/16"

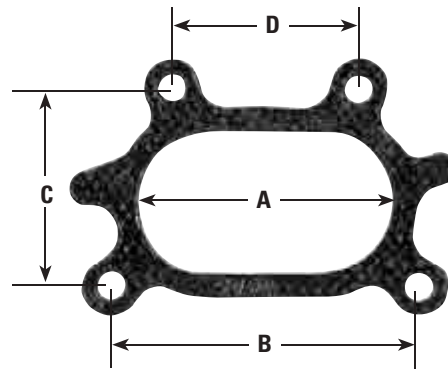

GASKET NO.	A	B	C	D
8480	3 1/4"	3 15/16"	2 1/2"	2 3/8"

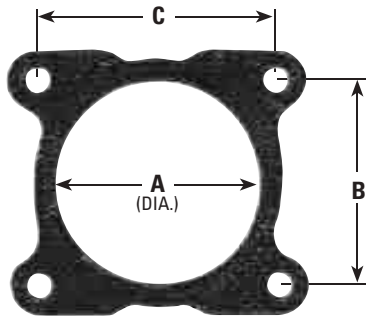

GASKET NO.	A	B	C
8436	3"	3"	3 1/2"

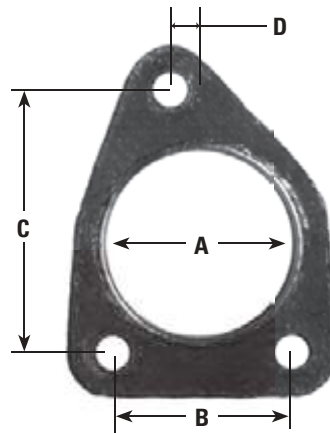

GASKET NO.	A	B	C	D
8685	2 1/4"	2 7/32"	3 3/16"	3/8"

**EXHAUST GASKET CHARTS**



**8431**

96-00 Honda Civic CX/DX/LX 1.6L

96-97 Honda Del Sol S 1.6L



**8432**

06-10 Ford Fusion 3.0L, FWD

06-10 Mercury Milan 3.0L, FWD



**8446**

07-09 Kia 3.3L, 3.8L



**8447**

07-09 Kia 3.3L, 3.8L

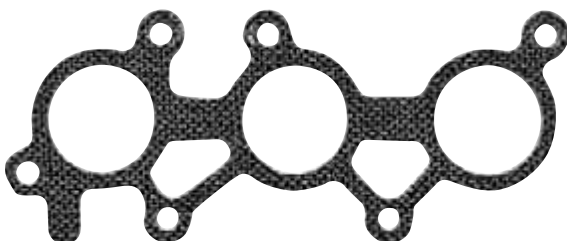

**8471**

07-09 Lexus 3.5L

05-12 Toyota 3.5L



**8472**

07-12 Nissan 2.5L

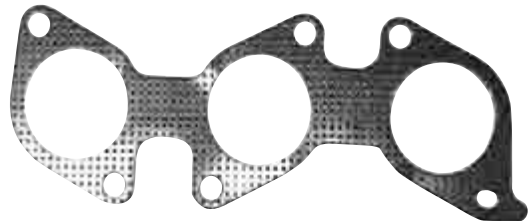

**8475**

03-09 Toyota 4 Runner 4.0L

02-11 Toyota FJ Cruiser 4.0L



**8476**

07-12 GM Colorado/Canyon 3.7L

07-10 Hummer H3 3.7L



**8477**

04-07 Chevrolet Malibu 2.2L

06-07 Pontiac G6 2.4L



**8479**

07-12 GM Colorado/Canyon 2.9L

### EXHAUST GASKET CHARTS



**8486**

09-12 GM Aveo, G3 1.6L, Cruze 1.8L



**8491**

05-10 Hyundai 2.0L

05-09 Kia 2.0L



**8492**

99-10 Hyundai/Kia 2.7L



**8495**

04-06 Infiniti 5.6L

04-12 Nissan 5.6L



**8496**

01-11 Hyundai 1.6L

06-11 Kia 1.6L



**8497**

02-12 Nissan 2.5L



**8499**

99-06 Lexus, Toyota 3.0L

04-10 Lexus, Toyota 3.3L



**8718**

96-12 Ford, Mercury 2.5L, 3.0L

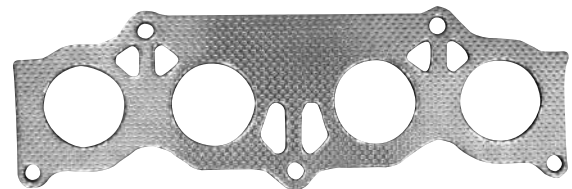

**9243**

05-09 Scion TC 2.4L

08-10 Scion XB 2.4L

02-09 Toyota Camry 2.4L

01-07 Toyota Highlander 2.4L

04-11 Toyota RAV-4 2.4L

02-08 Toyota Solara 2.4L

## CATCO CONVERTER SUPERSESSIONS

OLD PART NO.	NEW PART NO.
1086	1271
1108	1234
1122	1211
1128	1209
1140	1175
1141	1176
1142	1339
1143	1228
1155	1250
1156	1251
1162	1234
1183	1193
1191	1234
1346	1231
4217	4181
4270	4803
4271	5002
4297	5015

OLD PART NO.	NEW PART NO.
4442	5107
4500	4727
4535	4929
4539	1231
4541	5022
4621	4284
4678	9879
5012	5024
9078	9422
9079	9423
9083	9444
9102	9100
9161	9913
9232	5121 + 7511
9254	9998
9273	9912
9500	1291