



CARRICHS ACCESSORIES, LLC.



INSTALLATION GUIDE

FENDER TRIM FOR 2014 - 2015 CHEVROLET SILVERADO 1500
PART #FTCH105, FTCH106, FTCH205, FTCH206, FTCH406

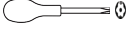
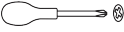
REQUIRED TOOLS:

- Pliers 
- T-15 Torx Screwdriver 
- Phillips Screwdriver* (optional) 

INCLUDED HARDWARE:

- Hooked Clips 
- Clips with holes 
- Phillips Screws* 

FRONT FENDER TRIM INSTRUCTIONS (NO-DRILL):

1. Using a T-15 Torx screwdriver to remove seven (7) T-15 Torx screws (Fig. 1). **Keep** existing T-15 Torx screws and washers for re-install later.
2. Place a correct fender trim (fitment sticker can be found on back of fender trim) over fender to be installed.
3. Slide a "clip with hole" through each slot on fender trim. There are seven (7) clips per front fender trim.
4. Use existing T-15 Torx screws and washers to tighten over "clip with hole".
5. Pull the other end of the clip with a pair of pliers and bend the clip toward the wheel well to secure the fender trim (Fig. 2).
6. Repeat step 1-5 for all seven (7) T-15 Torx screws on each front side.

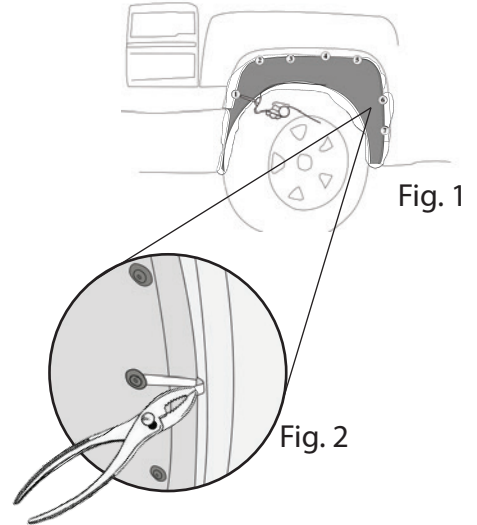

REAR FENDER TRIM INSTRUCTIONS (NO-DRILL):

1. Place a correct fender trim (fitment sticker can be found on back of fender trim) over fender to be installed.
2. Slide a "hooked clip" through each slot on fender trim. There are seven (7) clips per rear fender trim.
3. Pull the other end of the clip with a pair of pliers and bend the clip toward the wheel well to secure the fender trim (Fig. 3).
4. Repeat step 1-3 for all seven clips per rear fender trim

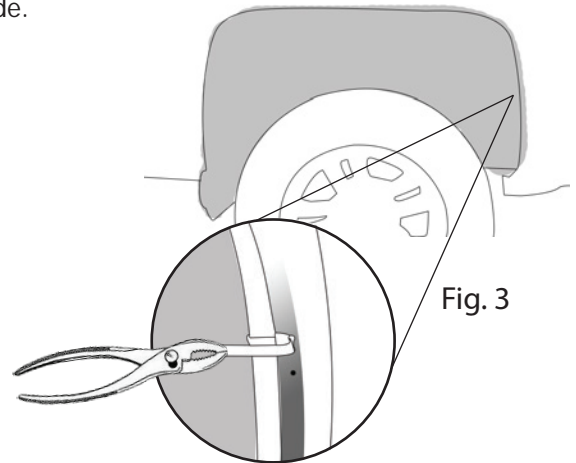

OPTIONAL FENDER TRIM INSTRUCTIONS (DRILL METHOD*):

1. Place a correct fender trim (fitment sticker can be found on back of fender trim) over fender to be installed.
2. Align fender trim properly onto fender and use 7/64 a bit to drill into fender well using the pre-drilled hole on fender trim for guidance (Fig. 4).
3. Use the provided screws to screw the fender trim to the fender using a phillips screwdriver.
4. Repeat step 1-3 for each and every fender trim.

