

A high-angle, top-down photograph of a person wearing a blue long-sleeved shirt, white shorts, and a brown corduroy cap, working on a silver Companion Slider hitch mounted in the bed of a dark-colored truck. The person is positioned on the right side of the frame, leaning over the hitch mechanism. The truck bed has a textured, ribbed surface. The hitch is a complex metal assembly with a large circular component. The text 'COMPANION SLIDER' is overlaid in large, white, bold, sans-serif font across the center of the image. Below it, the text 'YOUR TOWING ADVENTURE BEGINS' is overlaid in a smaller, white, sans-serif font. The background shows a gravel surface at the edge of the truck bed.

# COMPANION SLIDER

YOUR TOWING ADVENTURE BEGINS

An aerial photograph of a deep, rugged canyon with a river winding through its center. The scene is captured at sunset, with a warm orange and yellow glow on the horizon. The canyon walls are layered and textured, showing signs of erosion. The river is a dark blue-grey color, reflecting the sky.

**BW**  
TRAILER HITCHES

*TOWING ADVENTURE*



# DON'T WORRY

## YOUR HITCH WAS MADE RIGHT HERE.

You've got a lot riding on your hitch and the only thing keeping your truck and your trailer connected are those relatively small pieces of engineered steel. The hitch matters to your safety and the safety of our roads.

That's why we treat the manufacture of your trailer hitch with the respect it deserves. For one, we insist on American-made steel, like the sheet steel we buy from U.S. Steel out of Gary, Indiana or the round bar that becomes the gooseneck ball made at a mill in Norfolk, Nebraska. Where the strength and flexibility of the steel can mean life or death, we trust the U.S. steel mills with their finely controlled processes and specifications we can trust.

A hitch is only as good as the welds holding it together. We insist on making those welds under our roof. And the hard-working, skilled Americans that make the welds do so according to the American Society for Testing and Materials Welding Standards.

Thank you for putting your trust in us.

**- Joe Works**

**WELCOME TO THE FAMILY.**

---

**YOU MADE A GREAT CHOICE.**



# SIMPLE GOALS:

MAKE IT SAFE,  
MAKE THE RIDE SMOOTH,  
AND MAKE IT REMOVABLE.



Cam action latching handle  
for easy release, even when  
parked on unlevel sites

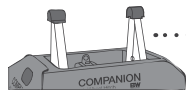

Polyurethane bushings  
provide a quiet, rattle-free  
towing experience

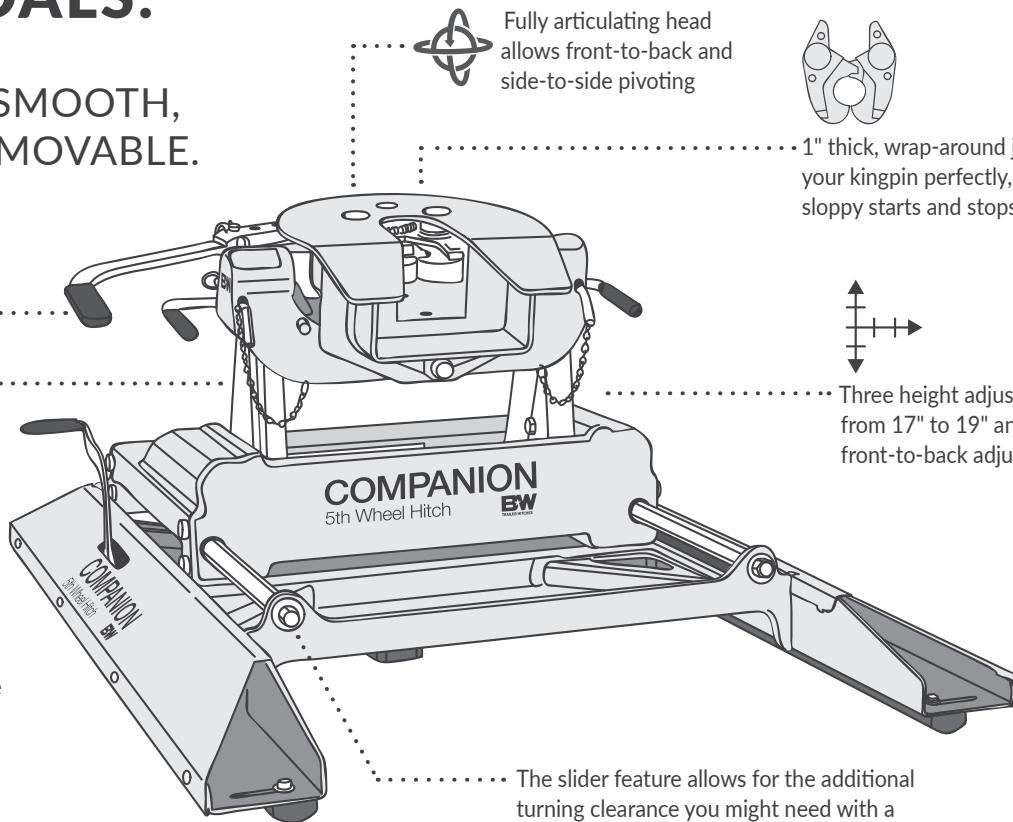

Fully articulating head  
allows front-to-back and  
side-to-side pivoting

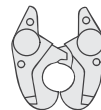

1" thick, wrap-around jaws fit  
your kingpin perfectly, eliminating  
sloppy starts and stops



Three height adjustments  
from 17" to 19" and 2" of  
front-to-back adjustment

The slider feature allows for the additional  
turning clearance you might need with a  
short-bed truck.

# THE B&W DIFFERENCE

Our jaws are a full inch thick cast material and the left and right jaw are machined together to create a precise connection to your kingpin. Then the jaws are wired together, plated, and assembled as a pair. Learn more about this process on the B&W Trailer Hitches' YouTube channel.

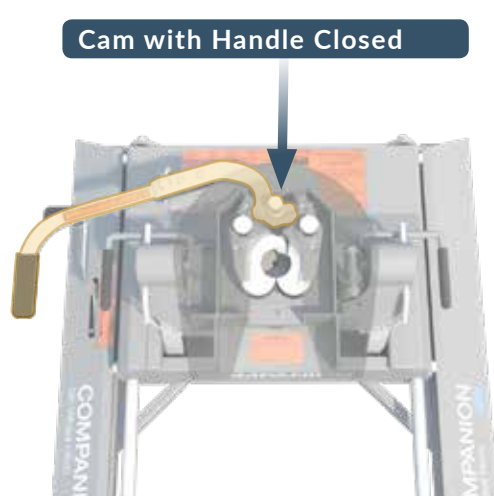

We designed our jaws and handle to work with a cam mechanism. When the handle is pinned closed, the cam keeps the jaws from opening.

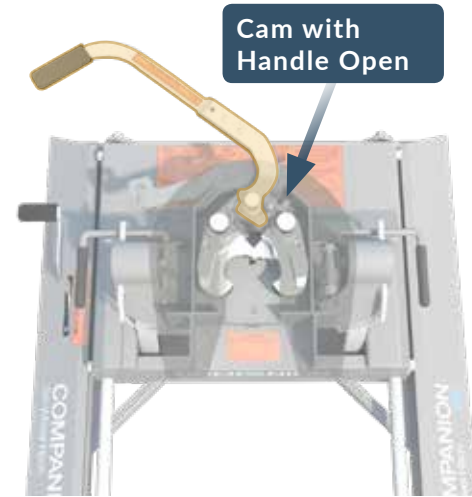

When the handle is open the cam allows the jaws to open, **even if you are in a bind** because of unlevel ground. If the handle is open, you may go ahead and drive out of the jaws. They will open as you pull away.

# ABSORBING THE SHOCK

The Companion allows side-to-side movement and articulation when you are maneuvering or on uneven ground.

The shock absorber, located on one side of the coupler, cushions that movement and allows gentle side-to-side movement without the slamming. Sit back and enjoy the ride.

## JUST HOW TIGHT ARE OUR PROCESSES?

Machining on the jaws must be  $\pm .002$  of an inch. (A piece of paper is about twice that thick.)

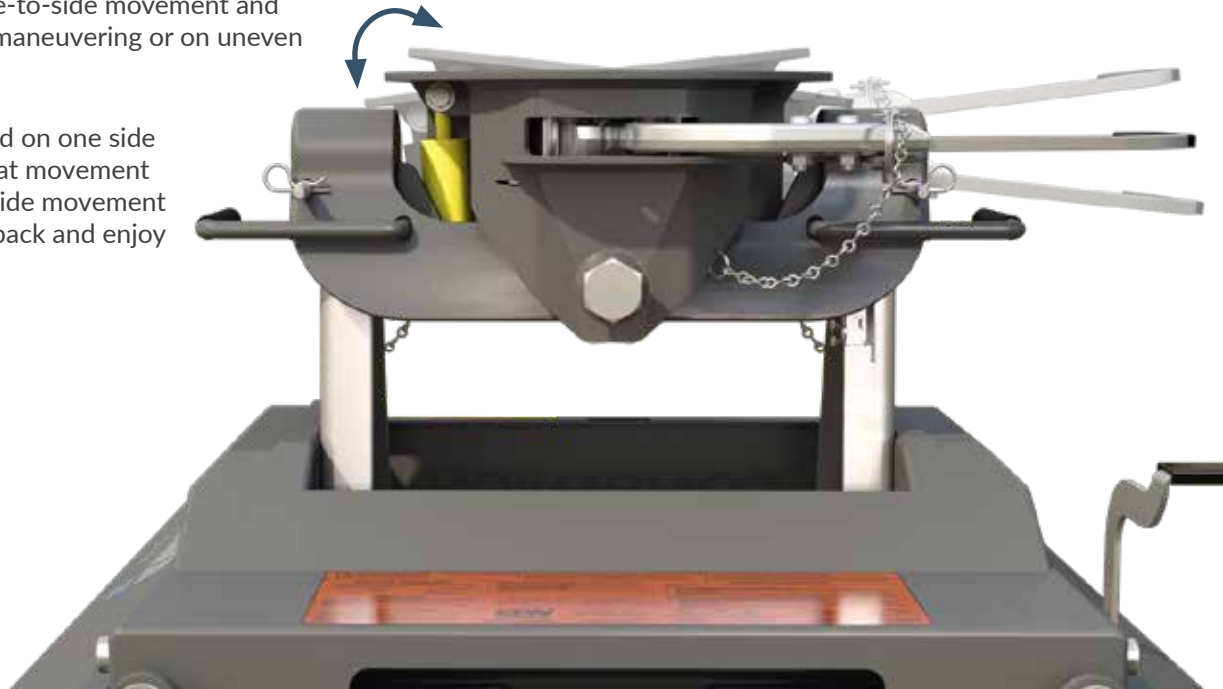

# ADJUST ARMS FOR PROPER CLEARANCE





## INSTALLING PIVOT ARMS

Mount the pivot arms using one of the six different locations illustrated. These six locations allow flexibility in coupler height (vertical adjustment) and distance from the cab (horizontal adjustment). Choose a location so that your trailer will be as level as possible.

### WARNING! - DO NOT USE A WEDGE.

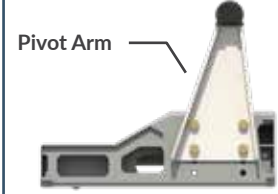

Preventing the kingpin from rotating within the jaws of the Companion coupler with a wedge, or any other device, such as Reese Sidewinder® or Reese Revolution®, could result in property damage, serious injury or death.

		Horizontal Adjustment	
		FORD/GM PUCKS	RAM PUCKS
		Kingpin 3" in front of axle	Kingpin 1" in front of axle
		Kingpin 2" in front of axle	Kingpin over axle
		Kingpin 1" behind post	Kingpin 3" behind post
Vertical Adjustment	Highest Position (19")		
	Medium Position (18")		
	Lowest Position (17")		





## **WATCH YOUR CAB**

Check that you know how sharply you can turn before encountering your cab with your fifth wheel. There are several factors that affect this angle including: the pin box location, the width of trailer, and the shape of the trailer nose.



## **WATCH YOUR BED SIDES**

Check for clearance between your fifth wheel and the sides of your truck bed. Allow several inches so that uneven ground doesn't cause contact. Adjust the Companion to a higher position or your kingpin (if it is adjustable) to a lower position to affect this distance.

# INSTALLING THE SINGLE POINT COMPANION SLIDER

1. Ensure the slider base handle is in the locked position. Disengage the latch pin in the wheel well of the driver's side of the truck by pulling towards you and then to the left.

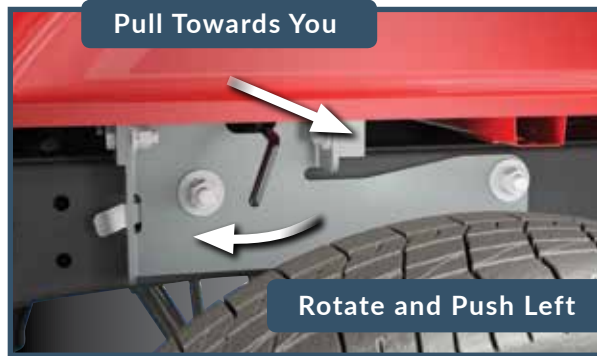

2. Remove the ball or plug from the receiver in the bed. Adjust the plastic feet for your bed ribs. Then place the base, with the post installed, in the receiver. Engage the latch pin fully.



3. Tighten the drawdown bolt on the top of the square post to 80 ft-lbs.

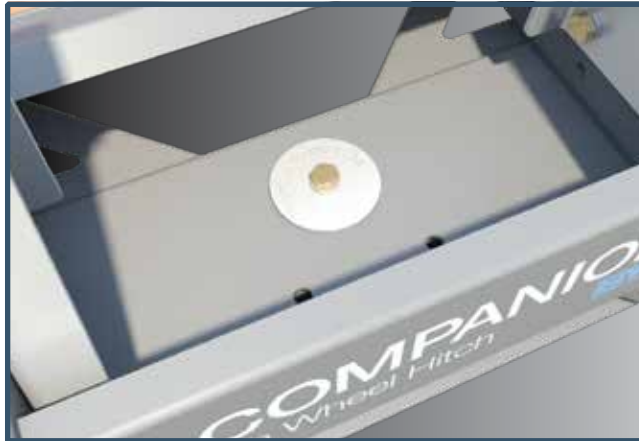

4. Place the coupler on the pivot arms and pin in place.



Place the Coupler on Pivot Arms

# REMOVING THE SINGLE POINT COMPANION SLIDER

1. Ensure the slider base handle is the locked position. Unpin and remove the coupler head.



2. Loosen the drawdown bolt.

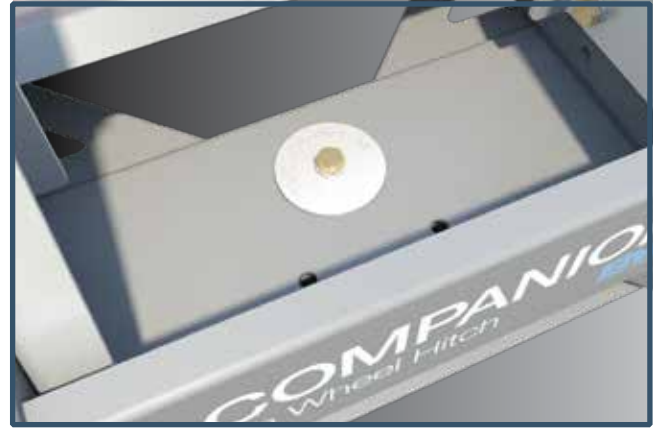

- 3.** Disengage the latch pin in the driver's side wheel well by pulling towards you and then to the left.

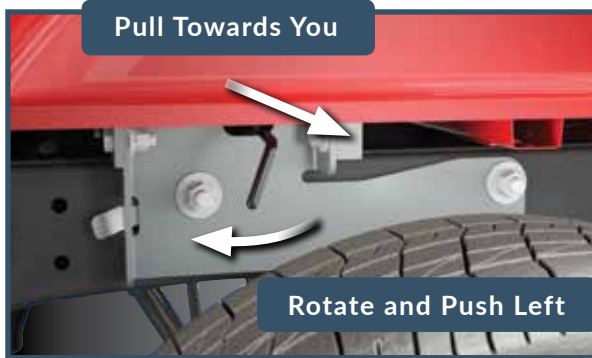

- 4.** Remove the base. Use the ball, in the inverted position, to fill the receiver hole when not towing.

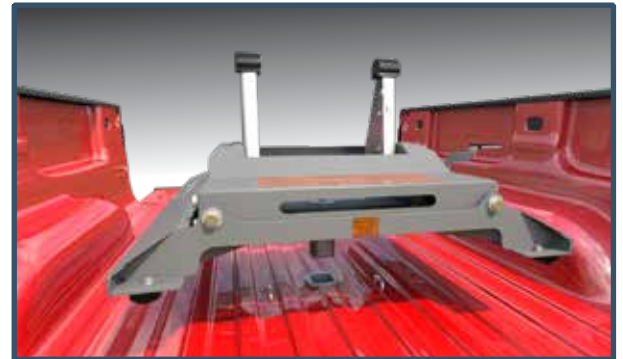

# INSTALLING THE OEM COMPANION SLIDER

1. Ensure the slider base handle is in the locked position. Remove the latch pins from each handle and rotate the handles out. Place the Companion base over the attachment points and carefully lower it until the latch cams pass through the floor and the base rests flat against the top of the attachment points.



2. Once the base is in place, turn each of the latch handles so the base is drawn firmly down onto the attachment points. You should feel some resistance with turning the handles as the base is drawn down. If any of the handles will not close or if they rotate freely with no resistance, the tension on the latch handles will need to be adjusted.



Place Base in Receiver

**If your handle needs tension adjustment.** With a pair of needle nose pliers, un-bend and remove the cotter pin installed at the top of the latch cam. Then adjust the height of the castle nut.

**To loosen the latch handle** (handle is difficult to rotate or cannot be closed) rotate the castle nut counter-clockwise (loosen) with a 15/16" wrench or socket.

**To tighten the latch handle** (handle rotates without any resistance) rotate the castle nut clockwise (tighten) with a 15/16" wrench or socket.

Use trial and error to find the correct latch tension for each attachment point. After the tension is set, replace the cotter pin and re-bend the ends. You may have to rotate the castle nut slightly to allow the cotter pin to pass through.



3. With the base firmly held down and each latch handle closed, replace the latch pins removed in step one. Place the coupler on the pivot arms and pin in place.



Place the Coupler on Pivot Arms

# REMOVING THE OEM COMPANION SLIDER

1. Ensure the slider base handle is in the locked position. Unpin and remove the coupler head.



2. Remove the latch pins from each of the handles.





- 3.** Turn latch handles to the open position.



- 4.** Lift the base straight up and out of the attachment points.



# KNOW BEFORE TOWING

Your Companion Slider is rated to tow 20,000 lbs. It is important to learn your manufacturer's weight limits (truck, fifth wheel, and hitch). Detailed instructions for comparing these weight limits to the actual weights of your set-up are found on the next few pages.

Truck manufacturers give their trucks specific ratings after extensive testing. Tow ratings are based on the capacity of a truck's engine, transmission and brakes to safely handle the weight of a loaded trailer. For Gross Weight Ratings, the truck's tires, frame, and suspension must be able to bear the load.

Even though your Companion Slider fifth wheel hitch is rated to tow 20,000 lbs., never exceed your truck's weight ratings.

All of our hitches are tested for both strength and durability according to SAE J-2638, the latest standard for fifth wheel and gooseneck hitches.



Without proper knowledge, towing can be a dangerous activity. If you are new to towing, we recommend

***"The Trailer Handbook:  
A Guide to Understanding  
Trailer and Towing Safety"***

from the National Association  
of Trailer Manufacturers.

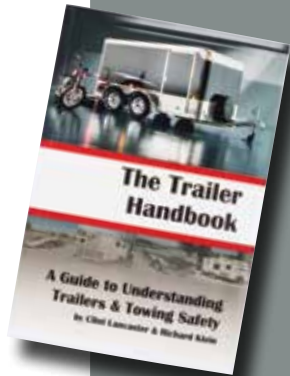



# FINDING MANUFACTURER WEIGHT LIMITS

Locate your **Gross Vehicle Weight Rating (GVWR)**.

This is the maximum allowable weight of the fully loaded vehicle.

You can find this, most likely, on the sticker inside your driver's side door.

GVWR

You should also locate your **Gross Combined Weight Rating (GCWR)**

from your truck manufacturer. This is the maximum allowable weight of the tow vehicle and the loaded trailer including all cargo and passengers.

Find this in your owner's manual or by calling your truck dealer.

GCWR

And finally, locate your **Max Tow Rating**.

It is sometimes located in the truck owner's manual

Max Tow Rating

B&W recommends that your **Vertical Towing Weight Rating (VTWR)**

for your hitch be no more than 25% of your truck's Max Tow Rating.

Make this calculation:  $\text{Max Tow Rating} \times .25 = \text{VTWR}$

VTWR

Once you have located your truck manufacturer's weight ratings, transfer them into the corresponding boxes on the next two pages.

# FINDING YOUR ACTUAL WEIGHTS

Take your loaded truck and loaded trailer to a scale at a truck stop, quarry or material supply center. For a small fee you can weigh your tow vehicle and trailer on their scale.



	MUST BE MORE THAN	
--	-------------------	--

**GVWR** \*

*your GVW*

## 1. Find your **GVW** (Gross Vehicle Weight)

Weigh just your truck with a full tank of gas, all your passengers and items in the cab and truck bed with your trailer loaded and attached, but not on the scale.

Do Not Exceed Your Truck Manufacturer's **GVWR**



	MUST BE MORE THAN	
--	-------------------	--

**GCWR** \*

*your GVW*

## 2. Find your **GCW** (Gross Combined Weight)

Weigh your fully loaded truck and trailer including all cargo, a full tank of gas and passengers.

Do Not Exceed Your Truck Manufacturer's **GCWR**

\* Transfer Manufacturer's Ratings from previous page.



### 3. Find your **Towing Weight**

Weigh your loaded truck without the trailer attached. This is your truck weight.

Subtract your **Truck Weight** from your **GCW**. This is your towing weight.



**MAX TOW RATING** \*

*your Towing Weight*



### 4. Find your **VTW** (Vertical Tow Weight) also known as Tongue Weight

Subtract your **Truck Weight** from your **GVW**.



**VTWR** \*

*your VTW*

**IMPORTANT!**

Even though you may be under your vehicle's Max Towing Rating, when your Gross Vehicle Weight (GVW) goes up, (more passengers, more cargo) your ability to tow the Max Towing Rating may not be possible, because:

**THE GROSS COMBINED WEIGHT RATING (GCWR) MUST NOT BE EXCEEDED.**

# ATTACHING YOUR TRAILER

1. Remove the coupler cam handle safety pin and use the cam handle to open the coupler jaws.

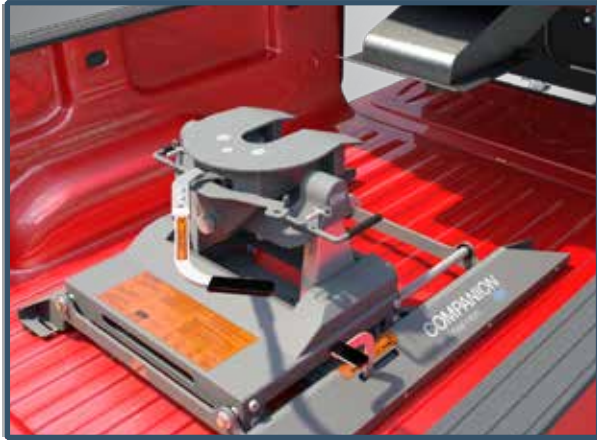

2. Adjust the height of the fifth wheel trailer using the jack so that the kingpin plate is slightly lower than the top of the coupler.
3. Back the truck towards the trailer, centering the trailer's kingpin in the coupler, until the kingpin has engaged the jaws.

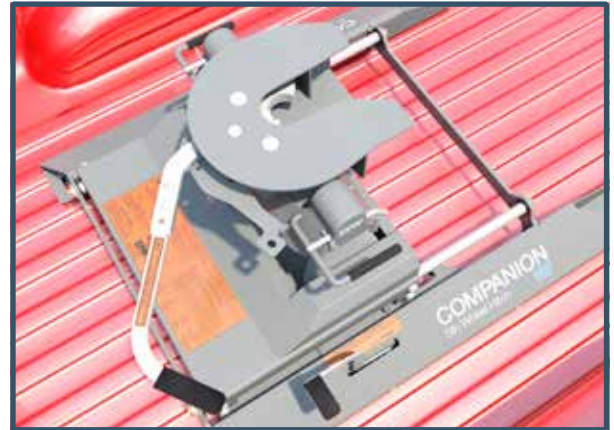

4. Ensure that the coupler cam handle has completely closed and insert the cam handle safety pin through the cam handle and the coupler.



5. Hook up brake and lighting connections before towing.

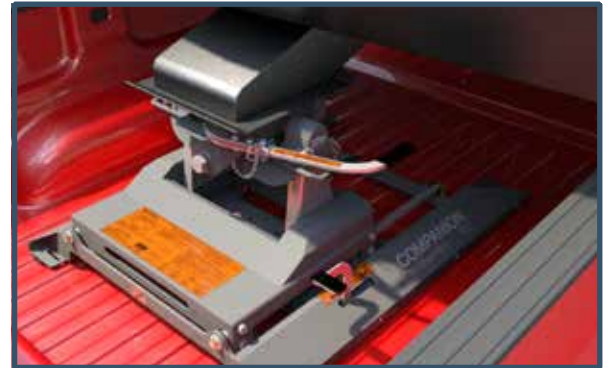

# CONDUCT A SAFETY TEST

Before towing, you should conduct a safety test to make certain that you are properly hitched.

1. Place the truck in 'park', and put the emergency brake on.

The trailer should have wheels blocked:

Wheel Blocks



The trailer's landing gear should be firmly on the ground, supporting the weight of the trailer:

Landing Gear

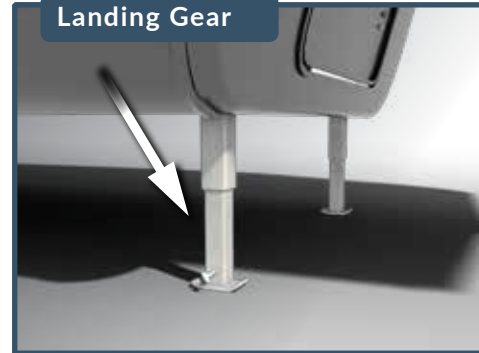





2. Make sure that no one is between the truck and the trailer. Release the emergency brake and apply the trailer brakes.
3. Try to pull the trailer forward with the truck. If the trailer is properly hooked up, the wheel blocks and trailer brakes should not allow the truck to move forward.
4. If the trailer is not hitched correctly, the truck will separate from the trailer. However, with the landing gear resting firmly on the ground, it will support the trailer and not allow it to drop or fall on the truck sides.



# MOVING YOUR SLIDER TO THE MANEUVERING POSITION

1. While the trailer is coupled, set the trailer brakes and/or chock the trailer wheels.
2. Pull the handle towards the rear of the truck to move it to the unlocked position.
3. Pull the truck forward slowly until the handle falls into the locked position.
4. Release the trailer brakes, un-chock the trailer and maneuver the trailer as needed.

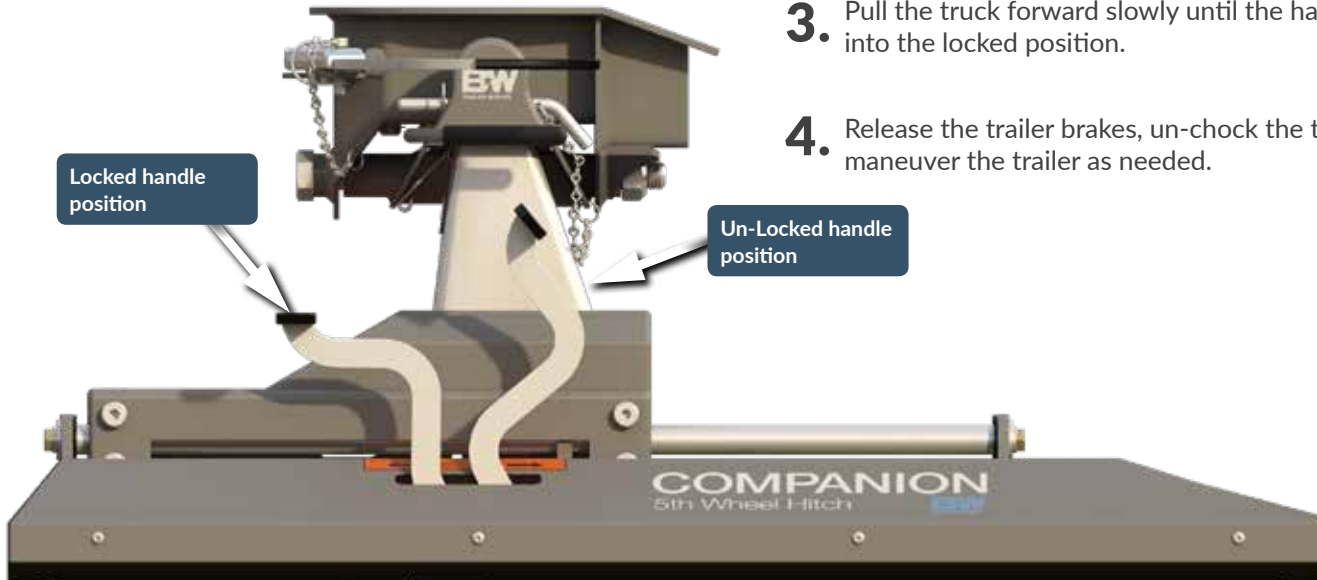

# MOVING YOUR SLIDER TO THE TOWING POSITION

- 1.** Once the trailer is satisfactorily positioned, set the trailer brakes and/or chock the trailer wheels.
- 2.** Pull the handle towards the rear of the truck to move it to the unlocked position.
- 3.** Move the truck slowly in reverse until the handle falls and is in the locked position.
- 4.** Release the trailer brakes and/or un-chock the trailer.

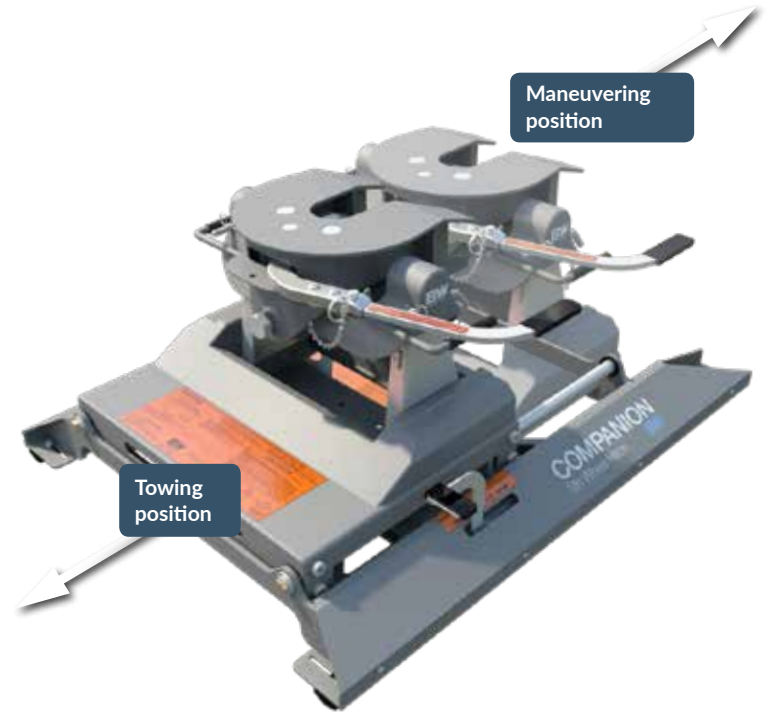

# DISCONNECTING YOUR TRAILER

1. Lower landing gear and chock the trailer wheels.

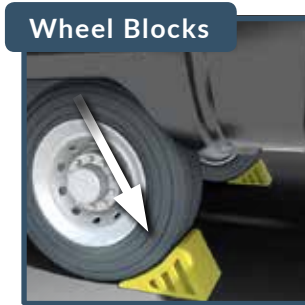

2. Raise the trailer until the tongue weight is removed from the truck.

3. Unpin the coupler handle and rotate to the open position to release the jaws.



4. Use the safety pin to lock the handle in the open position and when you are sure that the landing gear will support the trailer, move the truck forward to release the jaws from the kingpin.
5. If the jaws do not open, that may be an indication that there is still downward pressure on the jaws. Readjusting the landing gear may relieve that pressure. However, if the handle is open, the jaws will always open as you pull away once pressure is relieved.



# HITCH MAINTENANCE

There are four places on the Companion that you should lubricate regularly.

1. Grease the saddle through the grease zerk approximately every six months with multi-purpose grease. This allows the coupler to pivot freely.

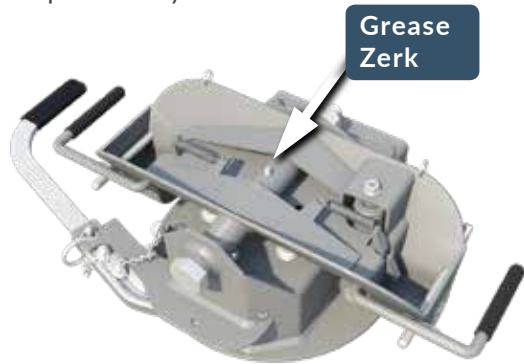

2. Spread a thin layer of multi-purpose grease around the inside surface of the jaws where they grasp the kingpin. You may also want to apply some grease to the kingpin on your trailer.

3. As needed, grease the polyurethane bushings with multi-purpose grease.

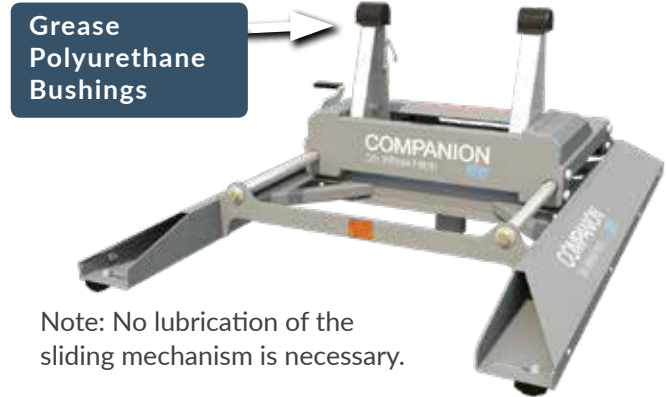

Note: No lubrication of the sliding mechanism is necessary.



# BW™

## TRAILER HITCHES

### MULTI-PURPOSE WHITE LITHIUM GREASE

- Lubricates and Protects
- Water Resistant
- Single Use

## LOVE YOUR HITCH LONGER!

Net Wt. 7 g

4. Lubricate the top surface of the coupler with automotive type chassis grease or use a nylon lube plate to provide a lubricated surface.



## LUBE PLATES

Lube plates come in all sizes. We recommend a 10" version, like this one infused with graphite.





# OUR AMERICAN DREAM STORY

Like many, ours began in a garage in 1987, with two men and an idea. Roger Baker and Joe Works (the 'B' and the 'W') began building custom truck beds and quickly recognized a way to improve the inconvenience of a gooseneck ball permanently welded in the bed. They designed a gooseneck hitch with the mounting hardware underneath the bed and a ball that turned over and stowed where it was used. The Turnoverball® Gooseneck Hitch was born.

A few years later, they applied the same concepts to fifth-wheel hitches. Using the same under-bed mounting hardware and hole in the bed, they designed the Companion® with a single-point attachment that was removable when not towing. They also designed the Companion to be quiet and smooth when towing.

While competitors take manufacturing to China and Mexico, Joe (Roger retired in 1999) remains committed to using American-made raw materials and American Labor.

***“You don’t work for me, you work for the customer. We can compete in this global economy by designing better, using technology, and truly caring about our customers,” Joe affirmed.***

Our product line now includes all types of towing products manufactured under the 383,000 sqft. facility. In 2007, Joe began transferring ownership of the company to us, the now 350 employee-owners.



Looking for dependable trailer hitches & towing? Rely on B&W Trailer Hitches for quality and long-lasting products.