

FORD F-150

Set Part # 20916

STEP 1.

Prior to Installation:

- A) Bushwacker only approves installing the flares according to these written instructions with the hardware provided. **WARNING:** Failure to install according to these instructions will invalidate the warranty. This includes, but is not limited to using alternative installation methods, hardware, or materials. **DO NOT USE:** Loctite, SuperGlue, or similar products on the hardware or the flares.
- B) **Fit:** Verify you have ordered the right flares for your vehicle make and model and check their fit.
- C) **Painting :** (Optional) if paint is desired it must be done prior to installing flares on the vehicle clean outer surface with a good grade degreaser. **DO NOT USE LACQUER THINNER OR ENAMEL REDUCER AS A DEGREASER.** Wipe outer surface thoroughly with a tack rag prior to paint. Paint flares using a high quality enamel, or polyurethane automotive paint. (Application of a primer coat is optional) If painting edge trim (not recommended) use a flex additive.
- D) **Performance:** Using larger Tires may increase the area required to turn the vehicle. Some Tire/Rim combinations may require lowering bump stops and or installing steering stops to prevent tire from contacting flare.
- E) **Exhaust System:** Modifications may be necessary to maintain a minimum 4" clearance between flares and exhaust pipes. (Exhaust gases should not vent directly onto flares)



TOOLS FOR EASY INSTALLATION

- Utility Knife
- #2 Phillips Drive bit
- 7/32 Socket
- T45 Torx Bit
- Socket Wrench
- Marker

FLARE INSTALLATION PROCEDURES

STEP 2: Preparing the Work Area (Front and Rear)

Remove factory fender trim and mud flaps (when installed).

STEP 3: Edge Trim Installation (See Illustration #1)

- A) Peel two to three inches of red vinyl backing away from edge trim tape. Applying the adhesive side of the edge trim to the inner side of the flare, affix the edge trim to the top edge of the flare (the portion that comes in contact with the side of the vehicle).
- B) Press edge trim into place along the top edge of the flare in one-foot increments, pulling red vinyl backing free as you continue to work your way around the top edge of the flare.

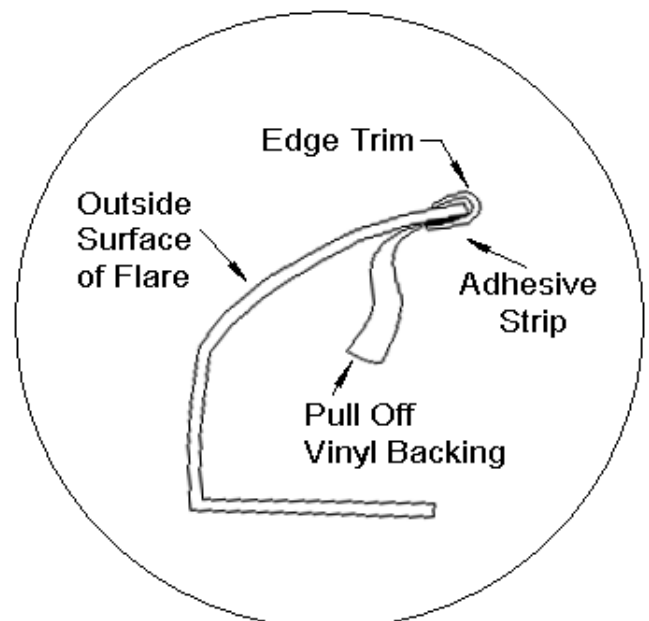

Illustration #1

STEP 4: (Front and Rear Flare) Stainless Steel Screw Installation (See Illustration #2)

- A) Insert a stainless steel screw and washer into each pocket in the front of the flare, and secure with a nyloc nut, using T45 Torx bit. See Illustration #2.

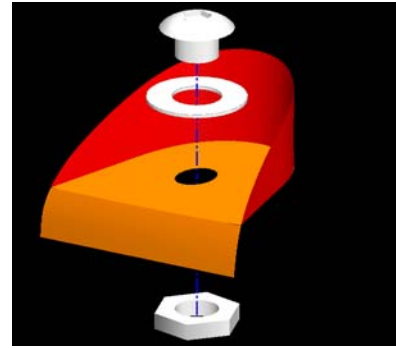

Illustration #2

STEP 5: Front Flare Installation (See Illustrations #3 & #4)

- A) Remove and save the five (5) factory hex screws (located inside the wheel well rim) using a 7/32" socket.
- B) Attach mounting brackets to front flare through top three holes in flare and 1/4" hole in bracket with Tuf-Lok® fasteners. See Illustrations #3 & #4.
- C) Holding flare in place on fender, apply moderate pressure to outside surface of the flare; Fasten using the factory hex screw removed earlier in Step 5A.
- D) *NOTE: Some model years may not have a factory fastener at the top of the wheel well. If this fastener is not present on your vehicle, please refer to the following steps:*
- Pull splash shield back from behind fender. This may require a prying tool.*
 - Slide a supplied U Clip on splash shield as shown in Photo #1 below.*
 - Attach flare as mentioned in Step 5C, using supplied Truss Head Screw instead of the factory fastener. The screw will be inserted into the clip you just installed.*

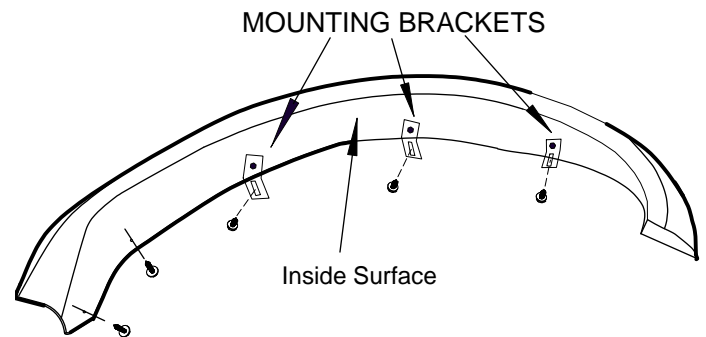

Illustration #3



Photo #1 – Pull splash shield from behind fender. Install a supplied “U” Clip on splash shield as shown.

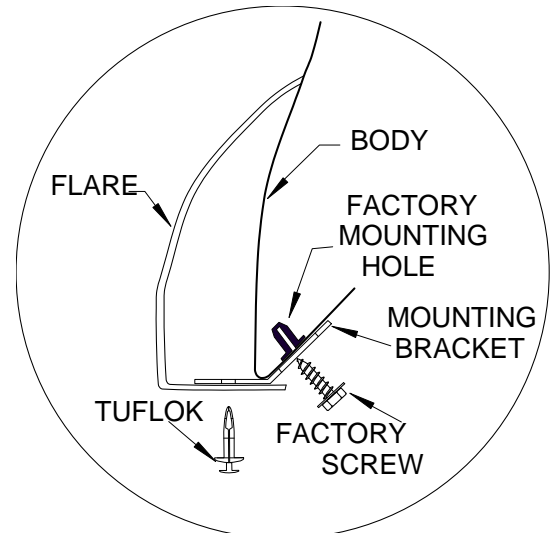

Illustration #4

STEP 6: Rear Flare Installation (See Illustrations #5, #6, & #7)

- E) Hold flare in position with moderate pressure. Using the holes in the flares as a guide, mark wheel well lip where each hole is.
- F) Remove flare and stick a black Mylar tab over each marked location on wheel well lip. Slide supplied clamps over each tab location. **See Illustrations #5, #6 & #7.**
- G) Starting with the two corner holes, start the supplied screws but keep loose.
- H) Ensuring the flare is properly located on fender, install remaining screws. Applying moderate pressure to outside surface of flare, tighten screws, beginning with the two corner locations and then the two bottom screws. Tighten the top center screw last.

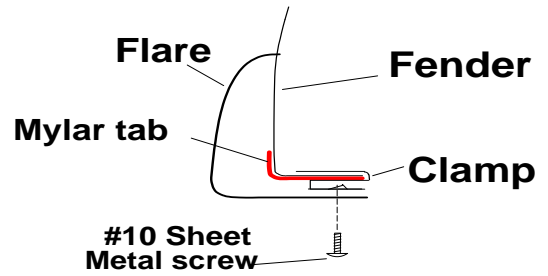

Illustration #5

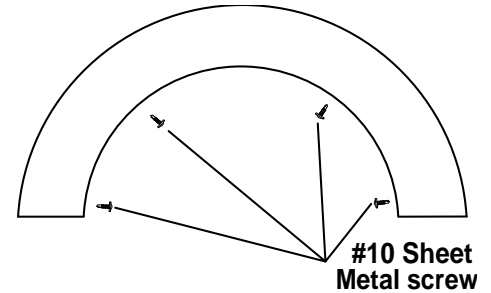
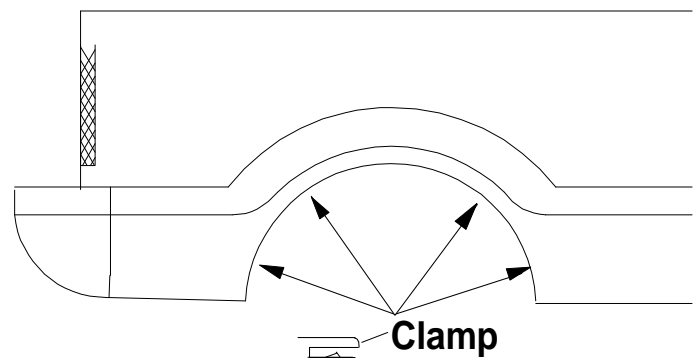

Illustration #6



Rear Flare

Illustration #7