



GMC Sierra Short Bed Bed Rail Cap

Set Part #49522

STEP 1 – PRIOR TO INSTALLATION

- A)** Bushwacker only approves installing the bed rail caps according to these written instructions with the hardware provided. **WARNING:** Failure to install according to these instructions will invalidate the warranty. This includes, but is not limited to, using alternative installation methods, hardware, or materials. **DO NOT USE:** Loctite, SuperGlue, or similar products on the hardware or the parts.
- B) Fit:** Bed rail caps should be held to the vehicle surface to verify correct type and fit *BEFORE* beginning installation or painting. Small fit adjustments can be made by trimming (filing, sanding, or cutting) excess plastic.
- C)** When using this product with other aftermarket accessories, like Tonneau Covers or Toppers, you must allow for lengthwise expansion and contraction of the bed rail cap. You must notch around any clamps or hard fastening points.
- D) Painting:** (Optional) If paint is desired it must be done prior to installation. Sand (optional) before application of paint. Clean outer surface with a good grade degreaser. **DO NOT USE LACQUER THINNER OR ENAMEL REDUCER AS A DEGREASER.** Wipe outer surface thoroughly with a tack rag prior to paint. Application of plastic adhesion promoter for TPO plastic as per your paint system manufacturer's recommendations is required. Paint caps using a high quality enamel, or polyurethane automotive paint. Application of a primer coat is optional.
- E) Preparing the Work Area:** Clean the area of installation with a cloth and rubbing alcohol or prep-solvent to remove any car wax or dirt from vehicle surface.
- F) Ambient Temperature:** During installation the vehicle, bed rail caps, and the tape needs to be between 60°F and 110°F for proper adhesion. Failure to maintain proper installation temperature may result in the part not functioning correctly. If not within acceptable range, increase surface temperature using a heat gun or suitable device (hair dryer) to help reach proper range. The warmer the surface, the better the bond.

ULTIMATE BEDRAIL & TAILGATE CAPS

TOOLS FOR EASY INSTALLATION:

- Clean Cloth
- Rubbing Alcohol
- #2 Phillips Screw Driver

LIMITED LIFETIME WARRANTY AGAINST ANY MANUFACTURING DEFECTS

- To claim a warranty, you must provide Proof of Purchase.

Included in Hardware Kit:

- | | | | |
|----|---|----|---|
| 1. |  | 2. |  |
| | SW1-0050, 10
x 5/16 Truss
Phillips Screw,
4 pcs | | CL1-0006, "S"
Spring Clip,
4 pcs |

Bed Rail Cap Installation

1. Peel the red vinyl backing away from the pieces of tape on the inside of the bed rail cap.
2. Position the bed rail cap snugly at the tail end of the bed rail.
3. Carefully lay the part down on the bed rail (aligning the stake pocket holes in the part with the stake pockets in the truck if applicable) and apply 30 PSI to the taped areas for proper bond. **See Illustration A**
4. Wait one hour, making sure vehicle maintains proper temperature, and apply 30 PSI to the taped areas *AGAIN* for proper adhesion to the vehicle. *NOTE: Tape reaches maximum adhesive bond after 24 hours of contact.*
5. Slide a CL1-0006, "S" Spring Clip, onto the bed rail in the areas where there is a bump on the inside edge of the bed rail cap. **See Illustration B & C**
6. Fasten the bed rail cap to the clips with the SW1-0050, 10 x 5/16 Truss Phillips Screw. **See Illustration B & C**

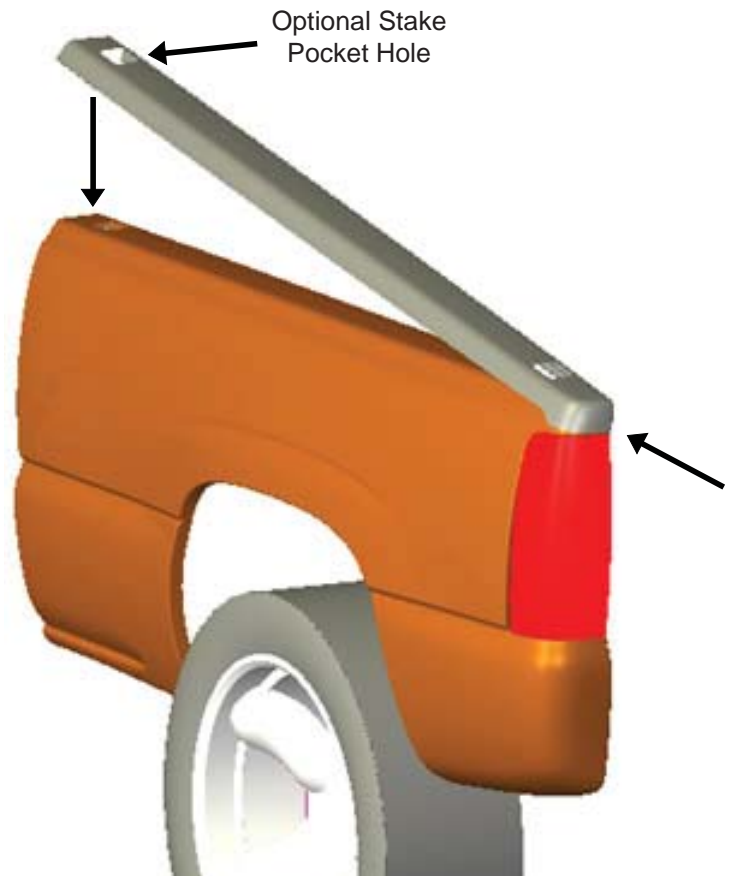

Illustration A

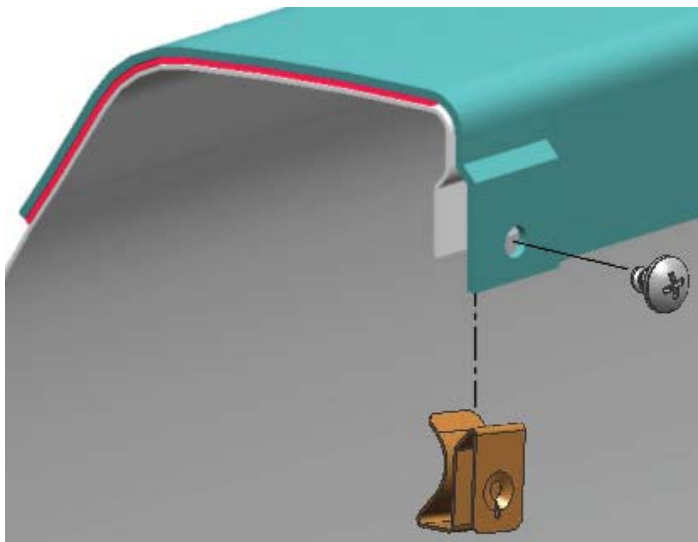

Illustration B

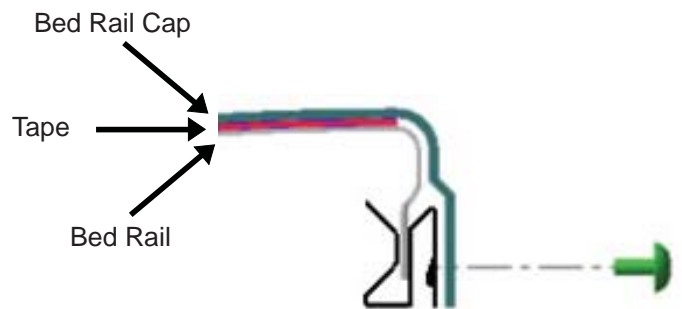

Illustration C