



DC Series Utility Winches Instruction Manual



To prevent **SERIOUS INJURY, DEATH** and **PROPERTY DAMAGE**, you should read, understand and follow the warnings and instructions in this manual. Keep for future reference.

Read, Understand, Follow and Save These Instructions

- Read, understand and follow all of these instructions and warnings before installing and using this product.
- Install and use this product only as specified in these instructions.
- Improper installation or use of this product may result in property damage, serious injury, and/or death.
- Never allow installation or use of this product by anyone without providing them with these instructions.
- You must read, understand and follow all instructions and warnings for any product(s) to which this product is used in conjunction with or installed.
- Save these instructions with the product for use as a reference for any future installation and use of the product.

Throughout this manual **WARNING, CAUTION, NOTICE** and the **SAFETY ALERT SYMBOL** will be used.

 The safety alert symbol alerts you to potential physical injury hazards. Obey all safety messages that follow this symbol to avoid possible injury or death.

 **WARNING**

WARNING indicates a hazardous situation that, if not avoided, could result in death or serious injury.

 **CAUTION**

CAUTION indicates a hazardous situation that, if not avoided could result in minor or moderate injury.

NOTICE

NOTICE indicates a hazardous situation that, if not avoided, could result in property damage

Table Of Contents

	Page
Safety	
Important Safety Messages	3
Know Your Winch	4
Features and Ratings	5
Instructions	
Installation Instructions	7
Operation Instructions	13
Maintenance	16

Important Safety Messages

Before First Operation

- Purchaser/owner must ensure that product is installed according to these instructions. Purchaser/owner must not alter or modify product.



- Understand your winch and its instructions.
- Never exceed maximum rated capacity. Refer to stamped markings or decals on product to obtain rated capacity.
- The winch is rated at the first layer of wire rope on the drum for intermittent-periodic duty.

Are you ready to pull?

- NEVER operate this winch when under the influence of drugs, alcohol or medication.



- ALWAYS remove jewelry and wear eye protection.



- Use leather gloves or a hand saver cable strap when handling the wire rope.
- NEVER let winch rope slip through your hands.
- Never touch a winch rope or hook when someone else is at the controls.
- NEVER touch winch rope or hook while under tension or under load.
- ALWAYS stand clear of winch rope and load and keep others away while winching.



- Do not use the winch as a lifting device or a hoist for vertical lift.
- Operator and bystanders should never position any part of body under any portion of this product or the load being supported.
- Do not allow children to play on or around this product or the load being supported.



Keep

clear of winch, rope, hook, and

fairlead while operating.



- The winch is not to be used to lift, support or otherwise transport personnel.



- ALWAYS be aware of possible hot surfaces at winch motor, drum or rope during or after winch use.
- ALWAYS ensure the operator and bystanders are aware of the stability of the vehicle and/or load.

Is your winch ready to pull?

- ALWAYS inspect winch rope, hook, and slings before operating winch. Frayed, kinked or damaged winch rope must be replaced immediately. Damaged components must be replaced before operation.
- Periodically check mounting hardware for proper torque and tighten if necessary.
- ALWAYS remove any element or obstacle that may interfere with safe operation of the winch.
- ALWAYS be certain the anchor you select will withstand the load and the strap or chain will not slip.
- Wire rope can break without warning. Always keep a safe distance from the winch and rope while under a load.
- ALWAYS keep wired pendant control lead and power cord clear of the drum, rope, and rigging. Inspect for cracks, pinches, frayed wires or loose connections. Damaged components must be replaced before operation.



- NEVER wrap winch rope back onto itself. Use a choker chain or strap.



- ALWAYS ensure hook latch is closed and not supporting load.



- NEVER apply load to hook tip or latch. Apply load only to the center of hook.
- NEVER use a hook whose throat opening has increased, or whose

tip is bent or twisted.

- ALWAYS use a hook with a latch.
- Never use winch rope for towing.
- NEVER use excessive effort to free spool winch rope.
- ALWAYS take time to use appropriate rigging techniques for a winch pull.

During the pull

- NEVER exceed winch or winch rope rated capacity. Double line using a snatch block to reduce winch load.
- Do not shock load the winch.
- Never use a winch to secure a load.
- ALWAYS unspool as much winch rope as possible when rigging. Double line or pick distant anchor point.
- Never engage or disengage the clutch when the winch is under load or the drum is moving.
- Pull from an angle of less than 5 degrees laterally and 15 degrees horizontally. Without maintaining the proper fleet angle of +/- 5 degrees; (See Figure 18 page 15) the rope will pile onto one side of the rope drum and possibly do damage to the rope or winch. Re-spool your winch as required.
- When winching a heavy load, lay a recovery damper or a heavy blanket over the middle third of the wire rope.
- ALWAYS avoid side pulls which can pile up winch rope at one end of the drum. This can damage winch rope or winch.
- ALWAYS ensure the clutch is fully engaged or disengaged. The type of duty is intermittent-periodic duty S3 and the load time never exceeds 2 minutes.
- NEVER submerge winch in water.

After Use

- Disconnect the hand held pendant from the winch when not in use.
- ALWAYS store the pendant control in a protected, clean, dry area.

Know Your Winch

Figure 1 - Winch Components

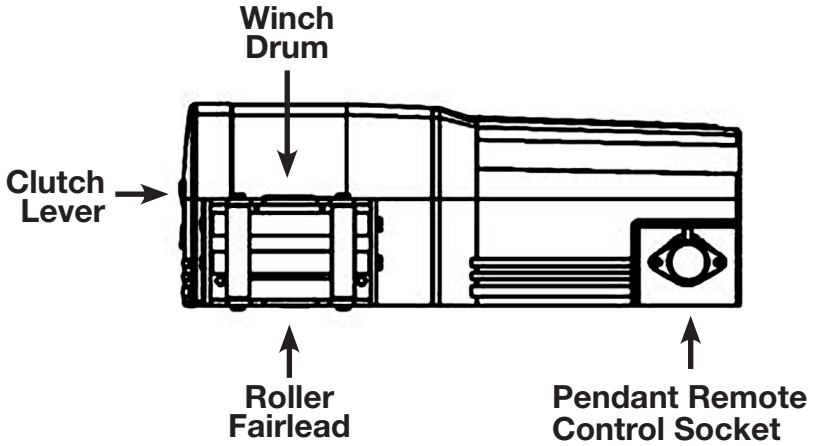

Pendant Remote Control



Circuit Breaker
(Varies Per Model)



Hand Saver
Cable Strap



Winch Mounting
Hardware

Features and Ratings

Load Rating

Load and speed varies according to how much wire rope is on the drum. The first layer of rope on the drum delivers the slowest speed and the maximum load. A full drum delivers the maximum speed and the minimum load. For this reason, all utility duty winches are rated at their first layer capacities.

Table 1 - Winch Capacity

DC2500			DC3500			DC4500		
Rope Layer	Capacity	Length of Rope on Drum	Rope Layer	Capacity	Length of Rope on Drum	Rope Layer	Capacity	Length of Rope on Drum
1st	2,500 lbs./ 1,134 kgs.	10.2 ft./ 3.1 m.	1st	3,500 lbs./ 1,588 kgs.	8.9 ft./ 2.7 m.	1st	4,500 lbs./ 2,041 kgs.	7.9 ft./ 2.4 m.
2nd	2,149 lbs./ 975 kgs.	22 ft./ 6.7 m.	2nd	2,954 lbs./ 1,340 kgs.	19.6 ft./ 6 m.	2nd	3,722 lbs./ 1,688 kgs.	17.4 ft./ 5.3 m.
3rd	1,885 lbs./ 855 kgs.	35.5 ft./ 10.8 m.	3rd	2,555 lbs./ 1,159 kgs.	31.8 ft./ 9.7 m.	3rd	3,174 lbs./ 1,440 kgs.	28.6 ft./ 8.7 m.
4th	1,678 lbs./ 761 kgs.	50 ft./ 15.2 m.	4th	2,251 lbs./ 1,021 kgs.	45.7 ft./ 13.9 m.	4th	2,766 lbs./ 1,255 kgs.	41.4 ft./ 12.6 m.
5th	N/A	N/A	5th	2,012 lbs./ 913 kgs.	50 ft./ 15.2 m.	5th	2,451 lbs./ 1,112 kgs.	50 ft./ 15.2 m.

Table 2 - Winch Specifications

Powered Winches	DC2500	DC3500	DC4500
Wire rope	3/16" x 50' A7 x 19 Aircraft Cable	7/32" x 50' A7 x 19 Aircraft Cable	1/4" x 50' A7 x 19 Aircraft Cable
Brake	Mechanical and dynamic brakes hold full load		
Clutch (free-spooling)	Free-spool lever		
Control	Handheld pendant switch		

Features and Ratings

Table 3 - Line Speed And Amp Draw

DC2500			DC3500			DC4500		
1st Layer Line Pull (lbs./kgs.)	Line Speed (FPM/MPM)	Amp Draw	1st Layer Line Pull (lbs./kgs.)	Line Speed (FPM/MPM)	Amp Draw	1st Layer Line Pull (lbs./kgs.)	Line Speed (FPM/MPM)	Amp Draw
No Load	16.4 / 5	30	No Load	21.3 / 6.5	25	No Load	21.3 / 6.5	25
1,000/454	11 / 3.5	80	1,000/454	16.4 / 5	110	1,000/454	16.4 / 5	110
2,000/907	7.5 / 2.3	150	2,000/907	11.8 / 3.6	200	2,000/907	11.8 / 3.6	210
2,500/1,134	4.2 / 1.3	200	2,500/1,134	10.5 / 3.2	230	2,500/1,134	10.5 / 3.2	240
N/A	N/A	N/A	3,000/1,361	8.2 / 2.5	260	3,000/1,361	8.2 / 2.5	270
N/A	N/A	N/A	3,500/1,588	5.9 / 1.8	300	3,500/1,588	5.9 / 1.8	290
N/A	N/A	N/A	N/A	N/A	N/A	4,000/1,814	4.6 / 1.4	310
N/A	N/A	N/A	N/A	N/A	N/A	4,500/2,041	1.3 / 0.4	330

FPM = Feet Per Minute MPM = Meters Per Minute

Installation Instructions

BEFORE INSTALLING AND USING YOUR POWERED WINCH, READ AND FOLLOW ALL MOUNTING INSTRUCTIONS AND SAFETY MESSAGES.

1. Mounting

⚠ WARNING

To prevent accidental activation of the winch and serious injury, complete the winch installation and attach the hook before installing the wiring.

1. Before Installation

1.1 Inspect Parts

Hand Saver Cable Strap

Clutch Lever

Instruction/Owners Manual

Winch Assembly

Drum Cover

Pendant Remote Control

Pendant Remote Control Socket

Roller Fairlead

6 Gauge Battery Lead

Hardware

Mounting Hardware Requirements

⚠ WARNING

ALWAYS torque mounting bolts to the values specified for your winch in Table 4 page 8 to prevent vibration during operation.

ALWAYS use Grade 5 / 8.8 Metric or better hardware.

NEVER weld mounting bolts.

ALWAYS choose the proper bolt length for your application.

ALWAYS confirm required bolt length to ensure proper thread engagement.

1.2 Select Mount Location

⚠ WARNING

ALWAYS choose a mounting location that is sufficiently strong to withstand the maximum pulling capacity of your winch.

1.2.1 Winch Mounting

⚠ WARNING

1. Your mounting surface must be equal to or greater than the footprint of the winch frame.
2. The wire rope shall be underwound as seen below.

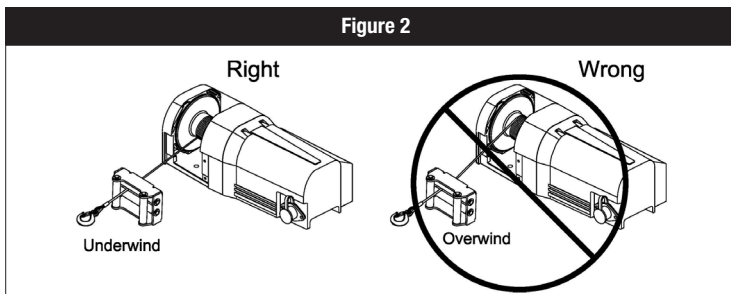

Installation Instructions

1.3 Determine Mount Position

WARNING

Failure to adequately align, support, or attach the winch to a suitable mounting base could result in a loss of efficiency of performance or damage to the winch, wire rope and mounting surface.

1.4 Install the Winch

1. Make sure the winch is aligned correctly
2. Set winch in mounting location. Confirm required bolt length.
3. Install bolts, nuts, and lock washers and tighten to torque specified in Table 4 below.

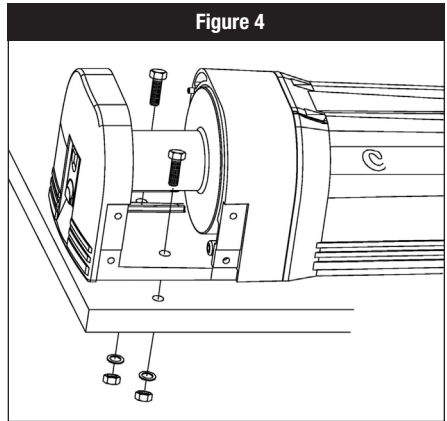
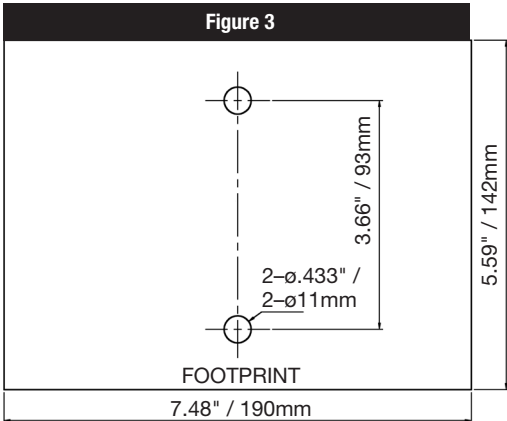

Table 4 - Mounting Torque Requirements

Powered Winches	DC2500	DC3500	DC4500
Winch Mounting Bolt Size	M10 x 1.5 pitch 8.8 grade 2 Required	M10 x 1.5 pitch 8.8 grade 2 Required	M10 x 1.5 pitch 8.8 grade 2 Required
Winch Mounting Bolt Torque	40 ft./lbs.	40 ft./lbs.	40 ft./lbs.

Installation Instructions

1.5 Install the Wiring

WARNING

BEFORE installing the winch, make sure all electrical parts are corrosion free. **ALWAYS** place the supplied terminal boots on wires and terminals as directed by the installation instructions.

NEVER lean over battery while making connections.

NEVER route electrical cables over battery terminals.

ALWAYS consult Electrical Connections section for proper wiring details.

Run the charging system during winching operations to keep battery charged.



NEVER route electrical cables across sharp edges.

NEVER route electrical cables near parts that get hot.



NEVER route electrical cables through or near moving parts.

AVOID pinch and wear/abrasion points when installing all electrical cables.

ALWAYS insulate and protect all exposed wiring and electrical terminals.

1.5.1 Battery Recommendations & Lead Size

A fully charged battery and good connections are essential for the proper operation of your winch. The minimum requirement for the battery is 650 cold cranking amps.

Table 5 - Wire Gauge Specifications

Model		DC2500	DC3500	DC4500
Control Type		Solenoid/Indirect		
Volt	12V	6 AWG × 5' (1.5 m)	6 AWG × 5'(1.5 m)	6 AWG × 5'(1.5 m)

1.5.2 Battery Cable Routing

Route battery connection cables in areas that will not cause them to wear or cut through the insulation causing a potential short circuit. The winch power wire must be routed to the battery. A direct battery connection of the power (red) and ground (black) cables is required.

WARNING

ALWAYS route battery cables along a path that allows the cables to be secured with zip ties. **Loose or unsecured power cables can cause serious injury or death.**

1. Plan the routing path.
2. Loosely secure power cables along path.
3. Confirm power cables are protected from sharp edges, heat and moving parts. Consider chassis flex and vibration which might damage cable.
4. Carefully inspect electrical cable routing. Zip tie and secure electrical cables. Zip ties should be snug, but not cutting into wire insulation. Use electrical tape, pieces of rubber hose or electrical conduit to protect electrical cables and wire harness where needed to avoid electrical cable insulation wear or abrasion.
5. **FIRST** attach red (positive) battery cable, then black (negative) battery cable. Install boots as appropriate to protect connections. Torque battery terminal fasteners to 124 in/lbs (14 N-m). See Figure 5, page 10.

Installation Instructions

Figure 5 - Torque Specification

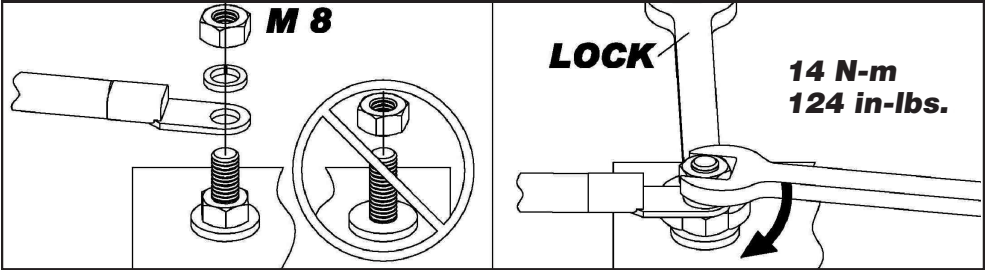

1.5.3 System Check

Upon completion of installation, check winch for proper operation. The voltage drop for the winch motor must not exceed 10% of the nominal voltage of 12/24 DC.

Figure 6 - DC2500, DC3500 & DC4500 Wiring Diagram

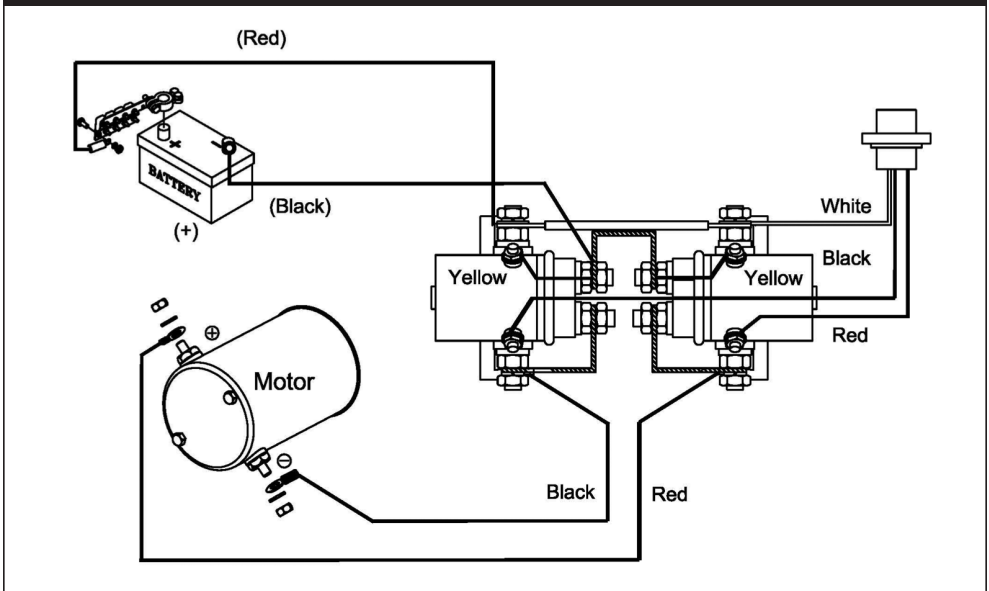

Installation Instructions

1.6 Know Your Wireless Remote

WARNING

Never lose sight of the winch or jack while using the wireless remote.

Never touch the winch or jack while the remote is in someone else's hands.

Figure 7 - Wireless Remote Components

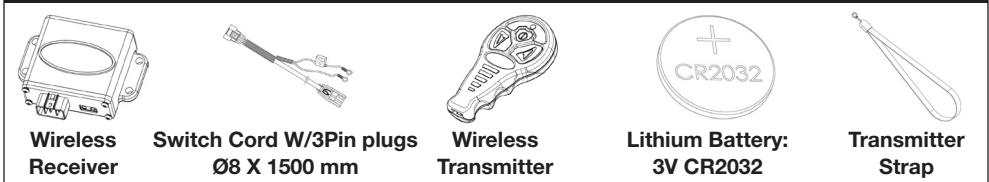

1.6.1 Wireless Remote and Transmitter Specifications

1. Transmission range: 15 ~ 27 m (50 ~ 90 ft)
2. Receiver operation voltage: 8 ~ 24 V
3. Receiver fuse current rating: 7.5 A
4. Protection: IP-66
5. Operating temperature range: -20°C ~ +70°C
6. LED indication: Green light for power on; Red light for operating; Blinking green for low battery life; Blinking red light for poor signal received

Figure 8 - Wireless Remote

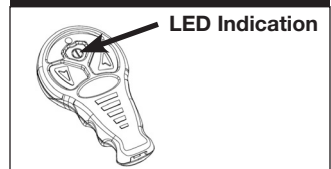

1.6.2 Wireless Remote and Transmitter Installation

1. Connect The Wiring

Connect the Switch cord W/3 or 6 Pin plugs to the socket on the control pack.
Connect the Red wire to the positive (+) terminal of the battery.
Connect the Black wire to the negative (-) terminal of the battery.

Figure 9 - Connections

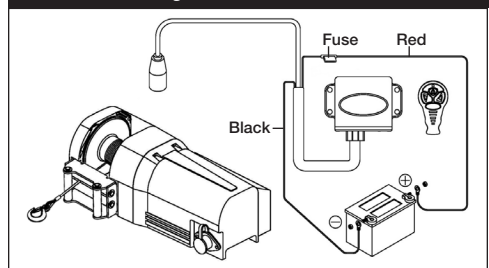

2. Mount the Receiver

The receiver should be mounted in a clear and dry location.
Mount on a flat surface with at least 2 fasteners (not included) through the 7 mm mounting holes on each side of the receiver. Minimum of one mounting fastener each side

Figure 10 - Mounting

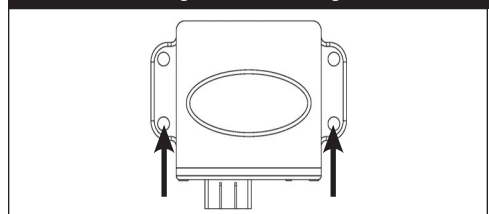

Installation Instructions

1.6.3 Wireless Remote and Transmitter Installation

1. Install Battery

- Remove the three screws from the wireless transmitter.
- Separate the top section, insert the battery positive (+) side up and replace the top section.
- Replace the three screws.

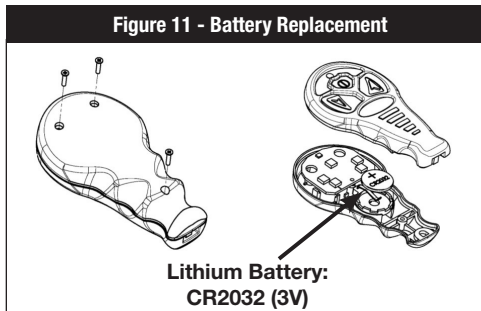

2. Test

- Press the Power Button for 5 seconds until the Green light comes on.
- Press the In/Down or Out/Up button. The Red indicator light will come on.

Figure 12 - Operations

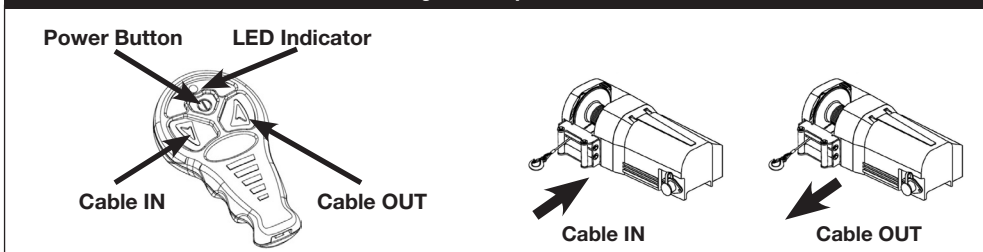

3. Stop

- The system will automatically shut down the transmitter if not activated for 5 minutes.
- Press and hold the Power Button for 5 seconds to shut down the transmitter.

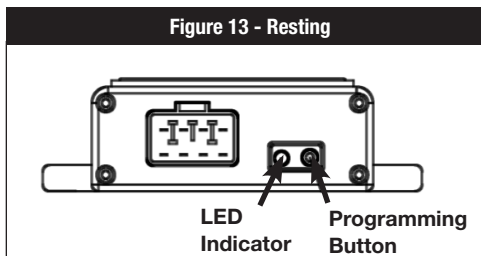

4. Reset

- Press and hold the Programming Button for 5 seconds until the Red indicator illuminates.
- Press the Power Button on the transmitter for 5 seconds until the Green indicator lights up.
- Press the In or Out button on the transmitter until the Red indicator light on the receiver turns off.
- Reset is now completed. Please note only one remote transmitter can be reset for each receiver.

5. Notes

- The wireless remote control and wired remote can be exchanged for activating the winch or jack.
- Blinking Green LED light shows the transmitter battery is low, the battery should be replaced immediately.
- Please note only one remote can be reset for each receiver.
- Blinking Red LED for poor signal.

Operation Instructions

WARNING

ALWAYS use supplied hand saver cable strap whenever spooling winch rope in or out, during installation or operation to avoid injury to hands and fingers.

2.1 Spooling in Under Load

WARNING

NEVER exceed winch's rated line pull. Power-in the winch rope evenly and tightly on the drum. This prevents the outer winch wraps from sinking into the inner wraps, binding and damaging the winch rope.

NEVER touch winch rope or hook while someone else is at the control switch or during winching operation.

Do not shock load the winch when spooling. Avoid shock loads when spooling by pulsing the control switch to take up winch rope slack. Shock loads can momentarily far exceed the winch and rope ratings.

NOTICE

DO NOT power the hook into the fairlead. This could cause damage to the fairlead.

2.2 Overloading / Overheating

The type of duty is intermittent-periodic duty S3 and the load time never exceeds 2 minutes. When the motor approaches stall speed, very rapid heat buildup occurs which may cause motor damage. Double-line rigging will reduce the amperage draw, and reduce heat buildup in the motor. This allows longer continual use.

2.3 Stretching the Wire Rope

WARNING

ALWAYS pre-stretch rope and re-spool under load before use. Tightly wound rope reduces chances of "binding", which can damage the rope.

NEVER operate winch with less than five (5) wraps of wire rope around the drum. Rope could come loose from the drum, as the rope attachment to the drum is not designed to hold a load.

The goal of stretching your wire rope is to wrap it tightly on the winch drum so that it can support additional layers of wire. This can be accomplished with a vehicle supplied as dead weight to stretch the rope. This is an exercise that will make your wire rope last longer, avoid tangles and ensure a tightly wrapped winch. Use care to evenly wrap each layer to prevent damage to the rope.

2.4 Safe Working Conditions

WARNING

The operator should **ALWAYS** operate the winch from a safe position when pulling a load. The safe areas are: Perpendicular to the winch rope.

The safe position will help prevent the wire rope from striking the operator if the wire rope fails when under load.

Fully extend the pendant control cord to operate winch whenever possible. The operator must try to maintain at least 8 ft. (2.44 m) from the winch while operating.

WARNING

NEVER work around the winch rope while under load.

NEVER step over a winch rope while under load.

ALWAYS use caution when working with electricity and remember to verify that no exposed electrical connections exist before energizing your winch circuit.

Operation Instructions

2.5 For First Time operation

2.5.1 Handheld Pendant Control

Industrial grade and waterproof remote. DC2500, DC3500 and DC4500 winches includes LED overheating indicator.

2.5.2 Connect the remote control

Always keep the remote control wire clear of the winch, wire rope and roller fairlead. Figure 14.

WARNING

DO NOT leave the pendant control plugged into the winch when not in use. This may result in a dangerous condition and/or battery drain.

1. Press and hold the Cable In Button for rope winding in operation.
2. Press and hold the Cable Out Button for rope winding out operation.
3. To stop winching, release the Cable In or Cable Out Buttons. Figure 15.

Figure 14 - Connect Remote

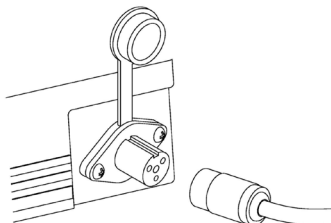
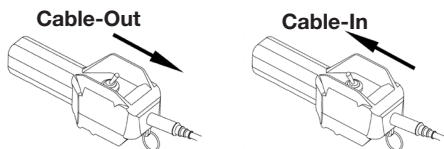

Figure 15 - Cable Button



2.6 Clutch Operation

WARNING

NEVER engage or disengage clutch if winch is under load, winch rope is in tension or drum is moving.

To prevent damage, **ALWAYS** fully engage or fully disengage the clutch lever.

The clutch lever allows rapid wire rope payout for hooking onto the load or anchor points and is operated by a clutch lever.

The clutch lever must be in the

“Engaged” position before winching (fig 16)

1. To disengage the clutch lift the clutch lever to the “Disengaged” position, wire rope can now be free spooled on the drum (fig 17)
2. To engage the clutch, lower the clutch lever to the “Engaged” position
3. If the clutch lever can't be properly locked in the “Disengaged” position, rotate the drum to into a position by hand to Engage or Disengage completely.
4. Wear leather gloves and use a handsaver strap when guiding the wire rope out of the drum.

Figure 16 - Engaged Clutch

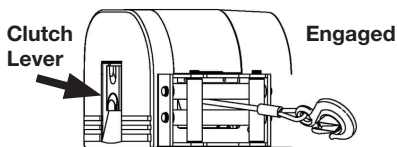
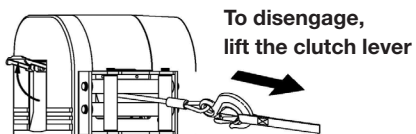

Figure 17 - Disengage Clutch



Operation Instructions

2.7 Winching Principles

2.7.1 Calculating Fleet Angle

CAUTION

To obtain the best wire rope service, the direction of pull will be on a horizontal within ± 15 degrees and perpendicular to the centerline of the winch drum within ± 5 degrees. Short pulls of up to 45 degrees laterally are acceptable; however without maintaining the proper fleet angle; the rope will pile onto one side of the rope drum and possibly do damage to the rope or winch. Re-spool your winch as required. Figure 18

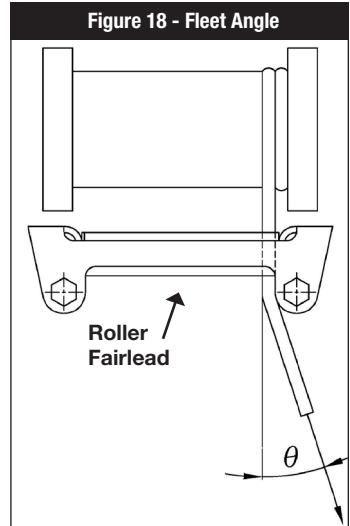

2.7.2 Recovery Damper

WARNING

A recovery damper is a safety device designed to help reduce the possibility of injury or property damage in the event of a wire rope failure. Place in the middle third of a live rope. Figure 19.

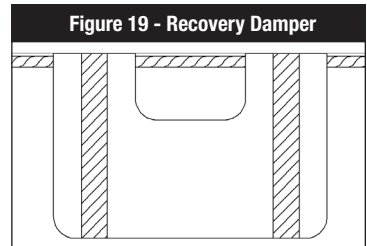

2.7.3 Snatch Block

An important aid to successful winching is the use of snatch block, which can be used to increase the pulling power of a winch or change the direction of a pull.

A winch double lined with a snatch block creates a mechanical leverage cutting the effort required by nearly half.

The use of one snatch block shows an indirect pull where the vehicle is limited due to unsuitable ground or obstruction. The pull on the load is the actual line pull of the winch. If more than one snatch block is used, they must be located at least 40" (100 cm) apart. Figure 20.

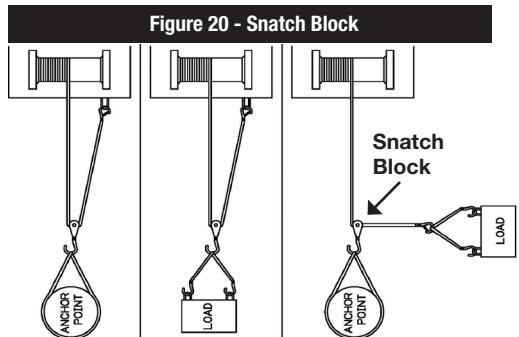

Operation Instructions

WARNING

Do not use the winch as a lifting device or a hoist for vertical lifting.

CAUTION

The Power-Out function should be used for relieving tension on the rope, not for extended distances.

The Power-Out function drives the winch motor against the brake which is similar to driving your vehicle with the parking brake engaged. Do not use the Power-Out function for lowering a load -- winches are not designed to be used as hoists. Use the free-spool function to pay out wire rope. If you Power-Out over 25 feet, let the winch cool for 15 minutes.

Maintenance

3.1 Install/Replace the Rope

WARNING

ALWAYS complete the winch installation and hook attachment before installing the wiring. **ALWAYS** pre-stretch rope and re-spool under load before use. Tightly wound rope reduces chances of “binding”, which can damage the rope.

A minimum of five (5) wraps of steel wire rope around the drum is necessary to support the rated load.

ALWAYS spool the winch rope onto the drum in the direction specified by the drum rotation labels on the winch and/or in the documentation. This is required for the automatic brake to function properly.

Never substitute a heavier or lighter rope. Never use rope made of any material other than wire.

1. Un-spool the entire wire rope, then take it out from the drum.
2. Put the replacement wire rope through the fairlead opening, pass below the drum, and insert it into the hole of drum core.
3. Tighten the screw downwards to secure the wire rope.

Figure 21

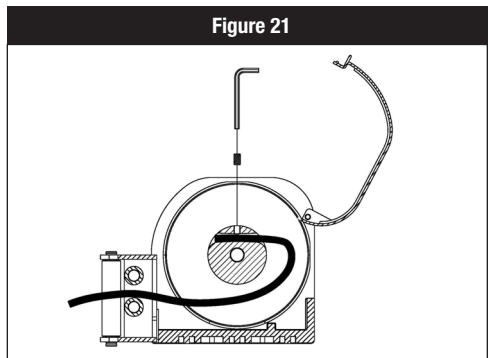

Maintenance

- **Check the wire rope.** Before winching, make sure the rope is wound on the drum evenly. If there is mixed winding, it is essential to rewind it evenly.
- Be careful to keep the rope under tension. Never guide a wire rope onto the drum with your hand, use a hand saver cable strap.

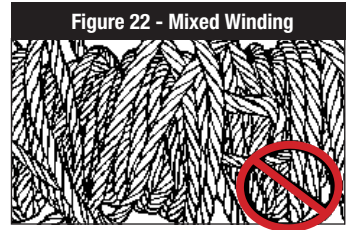

3.2 Lubrication

All moving parts in the winch are permanently lubricated at the time of assembly. Under normal conditions factory lubrication will suffice. If re-lubrication of gear box is necessary after repair or disassembly use Shell EP2 or equivalent grease. Regularly lubricate Clutch Lever with light oil. Never lubricate the brake system.

Troubleshooting

Table 6 - Troubleshooting

Symptom	Possible Cause	Remedy
Winch will not operate	Cut circuit	Check battery lead
	Weak battery	Recharge or replace battery, 650CCA
	Damaged circuit breaker	Replace circuit breaker
	Bad connection of wiring	Reconnect tightly
	Damaged DC solenoid	Replace DC solenoid
	Cut circuit on switch	Replace switch
	Damaged motor or carbon brush	Replace motor or carbon brush
	Poor or lost connections to motor	Replace wiring or tighten it
Motor runs in one direction.	Broken wiring or bad connections	Reconnect or replace wiring
	Damaged or stuck DC solenoid	Replace DC solenoid
	Switch inoperative	Replace switch
Drum will not clutch.	Clutch does not disengage	Replace clutch
	Damaged 1st shaft	Replace 1st shaft
	Damaged brake cam and disc	Replace brake cam and disc
	Damaged output shaft	Replace output shaft
No brake	The gear train is mechanically binding up	Check to insure the winch is mounted on a flat, rigid surface
	Damaged brake cam and disc	Replace brake cam and disc
	Damaged gear box	Replace gear box
	Broken retaining ring	Replace retaining ring
	Oil leakage into brake cavity	Repair and clean oil leakage
	Damaged or inoperative spiral spring	Replace and position spiral spring
Brake distance is too long	Worn brake disc or loose brake spacer	Replace brake disc
	Oil leakage into brake cavity	Repair and clean oil leakage
Brake will be locked	Too much brake disc powder in the brake hub	Clean brake hub
	Over tensioned spiral spring	Adjust tension on spiral spring
	Stuck between brake disc and gear box	Replace with new brake assembly
Damaged gear box	Hit by certain exterior force	Replace the damaged components
	Damaged gear train	Replace the damaged components
	Over load operation	Stop the winch operation and reduce the load
Motor runs extremely hot	Long period of operation	Allow to cool
	Damaged motor	Replace or repair motor
	Damaged or inoperative brake	Replace or repair brake

Checklist

Table 7 - Checklist

Classification of Check			Item		Checking method	Checking reference
Daily	Periodical					
	Monthly	Yearly				
x			Installation	Mounting bolts & alignment	Bolt tension & wear	Existence of abnormalities
x			Remote control	Working	Manual	Reasonable actuation
		x		Wearing in contact points	Visual	Free of wear or damage
x			Wire rope	Broken strands	Visual, measuring	Less than 10%
x	x			Rope	Visual, measuring	7% of nominal diameter max
x				Fastening condition of end	Visual	Existence of abnormalities
x				Deforming or corrosion	Visual	Existence of abnormalities
		x	Clutch assembly	Damaged clutch assembly	Visual evidence of wear	Free of wear or damage
		x	Motor	Staining, damage	Visual evidence of wear	Existence of abnormalities
		x	Brake	Wearing of brake disc	Visual evidence of wear	Free of wear or damage
x				Performance	Visual	Reasonable actuation
		x	Gear	Damage, wear	Visual evidence of wear	Free of wear or damage

Checklist

Table 8 - Checklist

	Before First Operation	After EVERY Use	Every 90 Days
Read, understand and follow the warnings and instructions in this manual.	X		
Check all fasteners and verify they are at the proper torque. Replace fasteners as needed.	X		X
Check that the wiring is correct and the connections are tight	X		X
Check that there are no bare or exposed wires, terminals, or damage to the cables. Cover terminals with boots. Repair or replace wires as needed.	X		X
If damaged, discontinue use and replace rope immediately.	X	X	X
Keep winch, rope, and switch control free from contaminants. Use a clean rag or towel to remove any dirt and debris.		X	