



# Bulldog Collar-Lok™ Couplers

## Read, Understand, Follow and Save These Instructions

Read, understand and follow all of these instructions and warnings (Instructions) before installing and using this product. Install and use this product only as specified in these instructions. Improper installation or use of this product may result in property damage, serious injury, and/or death. Never allow installation or use of this product by anyone without providing them with these instructions. You must read, understand and follow all instructions and warnings for any product(s) to which this product is used in conjunction with or installed. Save these instructions with the product for use as a reference for any future installation and use of the product.

### ⚠ WARNING

**Failure to follow these warnings and instructions may result in property damage, serious bodily injury, and/or death.**

- Purchaser/owner must ensure that product is installed according to these instructions.
- Purchaser/owner must not alter or modify product.
- Operator and bystanders should never position any part of body under any portion of this product or the load being supported.
- Do not allow children to play on or around this product or the load being supported.
- Never exceed maximum rated capacity. Refer to stamped markings or decals on product to obtain rated capacity.
- Use only the proper ball for this coupler as indicated on the coupler body.
- Always secure load, vehicle and trailer (by blocking wheels) before latching/unlatching coupler.
- Use caution when uncoupling as tongue may rise suddenly due to negative tongue load.
- After installing channel and/or coupler, if coupler operation has been impaired in any way, do not use it.
- Keep the ball pocket and mechanism clean. When parking or storing your trailer, keep the coupler off the ground so dirt and/or other foreign material will not build up in the coupler ball pocket.
- Do not tow if ball is not fully seated and/or coupler is not closed.
- All welding must be performed by a AWS certified welder.
- This product rated according to SAE J684.

#### Before Towing:

- Check vehicle, channel, hitch, hitch ball and coupler for signs of wear or damage and that the coupler handle opens and closes freely. If coupler and/or channel is deformed or damaged, replace complete coupler and bracket.
- Always replace bent, broken, or worn parts before using this product.
- Close coupler securely by ensuring that the hitch ball is fully seated in the coupler ball pocket and the pin is inserted behind the collar or latch.
- Check channel hardware for wear and proper tightness. Replace bent, broken, or worn hardware. Tighten hardware to appropriate SAE proofload specifications (See table specs). Use only grade 5 hardware.
- Make sure that the trailer safety chains are properly connected to the towing vehicle and trailer according to SAE J684.
- Make sure that all trailer lighting is hooked up and working properly.

## Installation Instructions

**Warning: Failure to follow these warnings and instructions may result in property damage, serious bodily injury, and/or death.**

Before mounting the coupler confirm that there will be no interference from the tow vehicle, tongue, ground, and any other mounted accessories while stationary or in motion. Before installing, check for interference in open and closed positions. Check for interference again after installation is complete. All welding must be performed by an AWS certified welder. The coupler must be rigidly attached to the trailer in order for the coupler to support its maximum rated load according to SAE J684. After installation, check to make sure that coupler operation has not been impaired in any way. Do not use coupler if its operation has been impaired.

#### Weld-on Instructions

- All welding must be performed by an AWS certified welder.
- If using a weld-on coupler, weld 3/16" around the interface between coupler and tongue. See illustrations below.
- Assure the coupler internal stop is butted against the end of the trailer tongue for maximum overlap.

#### Bolt-on Instructions

- Assure that the coupler internal stop is butted against the end of trailer tongue for maximum overlap before securing.
- Torque grade 5 bolts with locknuts to appropriate SAE proof load specifications (See table specs). No deformation of trailer tongue end allowed.
- The number and size of fasteners required must be specified by the trailer manufacturer.

Torque Specs	
□ 3/8"	- 23 ft. lbs.
□ 1/2"	- 55 ft. lbs.
□ 5/8"	- 110 ft. lbs.

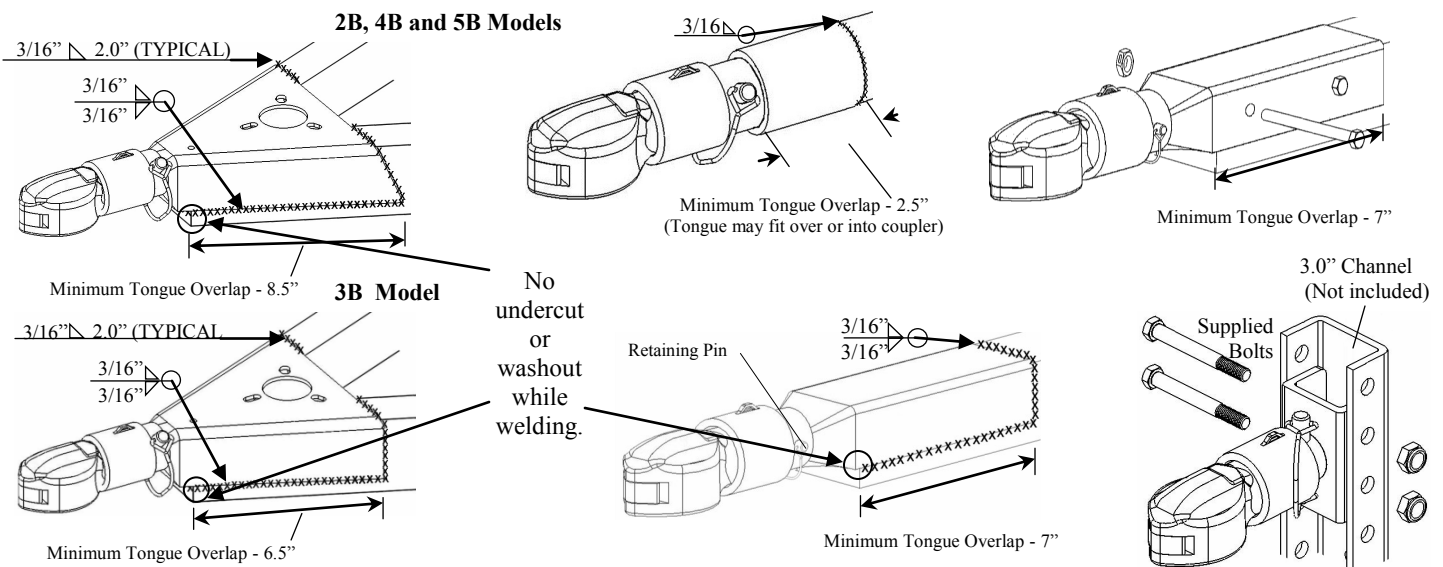

## Maintenance

Keep ball pocket and mechanism clean. The following procedures should be performed at least annually:

- Check set screw torque.
- Grease ball pocket.
- Oil pivot points with SAE 30 wt. motor oil.
- Inspect retaining pins and replace if necessary.

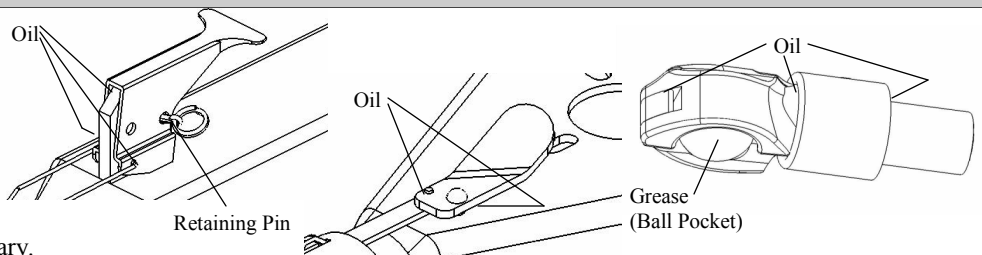

# Operation

## M-Style Coupler

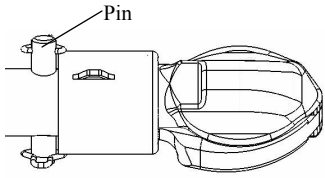

### To Couple:

- 1) Block trailer wheels.
- 2) Align hitch ball beneath coupler.
- 3) If the coupler is closed, open it by removing the pin behind the collar and sliding the collar away from the ball pocket. Be sure the coupler cap is open and holds the collar back.
- 4) Lower the trailer onto the hitch ball.
- 5) Visually check that the hitch ball is fully seated in the coupler.
- 6) After the hitch ball is seated in the coupler, carefully close the coupler cap. Be sure the collar springs toward the ball pocket and captures the coupler cap.
- 7) Reinsert the pin behind the collar. Do not tow without pin in place.

## L-Style Coupler

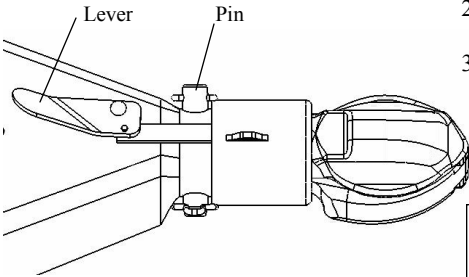

### To Uncouple:

- 1) Block trailer wheels.
- 2) Open the coupler by removing the pin behind the collar and sliding the collar away from the ball pocket. Be sure the coupler cap is open and holds the collar back.
- 3) Raise the trailer from the hitch ball.

### Coupler is Open Cap is Open

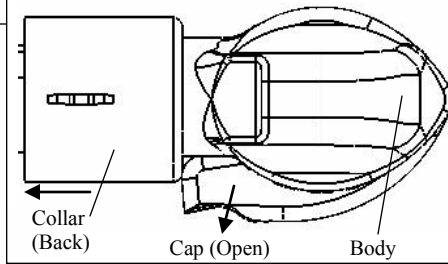

### Coupler is Closed Collar is Capturing Cap

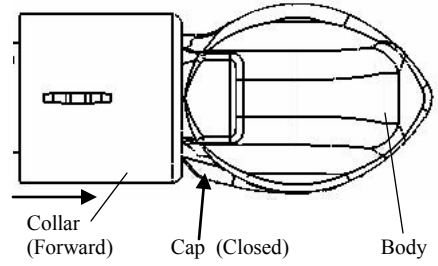

## H-Style Coupler

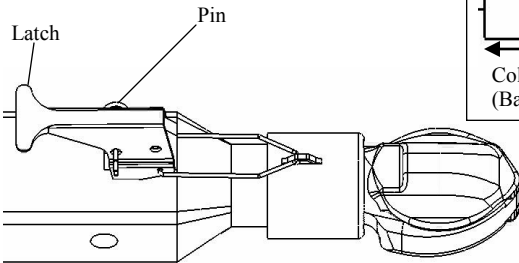

### To Couple:

- 1) Block trailer wheels.
- 2) Align hitch ball beneath coupler.
- 3) If the coupler is closed, open it by removing the pin in the latch and lifting the latch. Be sure the coupler cap is open and holds the collar back.
- 4) Lower the trailer onto the hitch ball.
- 5) Visually check that the hitch ball is fully seated in the coupler.
- 6) After the hitch ball is seated in the coupler, carefully close the coupler cap and lower the latch. Be sure the collar springs toward the ball pocket and captures the coupler cap.
- 7) Reinsert the pin in the latch. Do not tow without pin in place.

### To Uncouple:

- 1) Block trailer wheels.
- 2) Open the coupler by removing the pin in the latch and lifting the latch. Be sure the coupler cap is open and holds the collar back.
- 3) Raise the trailer from the hitch ball.