

# BRISK®

USA ENTERPRISES, LLC



➤ *More Power*

➤ *Faster Acceleration*

➤ *Durability*

## BRISK SILVER *Racing*



MAGNETIC  
TERMINAL NUT  
FOR EASY REMOVAL

HIGH DIELECTRIC  
STRENGTH  
INSULATOR

ONE PIECE SHELL  
CONSTRUCTION  
*does not separate upon  
removal like other brands*

SILVER CENTER  
ELECTRODE  
*the Best Electrical and  
Thermal Conductor*

GAPABLE CUTBACK  
GROUND STRAP  
CONFIGURATION  
*easy to gap, excellent spark exposure,  
great flame-front propagation*

### **Black Ignition Boot**

2004-2008 3 Valve Ford Engine

- **3VR10S**
- **3VR12S**
- **3VR14S**
- **3VR17YS**

### **Brown Ignition Boot**

NEW for the 2008-2010 3 Valve Ford Engine

- **XOR12YS**
- **XOR14YS**



*Justin Burcham*



*Vinny Barber*

# CYLINDER HEAD

CYLINDER HEAD MANUFACTURER

SPEC SHEET RECOMMENDATION

BRISK EQUIVALENT RACING PLUGS

## AIR FLOW RESEARCH

205cc LS1 Mongoose Street Head	AC 41-974 Platinum	GR15YS, GOR15LGS, GR15ZC, GOR15YTE
225cc LS1 Mongoose Strip Head	AC 41-974 Platinum	GR15YS, GOR15LGS, GR15ZC, GOR15YTE
180cc SBC Street Head	AC FR3LS	DR15YS, DOR15LGS, DR15ZC, DOR15YTE
180cc LT1 Street Head	AC FR3LS	DR15YS, DOR15LGS, DR15ZC, DOR15YTE
195cc SBC Street Head	AC FR3LS	DR15YS, DOR15LGS, DR15ZC, DOR15YTE
195cc LT4 Street Head	AC FR3LS	DR15YS, DOR15LGS, DR15ZC, DOR15YTE
305/315/325/335/345/357cc Magnum BBC	CHA C59C, AUT 3932	D10S, DO10LGS-T (index free plug)
165/185cc SBF Outlaw Street Heads	AUT 3924	DR15YS, DOR15LGS, DR15ZC, DOR15YTE
205/224cc SBF Outlaw Race Heads	AUT 3922	DR14YS, or DR14S (non-projected tip)
165/185cc SBF Street/Strip Outlaw Heads	AUT 3924	DR15YS, DOR15LGS, DR15ZC, DOR15YTE

## BRODIX

BBC, Big Brodie Series	NGK B9ES	gas L11SL, L10SL Alcohol
C.A.R.B. Legal Heads	CHA 14YC or AUT 3924	DR15YS, DOR15LGS, DR15ZC, DOR15YTE

## DART

Big Chief, All	.750" reach, gasket, CHA C57C/C57YC	D08S, DO10LGS-T (index free plug)
Big M- Head	.750" reach, gasket, CHA C59C/C59YC Street RC12YC	D10S, Street app. DR15YS
Ford 20 Degree	.750" reach, gasket, CHA C59C/C59YC	D10S, DO10LGS-T (index free plug)
Iron Eagle, 308cc & 345cc BBC	.750" reach, gasket, CHA C59C/C59YC Street RC12YC	D10S, Street app. DR15YS
Iron Eagle, 23 Degree, 180, 200, 215, 230cc SBC	Angle or Straight, 460" Reach, Tapered Seat, CHA V59C/V59YC	H08S, HO11LGS-T (index free plug)
Iron Eagle S/S	Straight, 460" Reach, Tapered Seat, CHA RV12YC/AQC R44TS	HR17YTE (stubby), HOR15LGS, HR14YS
Little Chief, 11 Degree SBC Head	CHA C57C/C57YC	D08S, DO10LGS-T (index free plug)
Pro 1, 23 Degree SBC & BBC all cc's	CHA C59C/C59YC	D10S, DO10LGS-T (index free plug)
Race Series, 220cc SBC Head	CHA C59C/C59YC	D10S, DO10LGS-T (index free plug)
Race Series, 18 Degree BBC Head	CHA C57C/C57YC	D08S, DO10LGS-T (index free plug)

## EDELBROCK

All Except Flathead		DR15YS, DOR15LGS, DR15ZC, DOR15YTE
---------------------	--	------------------------------------

## FORD RACING PERFORMANCE PARTS

GT-40 "Turbo-Swirl" Alum. Cyl Heads		DR14YS, DOR14LGS, DR14ZC
GT-40X "Turbo-Swirl" Alum Cyl Heads		DR14YS, DOR14LGS, DR14ZC
"Sportsman" Short Track Cast Iron Cyl Heads		HR14YS, HOR14LGS, HO14LGS
"Z" Aluminum Heads		DOR15LGS
Robert Yates Alum. Cyl Heads		L- style sparkplug (13/16hex, 14mm, gasket)
"High Port" Yates Head		L- style sparkplug (13/16hex, 14mm, gasket)
High Port Head for all out Performance		L- style sparkplug (13/16hex, 14mm, gasket)
Super Cobra Jet Cylinder Heads		DR14YS, DOR14LGS, DR14ZC

## PRO TOPLINE

Iron Lightning, Pro Lightning	CHA V55C, V57C	H08S, HO11LGS-T (index free plug)
Other	CHA C55C, C57C	D08S, DO10LGS-T (index free plug)

## TRICK FLOW

Track Heat Alum. Cyl. Heads for SB Ford	AC FR3LS, AUT 3924, NGK 7373	DR15YS, DOR15LGS, DR15ZC, DOR15YTE
18 Degree Alum. Heads for SB Chevy	CHA C57C, NGK R5671A-10	D08S, DO10LGS-T (index free plug)
23 Degree Alum. Heads for SB Chevy	AC FR3LS, AUT 3924, NGK FR5, CHA RC	DR15YS, DOR15LGS, DR15ZC, DOR15YTE
R-Series Cyl. Head for BB Chevy	AUT 3922	DR14YS, DOR14LGS, DR14ZC

## WORLD

Windsor Jr		HR14YS, HOR14LGS, HO14LGS
Windsor Jr. Lite		DR15YS, DR14YS, DOR14LGS, DR14ZC
Windsor Sr. Lite		DR15YS, DR14YS, DOR14LGS, DR14ZC
Rough 200 Cast Iron		HR14YS, HOR14LGS, HO14LGS
Torquer 440 Aluminum		D10S, DO10LGS-T (index free plug), D08S
Sportsman II Lite		DR15YS, DR14YS, DOR14LGS, DR14ZC
S/R		HR17YTE (stubby), HOR15LGS, HR14YS
S/R Torquer		HR17YTE (stubby), HOR15LGS, HR14YS
Sportsman II		HR17YTE (stubby), HOR15LGS, HR14YS
Motown 205/220		HR17YTE (stubby), HOR15LGS, HR14YS
Motown 220 Lite		DR15YS, DR14YS, DOR14LGS, DR14ZC
Merlin II Oval & Rect. Port		HR17YTE (stubby), HOR15LGS, HR14YS
320cc & 345cc Merlin		DR15YS, DR14YS, DOR14LGS, DR14ZC

**WARNING:** Cross reference is provided for convenience only!  
Prior installation please confirm spark plug recommendation with cylinder Head manufacturer and/or engine builder/tuner



# BRISK SPARK PLUGS IDENTIFICATION SYSTEM

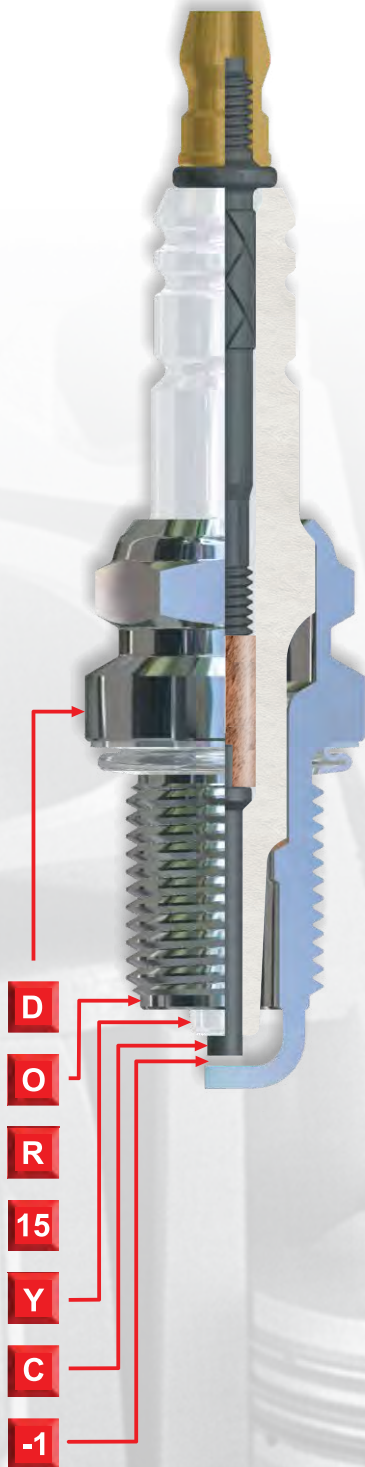

**D**

## METALL SHELL DIMENSIONS

**A B D E F G H L N R T**

TYPE				Conical seat	Gasket seat
A	M10x1	19mm	16mm		•
B	M12x1.25	19mm	17,5mm		•
D	M14x1.25	19mm	16mm		•
E	M14x1.25	26,5mm	16mm		•
F	M18x1.5	11,2mm	21mm	•	
G	M14x1.25	17,5mm	16mm	•	
H	M14x1.25	11,2mm	16mm	•	
J	M14x1.25	9,5mm	21mm		•
K	M14x1.25	9,5mm	21mm		•
L	M14x1.25	19mm	21mm		•
N	M14x1.25	12,7mm	21mm		•
P	M14x1.25	9,5mm	19mm		•
R	M14x1.25	25mm	16mm	•	
U	M14x1.25	7,8mm	16mm	•	
NA	M10x1	12,7mm	16mm		•
T	M10x1	12,7mm	16mm		•
M	M12x1.25	26,5mm	16mm		•

**O**

## METALL SHELL PROJECTED INTO COMBUSTION CHAMBER

- O** Complies with relevant ISO standard
- O** Does not comply with relevant ISO standard

**R**

## INTERFERENCE SUPPRESSION

- R** No Interference suppression
- R** Interference suppression
- X** Resistor reducing electrode burn-off

**15**

## HEAT RANGE

**19 18 17 16 15 14 12 11 10 09 08**  
Hot ← → Cold

**Y**

## SPARK GAP DESIGN

- Y** Not projected Insulator nose
- Y** Projected Insulator nose
- L** Extremely projected Insulator nose
- D** Extended Insulator nose and two ground electrodes
- T** Extended insulator nose and three ground electrodes
- G** Not projected insulator nose and ring-shaped electrode
- LG** Extremely projected Insulator nose and ring-shaped spark gap
- Z** Two auxiliary electrodes on the insulator nose and ring-shaped electrode gap
- TX** One auxiliary electrode on the insulator nose and three ground electrodes
- LT** Extremely projected insulator nose and three ground electrodes

**C**

## ELECTRODE MATERIAL

- C** Nickel-alloy centre electrode
- C** Copper cored centre electrode or electrode made of special alloyed Itrium with cooper
- E** Copper cored centre and ground electrode alloyed with yttrium
- S** Silver centre electrode
- P** Centre electrode with platinum contact
- PP** Centre and ground electrode with platinum contact
- PY** Centre electrode with platinum pad and yttrium alloyed ground electrode
- IR** Iridium pad on the centre electrode

**-1**

## SPARK GAP

- 1** 0.4-0.9 mm
- 1** 1.0-1.1 mm
- 3** 1.3 mm
- 9** 0.9 mm - Special design
- T** Special design

*Silver*

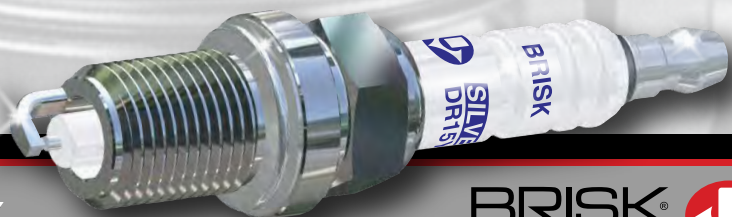

**BRISK**  
USA ENTERPRISES, LLC





**A**

TYP obj. č.

MANUFACTURER HEAT RANGES						
BRISK	8	10	12	14	15	17
NGK	10	9	8	7	6	5
DENSO	31	27	24	22	20	16

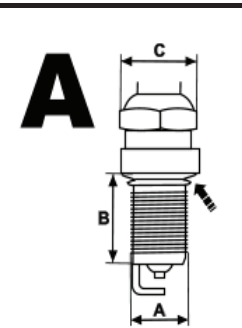

A - M10x1.00  
B - 19mm (3/4")  
C - 16mm (5/8")

10-15 Nm  
7-11 lb.ft.

TYP	obj. č.	GAP (mm)	THREAD	REACH	HEXAGON	SEAT	DESIGN	RESISTOR	PROJECTED			
silver	..S	A10S	1495	0.7	10mm	19mm-3/4"	16mm-5/8"	gasket	Silver Center Electrode	no	no	
		A08S		0.7	10mm	19mm-3/4"	16mm-5/8"	gasket	Silver Center Electrode	no	no	
		AR10S	1517	0.7	10mm	19mm-3/4"	16mm-5/8"	gasket	Silver Center Electrode	yes	no	
		AR08S	1516	0.7	10mm	19mm-3/4"	16mm-5/8"	gasket	Silver Center Electrode	yes	no	
	..YS	A14YS		0.7	10mm	19mm-3/4"	16mm-5/8"	gasket	Silver Center Electrode	no	yes	
		A12YS		0.7	10mm	19mm-3/4"	16mm-5/8"	gasket	Silver Center Electrode	no	yes	
		AR14YS	1519	0.7	10mm	19mm-3/4"	16mm-5/8"	gasket	Silver Center Electrode	yes	yes	
		AR12YS	1518	0.7	10mm	19mm-3/4"	16mm-5/8"	gasket	Silver Center Electrode	yes	yes	
	premium	..GS	AR08GS	1515		10mm	19mm-3/4"	16mm-5/8"	gasket	Silver-Surface Discharge	yes	no
		..LGS	AOR14LGS	3090		10mm	19mm-3/4"	16mm-5/8"	gasket	Lamborghini Design	yes	semi
			AOR12LGS	1514		10mm	19mm-3/4"	16mm-5/8"	gasket	Lamborghini Design	yes	semi
			AOR10LGS	1513		10mm	19mm-3/4"	16mm-5/8"	gasket	Lamborghini Design	yes	no
..ZS	AR12ZS	1208		10mm	19mm-3/4"	16mm-5/8"	gasket	Multi-Spark	yes	yes		
	AR10ZS	1181		10mm	19mm-3/4"	16mm-5/8"	gasket	Multi-Spark	yes	yes		
	AR08ZS	1180		10mm	19mm-3/4"	16mm-5/8"	gasket	Multi-Spark	yes	yes		

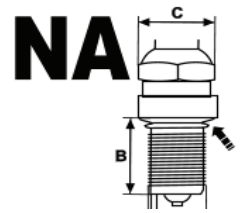

A - M10x1.00  
B - 12.7mm (1/2")  
C - 16mm (5/8")

10-15 Nm  
7-11 lb.ft.

NAR											
silver	..YS	NAR15YS			10mm	12.7mm-1/2"	16mm-5/8"	gasket	Silver Center El.	yes	yes
		NAR14YS			10mm	12.7mm-1/2"	16mm-5/8"	gasket	Silver Center El.	yes	yes
		NAR12YS			10mm	12.7mm-1/2"	16mm-5/8"	gasket	Silver Center El.	yes	yes
premium	NAOR..LGS	NAOR15LGS			10mm	12.7mm-1/2"	16mm-5/8"	gasket	Lamborghini Design	yes	semi
		NAOR14LGS			10mm	12.7mm-1/2"	16mm-5/8"	gasket	Lamborghini Design	yes	semi
		NAOR12LGS			10mm	12.7mm-1/2"	16mm-5/8"	gasket	Lamborghini Design	yes	semi
		NAOR10LGS			10mm	12.7mm-1/2"	16mm-5/8"	gasket	Lamborghini Design	yes	no



**B**

TYP    obj. č.

MANUFACTURER HEAT RANGES						
BRISK	8	10	12	14	15	17
NGK	10	9	8	7	6	5
DENSO	31	27	24	22	20	16



**B**

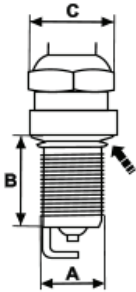

A - M12x1.25  
 B - 19mm (3/4")  
 C - 16mm (5/8")

15-20 Nm  
 11-17 lb.ft. **!**

	TYP	obj. č.	GAP (mm)	MANUFACTURER HEAT RANGES			SEAT	DESIGN	RESISTOR	PROJECTED			
				THREAD	REACH	HEXAGON							
<i>super</i>	..C	B14C	1548	0.7	12mm	19mm-3/4"	18mm-11/16"	gasket	Copper Alloy Electrode	no	no		
		B12C	1547	0.7	12mm	19mm-3/4"	18mm-11/16"	gasket	Copper Alloy Electrode	no	no		
		B10C	1549	0.7	12mm	19mm-3/4"	16mm-5/8"	gasket	Copper/Yttrium Alloy El.	no	no		
		B10C	1511	0.7	12mm	19mm-3/4"	18mm-11/16"	gasket	Copper Alloy Electrode	no	no		
	..YC	B14YC	1487	0.6	12mm	19mm-3/4"	16mm-5/8"	gasket	Copper Alloy Electrode	no	yes		
		B12YC	1469	0.7	12mm	19mm-3/4"	16mm-5/8"	gasket	Copper Alloy Electrode	no	yes		
		BR15YC	1527	0.6	12mm	19mm-3/4"	16mm-5/8"	gasket	Copper Alloy Electrode	yes	yes		
		BR14YC	1526	0.6	12mm	19mm-3/4"	16mm-5/8"	gasket	Copper Alloy Electrode	yes	yes		
		BR14YC-9	1569	0.9	12mm	19mm-3/4"	16mm-5/8"	gasket	Copper Alloy Electrode	yes	yes		
		BR12YC	1523	0.6	12mm	19mm-3/4"	16mm-5/8"	gasket	Copper Alloy Electrode	yes	yes		
		<i>silver</i>	..S	B14S	1504	0.7	12mm	19mm-3/4"	16mm-5/8"	gasket	Silver Center Electrode	no	no
				B12S	1504	0.7	12mm	19mm-3/4"	16mm-5/8"	gasket	Silver Center Electrode	no	no
B10S	1502			0.7	12mm	19mm-3/4"	16mm-5/8"	gasket	Silver Center Electrode	no	no		
B08S				0.7	12mm	19mm-3/4"	16mm-5/8"	gasket	Silver Center Electrode	no	no		
BR14S	1525			0.7	12mm	19mm-3/4"	16mm-5/8"	gasket	Silver Center Electrode	yes	no		
BR12S	1522			0.7	12mm	19mm-3/4"	16mm-5/8"	gasket	Silver Center Electrode	yes	no		
..YS	BR10S		1520		12mm	19mm-3/4"	16mm-5/8"	gasket	Silver Center Electrode	yes	no		
	BR10YS		1509	0.7	12mm	19mm-3/4"	16mm-5/8"	gasket	Silver Center Electrode	yes	yes		
	BR10YS-9		1521	0.9	12mm	19mm-3/4"	16mm-5/8"	gasket	Silver Center Electrode	yes	yes		
	BR12YC-9		1568	0.9	12mm	19mm-3/4"	16mm-5/8"	gasket	Copper Alloy Electrode	yes	yes		
<i>platinum</i>	..YPY	BR12YPY	1524	0.7	12mm	19mm-3/4"	16mm-5/8"	gasket	Platin / Yttrium	yes	yes		
	<i>premium</i>	..LGS	BOR14LGS	3093		12mm	19mm-3/4"	16mm-5/8"	gasket	Lamborghini Design	yes	semi	
BOR12LGS			3092		12mm	19mm-3/4"	16mm-5/8"	gasket	Lamborghini Design	yes	semi		
BOR10LGS			3091		12mm	19mm-3/4"	16mm-5/8"	gasket	Lamborghini Design	no	semi		
..ZS		BR12ZS	1161		12mm	19mm-3/4"	16mm-5/8"	gasket	Multi-Spark	yes	yes		
		BR10ZS	1159		12mm	19mm-3/4"	16mm-5/8"	gasket	Multi-Spark	yes	yes		
		BR08ZS			12mm	19mm-3/4"	16mm-5/8"	gasket	Multi-Spark	yes	yes		
..ZC	BR14ZC	1165		12mm	19mm-3/4"	16mm-5/8"	gasket	Multi-Spark Copper	yes	yes			
	BR12ZC	1163		12mm	19mm-3/4"	16mm-5/8"	gasket	Multi-Spark Copper	yes	yes			



**C**

MANUFACTURER HEAT RANGES						
BRISK	8	10	12	14	15	17
NGK	10	9	8	7	6	5
DENSO	31	27	24	22	20	16



TYP obj. č

THREAD	REACH	HEXAGON	SEAT	DESIGN	RESISTOR	PROJECTED
10mm	26.5mm-1.05"	14mm-9/16"	gasket	Silver Center Electrode	yes	yes

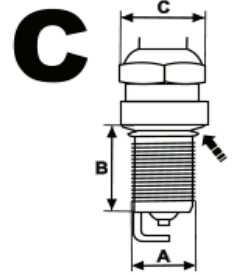

A - M10x1.00  
 B - 26.5mm (1.05")  
 C - 14mm (9/16")

**10-15 Nm**  
**7-11 lb.ft.** **!**







..YS

silver

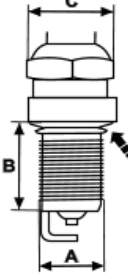
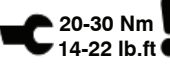
CR10YS





		<b>D</b>		<b>GAP (mm)</b>		<b>MANUFACTURER HEAT RANGES</b>											
						<b>BRISK</b> 8 10 12 14 15 17		<b>NGK</b> 10 9 8 7 6 5		<b>DENSO</b> 31 27 24 22 20 16							
<b>TYP</b>		<b>obj. č.</b>		<b>THREAD</b>		<b>REACH</b>		<b>HEXAGON</b>		<b>SEAT</b>		<b>DESIGN</b>		<b>RESISTOR</b>		<b>PROJECTED</b>	
<b>D</b>  <p> <b>A - M14x1.25</b>  <b>B - 19mm (3/4")</b>  <b>C - 16mm (5/8")</b> </p>  <b>20-30 Nm</b> <b>14-22 lb.ft</b>	<b>extra turbo</b>		DOR..DS	DOR14DS		0.65	14mm	19mm-3/4"	16mm-5/8"	gasket	Dual Ground Electrodes	yes	yes				
			DOR12DS		0.65	14mm	19mm-3/4"	16mm-5/8"	gasket	Dual Ground Electrodes	yes	yes					
			DOR10DS		0.65	14mm	19mm-3/4"	16mm-5/8"	gasket	Dual Ground Electrodes	yes	yes					
			DOR08DS		0.65	14mm	19mm-3/4"	16mm-5/8"	gasket	Dual Ground Electrodes	yes	special-semi					
	<b>extra</b>		DOX..	DOX15LE	1343	0.9	14mm	19mm-3/4"	16mm-5/8"	gasket	Yttrium Electrodes	yes	extra-projected				
			DOX15LE-1	1501	1.1	14mm	19mm-3/4"	16mm-5/8"	gasket	Yttrium Electrodes	yes	extra-projected					
	<b>silver</b>		<b>..S</b>	D12S			14mm	19mm-3/4"	16mm-5/8"	gasket	Silver Center Electrode	no	no				
				D10S			14mm	19mm-3/4"	16mm-5/8"	gasket	Silver Center Electrode	no	no				
				D08S			14mm	19mm-3/4"	16mm-5/8"	gasket	Silver Center Electrode	no	no				
				DR14S	1143		14mm	19mm-3/4"	16mm-5/8"	gasket	Silver Center Electrode	yes	no				
				DR12S	1142		14mm	19mm-3/4"	16mm-5/8"	gasket	Silver Center Electrode	yes	no				
				DR10S			14mm	19mm-3/4"	16mm-5/8"	gasket	Silver Center Electrode	yes	no				
			<b>..YS</b>	DR17YS	1351	0.7	14mm	19mm-3/4"	16mm-5/8"	gasket	Silver Center Electrode	yes	yes				
				DR17YS-9	1463	0.9	14mm	19mm-3/4"	16mm-5/8"	gasket	Silver Center Electrode	yes	yes				
				DR15YS	1334	0.7	14mm	19mm-3/4"	16mm-5/8"	gasket	Silver Center Electrode	yes	yes				
DR15YS-9				1462	0.9	14mm	19mm-3/4"	16mm-5/8"	gasket	Silver Center Electrode	yes	yes					
DR14YS				1352	0.7	14mm	19mm-3/4"	16mm-5/8"	gasket	Silver Center Electrode	yes	yes					
DR14YS-9				1461	0.9	14mm	19mm-3/4"	16mm-5/8"	gasket	Silver Center Electrode	yes	yes					
	<b>DOR..YS</b>	DOR15YS	1302	0.7	14mm	19mm-3/4"	16mm-5/8"	gasket	Silver Center Electrode	yes	yes						
		DOR12YS-1	1553	1.1	14mm	19mm-3/4"	16mm-5/8"	gasket	Silver Center Electrode	yes	yes						

**BRISK**  
 USA ENTERPRISES, LLC







**D**

MANUFACTURER HEAT RANGES						
BRISK	8	10	12	14	15	17
NGK	10	9	8	7	6	5
DENSO	31	27	24	22	20	16

**BRISK**  
USA ENTERPRISES, LLC



TYP obj. č.

GAP (mm)

THREAD REACH HEXAGON SEAT DESIGN RESISTOR PROJECTED

**D**

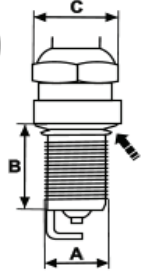

A - M14x1.25  
B - 19mm (3/4")  
C - 16mm (5/8")

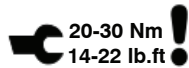

platinum

	..YP	DR17YP	1402	0.8	14mm	19mm-3/4"	16mm-5/8"	gasket	Double Platinum	yes	yes
		DR17YP-1	1403	1.1	14mm	19mm-3/4"	16mm-5/8"	gasket	Double Platinum	yes	yes
		DR15YP	1400	0.8	14mm	19mm-3/4"	16mm-5/8"	gasket	Double Platinum	yes	yes
		DR15YP-1	1401	1.1	14mm	19mm-3/4"	16mm-5/8"	gasket	Double Platinum	yes	yes
		DR14YP	1425	0.8	14mm	19mm-3/4"	16mm-5/8"	gasket	Double Platinum	yes	yes
		DR14YP-1	1426	1.1	14mm	19mm-3/4"	16mm-5/8"	gasket	Double Platinum	yes	yes
		DR12YP	1508	0.8	14mm	19mm-3/4"	16mm-5/8"	gasket	Double Platinum	yes	yes

premium

	..LGS	DOR17LGS	3027		14mm	19mm-3/4"	16mm-5/8"	gasket	Lamborghini Design	yes	yes
		DOR15LGS	3026		14mm	19mm-3/4"	16mm-5/8"	gasket	Lamborghini Design	yes	yes
		DOR15LGS-T			14mm	19mm-3/4"	16mm-5/8"	gasket	Lambo Design small gap	yes	yes
		DOR14LGS	3025		14mm	19mm-3/4"	16mm-5/8"	gasket	Lamborghini Design	yes	yes
		DOR14LGS-T			14mm	19mm-3/4"	16mm-5/8"	gasket	Lambo Design small gap	yes	yes
		DOR12LGS	3032		14mm	19mm-3/4"	16mm-5/8"	gasket	Lamborghini Design	yes	yes
		DOR11LGS			14mm	19mm-3/4"	16mm-5/8"	gasket	Lamborghini Design	yes	no
		DOR10LGS			14mm	19mm-3/4"	16mm-5/8"	gasket	Lamborghini Design	yes	no
		DO 10LGS-T			14mm	19mm-3/4"	16mm-5/8"	gasket	Lambo Design small gap	no	no
		DOR08LGS			14mm	19mm-3/4"	16mm-5/8"	gasket	Lamborghini Design	yes	no

	..ZC	DR15ZC	1126		14mm	19mm-3/4"	16mm-5/8"	gasket	Multi-Spark	yes	yes
		DR15ZC-1	1134		14mm	19mm-3/4"	16mm-5/8"	gasket	Multi-Spark	yes	yes
		DR14ZC	1124		14mm	19mm-3/4"	16mm-5/8"	gasket	Multi-Spark	yes	yes
		DR14ZC-1	1232		14mm	19mm-3/4"	16mm-5/8"	gasket	Multi-Spark	yes	yes
		DR12ZC	1125		14mm	19mm-3/4"	16mm-5/8"	gasket	Multi-Spark	yes	yes
		DR12ZC-1	1133		14mm	19mm-3/4"	16mm-5/8"	gasket	Multi-Spark	yes	yes
		DR10ZC	1130		14mm	19mm-3/4"	16mm-5/8"	gasket	Multi-Spark	yes	yes
		DR10ZC-1	1135		14mm	19mm-3/4"	16mm-5/8"	gasket	Multi-Spark	yes	yes

	..ZS	DR12ZS	1204		14mm	19mm-3/4"	16mm-5/8"	gasket	Multi-Spark	yes	yes
		DR10ZS	1203		14mm	19mm-3/4"	16mm-5/8"	gasket	Multi-Spark	yes	yes
		DR08ZS	1202		14mm	19mm-3/4"	16mm-5/8"	gasket	Multi-Spark	yes	yes

	..GS	DR08GS			14mm	19mm-3/4"	16mm-5/8"	gasket	Surface Discharge	yes	no
--	------	--------	--	--	------	-----------	-----------	--------	-------------------	-----	----

iridium

	..IR	DOR15IR	1442	0.8	14mm	19mm-3/4"	16mm-5/8"	gasket	Iridium Center Electrode	yes	special-semi
		DOR14IR	1441	0.8	14mm	19mm-3/4"	16mm-5/8"	gasket	Iridium Center Electrode	yes	special-semi
		DOR12IR			14mm	19mm-3/4"	16mm-5/8"	gasket	Iridium Center Electrode	yes	special-semi
		DOR10IR			14mm	19mm-3/4"	16mm-5/8"	gasket	Iridium Center Electrode	yes	special-semi
		DOR08IR			14mm	19mm-3/4"	16mm-5/8"	gasket	Iridium Center Electrode	yes	special-semi
		DOX12IRY			14mm	19mm-3/4"	16mm-5/8"	gasket	Iridium / Yttrium	yes	extra projected



**E**

TYP | obj. č.

GAP (mm)

MANUFACTURER HEAT RANGES						
BRISK	8	10	12	14	15	17
NGK	10	9	8	7	6	5
DENSO	31	27	24	22	20	16



THREAD | REACH | HEXAGON | SEAT | DESIGN | RESISTOR | PROJECTED

**E**

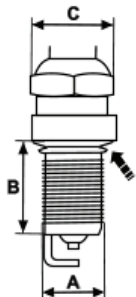

A - M14x1.25  
B - 26.5mm (1.05")  
C - 16mm (5/8")

20-30 Nm  
14-22 lb.ft !

super



..YC  
ER15YC-1

14mm | 26.5mm-1.05" | 16mm-5/8" | gasket | Copper Center Electrode | yes | yes

silver

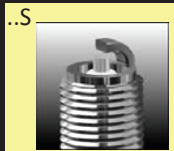

..S  
ER14S  
ER12S  
ER10S

14mm | 26.5mm-1.05" | 16mm-5/8" | gasket | Silver Center Electrode | yes | no  
14mm | 26.5mm-1.05" | 16mm-5/8" | gasket | Silver Center Electrode | yes | no  
14mm | 26.5mm-1.05" | 16mm-5/8" | gasket | Silver Center Electrode | yes | no



..YS  
ER14YS  
ER15YS

14mm | 26.5mm-1.05" | 16mm-5/8" | gasket | Silver Center Electrode | yes | yes  
14mm | 26.5mm-1.05" | 16mm-5/8" | gasket | Silver Center Electrode | yes | yes

premium



..LGS  
EOR15LGS  
EOR14LGS

14mm | 26.5mm-1.05" | 16mm-5/8" | gasket | Lamborghini Design | yes | yes  
14mm | 26.5mm-1.05" | 16mm-5/8" | gasket | Lamborghini Design | yes | yes



<b>G</b>		MANUFACTURER HEAT RANGES							
		BRISK	8	10	12	14	15	17	
TYP		obj. č.	GAP (mm)						
			BRISK	10	9	8	7	6	5
			DENSO	31	27	24	22	20	16

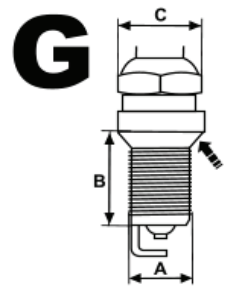

A - M14x1.25  
 B - 18mm (.708")  
 C - 16mm (5/8")

**20-30 Nm**  
**14-22 lb.ft**

	TYP	obj. č.	GAP (mm)	MANUFACTURER HEAT RANGES			SEAT	DESIGN	RESISTOR	PROJECTED		
				BRISK	NGK	DENSO						
				THREAD	REACH	HEXAGON						
<b>super</b>	..YC		G17YC	1368	0.7	14mm	18mm-.708"	16mm-5/8"	tapered	Copper Alloy Electrode	no	yes
			G15YC	1336	0.7	14mm	18mm-.708"	16mm-5/8"	tapered	Copper Alloy Electrode	no	yes
			G14YC	1376	0.7	14mm	18mm-.708"	16mm-5/8"	tapered	Copper Alloy Electrode	no	yes
			G12YC	1483	0.7	14mm	18mm-.708"	16mm-5/8"	tapered	Copper Alloy Electrode	no	yes
			GR19YC-1	1477	1.1	14mm	18mm-.708"	16mm-5/8"	tapered	Copper Alloy Electrode	yes	yes
			GR17YC	1389	0.7	14mm	18mm-.708"	16mm-5/8"	tapered	Copper Alloy Electrode	yes	yes
			GR17YC-1	1419	1.1	14mm	18mm-.708"	16mm-5/8"	tapered	Copper Alloy Electrode	yes	yes
			GR15YC	1362	0.7	14mm	18mm-.708"	16mm-5/8"	tapered	Copper Alloy Electrode	yes	yes
			GR15YC-1	1383	1.1	14mm	18mm-.708"	16mm-5/8"	tapered	Copper Alloy Electrode	yes	yes
			GR14YC	1378	0.7	14mm	18mm-.708"	16mm-5/8"	tapered	Copper Alloy Electrode	yes	yes
<b>silver</b>	..S		G12S			14mm	18mm-.708"	16mm-5/8"	tapered	Silver Center Electrode	no	no
			G08S			14mm	18mm-.708"	16mm-5/8"	tapered	Silver Center Electrode	no	no
			GR14S	1493	0.7	14mm	18mm-.708"	16mm-5/8"	tapered	Silver Center Electrode	yes	no
	..YS		GR12S			14mm	18mm-.708"	16mm-5/8"	tapered	Silver Center Electrode	yes	no
			G14YS	1492	0.7	14mm	18mm-.708"	16mm-5/8"	tapered	Silver Center Electrode	no	yes
			GR17YS			14mm	18mm-.708"	16mm-5/8"	tapered	Silver Center Electrode	yes	yes
			GR15YS			14mm	18mm-.708"	16mm-5/8"	tapered	Silver Center Electrode	yes	yes
GR14YS			14mm	18mm-.708"	16mm-5/8"	tapered	Silver Center Electrode	yes	yes			
GR15YS-9	1577		14mm	18mm-.708"	16mm-5/8"	tapered	Silver Center Electrode	yes	yes			
<b>platinum</b>	..YP		GR19YP-5	1478	1.5	14mm	18mm-.708"	16mm-5/8"	tapered	Single Platin	yes	yes
			GR17YP-5	1475	1.5	14mm	18mm-.708"	16mm-5/8"	tapered	Single Platin	yes	yes
			GR17YP-3	1474	1.3	14mm	18mm-.708"	16mm-5/8"	tapered	Single Platin	yes	yes
			GR17LP-5	1479	1.5	14mm	18mm-.708"	16mm-5/8"	tapered	Single Platin Extra Proj.	yes	yes
			GR15YP-1			14mm	18mm-.708"	16mm-5/8"	tapered	Single Platin	yes	yes
<b>premium</b>	..LGS		GOR19LGS	3083		14mm	18mm-.708"	16mm-5/8"	tapered	Lamborghini Design	yes	yes
			GOR17LGS			14mm	18mm-.708"	16mm-5/8"	tapered	Lamborghini Design	yes	yes
			GOR15LGS			14mm	18mm-.708"	16mm-5/8"	tapered	Lamborghini Design	yes	yes
			GOR15LGS-T			14mm	18mm-.708"	16mm-5/8"	tapered	Lambo Design small gap	yes	yes
			GOR14LGS	3080		14mm	18mm-.708"	16mm-5/8"	tapered	Lamborghini Design	yes	yes
			GOR14LGS-T			14mm	18mm-.708"	16mm-5/8"	tapered	Lambo Design small gap	yes	yes
			GO11LGS-T			14mm	18mm-.708"	16mm-5/8"	tapered	Lambo Design small gap	no	no
	..ZC		GR15ZC	1155		14mm	18mm-.708"	16mm-5/8"	tapered	Multi-Spark	yes	yes
			GR15ZC-1	1158		14mm	18mm-.708"	16mm-5/8"	tapered	Multi-Spark	yes	yes
			GR14ZC	1153		14mm	18mm-.708"	16mm-5/8"	tapered	Multi-Spark	yes	yes
<b>extra</b>	..TC		GR14ZC-1	1157		14mm	18mm-.708"	16mm-5/8"	tapered	Multi-Spark	yes	yes
			GR12ZC	1152		14mm	18mm-.708"	16mm-5/8"	tapered	Multi-Spark	yes	yes
GR12ZC-1	1156		14mm	18mm-.708"	16mm-5/8"	tapered	Multi-Spark	yes	yes			
GOR15YTE-3			1.3	14mm	18mm-.708"	16mm-5/8"	tapered	Triple Ground El. Yttrium	yes	yes		
GO15YTE-1			1.1	14mm	18mm-.708"	16mm-5/8"	tapered	Triple Ground El. Yttrium	no	yes		
GOR14DC				14mm	18mm-.708"	16mm-5/8"	tapered	Dual Ground El. Copper	yes	yes		



<b>H</b>		GAP (mm)	MANUFACTURER HEAT RANGES					
			BRISK	8	10	12	14	15
NGK	10		9	8	7	6	5	
DENSO	31	27	24	22	20	16		
TYP	obj. č.							



**H**

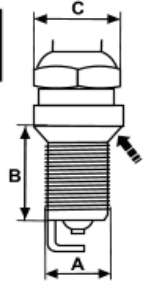

A - M14x1.25  
 B - 12.7mm (1/2")  
 C - 16mm (5/8")

10-20 Nm  
 7-14 lb.ft.

				THREAD	REACH	HEXAGON	SEAT	DESIGN	RESISTOR	PROJECTED	
<i>extra</i>	..YTE	HOR17YTE-1	3084	14mm	12.7mm-1/2"	16mm-5/8"	tapered	Copper Yttrium -Stubby	yes	yes	
		HR17YTE-1		14mm	12.7mm-1/2"	16mm-5/8"	tapered	Copper Yttrium -Stubby	yes	yes	
		HO15YTE-1		14mm	12.7mm-1/2"	16mm-5/8"	tapered	Copper Yttrium -Stubby	no	yes	
	<i>silver</i>	..YS	HR14YS		14mm	12.7mm-1/2"	16mm-5/8"	tapered	Silver Center Electrode	yes	yes
			H14YS		14mm	12.7mm-1/2"	16mm-5/8"	tapered	Silver Center Electrode	no	yes
			H08S		14mm	12.7mm-1/2"	16mm-5/8"	tapered	Silver Center Electrode	no	no
	<i>premium</i>	..LGS	HOR11LGS	3084	14mm	12.7mm-1/2"	16mm-5/8"	tapered	Lamborghini Design	yes	no
			HOR14LGS	3085	14mm	12.7mm-1/2"	16mm-5/8"	tapered	Lamborghini Design	yes	yes
			HOR17LGS	3086	14mm	12.7mm-1/2"	16mm-5/8"	tapered	Lamborghini Design	yes	yes
			HOR15LGS		14mm	12.7mm-1/2"	16mm-5/8"	tapered	Lamborghini Design	yes	yes
			HOR12LGS		14mm	12.7mm-1/2"	16mm-5/8"	tapered	Lamborghini Design	yes	yes
			HO14LGS		14mm	12.7mm-1/2"	16mm-5/8"	tapered	Lamborghini Design	no	yes
HO12LGS		14mm	12.7mm-1/2"	16mm-5/8"	tapered	Lamborghini Design	no	yes			
HO11LGS-T		14mm	12.7mm-1/2"	16mm-5/8"	tapered	Lambo Design small	no	no			



<b>L</b>		GAP (mm)	MANUFACTURER HEAT RANGES					
			BRISK	8	10	12	14	15
NGK	10		9	8	7	6	5	
DENSO	31	27	24	22	20	16		
TYP	obj. č.							

**L**

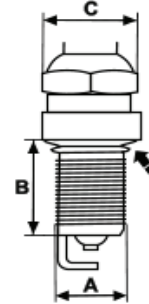

A - M14x1.25  
 B - 19mm (3/4")  
 C - 21mm (13/16")

20-30 Nm  
 14-22 lb.ft.

				THREAD	REACH	HEXAGON	SEAT	DESIGN	RESISTOR	PROJECTED	
<i>super</i>	..C	L17C	1321	0.7	14mm	19mm-3/4"	21mm-13/16"	gasket	Copper Alloy Electrode	no	no
		L15C	1468	0.7	14mm	19mm-3/4"	21mm-13/16"	gasket	Copper Alloy Electrode	no	no
		L14C	1344	0.7	14mm	19mm-3/4"	21mm-13/16"	gasket	Copper Alloy Electrode	no	no
		LR17C	1473	0.7	14mm	19mm-3/4"	21mm-13/16"	gasket	Copper Alloy Electrode	yes	no
		LR15C	1472	0.7	14mm	19mm-3/4"	21mm-13/16"	gasket	Copper Alloy Electrode	yes	no
		LR14C	1485	0.7	14mm	19mm-3/4"	21mm-13/16"	gasket	Copper Alloy Electrode	yes	no
	LR12C	1536	0.7	14mm	19mm-3/4"	21mm-13/16"	gasket	Copper Alloy Electrode	yes	no	
	..YC	L17YC	1338	0.7	14mm	19mm-3/4"	21mm-13/16"	gasket	Copper Alloy Electrode	no	yes
		L17YC-1	1224	1.1	14mm	19mm-3/4"	21mm-13/16"	gasket	Copper Alloy Electrode	no	yes
		L15YC	1313	0.7	14mm	19mm-3/4"	21mm-13/16"	gasket	Copper Alloy Electrode	no	yes
		L15YC-1	1429	1.1	14mm	19mm-3/4"	21mm-13/16"	gasket	Copper Alloy Electrode	no	yes
		L14YC	1361	0.7	14mm	19mm-3/4"	21mm-13/16"	gasket	Copper Alloy Electrode	no	yes
		L12YC	1484	0.7	14mm	19mm-3/4"	21mm-13/16"	gasket	Copper Alloy Electrode	no	yes
		LR17YC	1322	0.7	14mm	19mm-3/4"	21mm-13/16"	gasket	Copper Alloy Electrode	yes	yes
		LR17YC-1	1365	1.1	14mm	19mm-3/4"	21mm-13/16"	gasket	Copper Alloy Electrode	yes	yes
		LR17YC-9	1573	0.9	14mm	19mm-3/4"	21mm-13/16"	gasket	Copper Alloy Electrode	yes	yes
		LR15YC	1314	0.7	14mm	19mm-3/4"	21mm-13/16"	gasket	Copper Alloy Electrode	yes	yes
		LR15YC-1	1315	1.1	14mm	19mm-3/4"	21mm-13/16"	gasket	Copper Alloy Electrode	yes	yes
LR15YC-9		1572	0.9	14mm	19mm-3/4"	21mm-13/16"	gasket	Copper Alloy Electrode	yes	yes	
LR14YC	1370	0.7	14mm	19mm-3/4"	21mm-13/16"	gasket	Copper Alloy Electrode	yes	yes		
LR12YC	1413	0.7	14mm	19mm-3/4"	21mm-13/16"	gasket	Copper Alloy Electrode	yes	yes		



**L**

**MANUFACTURER HEAT RANGES**

BRISK	8	10	12	14	15	17
NGK	10	9	8	7	6	5
DENSO	31	27	24	22	20	16

**BRISK**  
USA ENTERPRISES, LLC



TYP obj. č.

GAP (mm)

**THREAD REACH HEXAGON SEAT DESIGN RESISTOR PROJECTED**

**L**

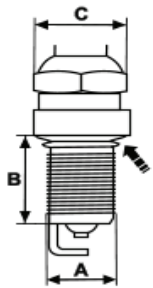

A - M14x1.25  
B - 19mm (3/4")  
C - 21mm (13/16")

**20-30 Nm**  
**14-22 lb.ft**

*extra-pokra*

..LTC



LR15LTC

1268

0.8

14mm 19mm-3/4" 21mm-13/16"

gasket

Copper Elect. Ext. Proj.  
Triple Ground Electrodes

yes

yes

*silver*

..S

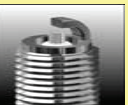

LR12S

1530

0.6

14mm 19mm-3/4" 21mm-13/16"

gasket

Silver Center Electrode

no

no

LR11S

1531

0.6

14mm 19mm-3/4" 21mm-13/16"

gasket

Silver Center Electrode

no

no

LR11SL

1528

0.6

14mm 19mm-3/4" 21mm-13/16"

gasket

Silver El. ISO-Length Insulator

no

no

LR10S

1529

0.6

14mm 19mm-3/4" 21mm-13/16"

gasket

Silver Center Electrode

no

no

LR10SL

1147

0.7

14mm 19mm-3/4" 21mm-13/16"

gasket

Silver Center Electrode

yes

no

LR14S

1555

0.7

14mm 19mm-3/4" 21mm-13/16"

gasket

Silver Center Electrode

yes

no

LR12S

1145

0.7

14mm 19mm-3/4" 21mm-13/16"

gasket

Silver Center Electrode

yes

no

LR12SL

1537

0.6

14mm 19mm-3/4" 21mm-13/16"

gasket

Silver El. ISO-Length Insulator

yes

no

LR11S

1534

0.6

14mm 19mm-3/4" 21mm-13/16"

gasket

Silver Center Electrode

yes

no

LR11SL

1535

0.6

14mm 19mm-3/4" 21mm-13/16"

gasket

Silver El. ISO-Length Insulator

yes

no

LR10S

1532

0.6

14mm 19mm-3/4" 21mm-13/16"

gasket

Silver Center Electrode

yes

no

LR10SL

1533

0.6

14mm 19mm-3/4" 21mm-13/16"

gasket

Silver El. ISO-Length Insulator

yes

no

..YS



LR17YS

1333

0.7

14mm 19mm-3/4" 21mm-13/16"

gasket

Silver Center Electrode

yes

yes

LR17YS-9

1465

0.9

14mm 19mm-3/4" 21mm-13/16"

gasket

Silver Center Electrode

yes

yes

LR15YS

1332

0.7

14mm 19mm-3/4" 21mm-13/16"

gasket

Silver Center Electrode

yes

yes

LR15YS-9

1464

0.9

14mm 19mm-3/4" 21mm-13/16"

gasket

Silver Center Electrode

yes

yes

LR14YS

1353

0.7

14mm 19mm-3/4" 21mm-13/16"

gasket

Silver Center Electrode

yes

yes

LR12YS

1458

0.7

14mm 19mm-3/4" 21mm-13/16"

gasket

Silver Center Electrode

yes

yes



**L**

**MANUFACTURER HEAT RANGES**

BRISK	8	10	12	14	15	17
NGK	10	9	8	7	6	5
DENSO	31	27	24	22	20	16

**BRISK**  
USA ENTERPRISES, LLC



TYP obj. č.

GAP (mm)

				THREAD	REACH	HEXAGON	SEAT	DESIGN	RESISTOR	PROJECTED	
<p>A - M14x1.25 B - 19mm (3/4") C - 21mm (13/16")</p>	<b>premium</b>	..LGS	LOR17LGS	3030	14mm	19mm-3/4"	21mm-13/16"	gasket	Lamborghini Design	yes	yes
		LOR15LGS	3029	14mm	19mm-3/4"	21mm-13/16"	gasket	Lamborghini Design	yes	yes	
		LOR14LGS	3028	14mm	19mm-3/4"	21mm-13/16"	gasket	Lamborghini Design	yes	yes	
		LOR12LGS	3034	14mm	19mm-3/4"	21mm-13/16"	gasket	Lamborghini Design	yes	yes	
		..ZC	LR15ZC	1129	14mm	19mm-3/4"	21mm-13/16"	gasket	Multi-Spark	yes	yes
		LR15ZC-1	1138	1.1	14mm	19mm-3/4"	21mm-13/16"	gasket	Multi-Spark	yes	yes
		LR14ZC	1127	14mm	19mm-3/4"	21mm-13/16"	gasket	Multi-Spark	yes	yes	
		LR14ZC-1	1136	1.1	14mm	19mm-3/4"	21mm-13/16"	gasket	Multi-Spark	yes	yes
		LR12ZC	1128	14mm	19mm-3/4"	21mm-13/16"	gasket	Multi-Spark	yes	yes	
		LR12ZC-1	1137	1.1	14mm	19mm-3/4"	21mm-13/16"	gasket	Multi-Spark	yes	yes
		LR10ZC	1131	14mm	19mm-3/4"	21mm-13/16"	gasket	Multi-Spark	yes	yes	
		LR10ZC-1	1139	1.1	14mm	19mm-3/4"	21mm-13/16"	gasket	Multi-Spark	yes	yes
		..ZS	L10ZS		14mm	19mm-3/4"	21mm-13/16"	gasket	Multi-Spark	no	yes
LR12ZS	1207	14mm	19mm-3/4"	21mm-13/16"	gasket	Multi-Spark	yes	yes			
LR10ZS	1206	14mm	19mm-3/4"	21mm-13/16"	gasket	Multi-Spark	yes	yes			
LR08ZS	1205	14mm	19mm-3/4"	21mm-13/16"	gasket	Multi-Spark	yes	yes			



**M**

MANUFACTURER HEAT RANGES						
BRISK	8	10	12	14	15	17
NGK	10	9	8	7	6	5
DENSO	31	27	24	22	20	16



TYP obj. č.

GAP (mm)

THREAD	REACH	HEXAGON	SEAT	DESIGN	RESISTOR	PROJECTED
12mm	26.5mm-1.05"	14mm-9/16"	gasket	Silver Center Electrode	yes	no
12mm	26.5mm-1.05"	14mm-9/16"	gasket	Silver Center Electrode	yes	no

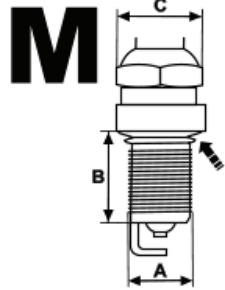

A - M12x1.25  
 B - 26.5mm (1.05")  
 C - 14mm (9/16")

15-20 Nm  
 11-14 lb.ft

silver

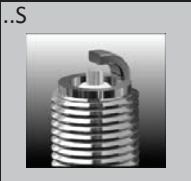

MR12S  
 MR10S

MR12YS-1  
 MR12YS-9  
 MR10YS

1.1

0.9

12mm	26.5mm-1.05"	14mm-9/16"	gasket	Silver Center Electrode	yes	yes
12mm	26.5mm-1.05"	14mm-9/16"	gasket	Silver Center Electrode	yes	yes
12mm	26.5mm-1.05"	14mm-9/16"	gasket	Silver Center Electrode	yes	yes











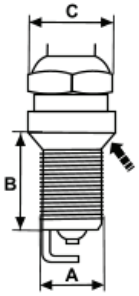

<b>N</b>		GAP (mm)	MANUFACTURER HEAT RANGES								
			BRISK	8	10	12	14	15	17		
NGK	10		9	8	7	6	5				
DENSO	31		27	24	22	20	16				
TYP	obj. č.										



		THREAD	REACH	HEXAGON	SEAT	DESIGN	RESISTOR	PROJECTED				
<p><b>N</b></p> <p>A - M14x1.25 B - 12.7mm (1/2") C - 21mm (13/16")</p> <p> 20-30 Nm 14-22 lb.ft.!</p>	<i>super</i>	..C										
			N19C	1363	0.7	14mm	12.7mm-1/2"	21mm-13/16"	gasket	Copper Alloy Electrode	no	no
			N17C	1320	0.7	14mm	12.7mm-1/2"	21mm-13/16"	gasket	Copper Alloy Electrode	no	no
			N15C	1330	0.7	14mm	12.7mm-1/2"	21mm-13/16"	gasket	Copper Alloy Electrode	no	no
			N14C	1319	0.7	14mm	12.7mm-1/2"	21mm-13/16"	gasket	Copper Alloy Electrode	no	no
			N12C	1467	0.7	14mm	12.7mm-1/2"	21mm-13/16"	gasket	Copper Alloy Electrode	no	no
			NR14C	1434	0.7	14mm	12.7mm-1/2"	21mm-13/16"	gasket	Copper Alloy Electrode	yes	no
			NR15C	1386	0.7	14mm	12.7mm-1/2"	21mm-13/16"	gasket	Copper Alloy Electrode	yes	no
			NR17C	1371	0.7	14mm	12.7mm-1/2"	21mm-13/16"	gasket	Copper Alloy Electrode	yes	no
			..YC									
			N17YC	1544	0.7	14mm	12.7mm-1/2"	21mm-13/16"	gasket	Copper Alloy Electrode	no	yes
			N15YC	1341	0.7	14mm	12.7mm-1/2"	21mm-13/16"	gasket	Copper Alloy Electrode	no	yes
			N14YC	1360	0.7	14mm	12.7mm-1/2"	21mm-13/16"	gasket	Copper Alloy Electrode	no	yes
			N12YC	1430	0.7	14mm	12.7mm-1/2"	21mm-13/16"	gasket	Copper Alloy Electrode	no	yes
	NR17YC	1340	0.7	14mm	12.7mm-1/2"	21mm-13/16"	gasket	Copper Alloy Electrode	yes	yes		
	NR15YC	1339	0.7	14mm	12.7mm-1/2"	21mm-13/16"	gasket	Copper Alloy Electrode	yes	yes		
	NR14YC	1387	0.7	14mm	12.7mm-1/2"	21mm-13/16"	gasket	Copper Alloy Electrode	yes	yes		
	NR12YC	1486	0.7	14mm	12.7mm-1/2"	21mm-13/16"	gasket	Copper Alloy Electrode	yes	yes		
	..S											
<i>silver</i>		N10S	1538	0.6	14mm	12.7mm-1/2"	21mm-13/16"	gasket	Silver Center Electrode	no	no	
	N11S	1539	0.6	14mm	12.7mm-1/2"	21mm-13/16"	gasket	Silver Center Electrode	no	semi		
	NR15S	1354	0.55	14mm	12.7mm-1/2"	21mm-13/16"	gasket	Silver Center Electrode	yes	no		
	NR14S	1432	0.55	14mm	12.7mm-1/2"	21mm-13/16"	gasket	Silver Center Electrode	yes	no		
	NR12S	1471	0.55	14mm	12.7mm-1/2"	21mm-13/16"	gasket	Silver Center Electrode	yes	no		
	LGS											
<i>premium</i>		NOR15LGS	3068		14mm	12.7mm-1/2"	21mm-13/16"	gasket	Lamborghini Design	yes	yes	
	NOR14LGS			14mm	12.7mm-1/2"	21mm-13/16"	gasket	Lamborghini Design	yes	yes		
	NOR12LGS			14mm	12.7mm-1/2"	21mm-13/16"	gasket	Lamborghini Design	yes	yes		

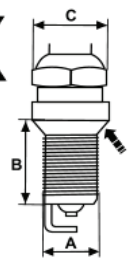

		<h1 style="text-align: center;">R</h1>		<b>GAP (mm)</b>		<b>MANUFACTURER HEAT RANGES</b>						
						<b>BRISK</b> 8   10   12   14   15   17 <b>NGK</b> 10   9   8   7   6   5 <b>DENSO</b> 31   27   24   22   20   16						
<b>TYP</b> <b>obj. č.</b>						<b>THREAD</b>	<b>REACH</b>	<b>HEXAGON</b>	<b>SEAT</b>	<b>DESIGN</b>	<b>RESISTOR</b>	<b>PROJECTED</b>
<h1 style="font-size: 4em;">R</h1>  <p> <b>A - M14x1.25</b>  <b>B - 25mm (1")</b>  <b>C - 16mm (5/8")</b> </p> <p>  <b>10-20 Nm</b>  <b>7-14 lb.ft. !</b> </p>	<b>super</b>	..YC 	<b>RR15YC-1</b> 1437 <b>RR15YPP-1</b>	<b>1.1</b>	14mm	25mm-1"	16mm-5/8"	tapered	Yttrium Alloy Electrode	yes	yes	
		14mm	25mm-1"		16mm-5/8"	tapered	Double Platinum	yes	yes			
	<b>silver</b>	..S 	<b>RR14S</b> <b>RR12S</b> <b>RR10S</b>		14mm	25mm-1"	16mm-5/8"	tapered	Silver Center Electrode	yes	no	
		14mm	25mm-1"	16mm-5/8"	tapered	Silver Center Electrode	yes	no				
		14mm	25mm-1"	16mm-5/8"	tapered	Silver Center Electrode	yes	no				
	..YS 	<b>RR15YS</b> <b>RR14YS</b>		14mm	25mm-1"	16mm-5/8"	tapered	Silver Center Electrode	yes	yes		
	14mm	25mm-1"	16mm-5/8"	tapered	Silver Center Electrode	yes	yes					
	<b>premium</b>	..LGS 	<b>ROR15LGS</b> <b>ROR14LGS</b>		14mm	25mm-1"	16mm-5/8"	tapered	Lamborghini Design	yes	yes	
		14mm	25mm-1"	16mm-5/8"	tapered	Lamborghini Design	yes	yes				
			<h1 style="text-align: center;">X</h1>		<b>GAP (mm)</b>		<b>MANUFACTURER HEAT RANGES</b>					
<b>BRISK</b> 8   10   12   14   15   17 <b>NGK</b> 10   9   8   7   6   5 <b>DENSO</b> 31   27   24   22   20   16												
<b>TYP</b> <b>obj. č.</b>						<b>THREAD</b>	<b>REACH</b>	<b>HEXAGON</b>	<b>SEAT</b>	<b>DESIGN</b>	<b>RESISTOR</b>	<b>PROJECTED</b>
<h1 style="font-size: 4em;">X</h1>  <p> <b>A - M12x1.25</b>  <b>B - 27mm (1.05")</b>  <b>C - 14mm (9/16")</b> </p> <p>  <b>10-12 Nm</b>  <b>7- 9 lb.ft. !</b> </p>	<b>silver</b>	..YS 	<b>XOR14YS</b> <b>XOR14YS-1</b> <b>XOR12YS</b> <b>XOR12YS-1</b>		12mm	27mm-1.05"	14mm-9/16"	tapered	Silver Center Electrode	yes	yes	
		1.0	12mm	27mm-1.05"	14mm-9/16"	tapered	Silver Center Electrode	yes	yes			
		1.0	12mm	27mm-1.05"	14mm-9/16"	tapered	Silver Center Electrode	yes	yes			
		1.0	12mm	27mm-1.05"	14mm-9/16"	tapered	Silver Center Electrode	yes	yes			
		1.0	12mm	27mm-1.05"	14mm-9/16"	tapered	Silver Center Electrode	yes	yes			

# SPARK PLUG CROSS REFERENCE GUIDE

BOSCH	BRISK
F6DC F6DTC FR6DTC FR6DC F6DP F6DSR FR6DS	<b>DR14YS</b>

BOSCH	BRISK
F7DC FR7LDC F7DTC FR7DTC FR7DC FR7DP	<b>DR15YS</b>

BOSCH	BRISK
F8DC F9DC FR8LDC FR8DC FR9DC FR8DS	<b>DR17YS</b>

F6DTC F6LTCR FR6DCX	<b>DR14YS-9</b>
---------------------------	-----------------

F7DCX F7LDCR FR7DCX FR7DPX F7LTCR FR7LTC	<b>DR15YS-9</b>
---	-----------------

F8LDCR FR8DCX FR8DPX	<b>DR17YS-9</b>
----------------------------	-----------------

BOSCH	BRISK
W6DC W6DTC WR6DTC WR6DC WR6DP W5CS WR6DS	<b>LR14YS</b>

BOSCH	BRISK
W7DC W7DTC WR7DTC WR7DC WR7DP W7DSR WR7DS	<b>LR15YS</b>

BOSCH	BRISK
W8DC W9DC W8DTC W8LTCR W9DTC WR8DC WR9DC WR8DP WR9DP WR8DS WR9DS	<b>LR17YS</b>

W7DTC WR7DCX WR7DPX W7LTCR	<b>LR15YS-9</b>
-------------------------------------	-----------------

W8DTC W8LTCR WR8DCX WR8DPX WR9DPX	<b>LR17YS-9</b>
---	-----------------

BOSCH	BRISK
W4AC W5AC W6BC WR6BC	<b>NR14S</b>

BOSCH	BRISK
W7AC W7BC WR7AC WR7BC	<b>NR15C</b>

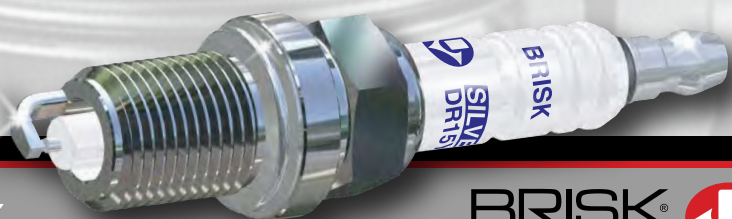

**Silver**

**BRISK**  
USA ENTERPRISES, LLC



# SPARK PLUG CROSS REFERENCE GUIDE

CHAMPION	BRISK
C6BYC C7YCC RC7BYC RC7YCC RC8PYP RC8YCC	<b>DR14YS</b>

CHAMPION	BRISK
C9YC C9YCC C10YCC RC8DMC RC87PYC RC89PYC RC9YC RC9YCC RC10YCC	<b>DR15YS</b>

CHAMPION	BRISK
C11YC C11YCC C12YC C12YCC RC10PYC RC12PYP RC12YC RC12YCC	<b>DR17YS</b>

RC7BYC4 RC7YCC4 RC8PYPB4	<b>DR14YS-9</b>
--------------------------------	-----------------

RC8VTYC4 RC9YC4 RC9YCC4	<b>DR15YS-9</b>
-------------------------------	-----------------

RC10PYP4 RC10VTYC4 RC11PYPB4 RC12YC4 RC12YCC4	<b>DR17YS-9</b>
---	-----------------

CHAMPION	BRISK
N279YC N7BYC N7GY N7YC N7YCC RN7YC RN7YCC	<b>LR14YS</b>

CHAMPION	BRISK
N281YC N8GY N9BYC N9YC RN9GY RN9YC RN9YCC	<b>LR15YS</b>

CHAMPION	BRISK
N11YC N12YC N14YC RN10VTYC RN11YC RN11YCC	<b>LR17YS</b>

N9BYC4 RN8VTYC4 RN9YCC4	<b>LR15YS-9</b>
-------------------------------	-----------------

RN10VTYC4 RN11YCC4	<b>LR17YS-9</b>
-----------------------	-----------------

CHAMPION	BRISK
L78C L82YC RL82YCC	<b>NR14S</b>

CHAMPION	BRISK
L82C L87YC L87YCC RL82CC RL87YC RL87YCC	<b>NR15S</b>

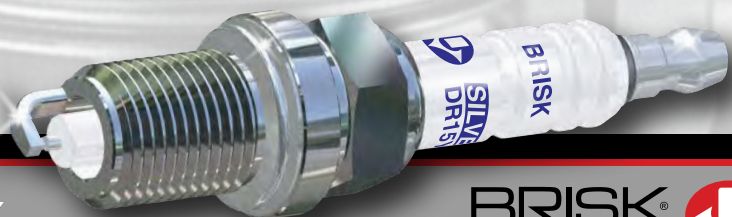

**Silver**

**BRISK**  
USA ENTERPRISES, LLC



# SPARK PLUG CROSS REFERENCE GUIDE

NGK	BRISK
BCP7E	<b>DR14YS</b>
BCP7ES	
BCP7ET	
BCPR7E	
BCPR7ES	
BCPR7ET	
BCPR7EY	
BKR7E	
BKR7E-N	
BKR7ES	
BKR7EY	
BKUR7ET	
PFR7B	
PFR7G	
PFR7G-9	
PFR7M	
PFR7N-D	
PFR7Q	
ZFR7F	

NGK	BRISK
BCP6ES	<b>DR15YS</b>
BCP6ET	
BCPR6ES	
BCPR6ET	
BKR6EK	
BKR6EKC	
BKR6EKE	
BKR6EKUB	
BKR6EP	
BKR6ES	
BKR6EY	
BKR6EYA	
BKUR6ET	
PFR6B	
ZFR6F	

NGK	BRISK
BCP5E	<b>DR17YS</b>
BCP5ES	
BCP5ET	
BCPR5E	
BCPR5ES	
BCPR5ET	
BK5E	
BK5ES	
BKR5E	
BKR5EK	
BKR5EKC	
BKR5EKU	
BKR5E-N	
BKR5EP	
BKR5ES	
BKR5EY	
BKR5EZ	
BKUR5ET	
PFR5B	
ZFR5F	

BCPR7ES-11	<b>DR14YS-9</b>
BCPR7EY-11	
PFR7B-11	
ZFR7F-11	
ZFR7J-11	

BCP6E-11	<b>DR15YS-9</b>
BCP6ES-11	
BCPR6E-11	
BCPR6ES-11	
BK6E-11	
BKR6E-11	
BKR6EKC-11	
BKR6E-N-11	
BKR6EP-11	
BKR6ES-11	
BKR6EY-11	
BKR6EYA-11	
BKR6N-11	
BKUR6ET-10	
PFR6B-11	
PFR6C-11	
ZF6A-11	
ZFR6A-11	
ZFR6F-11	
ZFR6J-11	

BCPR5ES-11	<b>DR17YS-9</b>
BKR5EKB-11	
BKR5EP-11	
BKR5ES-11	
BKR5EY-11	
BKR5N-11	
PFR5B-11	
PFR5C-11	
ZFR5A-11	
ZFR5F-11	
ZFR5J-11	

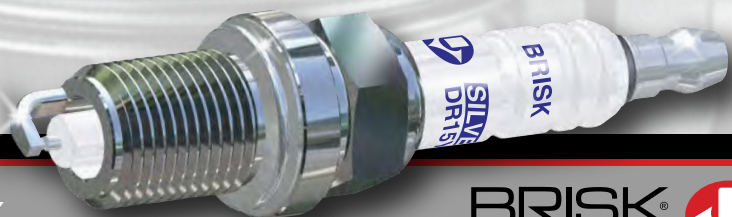

**Silver**

**BRISK**  
USA ENTERPRISES, LLC



# SPARK PLUG CROSS REFERENCE GUIDE

NGK	BRISK
BP7ES BP7ET BPR7E BPR7ES IGR7A PGR7A	LR14YS

NGK	BRISK
BP6E BP6ES BP6ESZ BP6ET BP6EY BPR6E BPR6EP-8 BPR6ES BPR6EY BUR6ET PGR6A	LR15YS

NGK	BRISK
BP5E BP5EA BP5EA-L BP5ES BP5ESZ BP5ET BPR5E BPR5EA BPR5EA-L BPR5ES BPR5EY	LR17YS

NGK	BRISK
ZGR6A	LR15YS

NGK	BRISK
BUR5ET PGR5A ZGR5A	LR17YS

NGK	BRISK
BPR6E-11 BPR6ES-11 BPR6EY-11 PGR6A-11 PGR6C-11	LR15YS-9

NGK	BRISK
BP5ET-10 BPR5E-11 BPR5EA-11 BPR5EP-11 BPR5ES-11 BUR5ET-10 BPR5EY-11 PGR5A-11 PGR5C-11	LR17YS-9

NGK	BRISK
B7HS B8HS BP7HS BPR7HS BR7HS BR8HS	NR14S

NGK	BRISK
B6HS BP6HS BP6HSA BPR6HS BR6HS	NR15S

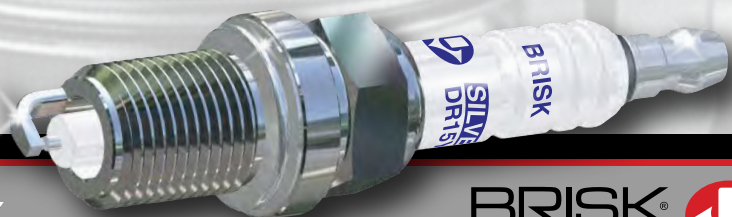

**Silver**

**BRISK**  
USA ENTERPRISES, LLC





## APPLICATION CHART

MANUFACTURER	COLDER			HOTTER		
<b>BRISK</b>	<b>8</b>	<b>10</b>	<b>12</b>	<b>14</b>	<b>15</b>	<b>17</b>
<b>NGK</b>	<b>10</b>	<b>9</b>	<b>8</b>	<b>7</b>	<b>6</b>	<b>5</b>
<b>DENSO</b>	<b>31</b>	<b>27</b>	<b>24</b>	<b>22</b>	<b>20</b>	<b>16</b>

For the 2008 - 2010 Ford 3 Valve engines with the new 12mm thread diameter plug we offer:

**Brisk Silver Racing Spark Plug XOR14YS - stock and modified**

**Brisk Silver Racing Spark Plug XOR12YS - heavy modified**

*- Stock Ignition Best*

For the 2005 - 2008 Ford 4.0L, 5.0L, 5.8L 3 Valve engines with High Thread style plug we offer:

**Brisk Silver Racing and Performance Spark Plug**

**Brisk Silver Racing Spark Plug 3VR17YS - stock and light modified**

**Brisk Silver Racing Spark Plug 3VR14S - light modified and washed**

**Brisk Silver Racing Spark Plug 3VR12S - high boost and/or heavy nitrous**

**Brisk Silver Racing Spark Plug 3VR10S - extreme power applications -**

**Stock Ignition Best** *JPC performance Best - Mustang 1000iRWHR (high boost and nitrous)*

*-all the Brisk performance and racing spark plugs are reserved out of the stock with positive out-back ground electrode*

For the 4.0L, 5.0L, 5V and 4V, SVT Mustang Coupe, Shelby, Ford GT...

**Brisk Silver Racing and Performance Spark Plug**

**Brisk Silver Racing Spark Plug OR14YS - jet to about 550 HP (non-resistor plug - do not use with Q-cold connectors between coil/plug)**

**Brisk Silver Racing Spark Plug OR14S - jet to about 500 HP**

**Brisk Silver Racing Spark Plug OR12S - jet to about 350 HP**

**Brisk Silver Racing Spark Plug OR08S - jet to about 3,500 RWHF (non-resistor plug - do not use with Q-cold connectors between coil/plug)**

**Brisk Silver Racing**

**Gasket types:**

**OR08S (non projected tip)**

**OR08S (non projected tip, resistor)**

**OR10S (non projected tip)**

**OR10S (non projected tip, resistor)**

**OR12S (non projected tip)**

**OR12S (non projected tip, resistor)**

**OR14S (non projected tip, resistor)**

**OR12YS (projected tip)**

**OR12YS (projected tip, resistor)**

**OR14YS (projected tip, resistor)**

**Replaces:**

**NGK R 5671A-10**

**NGK R 5671A-8**

**NGK R 5671A-6**

**NGK R 5671A-7**

**NGK R 5672A-8**

*Notes:*



BRISK

BRISK

# IRIDIUM

*Performance*

77  
IR  
39  
CU  
29  
CU



IRIDIUM IS 6X HARDER & 8X STRONGER THAN PLATINUM  
LONG LASTING OEM PERFORMANCE REPLACEMENT  
DUAL COPPER CORE ELECTRODES FOR MORE ENERGY  
CUT BACK GROUND STRAP FOR MAXIMUM SPARK EXPOSURE  
LOW IGNITION VOLTAGE REQUIREMENTS, MAKES FOR EASIER STARTS

# MULTI

*spark*

81  
TI  
47  
AG  
29  
CU



MULTI-SPARK PLUG INCREASES ENGINE POWER – 3 X'S THE SPARK  
PATENTED AUXILIARY ELECTRODE DESIGN  
MORE HORSE POWER, TORQUE, FASTER ACCELERATION & RESPONSE  
MAXIMUM SPARK EXPOSURE, BETTER USE OF AVAILABLE ENERGY  
NO GAPPING OR INDEXING

# IRIDIUM

*Racing*

77  
IR  
29  
CU



IRIDIUM IS 6X HARDER & 8X STRONGER THAN PLATINUM  
SHELL DIRECTS FLAME FRONT TO MAXIMIZE POWER  
PROTECTS INSULATOR FROM THERMAL SHOCKS  
LOW IGNITION VOLTAGE REQUIREMENTS, MAKES FOR EASIER STARTS  
OPTIMIZED CENTER ELECTRODE DIAMETER FOR HARD TO IGNITE FUELS

# BRISK



# USA

# TURBO

*Racing*

47  
AG



REDUCES NUMBER OF IMPERFECTLY IGNITED CYCLES  
EXTREMELY HIGH DURABILITY AND RELIABILITY  
HIGH RESISTANCE AGAINST THERMAL SHOCK AND VIBRATION  
PROGRESSIVELY TAPERED GROUND ELECTRODE INTEGRATION  
SUPERIOR HEAT DISPLACEMENT

# PREMIUM

*legs*

47  
AG



HIGH-POTENTIAL SEMI-SURFACE DISCHARGE = MORE POWER  
DISCHARGE AT RICHEST POINT OF A/F MIXTURE IN 360\* PERIMETER  
PATENTED FIRING TIP DESIGN, NO INDEXING OR GAPPING REQUIRED  
SILVER CENTER ELECTRODE  
BEST THERMAL HEAT & ELECTRICAL CONDUCTOR

# SILVER

*Racing*

47  
AG



SILVER IS THE BEST CONDUCTOR OF THERMAL HEAT & ELECTRICITY  
SUPERIOR IGNITION ABILITY, INCREASES ENGINE POWER  
TURBO / SUPERCHARGED / NITROUS ENGINES  
LOWER REQUIRED SUPPLIED IGNITION VOLTAGE  
RACE ENGINES & ENGINES WITH HARD TO IGNITE FUELS



**1935** BRITA COMPANY ENGAGED IN PRODUCTION OF SPARK PLUGS  
WAS FOUNDED IN TABOR, CZECH REPUBLIC

FOUNDATION OF AN INDEPENDENT NATIONAL ENTERPRISE  
FOCUSED ON PRODUCTION OF AUTOMOTIVE SPARK PLUGS **1955**

**1975** LAUNCHING 3RD-GENERATION SPARK PLUGS. PRODUCTION  
OF TECHNICAL AND ELECTROTECHNICAL CERAMICS

BRISK RECEIVES ISO 9001 CERTIFICATION AND  
EXTENDS PRODUCT RANGE BY EMISSION TESTERS **1994**

**1999** BRISK IS CLASSIFIED AMONG THE BEST SPARK PLUG  
AND SPEED SENSOR SUPPLIERS OF VW CONCERN

COMMENCEMENT OF PRODUCTION OF SECOND-GENERATION  
BRISK PREMIUM LGS SPARK-PLUGS **2002**

**2004** BRISK BEGINS SUPPLY OF BRISK SILVER AND BRISK PREMIUM  
SPARK PLUGS FOR PRIMARY PRODUCTION OF TM RACING.

**BRISK CELEBRATES 2015**  
**80** YEARS OF BUSINESS AND THE MAJOR MILESTONE OF  
**1** BILLION SPARK PLUGS  
MANUFACTURED

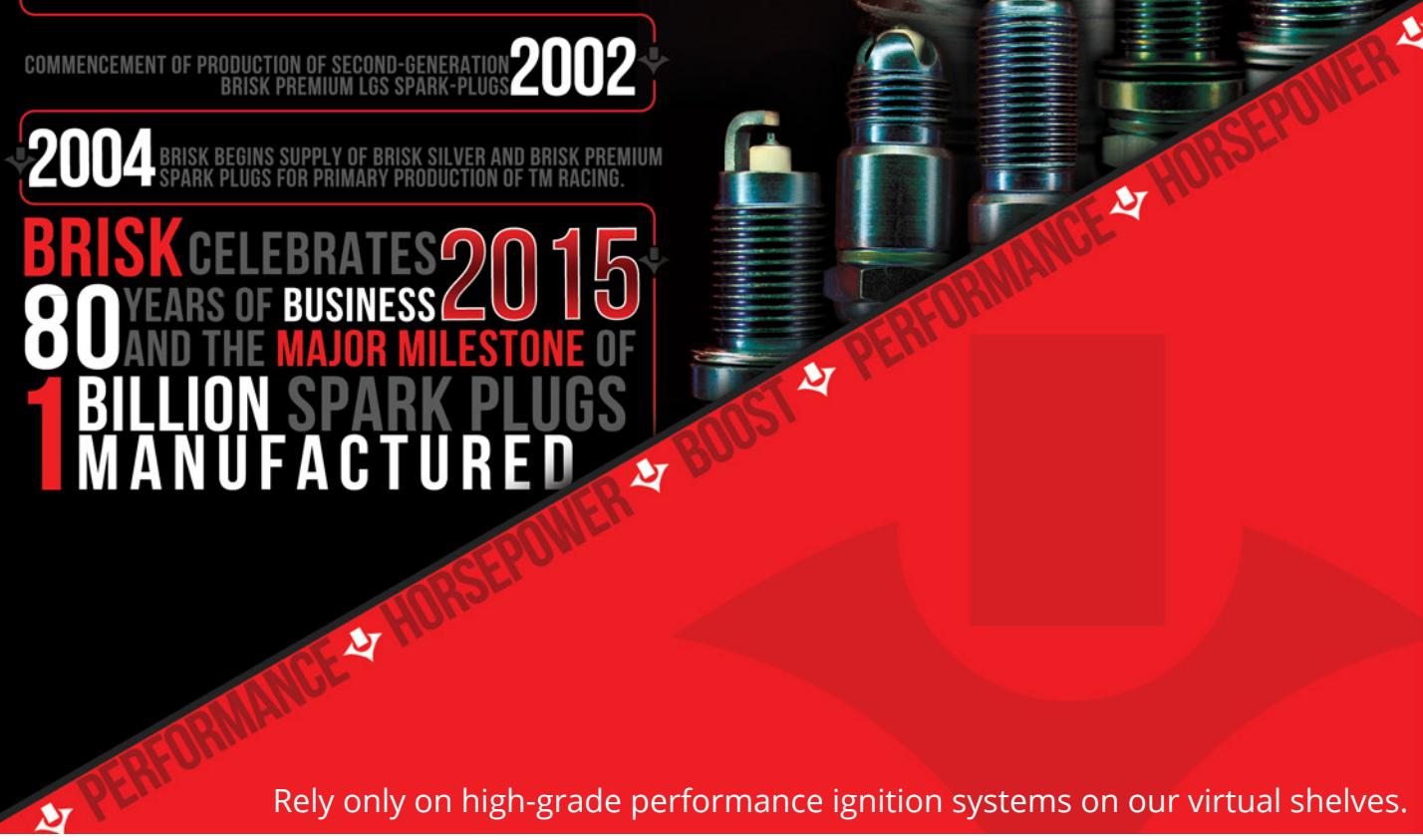

Rely only on high-grade performance ignition systems on our virtual shelves.