

Installation for Audi A3 Sedan PN-140682



Thank you for purchasing a Borla [Performance Exhaust System](#).

Borla Performance Exhaust System (PN-140682) is designed for the Audi A3 Sedan equipped with a 2.0T engine, automatic transmission.

Borla Performance Industries recommends that an exhaust shop or professional after market parts installer perform the installation of this system. However, if you decide to perform the installation on your own it is recommended that two people are used. This installation should not be performed by one person due to the risk of injury. Ensure the installers use all under car safety precautions including eye protection.

Please take time to read and understand the following...

By installing your Borla Performance Exhaust System, you indicate that you have read this document and you agree with the terms stated below.

It is the responsibility of the purchaser to follow all installation instruction guidelines and safety procedures supplied with your Borla Performance Exhaust System.

Borla Performance Industries assumes no responsibility for damages occurring from misuse, abuse, improper installation, improper operation, lack of responsible care, or all previously stated reasons resulting from incompatibility with other manufacturer's products and/or systems.

Included with your Borla Performance Exhaust System is a warranty card. Please read it carefully before you begin any work on your vehicle. If you should have any questions regarding our warranty policy, installation, or any other matter pertaining to your new Borla Performance Exhaust System, please give us a call at the number provided on the warranty card.

Minimum Required Tool List:

TOOLS:

- 1 3/8" Drive Ratchet
- 2 3/8" Drive Extension 3"
- 3 15mm Socket
- 4 13mm Socket
- 5 Pry Bar

SHOP SUPPLIES:

- 1 Spray Lubricant

Borla Performance - Bill of Materials

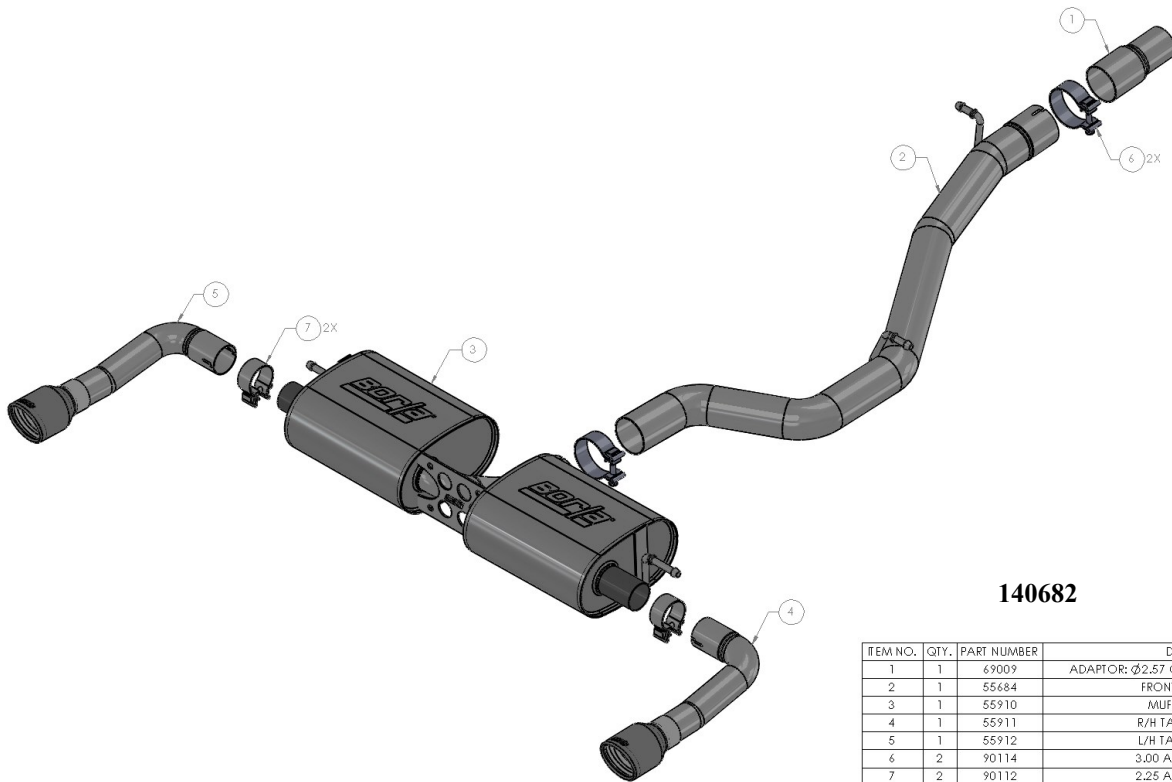

140682

ITEM NO.	QTY.	PART NUMBER	DESCRIPTION
1	1	69009	ADAPTOR: $\varnothing 2.57$ O.D. X 6.63" LG. X $\varnothing 3.00$ O.D.
2	1	55684	FRONT PIPE ASSEMBLY
3	1	55910	MUFFLER ASSEMBLY
4	1	55911	R/H TAIL PIPE ASSEMBLY
5	1	55912	L/H TAIL PIPE ASSEMBLY
6	2	90114	3.00 ACCUSEAL CLAMP
7	2	90112	2.25 ACCUSEAL CLAMP

Caution!!! *Never work on a hot exhaust system. Serious injury in the form of burns can result if the vehicle has been in use and the exhaust system is hot, allow vehicle to cool for at least 1 hour. Always wear eye protection when working under any vehicle.*

Note: *It is our recommendation that you use a hoist or hydraulic lift to facilitate the installation of your new Borla Performance Exhaust System.*

Taking all under car safety precautions, lift the vehicle using a hoist or hydraulic lift. Once this has been done, you may begin the removal of your old exhaust system from your vehicle.

Note: *Before removing the original exhaust system from your vehicle, please compare the parts you have received with the bill of materials provided on the previous page to assure that you have all the parts necessary for the installation of your new Borla Performance Exhaust System.*

Note: *With a used vehicle, we suggest a penetrating spray lubricant to be applied liberally to all exhaust fasteners and allowing a significant period of time for the chemical to lubricate the threads before attempting to disassemble.*

Original Exhaust System Removal

1. Loosen band-clamp nuts using a 13mm socket and slide clamp off exhaust tubing. Keep clamp on vehicle for installation. (See Fig. 1)
2. Support muffler assembly using a muffler stand. Carefully slide front and rear hangers of muffler assembly from rubber isolators. Remove exhaust system from vehicle. (See Figs. 2, 3 & 4)
3. Exhaust system removed. (See Fig. 5)

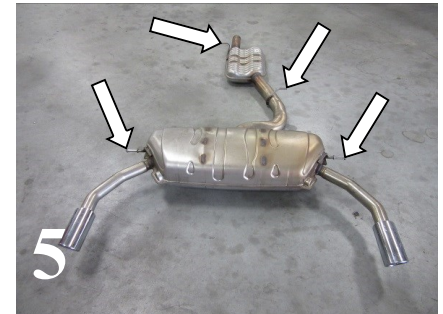
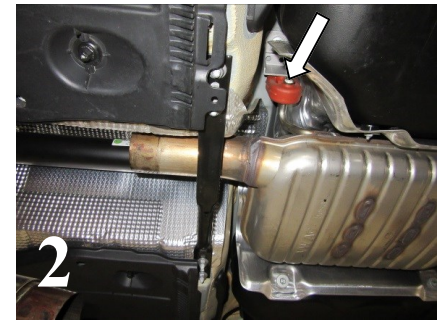
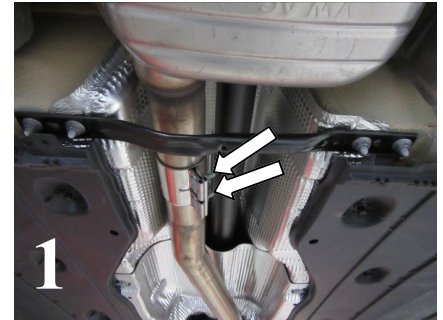

WARNING: *Use extreme caution during installation. Torque all fasteners according to manufacturer's torque values and tightening sequence. **DO NOT** use air impact tools to tighten fasteners on Borla Performance Exhaust Systems. Use of such tools may result in bent flanges or gasket contact areas leading to exhaust leaks.*

NOTE: *When you first start your vehicle after the installation of your new Borla Performance Exhaust System, there may be some smoke and fumes coming from the system. This is a protective oil based coating used in the manufacturing of mandrel bent performance exhaust tubing. This is not a problem and will disappear within a very short period of time after the exhaust has reached normal operating temperatures.*

Borla Performance Exhaust System Installation

1. Using the original band clamp, install **3" Adaptor** and hand-tighten clamp nuts. (See Fig. 6)
2. Place a 3.00" clamp over the expanded end of **Front Pipe Assembly** and insert inlet into **3" Adaptor**. Carefully insert hangers into rubber isolators (See Figs. 7 & 8) Do not tighten clamp nut.
3. Place a **2.25" clamp** over the **Muffler Assembly** and insert inlet into **Front Pipe Assembly** outlet. Carefully insert hangers into rubber isolators. Do not tighten clamp nut. (See Fig. 9)
4. Place a clamp on the expanded end of the **R/H Tail Pipe Assembly** and insert to outlet of right-side **Muffler Assembly** outlet. Do not tighten clamp nut.
5. Repeat step 4 for **L/H Tail Pipe Assembly**. Do not tighten clamp nut. (See Fig. 9)
6. Starting at front and working to rear of vehicle, check your exhaust system for proper clearance under the vehicle and also for tip alignment. Once position has been determined to be correct, tighten the clamp bolts, 32-35 ft. lbs. Then tighten the flange bolts, 32-35 ft.lbs. (See Fig. 10)
7. Before starting your vehicle, make sure to check all wires, hoses, brake lines, body parts and tires for safe clearance from the exhaust system.
8. Start vehicle and check for any leaks. If any leaks are found, determine cause (such as loose or incorrectly positioned clamp) and repair as necessary.

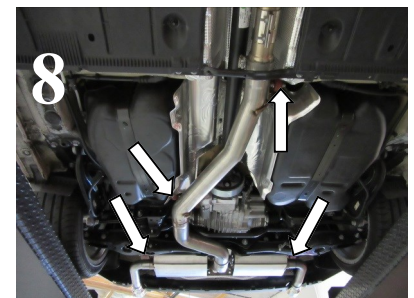
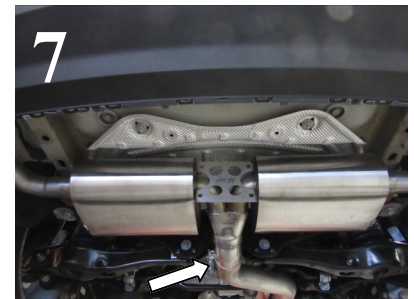
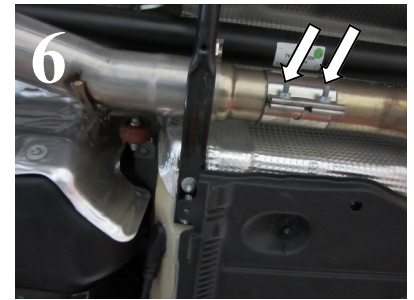

WARNING: Use extreme caution during installation. Torque all fasteners according to manufacturer's torque values and tightening sequence. **DO NOT** use air impact tools to tighten fasteners on Borla Performance Exhaust Systems. Use of such tools may result in bent flanges or gasket contact areas leading to exhaust leaks.

NOTE: When you first start your vehicle after the installation of your new Borla Performance Exhaust System, there may be some smoke and fumes coming from the system. This is a protective oil based coating used in the manufacturing of mandrel bent performance exhaust tubing. This is not a problem and will disappear within a very short period of time after the exhaust has reached normal operating temperatures.