

Installation Guide for Nissan Titan PNs 140796, 140796BC



******* Please compare the parts in the box with the bill of materials provided *****
to assure that you have all the parts necessary for this installation.**

These instructions have been written to help you with the installation of your Borla Performance exhaust system. Please read this document completely before beginning the installation of your system.

Thank you for purchasing a Borla Performance Cat-Back™ exhaust system.

These Borla Performance Cat-Back™ exhaust systems (PNs 140796, 140796BC) are designed for the Nissan Titan, equipped with a 5.6L V8 engine and 2WD or 4WD automatic transmission.

Borla Performance Industries recommends that an exhaust shop or professional after market parts installer, who has all the necessary equipment, tools and experienced personnel needed for proper installation, should perform the installation of this system. However, if you decide to perform the installation, we recommend someone should help you. Ensure the installer uses all under car safety precautions including eye protection.

Please take time to read and understand the following...

By installing your Borla Performance exhaust system, you indicate that you have read this document and you agree with the terms stated below.

It is the responsibility of the purchaser to follow all installation instruction guidelines and safety procedures supplied with your Borla Performance Exhaust System.

Borla Performance Industries assumes no responsibility for damages occurring from misuse, abuse, improper installation, improper operation, lack of responsible care, or all previously stated reasons resulting from incompatibility with other manufacturer's products and/or systems.

Included with your Borla Performance exhaust system is a warranty card. Please read it carefully before you begin any work on your vehicle. If you should have any questions regarding our warranty policy, installation, or any other matter pertaining to your new Borla Performance exhaust system, please give us a call at the number provided on the warranty card.

Minimum Required Tool List:

TOOLS:

1. 3/8" drive ratchet
2. 3/8" drive extension 3"
3. 3/8" drive extension 6"
4. 15mm deep well socket
5. 13mm socket
6. 10mm socket
7. Pry bar

SHOP SUPPLIES:

1. Spray lubricant

Borla Performance - Bill of Materials

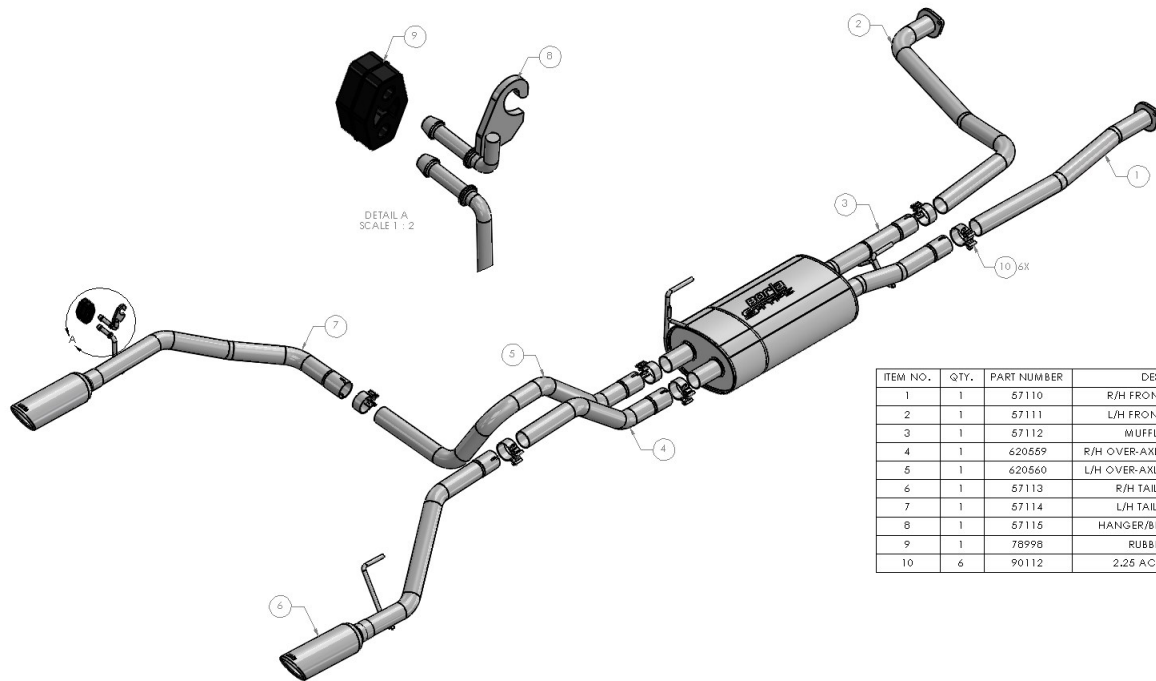

ITEM NO.	QTY.	PART NUMBER	DESCRIPTION
1	1	57110	R/H FRONT PIPE ASSEMBLY
2	1	57111	L/H FRONT PIPE ASSEMBLY
3	1	57112	MUFFLER ASSEMBLY
4	1	620559	R/H OVER-AXLE PIPE:Ø2.25 X 31.25"
5	1	620560	L/H OVER-AXLE PIPE:Ø2.25 X 52.35"
6	1	57113	R/H TAILPIPE ASSEMBLY
7	1	57114	L/H TAILPIPE ASSEMBLY
8	1	57115	HANGER/BRACKET ASSEMBLY
9	1	78998	RUBBER ISOLATOR
10	6	90112	2.25 ACCUSEAL CLAMP

Caution!!! *Never work on a hot exhaust system. Serious injury in the form of burns can result if the vehicle has been in use and the exhaust system is hot, allow vehicle to cool for at least 1 hour. Always wear eye protection when working under any vehicle.*

Note: *It is our recommendation that you use a hoist or hydraulic lift to facilitate the installation of your new Borla Performance Exhaust System.*

Taking all under car safety precautions, lift the vehicle using a hoist or hydraulic lift. Once this has been done, you may begin the removal of your old exhaust system from your vehicle.

Note: *Before removing the original exhaust system from your vehicle, please compare the parts you have received with the bill of materials provided on the previous page to assure that you have all the parts necessary for the installation of your new Borla Performance Exhaust System.*

Note: *With a used vehicle, we suggest a penetrating spray lubricant to be applied liberally to all exhaust fasteners and allowing a significant period of time for the chemical to lubricate the threads before attempting to disassemble.*

Original Exhaust System Removal

1. Lubricate all hangers, rubber isolators, bolts and nuts.
2. Remove the bolts securing the tailpipe hanger bracket to the vehicle (fig. 1). Keep the hardware for later reinstallation.
3. Loosen the clamp connecting the tailpipe to the muffler assembly (fig. 2).
4. Carefully remove the tailpipe from the vehicle (fig. 3).
5. Loosen the nuts securing the L/H muffler assembly flange to the vehicle (fig. 4).
6. Loosen the nuts securing the R/H muffler assembly flange to the vehicle (fig. 5). Move the ground wire to the side; it will need to be reinstalled with your Borla system.

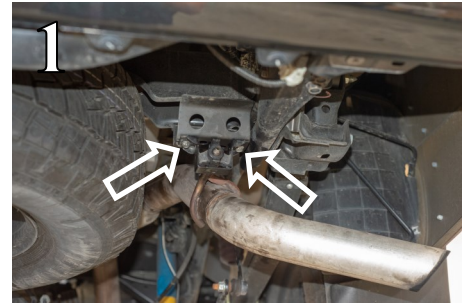

Caution!!! *Never work on a hot exhaust system. Serious injury in the form of burns can result if the vehicle has been in use and the exhaust system is hot, allow vehicle to cool for at least 1 hour. Always wear eye protection when working under any vehicle.*

Note: *It is our recommendation that you use a hoist or hydraulic lift to facilitate the installation of your new Borla Performance Exhaust System.*

Taking all under car safety precautions, lift the vehicle using a hoist or hydraulic lift. Once this has been done, you may begin the removal of your old exhaust system from your vehicle.

Note: *Before removing the original exhaust system from your vehicle, please compare the parts you have received with the bill of materials provided on the previous page to assure that you have all the parts necessary for the installation of your new Borla Performance Exhaust System.*

Note: *With a used vehicle, we suggest a penetrating spray lubricant to be applied liberally to all exhaust fasteners and allowing a significant period of time for the chemical to lubricate the threads before attempting to disassemble.*

Original Exhaust System Removal Cont'd

7. Loosen the bolts securing the muffler assembly hanger bracket to the vehicle (fig. 6).
8. Using a muffler stand or an additional person, remove the muffler assembly from the vehicle (fig. 7).
9. Remove the hanger bracket from the original muffler assembly (fig. 8). Also remove the tailpipe hanger bracket from the original system if not already done.
10. Original exhaust system removed.

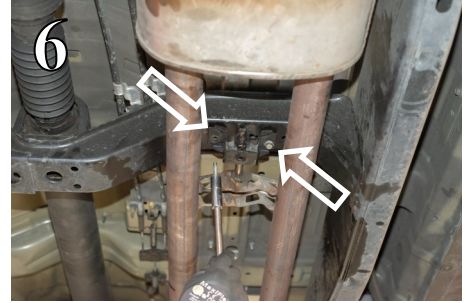

Borla Performance Cat-Back™ Exhaust System Installation

1. Orient the components on shop floor according to the Borla bill of materials drawing on page 2.
2. Connect the **L/H front pipe assembly** to the vehicle and tighten the nuts on the flange to secure it (figs. 9, 10).
3. Repeat step 2 for the **R/H front pipe assembly** (fig. 11), securing the ground contact to the flange with one of the nuts (figs. 12, 13).



WARNING: Use extreme caution during installation. Torque all fasteners according to manufacturer's torque values and tightening sequence. **DO NOT** use air impact tools to tighten fasteners on Borla Performance Exhaust Systems. Use of such tools may result in bent flanges or gasket contact areas leading to exhaust leaks.

NOTE: When you first start your vehicle after the installation of your new Borla Performance Exhaust System, there may be some smoke and fumes coming from the system. This is a protective oil based coating used in the manufacturing of mandrel bent performance exhaust tubing. This is not a problem and will disappear within a very short period of time after the exhaust has reached normal operating temperatures.

Borla Performance Cat-Back™ Exhaust System Installation Cont'd

- Place the original muffler assembly hanger bracket on the muffler assembly.
- Slide two clamps over the inlets of the muffler assembly and raise it to the vehicle. Insert the outlets of the front pipe assemblies into the muffler assembly (fig. 14).
- Tighten the bolts on the muffler assembly hanger bracket (fig. 15).
- Slide a clamp over the inlet of the R/H over-axle pipe and connect it to the R/H outlet of the muffler assembly (fig. 16).
- Repeat step 7 for the L/H over-axle pipe (fig. 17).
- Reinstall the original tailpipe assembly hanger bracket (fig. 18).
- Slide a clamp over the inlet of the **R/H tailpipe** and connect it to the R/H over-axle pipe, inserting its hanger into the original tailpipe assembly hanger bracket (fig. 18).

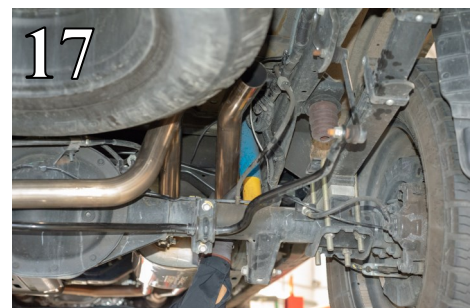
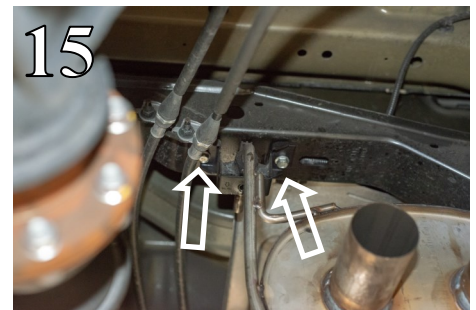

WARNING: Use extreme caution during installation. Torque all fasteners according to manufacturer's torque values and tightening sequence. **DO NOT** use air impact tools to tighten fasteners on Borla Performance Exhaust Systems. Use of such tools may result in bent flanges or gasket contact areas leading to exhaust leaks.

NOTE: When you first start your vehicle after the installation of your new Borla Performance Exhaust System, there may be some smoke and fumes coming from the system. This is a protective oil based coating used in the manufacturing of mandrel bent performance exhaust tubing. This is not a problem and will disappear within a very short period of time after the exhaust has reached normal operating temperatures.

Borla Performance Cat-Back™ Exhaust System Installation Cont'd

11. Remove the nut (only) and install the **hanger/bracket assembly** on the bolt, securing it with the stock nut (fig. 19). **DO NOT REMOVE THE BOLT FROM THE SHACKLE.**
12. Place the rubber isolator provided in the kit on the hanger/bracket assembly (fig. 19).
13. Slide a clamp over the inlet of the L/H tailpipe and connect it to the L/H over-axle pipe (fig. 20).
14. Check your exhaust system for proper clearance under the vehicle and also for tip alignment. Starting at front flanges and moving to rear of vehicle, tighten flange hardware bolts. Orient position of bolt (on supplied clamps) between (not over) pipe notches and tighten to 35 ft. lbs. torque.
15. Align tips and tighten hardware. Loosen clamps to rotate or slide pipe for better alignment (fig. 21).
16. Before starting your vehicle, make sure to check all wires, hoses, brake lines, body parts and tires for safe clearance from the exhaust system.
17. Start the vehicle and check for any leaks. If any leaks are found, determine cause (such as loose or incorrectly positioned clamp) and repair as necessary.

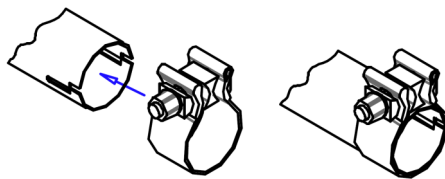
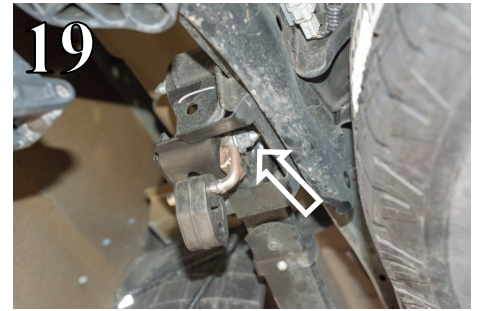

WARNING: Use extreme caution during installation. Torque all fasteners according to manufacturer's torque values and tightening sequence. **DO NOT** use air impact tools to tighten fasteners on Borla Performance Exhaust Systems. Use of such tools may result in bent flanges or gasket contact areas leading to exhaust leaks.

NOTE: When you first start your vehicle after the installation of your new Borla Performance Exhaust System, there may be some smoke and fumes coming from the system. This is a protective oil based coating used in the manufacturing of mandrel bent performance exhaust tubing. This is not a problem and will disappear within a very short period of time after the exhaust has reached normal operating temperatures.