

Installation Guide for Audi A4 Quattro 140759, 140759BC, 140759SB, 140761, 140761BC, 140761SB



******* Please compare the parts in the box with the bill of materials provided *****
to assure that you have all the parts necessary for this installation.**

These instructions have been written to help you with the installation of your Borla Performance exhaust system. Please read this document completely before beginning the installation of your system.

Thank you for purchasing a Borla Performance exhaust system.

Borla Performance Cat-Back™ exhaust system PNs 140759, 140761BC, and 140761SB are designed for the Audi A4 Quattro Sedan equipped with a 2.0L turbocharged I4 engine, automatic or manual transmission.

Borla Performance Cat-Back™ exhaust system PNs 140761, 140761BC, and 140761SB are designed for the Audi A4 Quattro Sedan equipped with a 2.0L turbocharged I4 engine, automatic or manual transmission.

Borla Performance Industries recommends that an exhaust shop or professional after market parts installer, who has all the necessary equipment, tools and experienced personnel needed for proper installation, should perform the installation of this system. However, if you decide to perform the installation, we recommend someone should help you. Ensure the installer uses all under car safety precautions including eye protection.

Please take time to read and understand the following...

By installing your Borla Performance exhaust system, you indicate that you have read this document and you agree with the terms stated below.

It is the responsibility of the purchaser to follow all installation instruction guidelines and safety procedures supplied with your Borla Performance exhaust system.

Borla Performance Industries assumes no responsibility for damages occurring from misuse, abuse, improper installation, improper operation, lack of responsible care, or all previously stated reasons resulting from incompatibility with other manufacturer's products and/or systems.

Included with your Borla Performance exhaust system is a warranty card. Please read it carefully before you begin any work on your vehicle. If you should have any questions regarding our warranty policy, installation, or any other matter pertaining to your new Borla Performance Exhaust System, please give us a call at the number provided on the warranty card.

Minimum Required Tool List:

TOOLS:

1. 3/8" drive ratchet
2. 3/8" drive extension 6"
3. 15mm socket
4. 13mm socket
5. 15mm wrench
6. T-15 Torx screwdriver
7. Flathead screwdriver
8. Pry bar

SHOP SUPPLIES:

1. Spray lubricant

Borla Performance - Bill of Materials

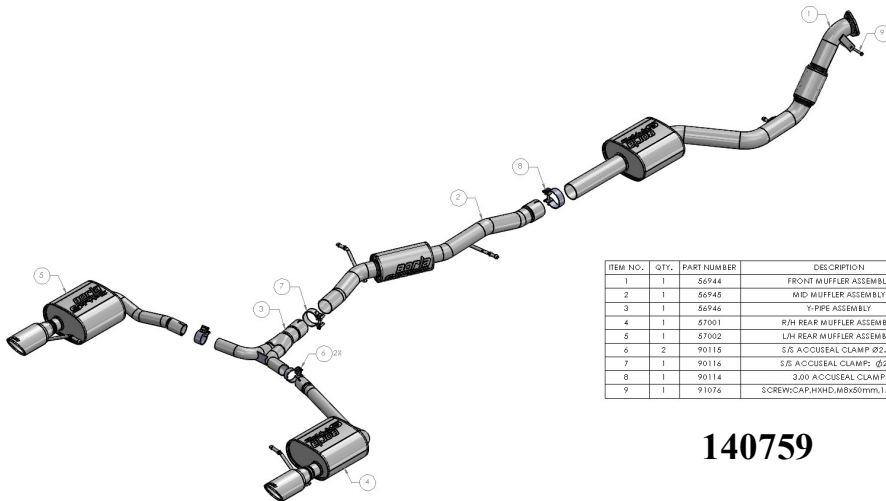

ITEM NO.	QTY.	PART NUMBER	DESCRIPTION
1	1	56944	FRONT MUFFLER ASSEMBLY
2	1	56945	MID MUFFLER ASSEMBLY
3	1	56946	Y-PIPE ASSEMBLY
4	1	57001	R/H REAR MUFFLER ASSEMBLY
5	1	57002	L/H REAR MUFFLER ASSEMBLY
6	2	90115	S/S ACCUSEAL CLAMP Ø2.00
7	1	90116	S/S ACCUSEAL CLAMP: Ø2.75
8	1	90114	3/8" ACCUSEAL CLAMP
9	1	91076	SCREW:CAP,HHHD,MSx50mm,1.25pitch

140759

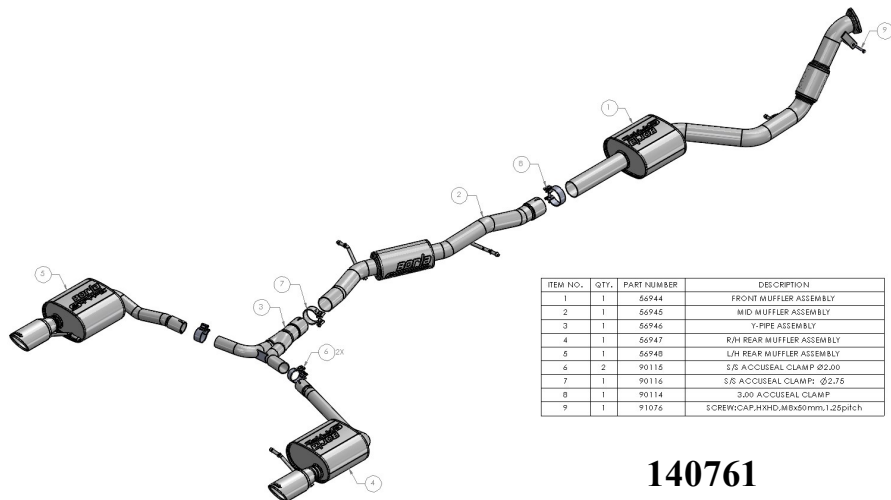

ITEM NO.	QTY.	PART NUMBER	DESCRIPTION
1	1	56944	FRONT MUFFLER ASSEMBLY
2	1	56945	MID MUFFLER ASSEMBLY
3	1	56946	Y-PIPE ASSEMBLY
4	1	56947	R/H REAR MUFFLER ASSEMBLY
5	1	56948	L/H REAR MUFFLER ASSEMBLY
6	2	90115	S/S ACCUSEAL CLAMP Ø2.00
7	1	90116	S/S ACCUSEAL CLAMP: Ø2.75
8	1	90114	3/8" ACCUSEAL CLAMP
9	1	91076	SCREW:CAP,HHHD,MSx50mm,1.25pitch

140761

Caution!!! *Never work on a hot exhaust system. Serious injury in the form of burns can result if the vehicle has been in use and the exhaust system is hot, allow vehicle to cool for at least 1 hour. Always wear eye protection when working under any vehicle.*

Note: *It is our recommendation that you use a hoist or hydraulic lift to facilitate the installation of your new Borla Performance Exhaust System.*

Taking all under car safety precautions, lift the vehicle using a hoist or hydraulic lift. Once this has been done, you may begin the removal of your old exhaust system from your vehicle.

Note: *Before removing the original exhaust system from your vehicle, please compare the parts you have received with the bill of materials provided on the previous page to assure that you have all the parts necessary for the installation of your new Borla Performance Exhaust System.*

Note: *With a used vehicle, we suggest a penetrating spray lubricant to be applied liberally to all exhaust fasteners and allowing a significant period of time for the chemical to lubricate the threads before attempting to disassemble.*

Original Exhaust System Removal

1. Lubricate all hangers, rubber isolators, bolts and nuts.
2. Remove L/H and R/H muffler assembly hangers from rubber isolators (figs. 1 & 2).
3. Remove four (4) fasteners on crossmember assembly and remove from vehicle. Keep components for later reinstallation (fig. 3). Note: A4 Avant/Allroad models will have additional bracing not pictured in this document.
4. Remove front muffler hanger from rubber isolator bracket. Keep hardware for later reinstallation (fig. 4).
5. Loosen two (2) bolts on front muffler assembly clamp. Keep hardware for later reinstallation (fig. 5).

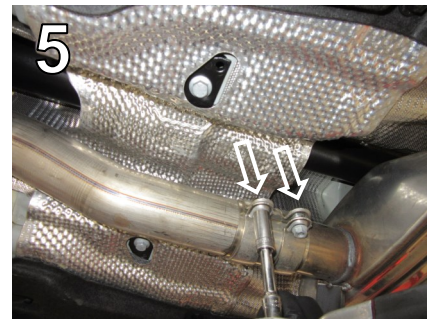
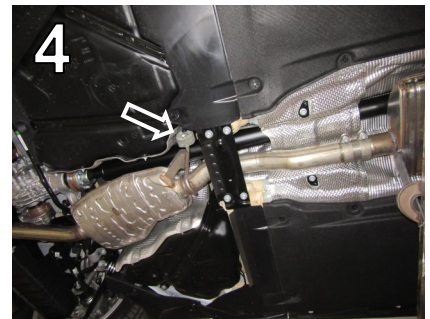
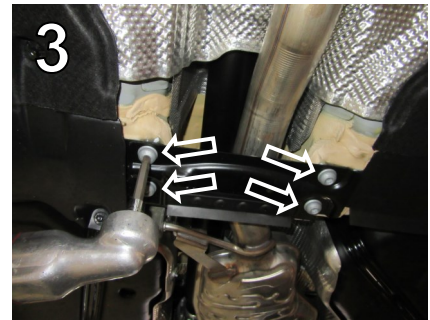

Original Exhaust System Removal Cont'd

6. Original mid-pipes and rear section removed (fig. 6).
7. Loosen bolts on front muffler assembly forward rubber isolator bracket. Keep hardware for later reinstallation (fig. 7).
8. Loosen three (3) flange bolts and one (1) bracket bolt on original front muffler assembly (fig. 8).
9. Remove front muffler hanger from rubber isolator.
10. Using a muffler stand or an additional person, carefully remove the front muffler assembly from the vehicle (fig. 9).
11. Original exhaust system removed.
12. Remove rubber isolator and bracket from original front muffler assembly hanger (fig. 10).

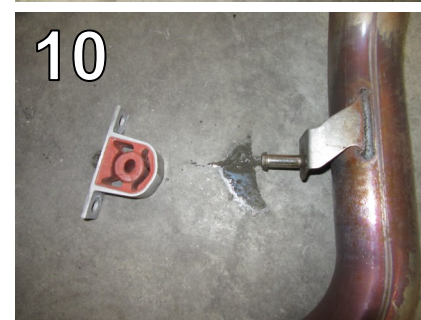
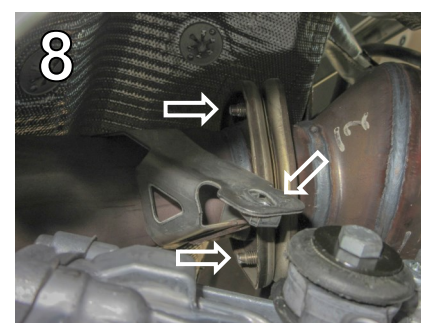
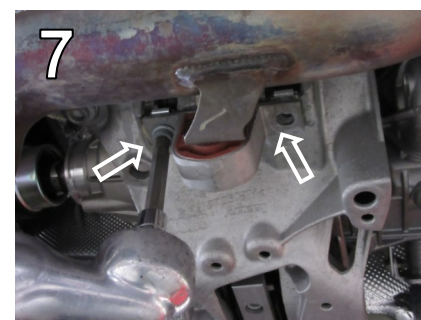

Borla Performance Cat-Back™ Exhaust System Installation

1. Orient components on floor referencing the page-2 drawing.
2. Place original rubber isolator bracket on forward hanger of Borla front muffler assembly (fig. 11).
3. Carefully raise the Borla front muffler assembly to vehicle (fig. 12).
4. Using a muffler stand or an additional person to hold the , insert fasteners of original front muffler assembly rubber isolator bracket to vehicle. (fig. 13).
5. Tighten bolt on Borla front muffler assembly mounting bracket to transmission (fig. 14).
6. Tighten three (3) flange bolts connecting Borla front muffler assembly to original exhaust catalytic converter (figs. 15 & 16).

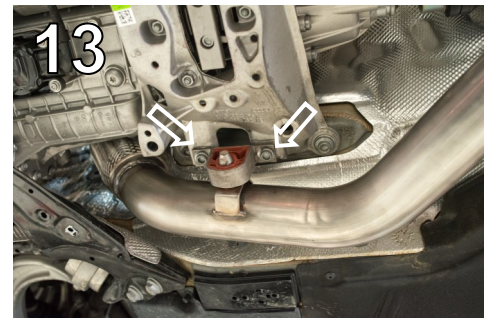

WARNING: Use extreme caution during installation. Torque all fasteners according to manufacturer's torque values and tightening sequence. **DO NOT** use air impact tools to tighten fasteners on Borla Performance Exhaust Systems. Use of such tools may result in bent flanges or gasket contact areas leading to exhaust leaks.

NOTE: When you first start your vehicle after the installation of your new Borla Performance Exhaust System, there may be some smoke and fumes coming from the system. This is a protective oil based coating used in the manufacturing of mandrel bent performance exhaust tubing. This is not a problem and will disappear within a very short period of time after the exhaust has reached normal operating temperatures.

Borla Performance Cat-Back™ Exhaust System Installation Cont'd

7. Place a clamp over the inlet of the Borla Y-pipe assembly.
8. Place the inlet of the Borla Y-pipe assembly over the outlet of the Borla middle muffler assembly. Do not tighten the clamp (fig. 17).
9. Insert the Borla middle muffler assembly forward hanger into its original rubber isolator w/ mounting bracket (fig. 18).
10. Slide a clamp over the outlet of the Borla front muffler assembly (fig. 19).
11. Slide Borla middle muffler assembly inlet over Borla front muffler assembly outlet. Do not tighten the clamp (fig. 20).

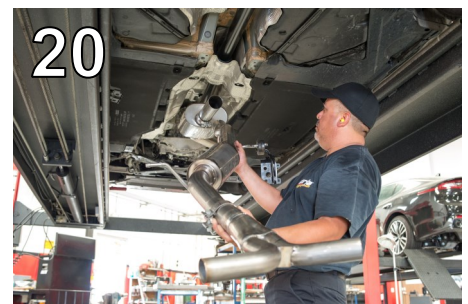
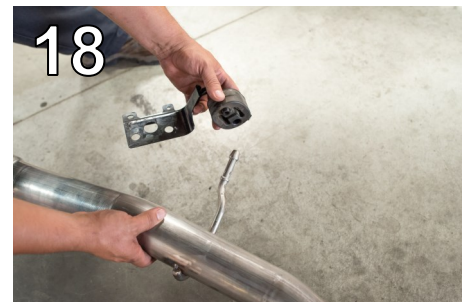
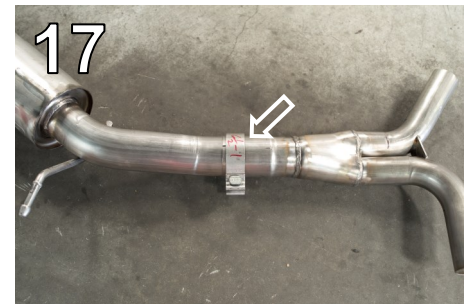

WARNING: Use extreme caution during installation. Torque all fasteners according to manufacturer's torque values and tightening sequence. **DO NOT** use air impact tools to tighten fasteners on Borla Performance Exhaust Systems. Use of such tools may result in bent flanges or gasket contact areas leading to exhaust leaks.

NOTE: When you first start your vehicle after the installation of your new Borla Performance Exhaust System, there may be some smoke and fumes coming from the system. This is a protective oil based coating used in the manufacturing of mandrel bent performance exhaust tubing. This is not a problem and will disappear within a very short period of time after the exhaust has reached normal operating temperatures.

Borla Performance Cat-Back™ Exhaust System Installation Cont'd

11. Reinstall crossmember (fig. 21).
12. Slide provided clamps over the outlets of the Borla middle muffler assembly (fig. 22).
13. Slide L/H and R/H Borla rear muffler assembly inlets over Borla middle muffler assembly outlets (fig. 23).
14. Insert L/H and R/H Borla rear muffler assembly hangers into rubber isolators (fig. 24).
15. Check your exhaust system for proper clearance under the vehicle and also for tip alignment. Starting at front flanges and moving to rear of vehicle, tighten flange hardware bolts. Orient position of bolt (on supplied clamps) between (not over) pipe notches and tighten to 35 ft. lbs. torque.
16. Align tips and tighten hardware. Loosen clamps to rotate or slide pipe for better alignment (fig. 25).
17. Before starting your vehicle, make sure to check all wires, hoses, brake lines, body parts and tires for safe clearance from the exhaust system.
18. Start vehicle and check for any leaks. If any leaks are found, determine cause (such as loose or incorrectly positioned clamp) and repair as necessary.

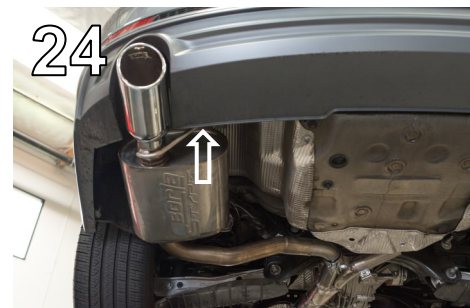
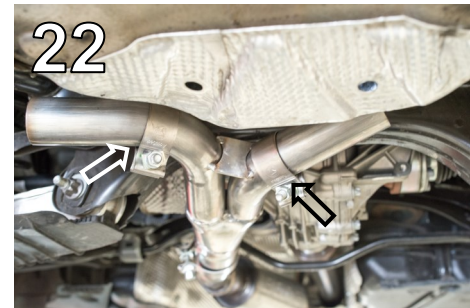
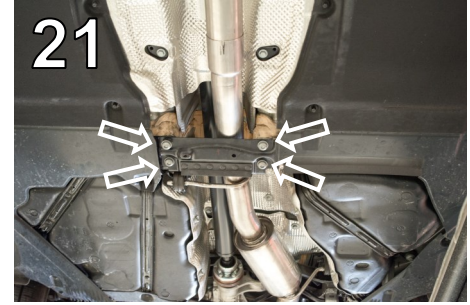

WARNING: Use extreme caution during installation. Torque all fasteners according to manufacturer's torque values and tightening sequence. **DO NOT** use air impact tools to tighten fasteners on Borla Performance Exhaust Systems. Use of such tools may result in bent flanges or gasket contact areas leading to exhaust leaks.

NOTE: When you first start your vehicle after the installation of your new Borla Performance Exhaust System, there may be some smoke and fumes coming from the system. This is a protective oil based coating used in the manufacturing of mandrel bent performance exhaust tubing. This is not a problem and will disappear within a very short period of time after the exhaust has reached normal operating temperatures.