

Installation Manual for RAM 1500 PNs 140752, 140753, 140758, 60667



******* Please compare the parts in the box with the bill of materials provided *****
to assure that you have all the parts necessary for this installation.**

These instructions have been written to help you with the installation of your Borla Performance exhaust system. Please read this document completely before beginning the installation of your system.

Thank you for purchasing a Borla Performance Cat-Back™ exhaust system.

Borla Performance Cat-Back™ exhaust system PNs 140752, 140753, 140758 are designed for the RAM 1500 equipped with a 5.7L V8 engine, automatic transmission.

Borla Performance front muffler option PN 60667 is designed to pair with Borla Performance Cat-Back™ PNs 140752 and 140753.

Borla Performance Industries recommends that an exhaust shop or professional after market parts installer, who has all the necessary equipment, tools and experienced personnel needed for proper installation, should perform the installation of this system. However, if you decide to perform the installation, we recommend someone should help you. Ensure the installer uses all under car safety precautions including eye protection.

Please take time to read and understand the following...

By installing your Borla Performance exhaust system, you indicate that you have read this document and you agree with the terms stated below.

It is the responsibility of the purchaser to follow all installation instruction guidelines and safety procedures supplied with your Borla Performance exhaust system.

Borla Performance Industries assumes no responsibility for damages occurring from misuse, abuse, improper installation, improper operation, lack of responsible care, or all previously stated reasons resulting from incompatibility with other manufacturer's products and/or systems.

Included with your Borla Performance exhaust system is a warranty card. Please read it carefully before you begin any work on your vehicle. If you should have any questions regarding our warranty policy, installation, or any other matter pertaining to your new Borla Performance Exhaust System, please give us a call at the number provided on the warranty card.

Minimum Required Tool List:

TOOLS:

1. 3/8" drive ratchet
2. 16mm socket
3. 15mm deep well socket
4. 13mm socket
5. Pry bar
6. Reciprocating saw

SHOP SUPPLIES:

1. Spray lubricant

Borla Performance - Bill of Materials

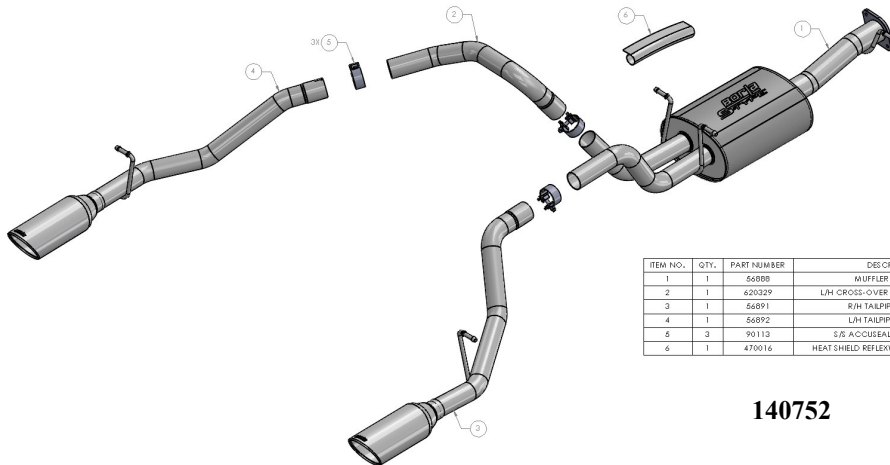

ITEM NO.	QTY.	PART NUMBER	DESCRIPTION
1	1	56000	MUFFLER ASSEMBLY
2	1	620329	L/H CROSS-OVER PIPE:Ø2,50 X 27,75"
3	1	56891	R/H TAILPIPE ASSEMBLY
4	1	56892	L/H TAILPIPE ASSEMBLY
5	3	90113	3/8" ACOUSTICAL CLAMP Ø2,50
6	1	470016	HEAT SHIELD REFLEXWRAP: Ø1,12 X 11,00"

140752

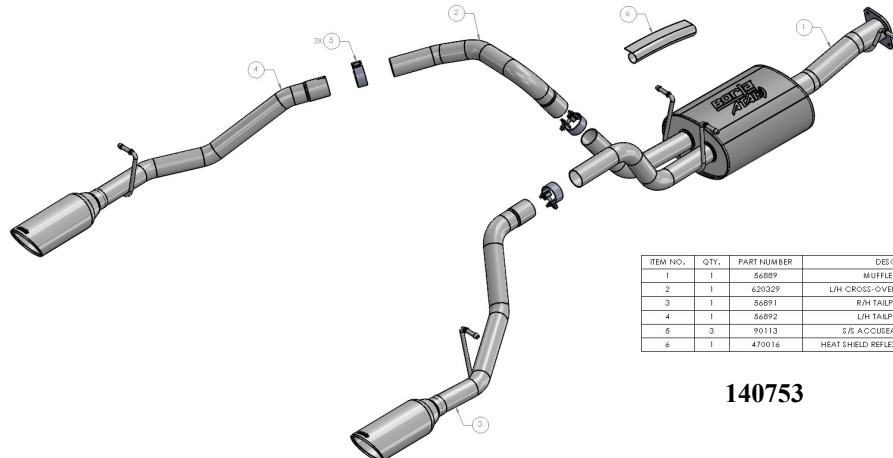

ITEM NO.	QTY.	PART NUMBER	DESCRIPTION
1	1	56009	MUFFLER ASSEMBLY
2	1	620329	L/H CROSS-OVER PIPE:Ø2,50 X 27,75"
3	1	56891	R/H TAILPIPE ASSEMBLY
4	1	56892	L/H TAILPIPE ASSEMBLY
5	3	90113	3/8" ACOUSTICAL CLAMP Ø2,50
6	1	470016	HEAT SHIELD REFLEXWRAP: Ø1,12 X 11,00"

140753

Borla Performance - Bill of Materials cont'd

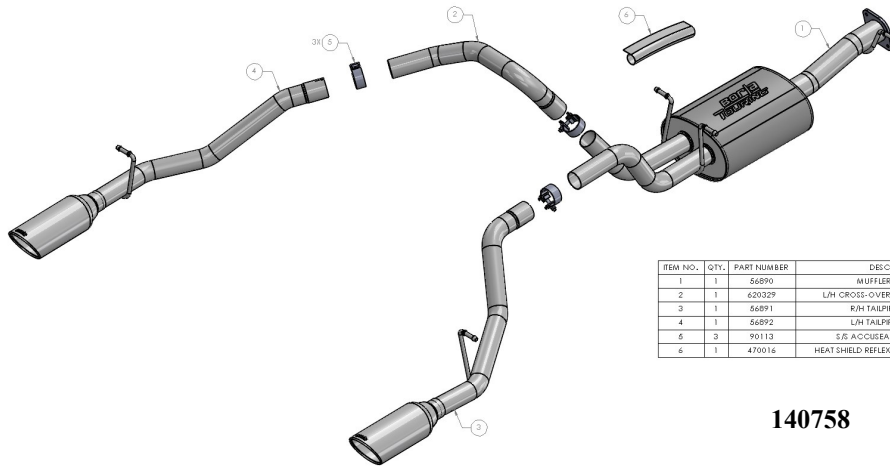

ITEM NO.	QTY.	PART NUMBER	DESCRIPTION
1	1	5690	MUFFLER ASSEMBLY
2	1	620329	L/H CROSS-OVER PIPE Ø2.50 X 27.75"
3	1	5691	R/H TAILPIPE ASSEMBLY
4	1	5692	L/H TAILPIPE ASSEMBLY
5	3	90113	5/8" A/C CUSEAL CLAMP Ø2.50
6	1	470016	HEAT SHIELD REFLEXWRAP: Ø1.12 X 11.00"

140758

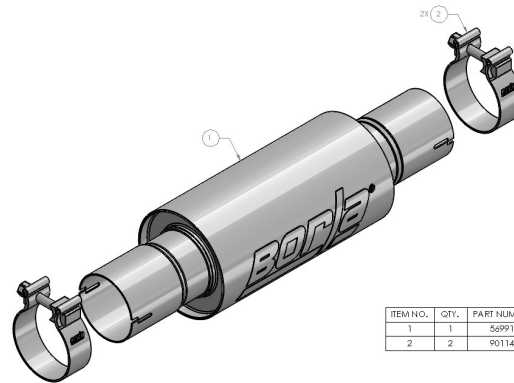

ITEM NO.	QTY.	PART NUMBER	DESCRIPTION
1	1	5691	MUFFLER ASSEMBLY
2	2	90114	3.00" A/C CUSEAL CLAMP

60667

Caution!!! Never work on a hot exhaust system. Serious injury in the form of burns can result if the vehicle has been in use and the exhaust system is hot, allow vehicle to cool for at least 1 hour. Always wear eye protection when working under any vehicle.

Note: It is our recommendation that you use a hoist or hydraulic lift to facilitate the installation of your new Borla Performance Exhaust System.

Taking all under car safety precautions, lift the vehicle using a hoist or hydraulic lift. Once this has been done, you may begin the removal of your old exhaust system from your vehicle.

Note: Before removing the original exhaust system from your vehicle, please compare the parts you have received with the bill of materials provided on the previous page to assure that you have all the parts necessary for the installation of your new Borla Performance Exhaust System.

Note: With a used vehicle, we suggest a penetrating spray lubricant to be applied liberally to all exhaust fasteners and allowing a significant period of time for the chemical to lubricate the threads before attempting to disassemble.

Original Exhaust System Removal

1. Lubricate all hangers, rubber isolators, bolts and nuts.
2. To make the removal and installation of your exhaust easier, remove or raise the spare tire as recommended by vehicle manufacture (fig. 1).
3. Unbolt band clamps on the R/H tailpipe assembly and L/H tip assembly. (figs. 2 & 3).
4. Unbolt the flange on the muffler assembly (fig. 4).
5. Unbolt the L/H sway bar end link for better clearance and place the hardware aside for reinstallation later. If necessary, make cuts using a reciprocating saw for better clearance (fig. 5).

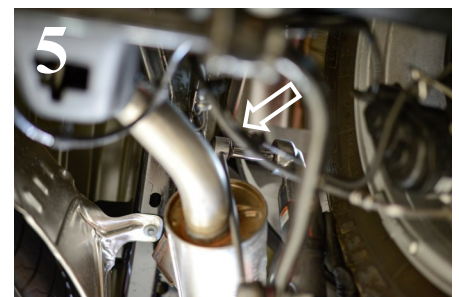
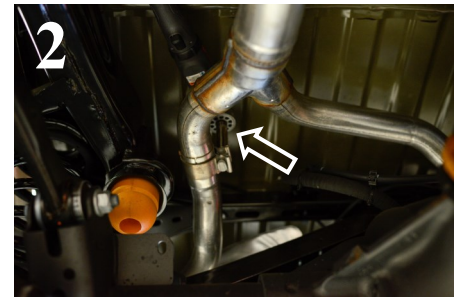

Caution!!! Never work on a hot exhaust system. Serious injury in the form of burns can result if the vehicle has been in use and the exhaust system is hot, allow vehicle to cool for at least 1 hour. Always wear eye protection when working under any vehicle.

Note: It is our recommendation that you use a hoist or hydraulic lift to facilitate the installation of your new Borla Performance Exhaust System.

Taking all under car safety precautions, lift the vehicle using a hoist or hydraulic lift. Once this has been done, you may begin the removal of your old exhaust system from your vehicle.

Note: Before removing the original exhaust system from your vehicle, please compare the parts you have received with the bill of materials provided on the previous page to assure that you have all the parts necessary for the installation of your new Borla Performance Exhaust System.

Note: With a used vehicle, we suggest a penetrating spray lubricant to be applied liberally to all exhaust fasteners and allowing a significant period of time for the chemical to lubricate the threads before attempting to disassemble.

Original Exhaust System Removal Cont'd

6. Loosen factory band clamp on R/H tailpipe assembly (fig. 6).
7. Loosen (2) factory band clamps on R/H and L/H tailpipe assemblies near muffler assembly (fig. 7).
8. Use a muffler stand or an additional person to support the muffler assembly. Remove the hangers from rubber isolators and remove the muffler assembly from the vehicle (fig. 8).
9. Remove the hangers from rubber isolators and remove the L/H and R/H tailpipe assemblies from the vehicle (fig. 9).
10. OE exhaust system removed.

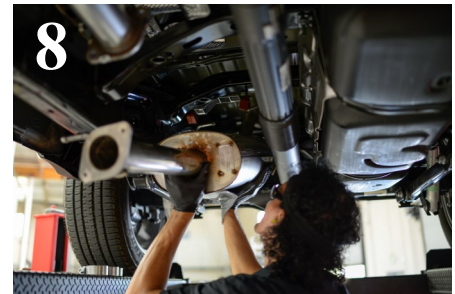

Borla Performance Cat-Back™ Exhaust System Installation

1. Orient components on floor referencing the page-2 drawing.
2. Raise Borla rear muffler assembly (fig. 10) and insert L/H and R/H rear muffler assembly hangers into rubber isolators. Tighten bolts on Borla rear muffler assembly flange (fig. 11).
3. Slide band clamps over Borla muffler assembly outlet pipes. Referencing the page-2 drawing for orientation, place expanded ends of Borla L/H mid-pipe and R/H tailpipe over muffler assembly outlet pipes (fig. 12).
4. Slide band clamp over Borla L/H tailpipe and slide the expanded end of the Borla L/H tailpipe assembly over the Borla mid-pipe (fig. 13).
5. Insert Borla L/H tailpipe hanger into OE rubber isolator (fig. 14).

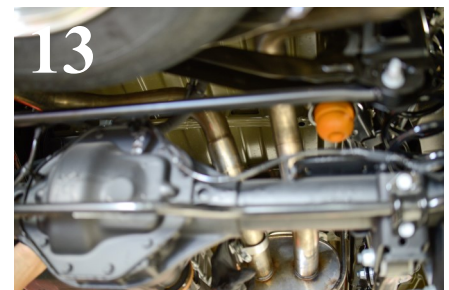
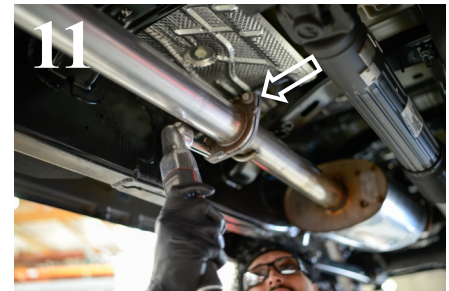

WARNING: Use extreme caution during installation. Torque all fasteners according to manufacturer's torque values and tightening sequence. **DO NOT** use air impact tools to tighten fasteners on Borla Performance Exhaust Systems. Use of such tools may result in bent flanges or gasket contact areas leading to exhaust leaks.

NOTE: When you first start your vehicle after the installation of your new Borla Performance Exhaust System, there may be some smoke and fumes coming from the system. This is a protective oil based coating used in the manufacturing of mandrel bent performance exhaust tubing. This is not a problem and will disappear within a very short period of time after the exhaust has reached normal operating temperatures.

Borla Performance Cat-Back™ Exhaust System Installation (cont'd)

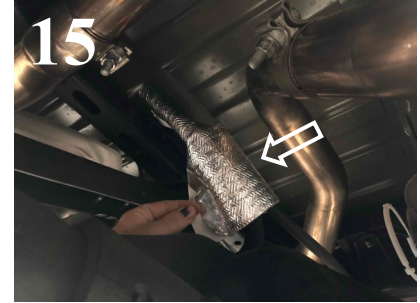

5. Install provided heat shield over brake lines directly over the vehicle's differential, closest to Borla L/H tailpipe. Heat shield should be installed at the point with the lowest clearance relative to the Borla exhaust pipes (fig. 15).
6. Check your exhaust system for proper clearance under the vehicle and also for tip alignment. Starting at front flanges and moving to rear of vehicle, tighten flange hardware bolts. Orient position of bolt (on supplied clamps) between (not over) pipe notches and tighten to 35 ft. lbs. torque.
7. Align tips and tighten hardware. Loosen clamps to rotate or slide pipe for better alignment.
8. Before starting your vehicle, make sure to check all wires, hoses, brake lines, body parts and tires for safe clearance from the exhaust system.
9. Start vehicle and check for any leaks. If any leaks are found, determine cause (such as loose or incorrectly positioned clamp) and repair as necessary.

WARNING: Use extreme caution during installation. Torque all fasteners according to manufacturer's torque values and tightening sequence. **DO NOT** use air impact tools to tighten fasteners on Borla Performance Exhaust Systems. Use of such tools may result in bent flanges or gasket contact areas leading to exhaust leaks.

NOTE: When you first start your vehicle after the installation of your new Borla Performance Exhaust System, there may be some smoke and fumes coming from the system. This is a protective oil based coating used in the manufacturing of mandrel bent performance exhaust tubing. This is not a problem and will disappear within a very short period of time after the exhaust has reached normal operating temperatures.

Borla Performance Optional Front Muffler Installation



1. Using a reciprocating saw with a metal-cutting blade, make a cut directly next to the front and rear welds of the OE front muffler (figs. A, B).
2. OE front muffler removed. Loosen hardware and remove OE front flange, and keep for reinstallation (fig. C).
3. Loosen bolts on OE front pipe rear flange (fig. D).
4. Connect OE front flange to Borla front muffler (fig. E).
5. Connect outlet of Borla front muffler to OE front pipe.
6. Borla front muffler installed.
7. Check your exhaust system for proper clearance under the vehicle and also for tip alignment. Starting at front flanges and moving to rear of vehicle, tighten flange hardware bolts. Orient position of bolt (on supplied clamps) between (not over) pipe notches and tighten to 35 ft. lbs. torque.
8. Align tips and tighten hardware. Loosen clamps to rotate or slide pipe for better alignment.
9. Before starting your vehicle, make sure to check all wires, hoses, brake lines, body parts and tires for safe clearance from the exhaust system.
10. Start vehicle and check for any leaks. If any leaks are found, determine cause (such as loose or incorrectly positioned clamp) and repair as necessary.

WARNING: Use extreme caution during installation. Torque all fasteners according to manufacturer's torque values and tightening sequence. **DO NOT** use air impact tools to tighten fasteners on Borla Performance Exhaust Systems. Use of such tools may result in bent flanges or gasket contact areas leading to exhaust leaks.

NOTE: When you first start your vehicle after the installation of your new Borla Performance Exhaust System, there may be some smoke and fumes coming from the system. This is a protective oil based coating used in the manufacturing of mandrel bent performance exhaust tubing. This is not a problem and will disappear within a very short period of time after the exhaust has reached normal operating temperatures.

Borla Performance Optional Front Muffler Installation Cont'd

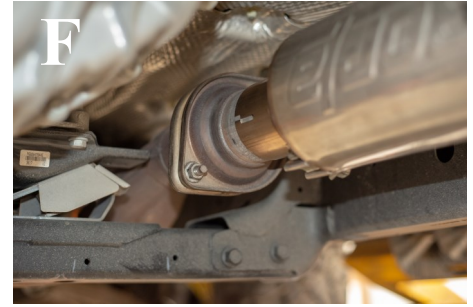

6. Tighten hardware on OE front pipe rear flange (fig. F).
7. Tighten hardware on OE front pipe front flange (fig. G).
8. Check your exhaust system for proper clearance under the vehicle and also for tip alignment. Starting at front flanges and moving to rear of vehicle, tighten flange hardware bolts. Orient position of bolt (on supplied clamps) between (not over) pipe notches and tighten to 35 ft. lbs. torque (figs. H & I).
9. Tighten hardware. Loosen clamps to rotate or slide pipe for better alignment.
10. Before starting your vehicle, make sure to check all wires, hoses, brake lines, body parts and tires for safe clearance from the exhaust system.
11. Start vehicle and check for any leaks. If any leaks are found, determine cause (such as loose or incorrectly positioned clamp) and repair as necessary.

WARNING: Use extreme caution during installation. Torque all fasteners according to manufacturer's torque values and tightening sequence. **DO NOT** use air impact tools to tighten fasteners on Borla Performance Exhaust Systems. Use of such tools may result in bent flanges or gasket contact areas leading to exhaust leaks.

NOTE: When you first start your vehicle after the installation of your new Borla Performance Exhaust System, there may be some smoke and fumes coming from the system. This is a protective oil based coating used in the manufacturing of mandrel bent performance exhaust tubing. This is not a problem and will disappear within a very short period of time after the exhaust has reached normal operating temperatures.