

Exhaust System Installation PNs-140741, 140750, 140751



******* Please compare the parts in the box with the bill of materials provided *****
to assure that you have all the parts necessary for this installation.**

These instructions have been written to help you with the installation of your Borla Performance Exhaust System. Please read this document completely before beginning the installation of your system.

Thank you for purchasing a Borla Performance Exhaust System.

Borla Performance Cat-Back™ Exhaust System (PN-140741) is designed for the Seat Leon Cupra equipped with a 2.0T 4-cylinder turbo engine, automatic or manual transmissions.

Borla Performance Cat-Back™ Exhaust Systems (PN-140750, 140751) are designed for the Volkswagen Golf GTI equipped with a 2.0T 4-cylinder turbo engine, automatic or manual transmissions.

Borla Performance Industries recommends that an exhaust shop or professional after market parts installer perform the installation of this system. However, if you decide to perform the installation on your own it is recommended that two people are used. This installation should not be performed by one person due to the risk of injury. Ensure the installers use all under car safety precautions including eye protection.

Please take time to read and understand the following...

By installing your Borla Performance Exhaust System, you indicate that you have read this document and you agree with the terms stated below.

It is the responsibility of the purchaser to follow all installation instruction guidelines and safety procedures supplied with your Borla Performance Exhaust System.

Borla Performance Industries assumes no responsibility for damages occurring from misuse, abuse, improper installation, improper operation, lack of responsible care, or all previously stated reasons resulting from incompatibility with other manufacturer's products and/or systems.

Included with your Borla Performance Exhaust System is a warranty card. Please read it carefully before you begin any work on your vehicle. If you should have any questions regarding our warranty policy, installation, or any other matter pertaining to your new Borla Performance Exhaust System, please give us a call at the number provided on the warranty card.

Minimum Required Tool List:

TOOLS:

- 1 3/8" Drive Ratchet
- 2 3/8" Drive Extension 3"
- 3 13mm Socket
- 4 15mm Socket
- 5 16mm Socket
- 6 Pry Bar

SHOP SUPPLIES:

- 1 Spray Lubricant

Borla Performance Bill of Materials

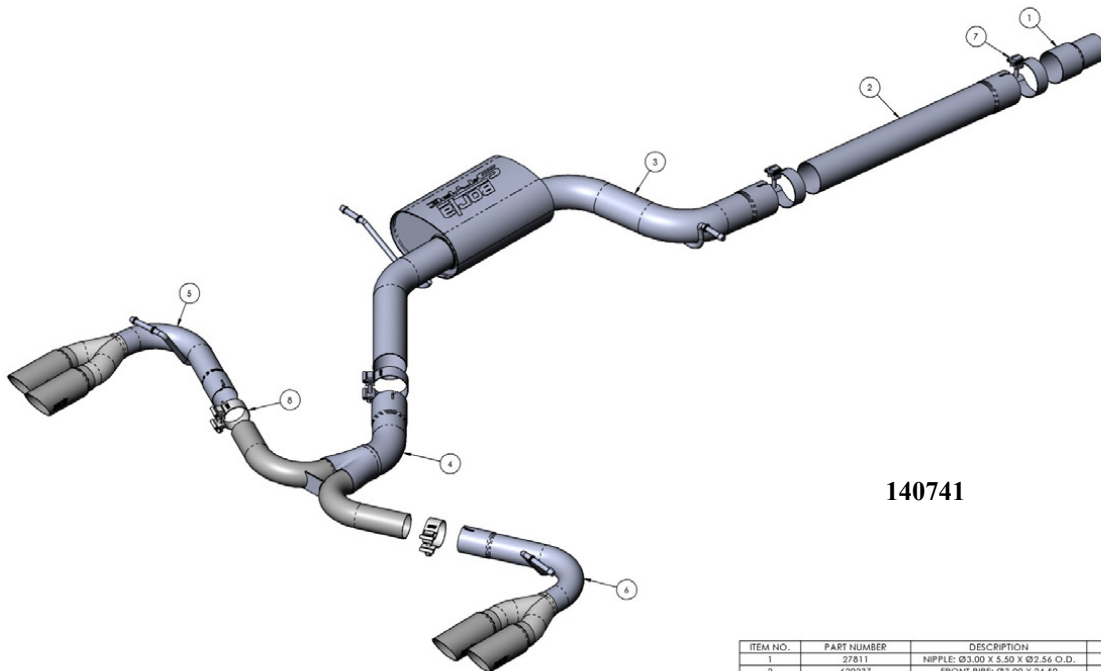

140741

ITEM NO.	PART NUMBER	DESCRIPTION	QTY.
1	27811	NIPPLE: 03.00 X 3.50 X 02.56 O.D.	1
2	420237	FRONT PIPE: 03.00 X 24.50	1
3	56842	MUFFLER ASSEMBLY	1
4	56843	Y-PIPE ASSEMBLY	1
5	5684458	L/H TAILPIPE ASSEMBLY	1
6	5684558	R/H TAILPIPE ASSEMBLY	1
7	90114	3.00 ACCUSEAL CLAMP	3
8	90112	2.25 ACCUSEAL CLAMP	2

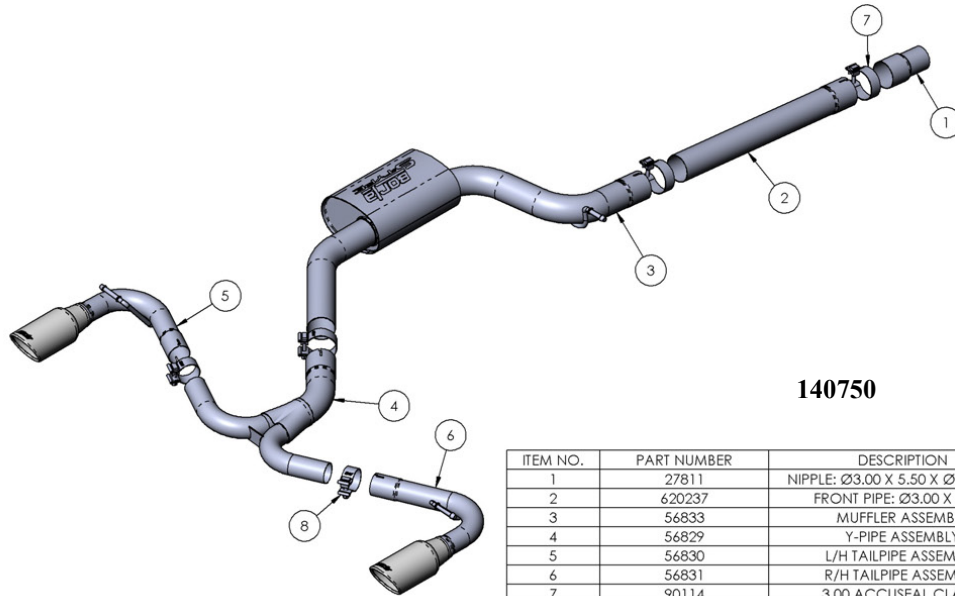

140750

ITEM NO.	PART NUMBER	DESCRIPTION	QTY.
1	27811	NIPPLE: Ø3.00 X 5.50 X Ø2.56 O.D.	1
2	620237	FRONT PIPE: Ø3.00 X 24.50	1
3	56833	MUFFLER ASSEMBLY	1
4	56829	Y-PIPE ASSEMBLY	1
5	56830	L/H TAILPIPE ASSEMBLY	1
6	56831	R/H TAILPIPE ASSEMBLY	1
7	90114	3.00 ACCUSEAL CLAMP	3
8	90112	2.25 ACCUSEAL CLAMP	2

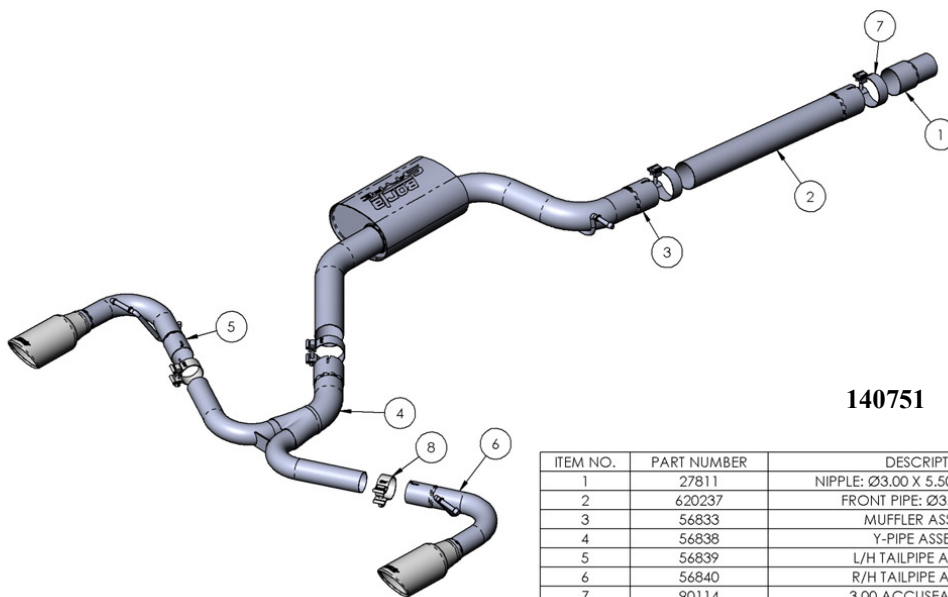

140751

ITEM NO.	PART NUMBER	DESCRIPTION	QTY.
1	27811	NIPPLE: Ø3.00 X 5.50 X Ø2.56 O.D.	1
2	620237	FRONT PIPE: Ø3.00 X 24.50	1
3	56833	MUFFLER ASSEMBLY	1
4	56838	Y-PIPE ASSEMBLY	1
5	56839	L/H TAILPIPE ASSEMBLY	1
6	56840	R/H TAILPIPE ASSEMBLY	1
7	90114	3.00 ACCUSEAL CLAMP	3
8	90112	2.25 ACCUSEAL CLAMP	2

Caution!!! *Never work on a hot exhaust system. Serious injury in the form of burns can result. If the vehicle has been in use and the exhaust system is hot, allow vehicle to cool for at least 1 hour. Always wear eye protection when working under any vehicle.*

Note: *It is our recommendation that you use a hoist or hydraulic lift to facilitate the installation of your new Borla Performance Exhaust System.*

Taking all under car safety precautions, lift the vehicle using a hoist or hydraulic lift. Once this has been done, you may begin the removal of your old exhaust system from your vehicle.

Note: *Before removing the original exhaust system from your vehicle, please compare the parts you have received with the bill of materials provided on the previous page to assure that you have all the parts necessary for the installation of your new Borla Performance Exhaust System.*

Note: *With a used vehicle, we suggest a penetrating spray lubricant to be applied liberally to all exhaust fasteners and allowing a significant period of time for the chemical to lubricate the threads before attempting to disassemble.*

Original Exhaust System Removal

1. Loosen the (2) clamp bolts as shown (13mm) and slide clamp towards front of vehicle. (See Fig.1)
2. Remove cross-member behind front muffler. Keep hardware for reinstallation.
3. Using a muffler stand or an additional person to hold the muffler assembly up into position, slide the (5) hangers out of the rubber isolators and remove the system from the rear. (See Fig. 2) Keep the hardware for use during the installation of your new exhaust system.
4. Exhaust system removed. (See Fig. 3)

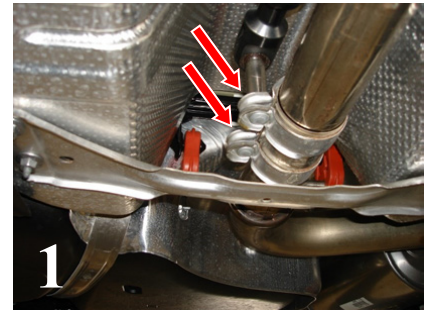

Borla Performance Cat-Back™ Exhaust System Installation

1. Place an Accuseal clamp on the expanded end of the **3" Adaptor** and insert reduced end into the outlet of the OE downpipe. Do not tighten the clamp bolt. (See Fig. 4)
2. Insert the **Front Muffler Assembly** into the **3" Adaptor**. Slide and position the clamp with the bolts accessible to tighten later. Do not tighten the clamp bolts. (See Fig. 5)
3. Place a 3.0" Accuseal clamp over the **Rear Muffler Assembly** and insert into the **Front Muffler Assembly** outlet. Insert hanger into rubber isolator (Seat Leon Cupra only). Do not tighten the clamp bolts.
4. Place a 3.0" Accuseal clamp over the **Y-Pipe Assembly** and insert inlet into the **Rear Muffler Assembly**. (See Fig. 6)
5. Place a 2.25" Accuseal clamp over the **L/H Tail Pipe Assembly** and insert inlet into the **Y-Pipe Assembly**. Insert hanger into rubber isolators. (See Fig. 7)
6. Repeat STEP 5 for to install the **R/H Tail Pipe Assembly**.

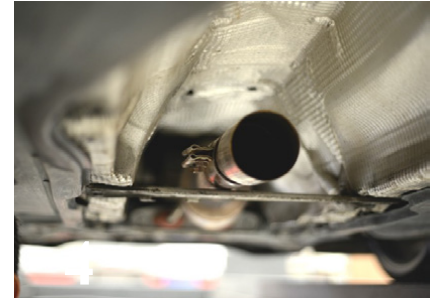

WARNING: Use extreme caution during installation. Torque all fasteners according to manufacturer's torque values and tightening sequence. **DO NOT** use air impact tools to tighten fasteners on Borla Performance Exhaust Systems. Use of such tools may result in bent flanges or gasket contact areas leading to exhaust leaks.

NOTE: When you first start your vehicle after the installation of your new Borla Performance Exhaust System, there may be some smoke and fumes coming from the system. This is a protective oil based coating used in the manufacturing of mandrel bent performance exhaust tubing. This is not a problem and will disappear within a very short period of time after the exhaust has reached normal operating temperatures.

Borla Performance Cat-Back™ Exhaust System Installation

- Slide the Accuseal clamps over the notches and rotate the clamp-bolt 90-degrees from the notches. The clamp-bolt should be positioned between the notches. (See Fig. 6) Do not tighten this bolt. *NOTE: When properly clamped, the Accuseal pipe closes in a circular-shape with interlocking notches creating a proper seal. The pipe will distort or ovalize in shape if the clamp-bolt is positioned over the notches.*
- Check your exhaust system for proper clearance under the vehicle and also for tip alignment. Once position has been determined to be correct, tighten the Accuseal™ clamp 32-35 ft. lbs. Tighten the OE clamp bolts. (See Fig. 7)
- Start vehicle and check for any leaks. If any leaks are found, determine cause (such as loose or incorrectly positioned clamp) and repair as necessary.



WARNING: Use extreme caution during installation. Torque all fasteners according to manufacturer's torque values and tightening sequence. **DO NOT** use air impact tools to tighten fasteners on Borla Performance Exhaust Systems. Use of such tools may result in bent flanges or gasket contact areas leading to exhaust leaks.

NOTE: When you first start your vehicle after the installation of your new Borla Performance Exhaust System, there may be some smoke and fumes coming from the system. This is a protective oil based coating used in the manufacturing of mandrel bent performance exhaust tubing. This is not a problem and will disappear within a very short period of time after the exhaust has reached normal operating temperatures.