

Cat-Back Installation for Infiniti FX50 PN 140339



Thank you for purchasing a Borla Performance Cat-Back™ Exhaust System.

Borla Performance Exhaust System (PN-140339) has been designed for the Infiniti FX-50 equipped with a 5.0L engine, all-wheel drive and automatic transmission.

Borla Performance Industries recommends that an exhaust shop or professional after market parts installer perform the installation of this system. However, if you decide to perform the installation on your own it is recommended that two people are used. This installation should not be performed by one person due to the risk of injury. Ensure the installers use all under car safety precautions including eye protection.

Please take time to read and understand the following...

By installing your Borla Performance Exhaust System, you indicate that you have read this document and you agree with the terms stated below.

It is the responsibility of the purchaser to follow all installation instruction guidelines and safety procedures supplied with your Borla Performance Exhaust System

Borla Performance Industries assumes no responsibility for damages occurring from misuse, abuse, improper installation, improper operation, lack of responsible care, or all previously stated reasons resulting from incompatibility with other manufacturer's products and/or systems.

Minimum Required Tool List:

TOOLS:

- 1 3/8” Drive Ratchet
- 2 3/8” Drive Extension 3”
- 3 14mm Sockets
- 4 Pry Bar

SHOP SUPPLIES:

- 1 Spray Lubricant

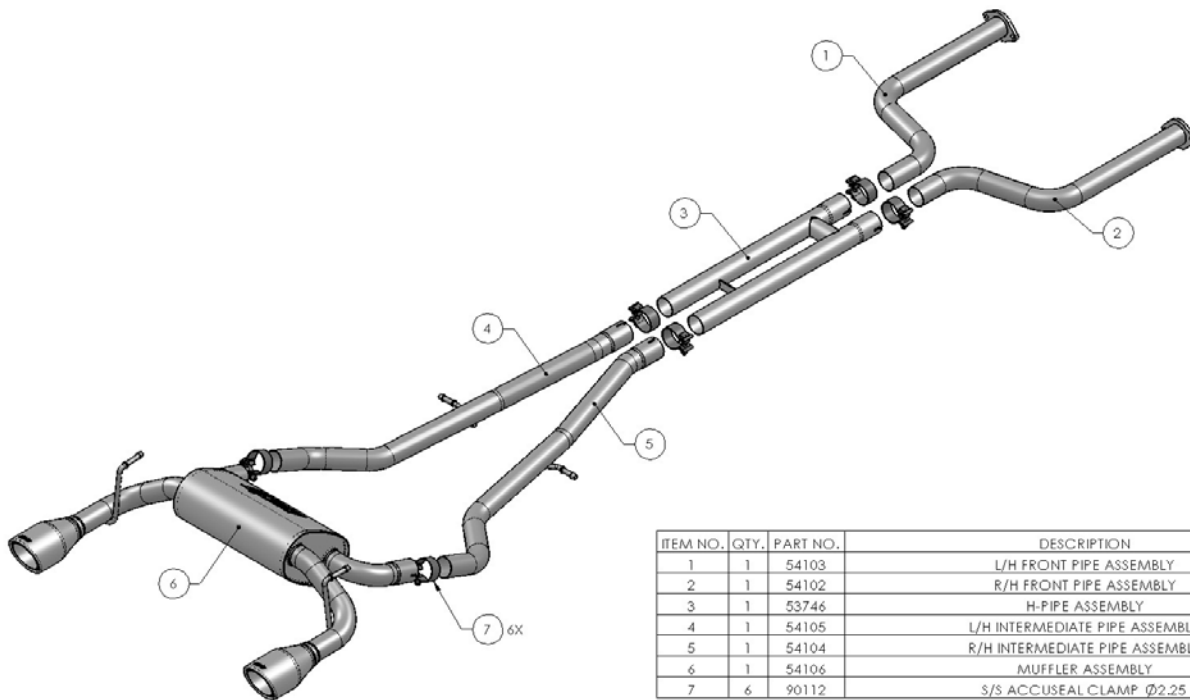

ITEM NO.	QTY.	PART NO.	DESCRIPTION
1	1	54103	L/H FRONT PIPE ASSEMBLY
2	1	54102	R/H FRONT PIPE ASSEMBLY
3	1	53746	H-PIPE ASSEMBLY
4	1	54105	L/H INTERMEDIATE PIPE ASSEMBLY
5	1	54104	R/H INTERMEDIATE PIPE ASSEMBLY
6	1	54106	MUFFLER ASSEMBLY
7	6	90112	S/S ACCUSEAL CLAMP Ø2.25

Borla Performance Bill of Materials

- 1. R/H Front Pipe assembly
- 2. L/H Front Pipe assembly
- 3. H-Pipe assembly
- 4. R/H Intermediate Pipe assembly
- 5. L/H Intermediate Pipe assembly
- 6. Muffler Assy
- 7. S/S Clamp 2.25” (Qty 4)

Caution!!! *Never work on a hot exhaust system. Serious injury in the form of burns can result* If the vehicle has been in use and the exhaust system is hot, allow vehicle to cool for at least 1 hour. Always wear eye protection when working under any vehicle.

Note: It is our recommendation that you use a hoist or hydraulic lift to facilitate the installation of your new Borla Performance Cat-Back™ Exhaust System.

Taking all under car safety precautions, lift the vehicle using a hoist or hydraulic lift. Once this has been done, you may begin the removal of your old exhaust system from your vehicle.

Note: Before removing the original exhaust system from your vehicle, please compare the parts you have received with the bill of materials provided on the previous page to assure that you have all the parts necessary for the installation of your new Borla Performance Cat-Back™ Exhaust System.

Original Exhaust System Removal

Note: With a used vehicle, we suggest a penetrating spray lubricant to be applied liberally to all exhaust fasteners and allowing a significant period of time for the chemical to lubricate the threads before attempting to disassemble.

1. Remove (2) 14mm nuts on left front flange behind the catalytic converter. Repeat for the right side. Save hardware for installation. (See Fig. 1)
2. Remove (2) 14mm nuts from front-flanges in the mid-pipe assembly. Save hardware for installation. Remove front pipe. (See Fig. 2)
3. Lubricate all the hangers and rubber isolators. Remove the hangers from the rubber isolators and carefully remove mid-pipe/rear-muffler assemblies. (See Fig 3)

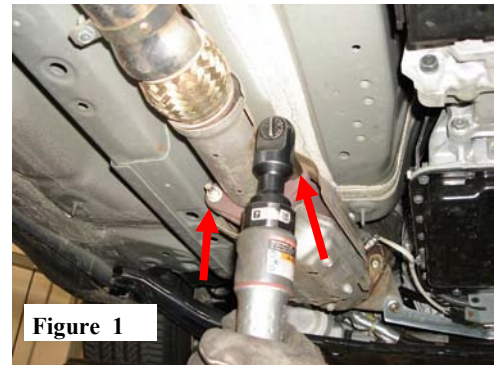

Figure 1

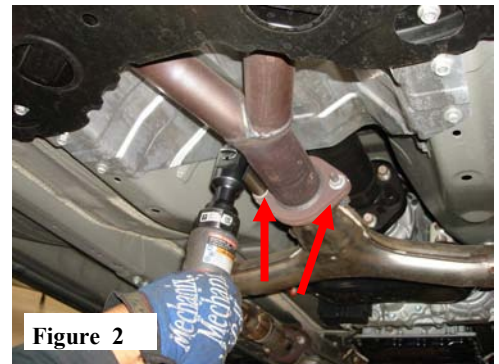

Figure 2



Figure 3

Warning: *Use extreme caution during installation. Torque all fasteners according to manufacturer's torque values and tightening sequence. DO NOT use air impact tools to tighten fasteners on Borla Performance Exhaust Systems. Use of such tools may result in bent flanges or gasket contact areas leading to exhaust leaks.*

Borla Performance Exhaust System Installation

1. Install Left and Right Front Pipe Assemblies using OE hardware. (See Fig 4)
2. Place a clamp over left and right front pipes and install H-Pipe Assembly. (See Fig 5)
3. Place a clamp over Right and Left H-Pipe end and install Left and Right Rear Pipe Assemblies using (2) factory hangar rubber isolators. (See Fig 6)
4. Place a clamp over Right and Left Rear Pipe ends and install Muffler Assembly using (2) factory hangar rubber isolators. (See Fig 7)
5. Check your exhaust system for proper clearance under the vehicle and also for tip alignment.
6. Once position has been determined to be correct, tighten the Accuseal™ clamp to 32-35 ft. lbs. making sure the clamps openings are NOT over any of the notches in the pipes.
7. Before starting your vehicle, make sure to check all wires, hoses, brake lines, body parts and tires for safe clearance from the exhaust system.
8. Start vehicle and check for any leaks. If any leaks are found, determine cause (such as loose hardware or incorrectly positioned clamp) and repair as necessary.

Note: When you first start your vehicle after the installation of your new Borla Performance Exhaust System, there may be some smoke and fumes coming from the system. This is a protective oil based coating used in the manufacturing of mandrel bent performance exhaust tubing. This is not a problem and will disappear within a very short period of time after the exhaust has reached normal operating temperatures.

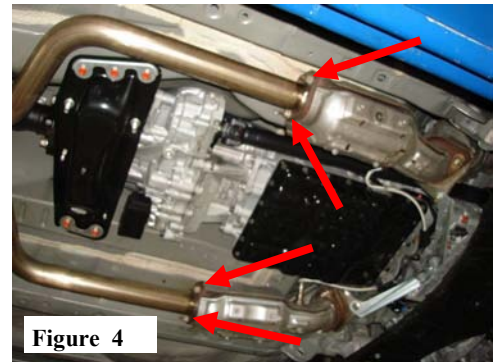

Figure 4

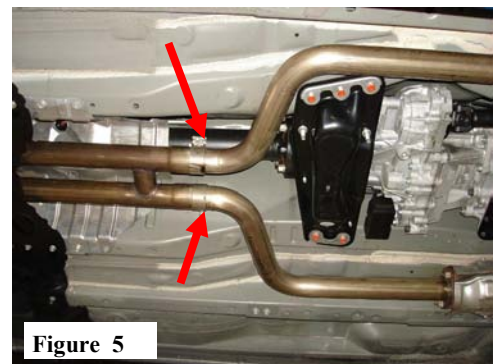

Figure 5

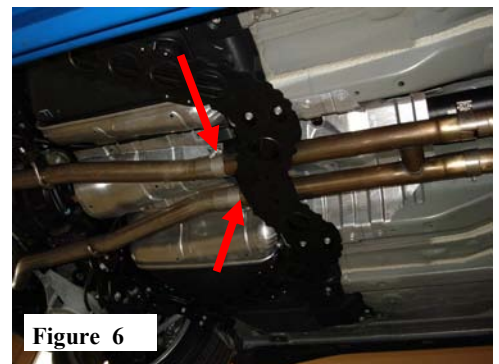

Figure 6

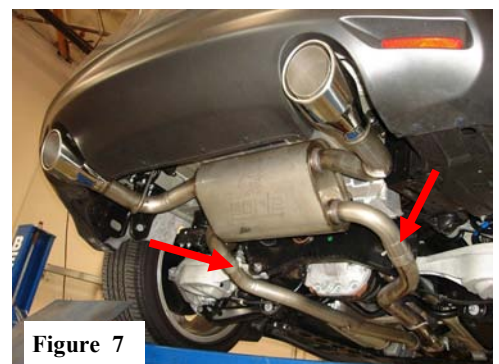

Figure 7