



Installation Instructions

Transkit for '68-'81 TH-350

Part No. 30229

© B&M Automotive Products 1995

The B&M TransKit you have purchased contains all of the parts necessary to convert your stock transmissions to the same basic specifications found in the famous B&M Transmission. This kit has been assembled with the assumption that all of the stock parts needed will be reusable. However, upon disassembly of a transmission that has excessive mileage or has been abused, you may find that certain stock parts will have to be replaced. New parts may be purchased from your GM dealer although in many instances you may wish to purchase used parts from a wrecking yard or transmission repair shop.

Stock friction materials are more than sufficient in all other instances and do not be afraid to reuse your existing parts as long as they appear in good shape.

We suggest that you take the time to completely read through the instructions before beginning disassembly so that you will be properly prepared with all of the necessary tools and materials. (See Tool and Material List.) When reading the instructions without the disassembled transmission in front of you, you may be confused. Do not concern yourself. With the transmission actually apart you will find the instructions are simple and easy to follow.

Warning: This kit allows downshifts at any speed.

Note: This kit will not fit a 1980-86 TH-350C transmission. The TH-350C is equipped with a clutch converter and can be identified by an electrical connector on the driver side of the transmission above the pan gasket.

Additional B&M Parts

While you have your transmission apart there are a number of other B&M accessories that you may want to consider:

1. **Torque Converter.** For street applications we recommend either our 11" Holeshot 2400 or, for those that want a little

more performance the 10" Holeshot 3000 is an excellent choice. For racing applications we recommend you will want to choose a 8" or 10" Race Converter. For RV/Heavy Duty applications we recommend our Traveler Converter which has slightly more stall than stock and provides additional torque for taking off with heavy loads or trailers. The Traveler also provides for improved downhill braking effect as well. For more converter information, write for our special converter brochure or consult the B&M catalog.

2. **Deep Pan.** The special cast aluminum B&M Deep Pan (#30280) not only looks good it adds extra oil capacity for longer life and cooler temperatures, plus it actually makes the transmission case more rigid, an important consideration for competition and off-road vehicles.
3. **Vacuum Modulator.** B&M offers adjustable vacuum modulators for the TH-350 transmission. The adjustable feature allows you to tailor your shift points within a range of 2-4 mph.
4. **Manual Valve Body.** For all-out competition where full manual control is desired B&M offers a special Manualpak (#30219). This kit provides features that we are unable to offer in the TransKit. Consult B&M catalog for details on Manualpak features. B&M also offers a transbrake for TH350 applications (#21005).
5. **Transmission Oil Cooler.** We feel that it is very important that every vehicle used in a heavy duty application: racing, towing, RV, etc., should have a supplementary transmission oil cooler. B&M now offers a very low cost cooler that features excellent efficiency and high oil flow.

SPECIAL NOTE: If your present transmission has a Shift Improver Kit installed make sure you remove all of those parts before making the modifications outlined in the TransKit.

INTRODUCTION

The B&M TransKit contains all special parts, friction materials, and gaskets to modify your stock transmission to B&M specifications. Included in the instructions are optional machining modifications B&M performs to their units.

This kit can be installed in a few hours by carefully following directions. Read all instructions first to familiarize yourself with the parts and procedures. Work slowly and do not force any parts. Transmission components and valves are precision fit parts. Burrs and dirt are the number one enemies of an automatic transmission. Cleanliness is very important, so a clean work bench or area is necessary during assembly. Every attempt has been made to simplify assembly and minimize the use of special tools. For additional reference you may wish to obtain a shop manual from the vehicle manufacturer or an aftermarket reference book company.

Since this kit involves a complete overhaul the transmission will have to be removed from the vehicle. Due to the many different models available we cannot cover each vehicle in detail. Included, however, are basic removal and replacement instructions.

This kit contains all parts necessary to obtain any of three levels of performance depending on intended use:

1. Heavy Duty: Towing, campers, motorhomes, police, taxi, etc. This is a heavy duty modification intended for high capacity without harsh shift feel.
2. Street: Dual purpose performance vehicles. Also on/off-road performance. Firm positive shift feel but acceptable for daily street driving.
3. Competition: Race cars only. Not to be driven on the street. Extremely high shift points are unsuitable for street use. Maximum shift feel. Trailered or towed race vehicles only.

Automatic transmissions operate between 150°F and 250°F. It is suggested that the vehicle be allowed to cool for a few hours to avoid burns from hot oil and parts. The vehicle must be off the ground for ease of transmission removal. Jack stands, wheel ramps, or a hoist will work fine. Make sure the vehicle is firmly supported! Try to raise it 1-2 feet so you have plenty of room to work easily. A transmission or floor jack should be used to prevent injury and/or transmission damage during transmission removal. Have a small box or pan handy to put bolts in so they won't get lost. Also have a drain pan handy to catch oil.

TRANSMISSION REMOVAL

STEP 1. Some Turbo Hydro 350 transmissions do not have drain plugs. You will be installing a drain plug kit in the pan later but for now you will have to drain the oil pan by loosening the bolts and allowing the oil to drain past the pan gasket. Loosen the pan bolts slowly but do not remove them. If the pan sticks to the gasket pry it loose with a screwdriver. After the oil drains snug the pan back into place.

STEP 2. Remove the driveshaft assembly. Be careful not to drop or damage the driveshaft or the smooth bushing/seat diameter of the slip yoke. Now is a good time to clean and inspect your U-joints.

STEP 3. Loosen and disconnect oil cooler lines. Try to use a fitting wrench to avoid damaging the compression fitting nuts on stock oil cooler lines. Also disconnect vacuum line to vacuum modulator. (See Fig. 1)

STEP 4. Disconnect kickdown cable from carburetor. Unbolt bracket from motor. Disconnect shifter linkage. On cable shift models (floor consoles) unbolt cable bracket from pan and

leave cable attached to bracket. Disconnect speedometer cable.

STEP 5. Remove dust pan at front of transmission to expose torque converter. Turn engine over slowly to expose and remove the three converter bolts. The converter will now rotate freely. If it does not, use a screwdriver to pry it back slightly and free it from the crankshaft.

STEP 6. Place jack under transmission. Unbolt and remove the crossmember assembly. It is advisable at this point to remove the cap and rotor from the distributor to prevent damage.

STEP 7. Remove transmission to engine bolts. Pull transmission back slightly away from engine. Make sure the converter doesn't fall out. Lower transmission/converter assembly. It may be necessary to remove dipstick tube now to lower transmission completely. Remove transmission/converter assembly from vehicle.

Once the transmission is completely out of the vehicle the torque converter can be pulled off the front. Some oil will leak out at this time. Drain the torque converter as completely as possible and cover the neck to keep out dirt. There will still be about 1-2 quarts of oil in the transmission. You should plan to disassemble the transmission in an area where this oil can be cleaned up easily. (Note: 4WD models remove transfer case unit now to make disassembly easier.)

There have been several different model TH350 transmissions produced. Where there are differences in disassembly procedures they will be so noted in the instructions. If you find it necessary to replace any transmission hard parts during TransKit installation, make sure to record the information from the accumulator cover on the right side of the case when you go to your G.M. dealer (See Fig. 1)

Modifications will be done in sub-assembly steps to avoid confusion and parts mix-up. Work slowly and follow the directions. If you do not understand a step, read it again. Do not guess at anything. It will also be helpful to make notes on the instructions for model reference.

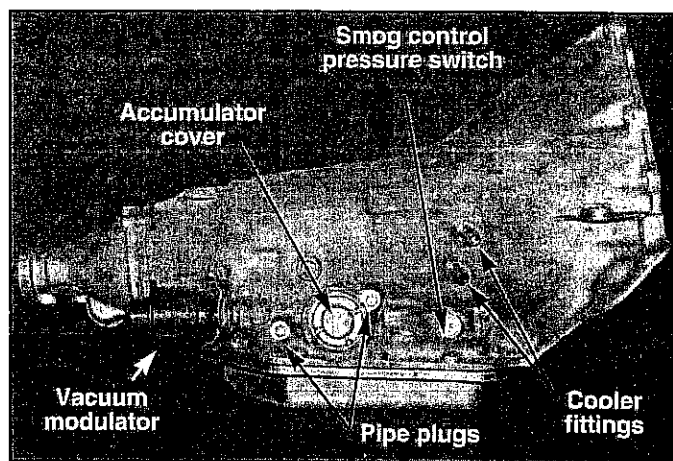

FIGURE 1

DISASSEMBLY

Section A

STEP 1. Remove oil pan. Use the oil pan for a parts tray. Put oil pan bolts in the oil pan. Remove the two oil filter screws. Remove and discard the oil filter and filter gasket.

STEP 2. Observe the location of the following (See Fig. 3): Manual linkage (shifter) detent spring and roller, S-link or offset link, detent valve wire, detent valve pin and spacer support plate.

STEP 3. Remove detent valve pin. (See Fig. 3) Remove lever

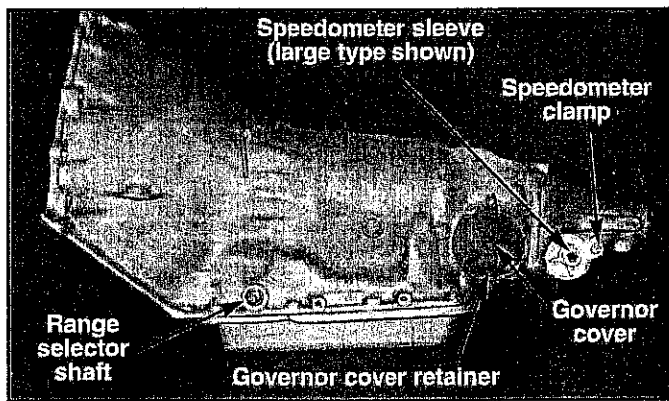

FIGURE 2

also and set them in the oil pan. Remove retaining bolt holding kickdown cable to the case. Remove the cable assembly from the case. Do not lose the detent valve wire.

STEP 4. Remove eighteen valve body attaching bolts. Remove valve body and disengage manual valve and link. (Do not let manual valve fall out of valve body and get bent.) If the valve body gasket sticks, carefully pry up on the valve body with a screwdriver to free it. Set the valve body aside. Discard gasket.

STEP 5. Remove seven spacer support plate bolts and spacer support plate. Set them in oil pan. Remove stock separator plate and gasket and discard the gasket. Remove four check balls from case and set them with the valve body. (See Fig. 4)

STEP 6. Remove the intermediate servo assembly by grasping the intermediate servo piston apply rod and pulling the entire assembly from the case. (See Fig. 4) You will remove: Rod, piston, washer, spring retainer and spring. Put these parts in the oil pan so they won't get lost. Remove and discard piston seal ring if it is metal. **Do not remove Teflon seal ring.** (See Fig. 53)

STEP 7. Remove the vacuum modulator retaining bolt and clamp. (See Fig. 5) Remove vacuum modulator and O-ring. Discard O-ring. Reach into modulator bore in case with a pair of needle nose pliers and carefully remove modulator valve. Set them in the oil pan.

STEP 8. Remove speedometer sleeve retaining bolt and clamp (2 wheel drive models) from extension housing. (See Fig. 2) Pull speedometer sleeve and driven gear out of transmission. Remove and discard O-ring and inner seal on sleeve. Do not lose small retaining clip. Put sleeve, clip, and gear in oil pan.

STEP 9. Remove governor cover retainer. (See Fig. 2) Use a screwdriver to carefully pry cover off case. Be careful not to bend cover. Remove and discard O-ring. Remove governor by pulling straight out. Governor will rotate slightly during removal. Put governor in oil pan.

STEP 10. Remove park lock bracket bolts and bracket. (See Fig. 4) Remove range selector shaft retainer (clip). Loosen and remove shaft nut. Slide shaft out of case. Remove range selector inner lever and park lock actuator (rod). (Note: If shaft does not slide out of case freely, use a file to deburr the shaft. **Do not hammer the shaft out and damage the bore.**)

STEP 11. Remove four extension housing bolts. Remove extension housing and discard O-ring. Remove and discard extension housing oil seal. Be careful not to damage bushing.

STEP 12. Remove output shaft yoke sleeve on models so equipped. (See Fig. 6) Depress speedometer driving gear clip and remove gear and clip. Put them in the oil pan.

STEP 13. Remove eight pump retaining bolts. (See Fig. 7) The two bolt holes at the 5 and 10 o'clock positions are tapped for

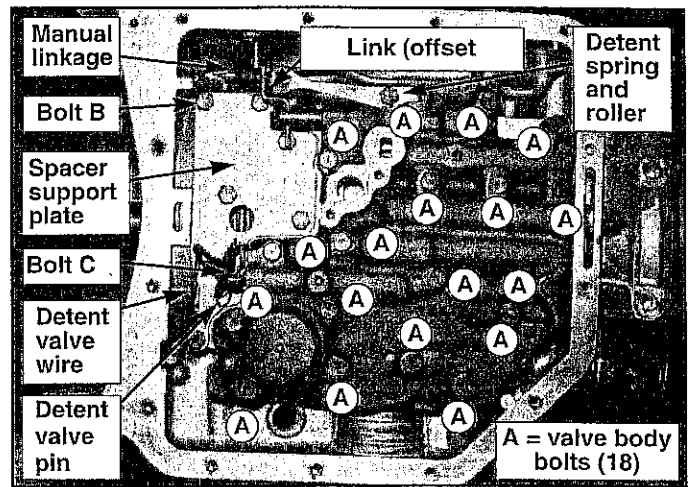

FIGURE 3

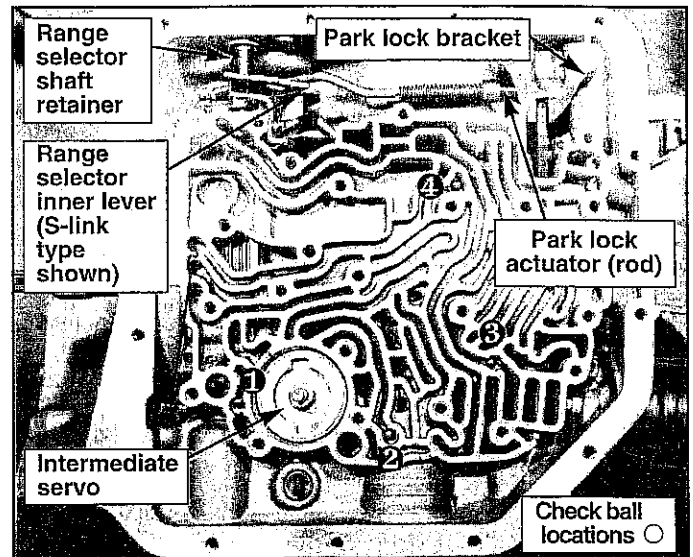

FIGURE 4

3/8-16 thread. Install slide hammers or a length of chain at these locations and "bump" the pump assembly out of the case. Remove and discard pump gasket and O-ring around the outside of the pump housing. Set the oil pump assembly aside.

STEP 14. Remove the wavy cushion spring from the case. (See Fig. 8) Remove two or three friction plates and steel plates. Remove the thick intermediate clutch pressure plate. Discard the friction plates and the steel plates. Put the wavy cushion spring and the thick pressure plate in the oil pan.

STEP 15. Remove the intermediate overrun brake band. (See Fig. 9) Use a screwdriver to unhook the anchor from the case and pull the band out of the case. Set it aside.



FIGURE 5

STEP 16. Grasp the input shaft and remove the entire clutch pack assembly. (See Fig. 9) There is a three-tab metal thrust washer between the clutch pack and the geartrain. Do not lose it. Set the clutch pack assembly aside.

STEP 17. Remove the input ring gear.

(See Fig. 10) This gear pulls straight out. Put the three-tab metal thrust washer on the front face of the ring gear in the oil pan. Set the ring gear aside. Remove the four-tab metal thrust washer from the front of the output planet carrier. Set it in the oil pan.

STEP 18. Remove the output planet carrier snap ring with a pair of snap ring pliers. (See Fig. 11) Remove the output planet carrier. Set the ring in the oil pan. Set the carrier aside.

STEP 19. Remove the sun gear/driving shell assembly. (See Fig. 12) Grasp the sun gear and pull the assembly out of the case. The four-tab sun gear drive shell thrust washer may be stuck to the back of the drive shell.

STEP 20. Remove the four-tab sun shell thrust washer from the front of the low and reverse roller clutch race if it did not come out with the drive shell. (See Fig. 13) Put it in the oil pan. Remove the low and reverse roller clutch support snap ring from the case. (See Fig. 13) Set it in the oil pan.

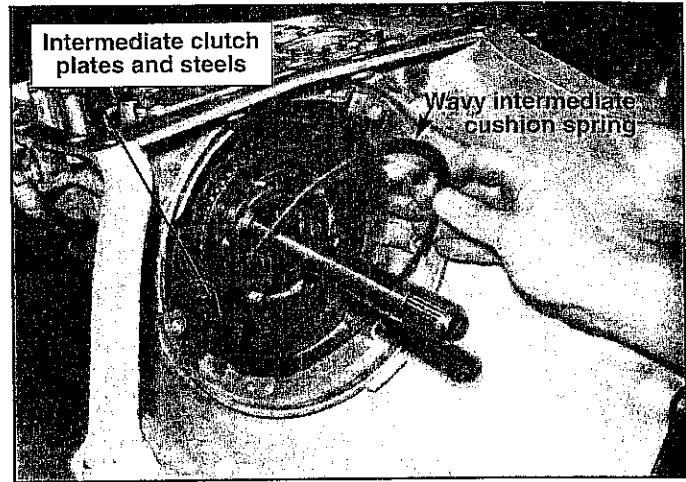

FIGURE 8

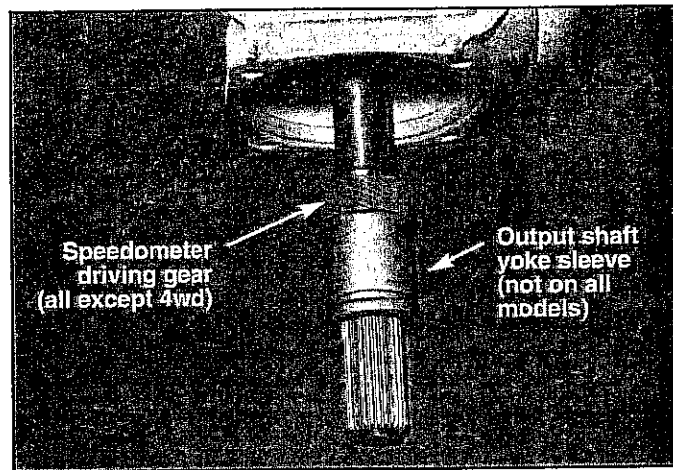

FIGURE 6

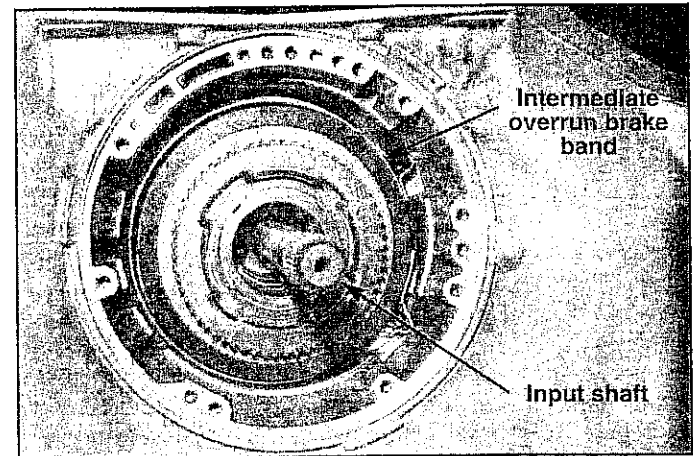

FIGURE 9

STEP 21. Remove the low and reverse roller clutch support assembly from the case. This may take a little effort but the assembly pulls straight out of the case. To help remove this assembly use a snap ring plier in an open lug, turn the low-reverse roller clutch support and at the same time push on the output shaft towards the front of the transmission. Inspect lugs in case, that held the low-reverse roller clutch support, for wear.

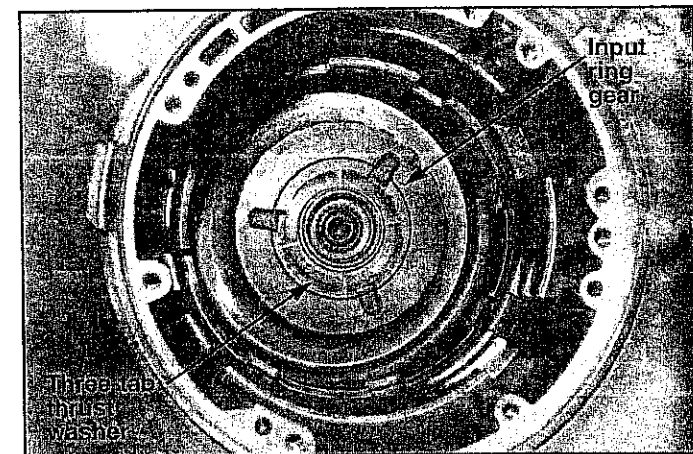

FIGURE 10

If the clutch support shows signs of seating into the case lugs deeper than .050" the case should be replaced.

STEP 22. Remove the race from the center of the roller clutch assembly. The race pulls right out. (See Fig. 14) Set the race in the oil pan. Remove the front snap ring from the roller clutch support. Remove the low and reverse clutch assembly from the support. Remove the rollers from the cage. Set the snap ring, roller and cage in the oil pan. Set the support aside.

STEP 23. Remove the clutch support retaining clip from the case. (See Fig. 15) This is a U-shaped clip near the side of the case. It probably fell out of position when the support was removed. Set the clip in the oil pan.

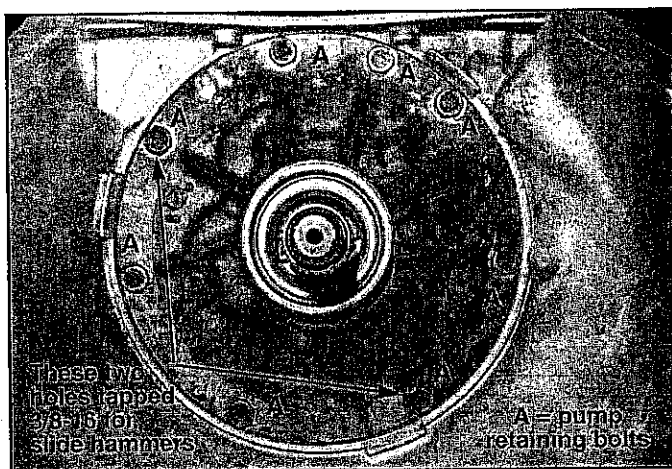

FIGURE 7

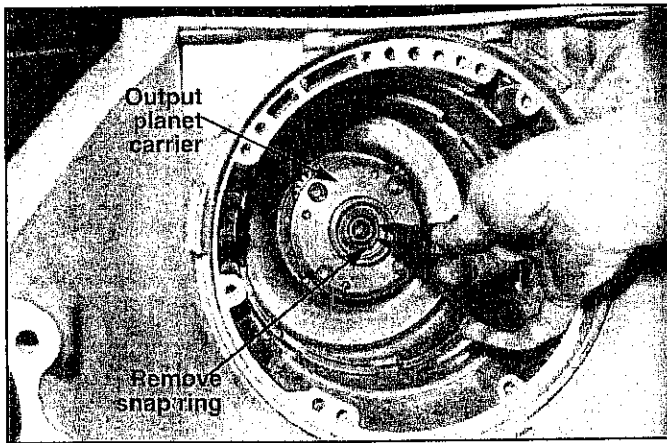

FIGURE 11

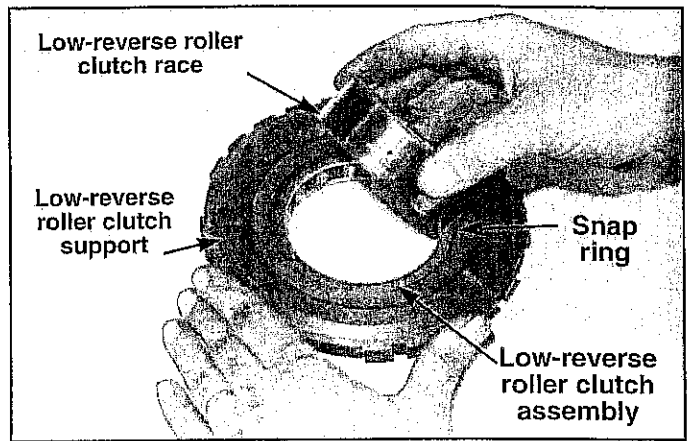

FIGURE 14

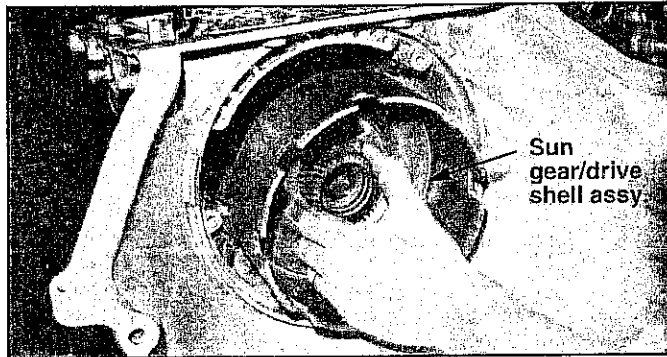

FIGURE 12

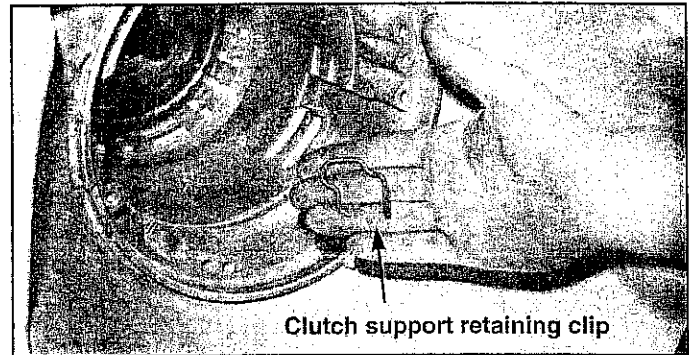

FIGURE 15

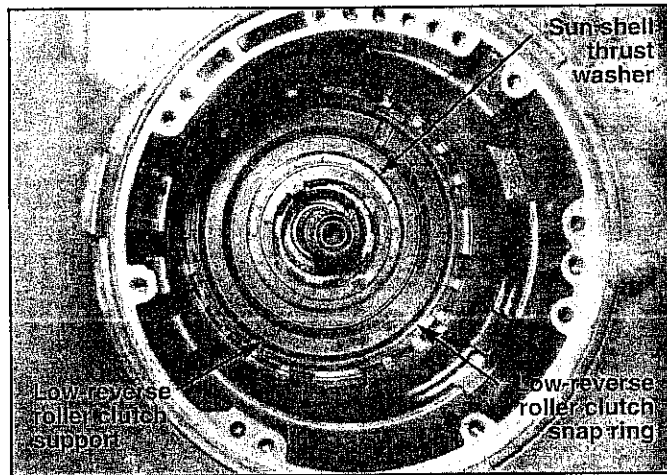

FIGURE 13

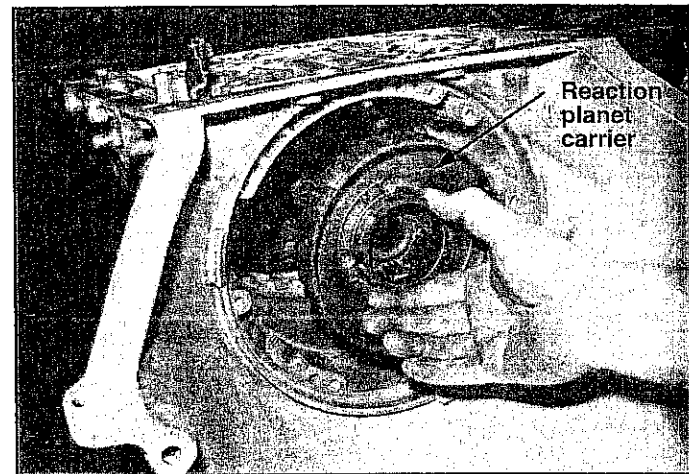

FIGURE 16

STEP 24. Remove the reaction planet carrier from the case by pulling straight out. (See Fig. 16) Set the carrier aside. Remove four or five low-reverse clutch plates and steel plates. (See Fig. 17) Set them aside.

STEP 25. Grasp the output shaft and remove the output shaft/output ring gear assembly. (See Fig. 18) It is not necessary to remove the output ring gear from the output shaft unless the shaft or gear need to be replaced.

STEP 26. Remove the three-tab output ring gear thrust washer. (See Fig. 18) It may be stuck to the back side of the reaction planet carrier. Set the washer in the oil pan. Set the shaft assembly aside. Remove the output ring gear bearing if it did not come out with the ring gear. (See Fig. 19) Set it in the oil pan.

STEP 27. Use a suitable tool to compress the low and reverse clutch piston spring retainer (Hayden Transtool #T-0151). (See Fig. 20) Remove the snap ring and slowly release the tool. Remove the retainer and seventeen piston return springs. Note

the color code of the springs. (Note: Some late model units have the springs attached to the retainer. Do not try to remove them from their staked position.) Set the snap ring, springs and retainer in the oil pan

STEP 28. Remove the low-reverse clutch piston. You can remove the piston with a pair of pliers if you are careful. If the piston is tight in the bore, apply air pressure to the reverse oil port in Figure 21 to pop the piston out of the case. Be careful when using air pressure not to splatter oil or injure yourself. Remove and discard the three rubber seals on the piston. Set piston aside.

STEP 29. Use an awl or small screwdriver to dislodge the accumulator snap ring. (See Fig. 22) Pry the snap ring out with a screwdriver. Remove the accumulator cover and O-ring, accumulator spring and accumulator piston. Discard the O-ring, accumulator spring, and metal seal rings on the accumulator piston. Do not remove Teflon seal rings. Set the cover, piston and snap ring in the oil pan.

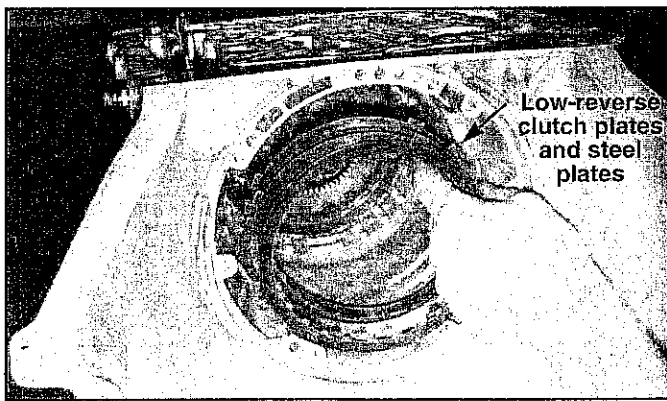

FIGURE 17

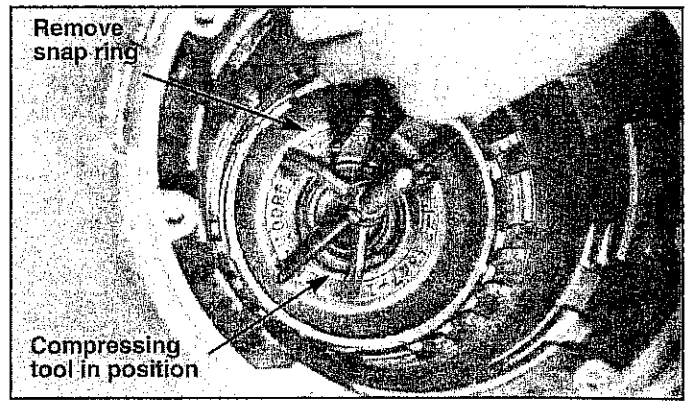

FIGURE 20

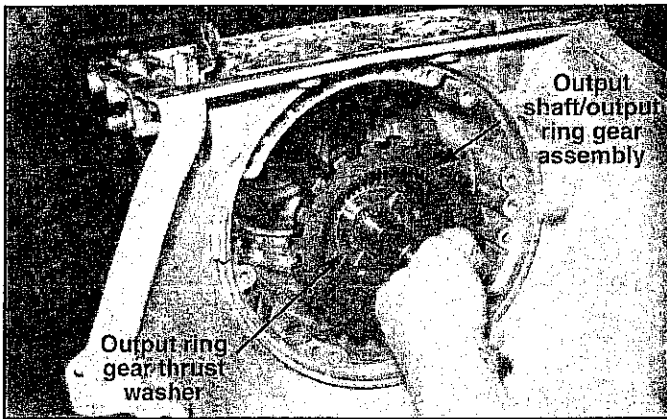

FIGURE 18

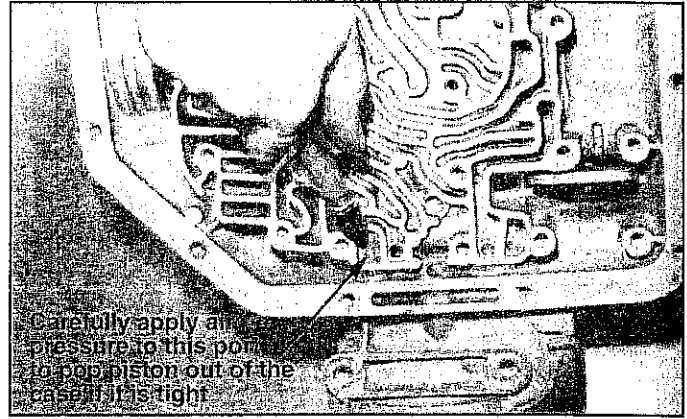

FIGURE 21

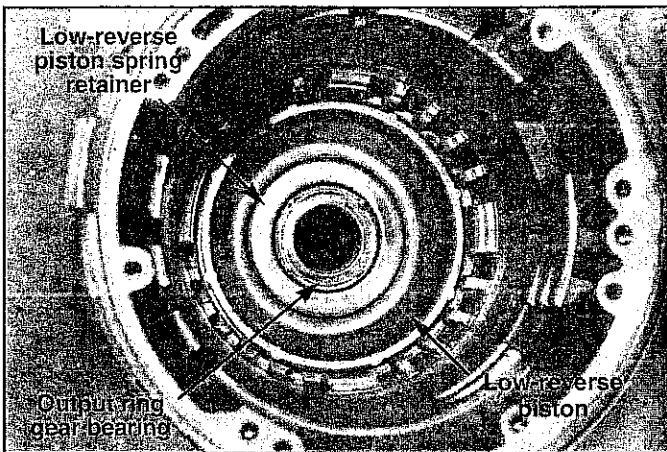

FIGURE 19

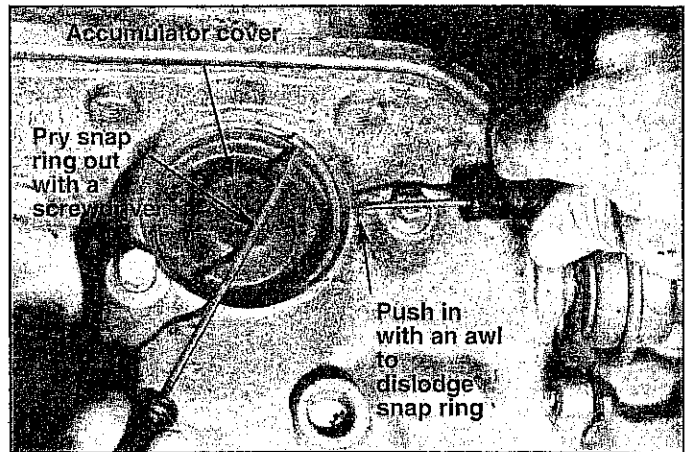

FIGURE 22

STEP 30. Remove and discard range selector shaft (shifter) oil seal. Remove oil cooler fittings from case. (See Fig. 1) Remove 1/8" pipe plugs from two or three locations. Remove smog control pressure switch, if equipped. The case is now stripped and ready to clean. The park pawl and spring do not have to be removed. When handling the case, be careful not to damage the valve body surface as this can cause erratic operation.

DISASSEMBLY OF SUB-UNITS

Section B

I. Oil Pump

STEP 1 Remove five oil pump bolts. (See Fig. 23) This will separate the pump body (front half) from the pump cover (rear half). Be careful when handling the pump not to damage pump surfaces or seal ring grooves.

STEP 2. Remove the rotors (gears) from the pump body. (See

Fig. 24) Some models will also have a pump priming valve and spring. Do not lose it. Remove the front seal being careful not to damage the bushing.

STEP 3. Remove and discard five metal hook-type or removable Teflon seal rings from the back of the cover. (See Fig. 25) Remove the selective metal thrust washer. Remove the intermediate clutch piston spring retainer and twenty or thirty piston return springs. Note the color code of the springs. (Note: Some late model units have the springs attached to the retainer. Do not try to remove them from their staked position.)

STEP 4. Remove the intermediate clutch piston from the pump cover. Remove and discard the rubber lip seals on the piston and set the piston aside. Keep all the pump parts together. The pump is now ready for cleaning.

II. Direct Clutch Assembly

STEP 1. Lift the direct clutch drum assembly off the forward

clutch drum. Remove the snap ring from the rear of the direct clutch drum. (See Fig. 26) Remove the direct clutch pressure plate. Remove and discard three to five clutch plates and steel plates. Remove and discard wavy cushion spring if your model is so equipped.

STEP 2. Place the drum in a press or use two C-clamps to compress the piston return springs and retainer. (See Fig. 27) Remove the retainer snap ring and relax tension on the retainer slowly. Another method is to reinstall the pressure plate and snap ring and use two flat blade screwdrivers. Place tips of screwdrivers under pressure plate on opposite sides and compress the springs. This will allow you to remove the snap ring with the snap ring pliers. This method may also be used for reassembly. Remove the retainer, seventeen return springs and direct clutch piston. Note the color code of the springs. (Note: Some late model units have the springs attached to the retainer. Do not try to remove them from their staked position.) Remove and discard two rubber lip seals from the piston and one rubber lip seal from the drum.

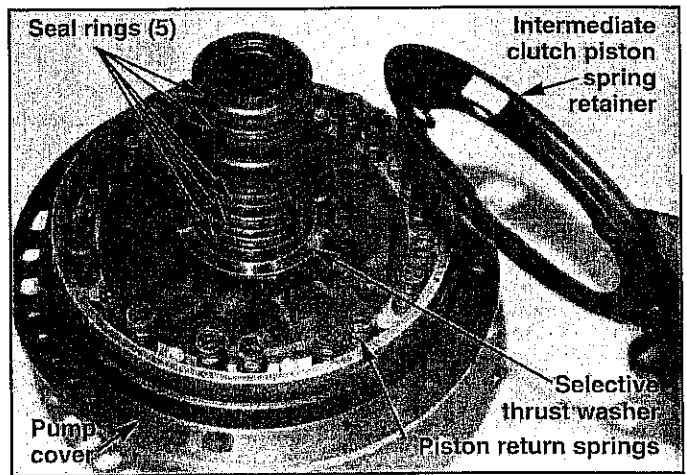

FIGURE 25

and discard four or five clutch plates and steel plates. Remove wavy cushion spring. Set the wavy cushion spring aside.

STEP 2. Place the drum in a press or use two C-clamps to compress the piston return springs and retainer. Remove the retainer snap ring and relax tension on the retainer slowly. Remove the retainer, twenty-one springs and forward clutch piston. Note the color code of the springs. (Note: Some late model units have the springs attached to the retainer. Do not remove them from their staked position.) Remove and discard two rubber lip seals from the piston. The forward clutch assembly is ready to clean.

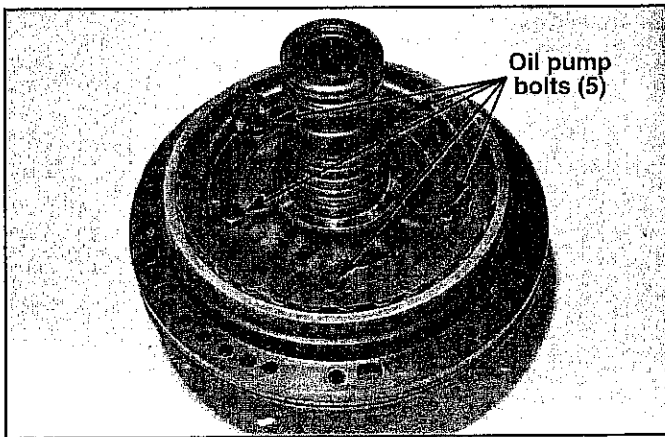

FIGURE 23

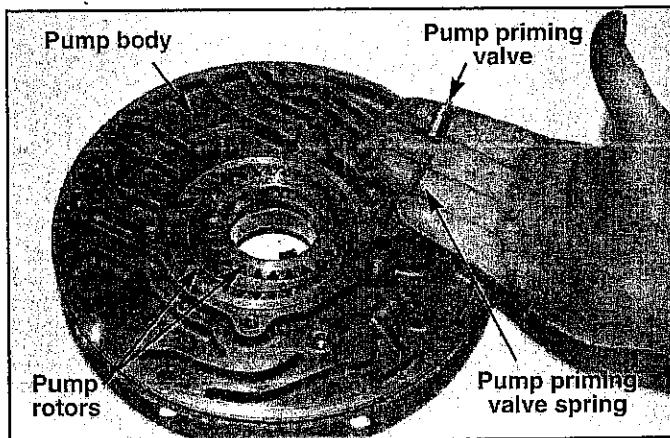

FIGURE 24

STEP 3. Turn the drum over and remove the intermediate overrun clutch snap ring and retainer. (See Fig 28) Remove the clutch outer race and overrun clutch by pulling straight off. The rollers may be removed from the cage for cleaning so they don't get lost. Do not mix these rollers with the rollers from the low and reverse overrun clutch. The direct clutch assembly is now ready to clean.

III. Forward Clutch Assembly

STEP 1. Remove the forward clutch drum to direct clutch drum needle bearing from the front of the forward clutch drum. Remove the snap ring from the rear of the forward clutch drum. (See Fig. 29) Remove the forward clutch pressure plate. Remove

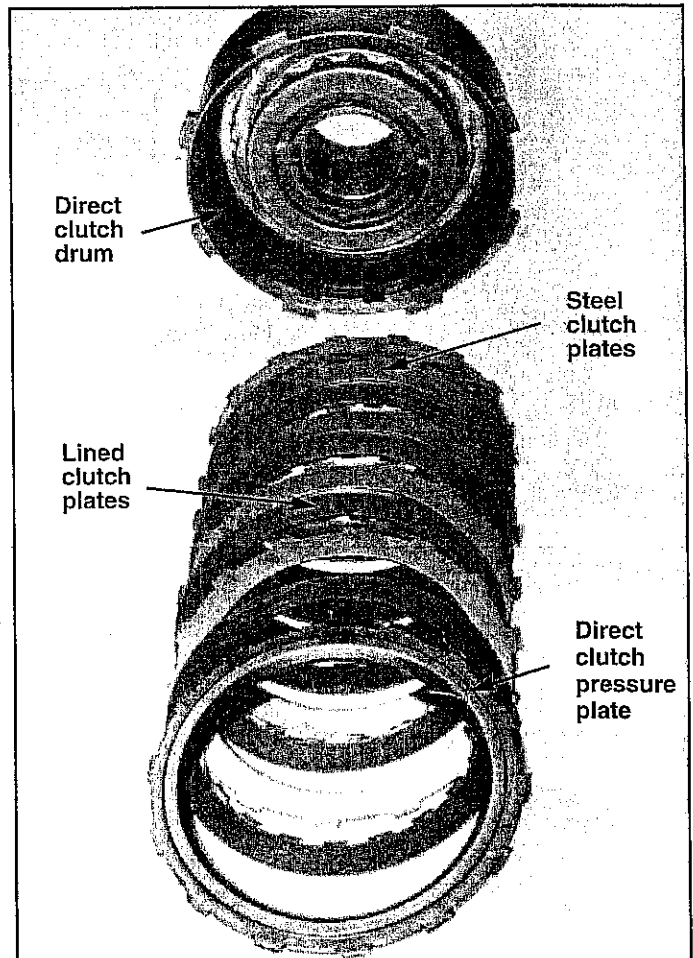

FIGURE 26

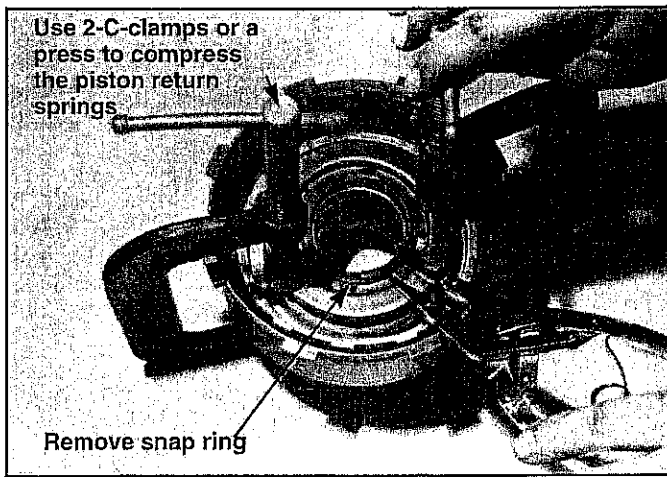

FIGURE 27

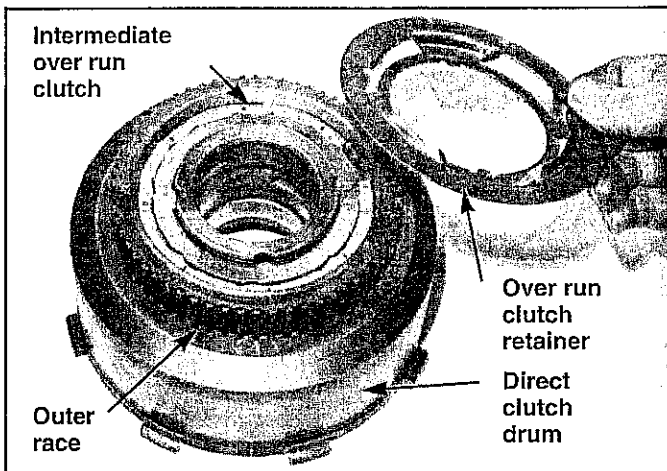

FIGURE 28

CLEANING

At this point it is time to clean the parts. You will clean the valve body during modification. If your transmission has no amount of visible hard residue or varnish, you can clean the parts satisfactorily in cleaning solvent. For varnished or excessively crusted parts, use a cold degreaser such as "Gunk." To prevent rusting, dip parts in solvent after washing "Gunk" off with water. Clean the following parts in solvent only: Vacuum modulator, governor, speedometer gears, kickdown cable and springs with color coding. Also clean any friction materials or bands in solvent only. Exercise care when handling parts not to nick or damage mating surfaces, ring grooves or machined areas. Do not wipe off internal parts with linty rags!

SUB-ASSEMBLY AND MODIFICATIONS

Section C

Note: There are several machining operations B&M does to the transmission to improve performance and life. Some of these operations require tools and/or machines not readily accessible to everyone. Any operations that are not absolutely necessary will be marked "optional" and can be performed if you so desire to get the most out of your transmission.

When performing modification and assembly steps it is important that you do not mix modifications from one level of performance to another (i.e. Heavy Duty in one step, and Street in another step). Also remember "Competition" modifications are not intended to be driven on the street. Shift point calibration is altered and shift points may be unacceptable for street use.

We suggest you have an oil can full of transmission fluid and a supply of grease (Vaseline, white grease, etc.) handy for pre-lubing during assembly.

It is strongly recommended that all bushings in the transmission be replaced even if they appear to be in good condition. Poor component support is one of the problems with the TH-350 design and new bushings improve transmission life.

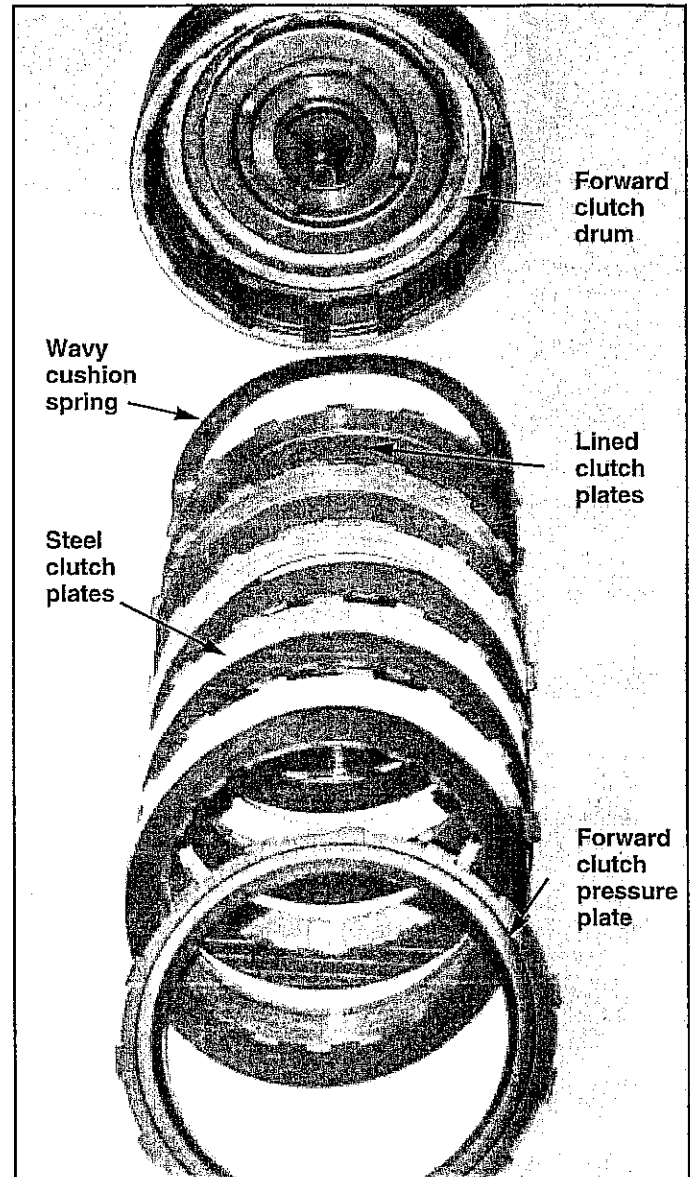

FIGURE 29

I. Valve Body

STEP 1. Place the valve body on the bench with the channel side up. Remove the roll pin holding the 2-3 shift control valve sleeve in place. (To remove the roll pin, push on the end of the sleeve until you notice the pin move slightly. Turn the valve body over and let the pin drop out of the valve body. If the pin doesn't drop out, rotate the sleeve as you push it in. You may need to tap the valve body on the bench lightly if the pin doesn't fall out. Be careful not to damage the sealing surface of the valve body if this step is necessary.) (See Fig. 30) Remove the sleeve carefully. This may require a little prying with a small screwdriver. Try not to raise any burrs during removal. Next remove the 2-3 shift valve spring. Discard this spring and replace it with the white spring supplied with the kit. Note: The small tapered end goes in first. Install the 2-3 shift control

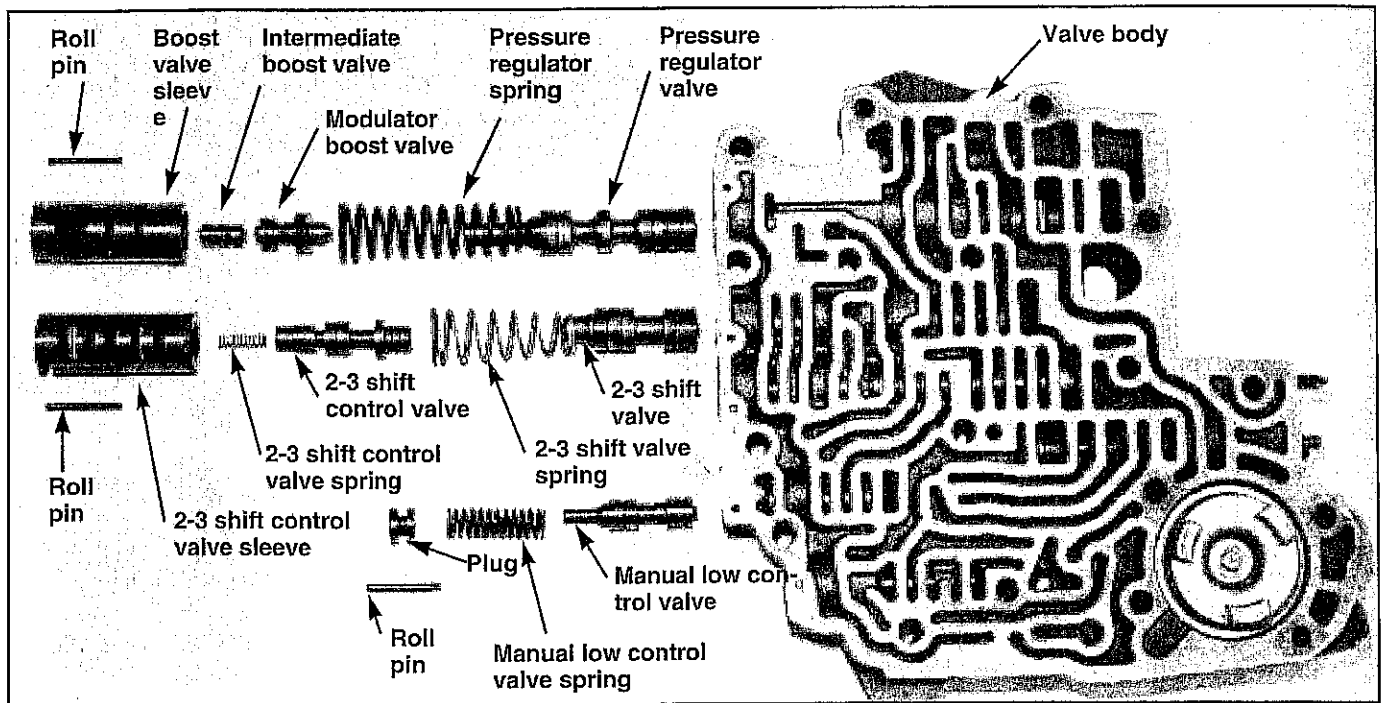

FIGURE 30

sleeve assembly as removed. Align sleeve and install retaining roll pin.

STEP 2. Remove the roll pin holding the boost valve sleeve in place. (See Fig. 30) Remove the sleeve carefully. Again, this may require a little prying with small screwdriver. Remove the pressure regulator spring and discard it. Replace it with the orange spring supplied with the kit. Note: The small tapered end goes in first. Replace sleeve assembly and roll pin.

STEP 3. Remove the roll pin that holds the manual low control valve plug in place. (See Fig. 30) Remove the plug and the manual low control spring. Discard the spring and install the special sleeve supplied in its place. Install the plug and pin as removed. (Note: If the sleeve is too long to allow the plug to install properly, grind a small amount off the end of the sleeve.)

STEP 4. 2-3 Accumulator.

Heavy Duty and Street: No modification is necessary for this application.

Competition: Carefully clamp the valve body in a vise or C-clamp to compress the accumulator spring. (See Fig. 31) Compress the piston just enough to remove the E-clip. Remove the valve body from the vise and remove the piston and spring. Discard the spring and install the accumulator piston as removed. Install E-clip as removed. Be careful not to damage sealing ring during installation.

STEP 5. Scrape off any excess gasket material that may be stuck to the casting surface. This is very important as stray gasket material can cause leaks. Wash valve body in solvent to remove residue. Be careful not to lose the roll pins that hold sleeves in place.

STEP 6. Clamp the spacer support plate in a vise and run a file across the surface that will contact the separator plate. (See Fig. 32) You want the spacer support plate to be flat. If your plate is bent or excessively warped, it should be replaced. (Chevrolet Part No. 338905)

II. Oil Pump

STEP 1. Inspect oil pump body for damage. The area where the pump rotors ride should have no excessive wear. (See Fig.

33) Some scratch marks are normal. The rotor face of the pump cover should have no step at any point where rotors ride. (See Fig. 34) The rotors themselves should have clean faces and the outer edge of large rotor should show no metal transfer or wear.

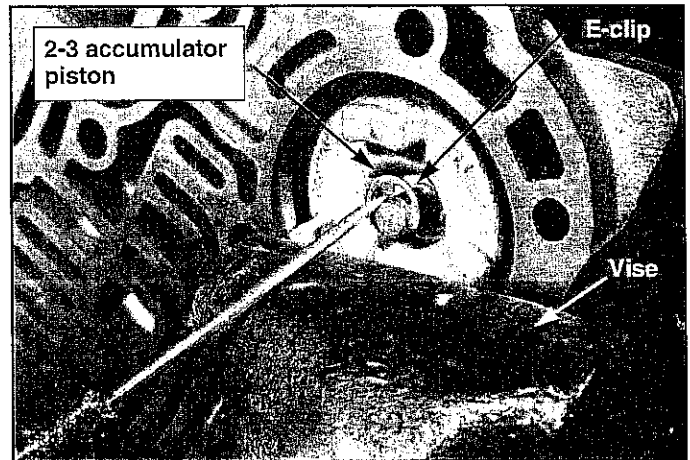

FIGURE 31

STEP 2. Use a large flat fine-tooth file to remove any high spots on the face of the body and cover. (See Fig. 33 and 34) Clean the pump halves in solvent to remove any metal particles. Lay the mating surface of the pump body on the upright cover and run a 0.003 inch feeler gage around the edge. (See Fig. 36) The gage should not find any gaps greater than 0.003 inch. If the mating surfaces vary excessively check for burrs, nicks or high spots which may be causing the problem. Excessive warpage indicates the pump will have to be replaced.

STEP 3. Inspect the following areas:

Pump Bushing: Replace as necessary.

Seal Ring Grooves: Install the correct sealing ring on each ring groove and make sure it spins freely. Remove any interference with a small flat file.

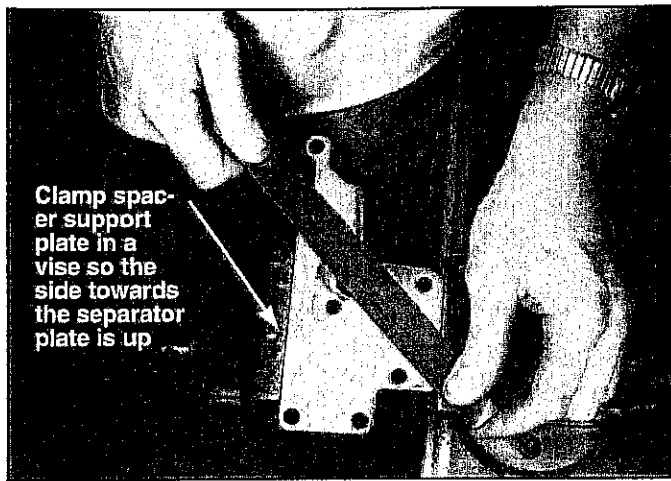

FIGURE 32

Stator Shaft Bushings: Replace as necessary.

Direct Clutch Drum Bushing Surface: Diameter must be smooth with no wear or contact from drum "wobble."

STEP 4. Install new front pump seal in body. Check the fit of the rotors in the pump body. The rotors should slip in easily into the body with a close fit and rotate freely. Any interference from burrs or nicks can be removed with a stone. Be sure to reclean parts after you file or grind on them.

STEP 5. Lubricate pump body and rotors with transmission fluid and install the rotors into the pump body. The tangs or drive lugs on the inner rotor must be offset to the rear of the pump (away from the pump seal.) Installing the rotors backwards will

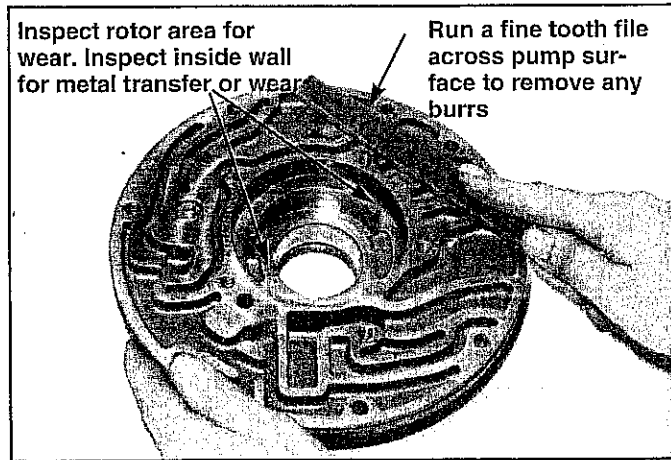

FIGURE 33

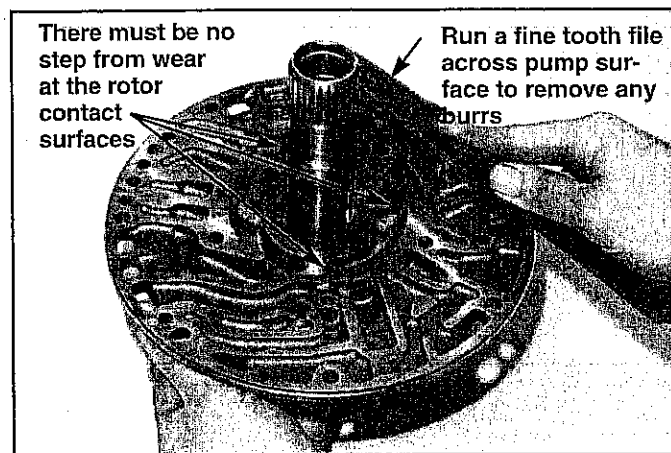

FIGURE 34

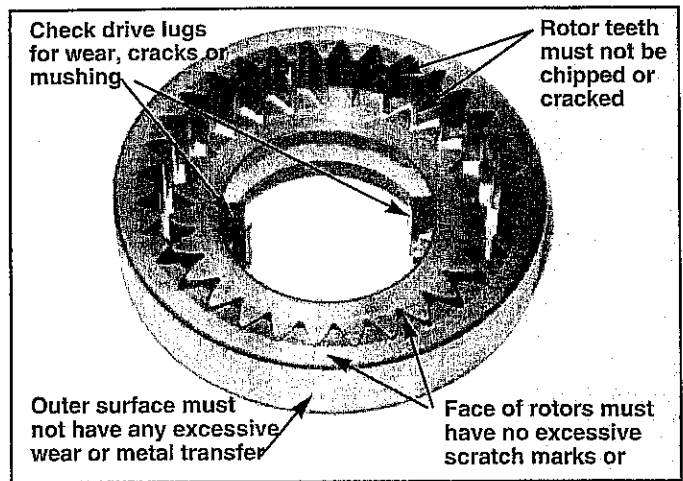

FIGURE 35

damage pump, transmission and converter. Install pump priming valve and spring on models so equipped. (See Fig. 24)

OPTIONAL: On units originally equipped with less than three intermediate clutch plates, three clutch plates and steel plates can be installed by machining the intermediate clutch piston as shown in Drawing 1.

STEP 6. Install new rubber lip seals from the kit in place on the intermediate clutch piston. Lubricate the lip seals with automatic transmission fluid and install piston into the pump cover using a 0.010 feeler gage to guide the seals into place. (See Fig. 37) Be careful not to nick or cut the seal or fold the edge. If the piston is properly installed, it will turn in the bore with the piston all the way down.

STEP 7. Install twenty return springs only, leaving every third location empty. Discard extra intermediate piston springs. Install spring retainer in position and align bolt holes.

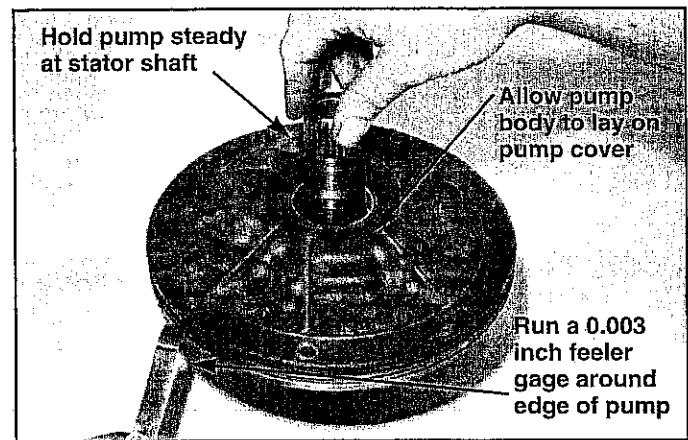
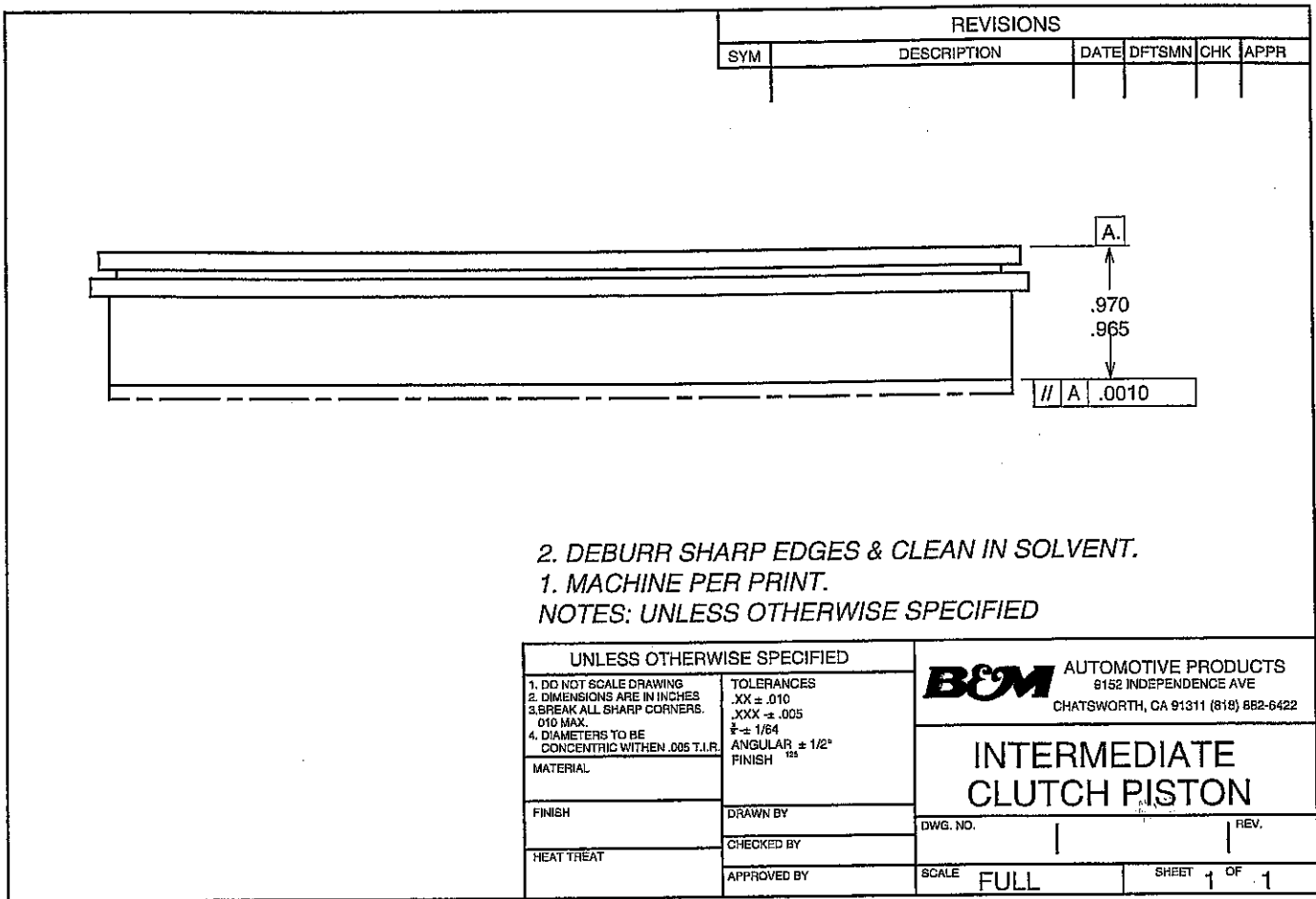

FIGURE 36

STEP 8. Position the pump cover over the pump body. Align the outer bolt holes and hold the pump halves together while installing the five pump bolts finger tight. Be careful not to use the longer valve body bolts in the pump. The outer edges of the pump must be aligned properly. This can be done by setting the pump into the transmission case face down, and aligning the outer bolt holes with a screwdriver (See Fig. 38) Do not install an O-ring on the outside diameter of the pump during this operation. Tighten pump bolts 18 to 20 lb. ft.

STEP 9. Remove the pump from the case and set it carefully over the neck of the torque converter. Rotate the entire pump assembly on the converter. It should rotate freely with a slight



DRAWING 1

even resistance. Any bind or tightness indicates dirt, burrs or warpage interfering with the rotors. The pump will have to be disassembled and the problem corrected. An incorrectly assembled pump will fail immediately! Set the pump aside where it won't get dirty.

III. Forward Clutch (Refer to Figure 29)

STEP 1. Inspect the seal ring bore on the front of the clutch housing for wear or grooves. Inspect the clutch splines on the front of the drum for wear or grooves. Excessive grooving will require housing replacement as the wear could fail the seal rings prematurely or lead to clutch spline failure from clutch load. Inspect the thrust washer surface on the back face of the drum for wear.

STEP 2. Inspect all bushing diameters on the input shaft. Pay



FIGURE 37

particular attention to the small diameter at the rear of the input shaft as this is a weak spot. Any wear of bushing surfaces indicates that shaft will have to be replaced.

OPTIONAL: Models with only four forward clutch plates can be increased to five plates by machining the forward clutch piston as shown in Drawing 2. Extra friction discs and steel plates can be purchased from your GM dealer. This is a non-shifting clutch so stock friction discs are sufficient.

STEP 3. Install new rubber lip seals in place on forward clutch

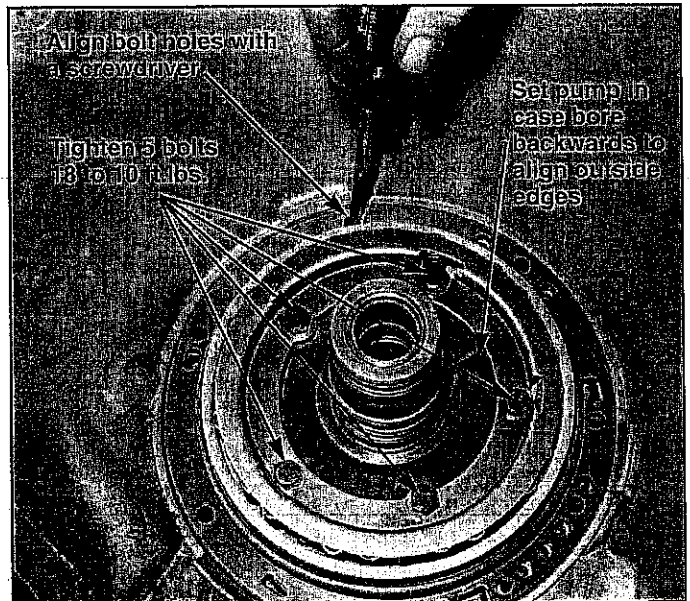
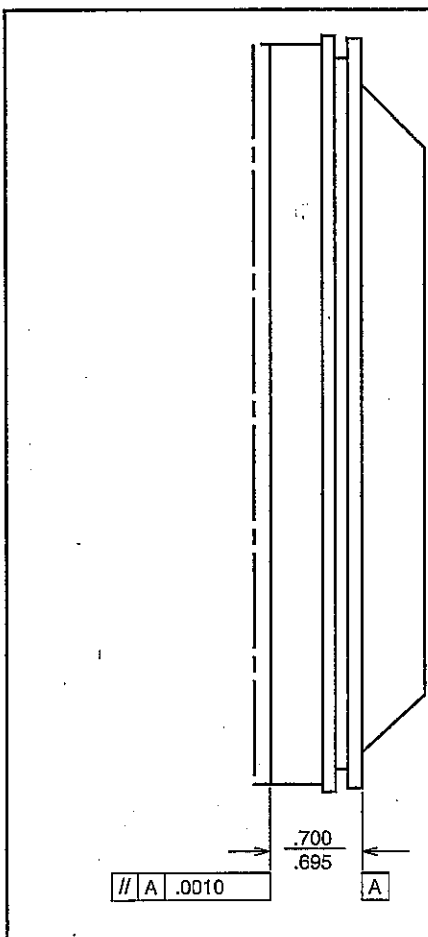

FIGURE 38



REVISIONS					
SYM	DESCRIPTION	DATE	DFTSMN	CHK	APPR

2. DEBURR SHARP EDGES & CLEAN IN SOLVENT.
 1. MACHINE PER PRINT.
 NOTES: UNLESS OTHERWISE SPECIFIED

UNLESS OTHERWISE SPECIFIED		B&M AUTOMOTIVE PRODUCTS 9152 INDEPENDENCE AVE CHATSWORTH, CA 91311 (818) 882-6422
1. DO NOT SCALE DRAWING 2. DIMENSIONS ARE IN INCHES 3. BREAK ALL SHARP CORNERS. .010 MAX. 4. DIAMETERS TO BE CONCENTRIC WITHIN .005 T.I.R.	TOLERANCES .XX ± .010 .XXX ± .005 $\frac{1}{2}$ ± 1/64 ANGULAR ± 1/2° FINISH ¹⁵	
MATERIAL	FINISH	FORWARD CLUTCH PISTON DWG. NO. 2 REV. 1
HEAT TREAT	APPROVED BY	

DRAWING 2

piston. Lubricate the seals lightly with automatic transmission fluid. Install the piston into the clutch housing using a 0.010 feeler gage to guide the seals into place. Be careful not to nick or cut the seal or fold the edge. If the piston is properly installed, it will turn in the bore with the piston all the way down.

STEP 4. Install twenty-one return springs in their pockets. Install return spring retainer. Refer to the snap ring chart and select the retainer snap ring. Compress the retainer and springs using a press or C-clamp. Be careful not to bend or distort the retainer. Install snap ring making sure it is seated in its groove. Release the retainer so it stops against the snap ring.

STEP 5. Soak the B&M friction plates in automatic transmission fluid for 15 minutes. Install single wavy cushion spring against piston. Install alternately four or five steel plates and friction discs starting with a steel plate and ending with a friction disc.

STEP 6. Install forward clutch pressure plate in drum. Install forward clutch snap ring. Insert a feeler gage between the pressure plate and the last friction disc to check clutch clearance. Clearance must be between 0.015-0.030 inch. Different thickness pressure plates are available from your GM dealer to adjust clearance.

STEP 7. Set the forward clutch assembly on the bench with the input shaft pointing up. Install the direct clutch drum to forward clutch housing bearing in position with the I.D. flange facing up. Set the forward clutch assembly aside.

IV. Direct Clutch (Refer to Figure 26)

STEP 1. Inspect the seal ring bore on the front of the direct clutch drum for wear or grooves. Any grooving will require housing replacement as the wear could fail the seal rings prematurely. Inspect the intermediate sprag race (cam) on the front of the drum. If the race is worn, pitted, or has chatter

marks, the drum will have to be replaced.

OPTIONAL: Models with only three or four direct clutch plates can be increased to five plates by machining the direct clutch piston as shown in Drawing 3. The extra clutches will provide increased torque capacity.

STEP 2. Install inner and outer direct clutch piston seals in place on the direct clutch drum with the middle rubber lip seal in place on the direct clutch drum with the edge of the lip facing out.

STEP 3. Lubricate the seals lightly with automatic transmission fluid. Install the piston into the clutch drum using a 0.010 feeler gage to guide the seals in place. Be careful not to nick or cut

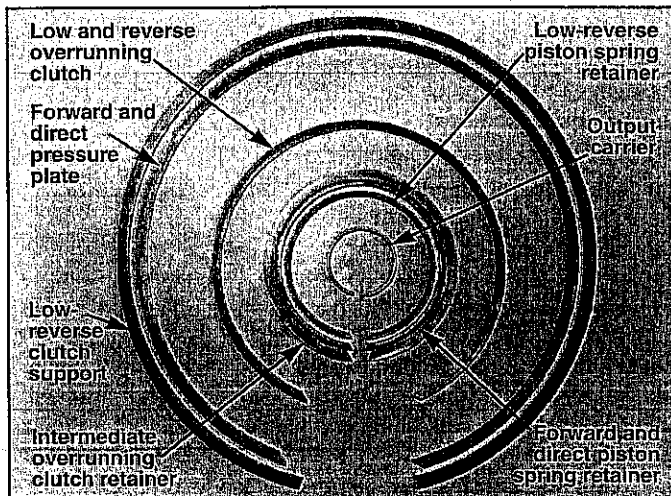

SNAP RING CHART

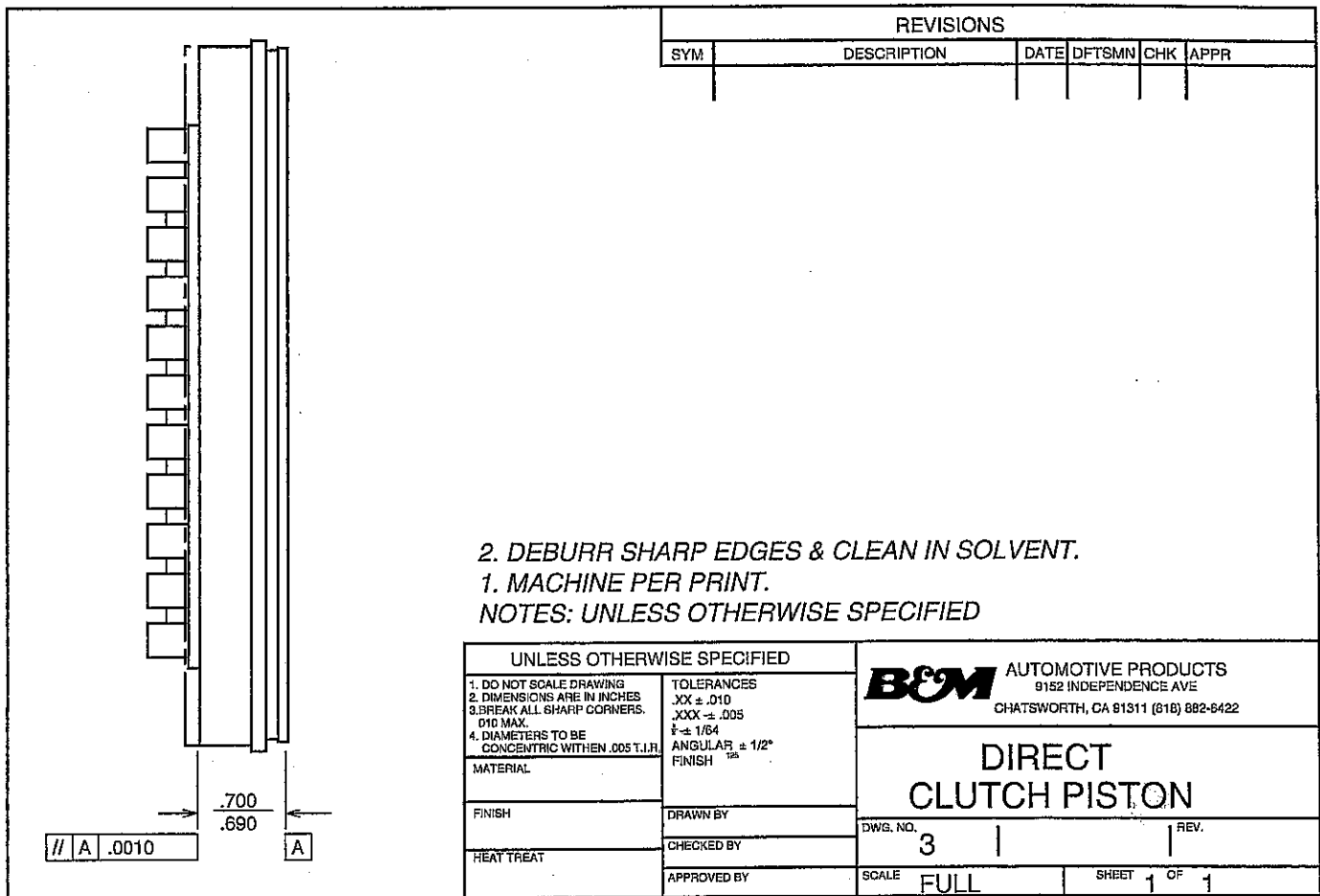

DRAWING 3

the seal or fold the edge. If the piston is properly installed it will turn in the bore with the piston all the way down.

STEP 4. Install sixteen return springs in their pockets. Install return spring retainer. Refer to the snap ring chart and select the retainer snap ring. Compress the retainer and springs using a press or C-clamps. Be careful not to bend or distort the retainer. Install the snap ring. Do not expand the snap ring any more than necessary. Make sure the snap ring is completely seated in the groove. Release the retainer so it stops against the snap ring.

STEP 5. Soak the B&M direct clutch plates supplied with the kit in automatic transmission fluid for 15 minutes. Install alternately three to five steel plates supplied and three to five B&M friction discs starting with a steel plate, and ending with a friction disc. Do not install a wavy cushion spring. Install the direct clutch backing plate and snap ring.

STEP 6. Use feeler gages to measure the clearance between the last friction disc and the backing plate. The clearance must be between 0.060-0.080 inch. The clearance can be adjusted by different thickness pressure plates available from your GM dealer (to install 5 frictions into the direct drum, a forward clutch pressure plate may be needed [GM P/N 6261072]). It may be necessary to install one extra steel plate to make up for the wavy cushion plate, if you are using only three or four friction discs.

STEP 7. Turn the direct clutch housing over and install the intermediate overrunning clutch. Install eight rollers in the bushing cage. Install roller/cage assembly onto direct clutch drum. Install outer race, rotating the race counter clockwise while holding the direct clutch drum. Install the sprag retainer and snap ring. Make sure the snap ring is fully seated in its groove.

STEP 8. Install the direct clutch assembly onto the forward clutch assembly from Section C, Part III, Step 7. Rotate the drum as necessary to engage the clutches. When fully engaged and in position, the drum should sit level and spin freely. Set the clutch assembly aside.

V. Case Preparation and Assembly

Run a large flat file across the valve body face of the case to remove any burrs or high spots. Be careful not to create any deep scratches in the surface. (See Fig. 39)

STEP 1. Install the modulator valve into the case. (See Fig. 40) The valve should move freely with no bind. If any sticking is encountered deburr the valve with a stone and work the valve in and out carefully until it frees up. Remove the valve and blow out the bore in the case to remove dirt. Install modulator valve.

STEP 2.

Heavy Duty and Street: Install new vacuum modulator O-ring in position on modulator and install modulator into case. The last 1/8" travel will be spring loaded.

Competition: Install new vacuum modulator O-ring in position on special modulator plug supplied with the kit. Install plug into case.

Install modulator retaining clamp & bolt. Tighten bolt to 10 lb. ft.

OPTIONAL: Models with only four low-reverse clutch plates can be increased to five plates by machining the low-reverse clutch piston as shown in Drawing 4. Extra friction discs and steel plates can be purchased from your GM dealer. The extra clutches will provide increased torque capacity.

STEP 3. Install three square cut seals in place on low-reverse clutch piston. Lubricate the seals with automatic transmission

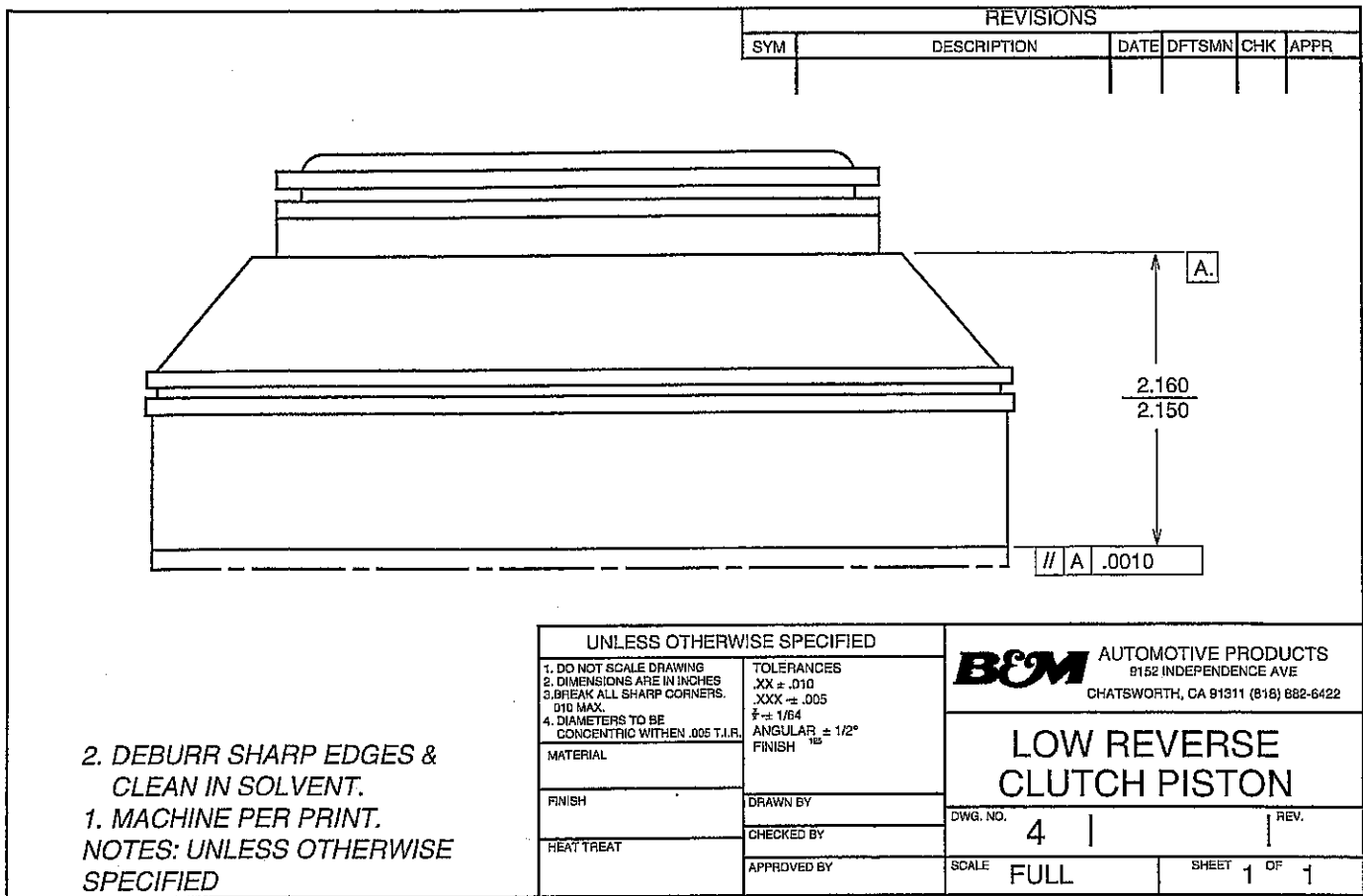

DRAWING 4

fluid and install the piston into the case. Note: There is a relief in the case that must align with a guide on the back of the low-reverse clutch piston. (See Fig. 41) This will position the piston to clear the park pawl. Seat the piston firmly in the case by tapping it down with a hammer handle.

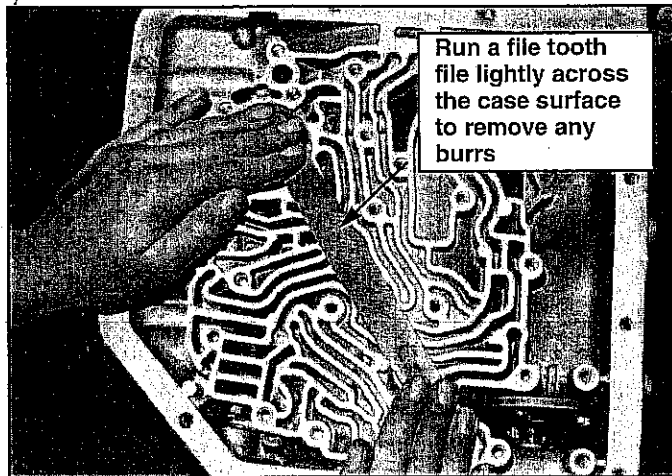

FIGURE 39

STEP 4. Install seventeen return springs in their pockets. Install return spring retainer. Refer to the snap ring chart and select the retainer snap ring. Compress the retainer and springs using a suitable tool. Be careful not to bend or distort the retainer. Install snap ring, making sure it is seated in its groove. Release the retainer so it stops against the snap ring.

STEP 5. Inspect bushing diameter of output ring gear for wear and grooving. (See Fig. 42) Replace as necessary. Inspect

bushing diameters and small bushing at front of output shaft. (See Fig. 43) Worn shafts must be replaced. Worn bushing must be replaced.

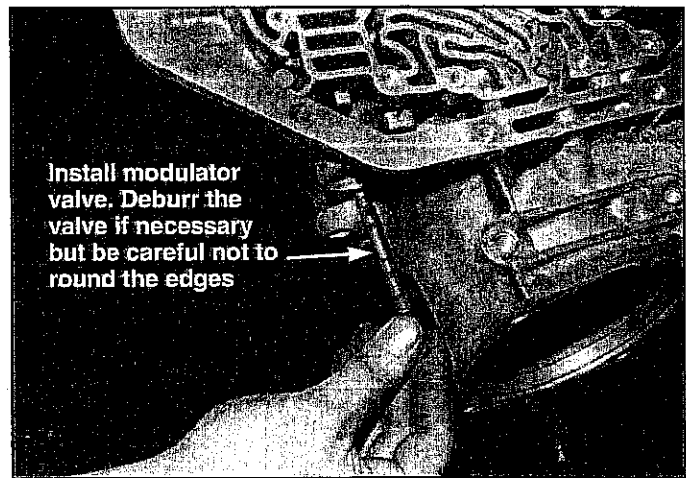

FIGURE 40

STEP 6. Support the case so it is off the ground to provide clearance for the output shaft. Install output needle bearing in place at the rear of the case with I.D. flange down. Install output shaft/output ring gear assembly into case. Output shaft must rotate freely. Install three prong thrust washer in place on front face of output ring gear. (See Fig. 18) Lubricate washer with automatic transmission fluid.

STEP 7.

Inspect reaction planet carrier:
Splines on outside diameter for wear.

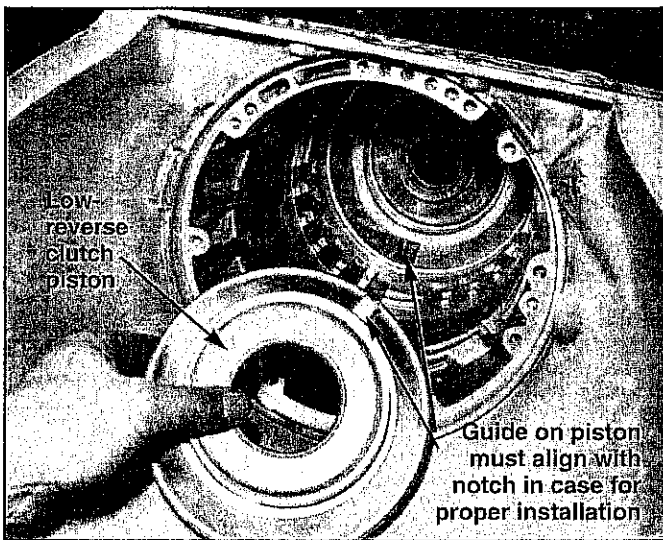

FIGURE 41

Thrust surface on rear face for wear.

Check pinions for damage, rough bearings or excessive tilt. Pinion end play should be 0.009"-0.024".

Install the reaction planet carrier. (See Fig. 16) Lubricate bushing and pinion gears before assembly. Carrier should rotate freely in both directions. Binding indicates bad or dirty pinion gears.

STEP 8. Soak the B&M low-reverse friction plates in automatic transmission fluid for 15 minutes. Install four or five friction discs and steel plates alternately starting with a steel plate and ending with a friction disc. (See Fig. 44)

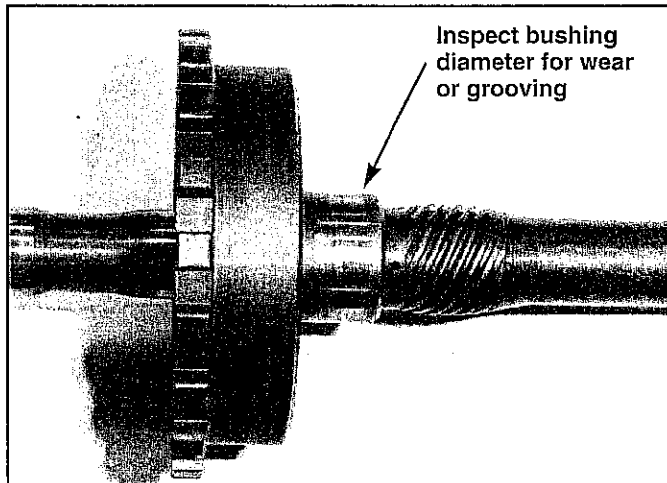

FIGURE 42

STEP 9. Install the clutch support retaining spring (clip) into place. (See Fig. 45) If the case is propped up slightly the clip will stay in place. Grease may be used to retain it also.

STEP 10.

- Inspect the low-reverse overrunning clutch assembly.
- Inspect rollers for wear or flat spots.
- Inspect accordion springs for distortion.
- Inspect inner face for wear or pitting.
- Inspect clutch support for wear at outer face and rear face.

STEP 11. Install rollers into cage from the outside to avoid bending springs. Install cage assembly into clutch support with four lube holes (0.091) on cage end towards rear. (See Fig. 46) Install retaining snap ring. Make sure snap ring is fully seated in its groove.

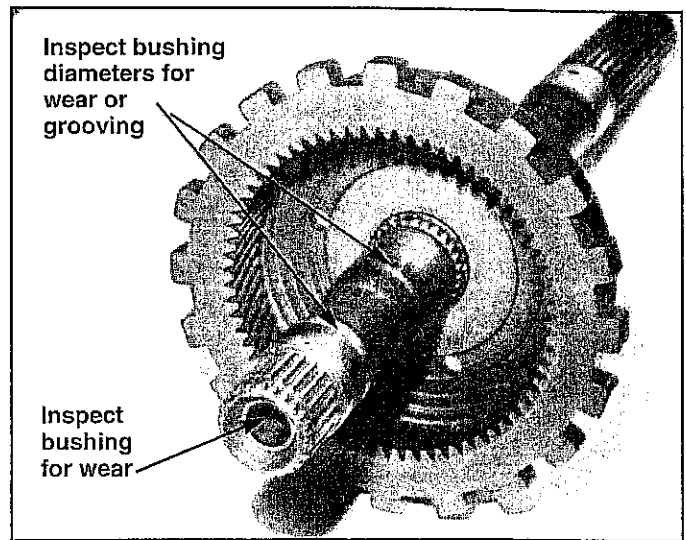

FIGURE 43

STEP 12. Guide clutch support into case, aligning splines properly. (See Fig. 47) Push down on support so it engages retaining spring (clip) and seats firmly against case. Select clutch support snap ring. Install snap ring into case. The ends of the snap ring must line up on either side of the retaining clip to clear it. Make sure the snap ring is fully seated in its groove.

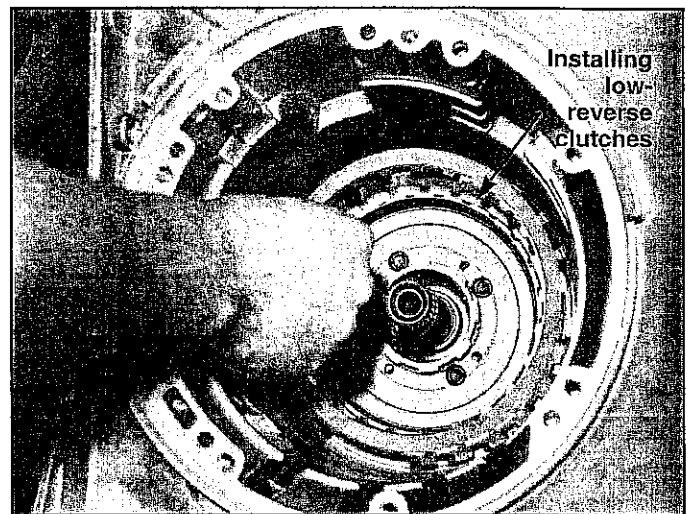

FIGURE 44

STEP 13. Install the low-reverse roller clutch inner race. Position the race in the clutch support. Make sure all rollers are in position first. Push in on the race and rotate it clockwise at the same time to engage rollers. Continue to push in on the race and rotate it until it engages the reaction planet carrier. If the roller clutch is properly installed, the race will only be able to turn clockwise. If the race can turn both ways the roller clutch cage is in upside down and the transmission will not work in "Drive."

STEP 14. Install the four-tab sun shell thrust washer in place on the front of the low-reverse roller clutch inner race. (See Fig. 13) Use grease to retain it if necessary. Lubricate the washer with automatic transmission fluid.

STEP 15. Inspect sun gear/drive shell assembly:

- Check gears for pitting or wear.
- Check drive shell for damage or distortion.

Lubricate sun gear bushings with automatic transmission fluid and install sun gear/drive shell into transmission. The drive shell should turn freely in both directions.

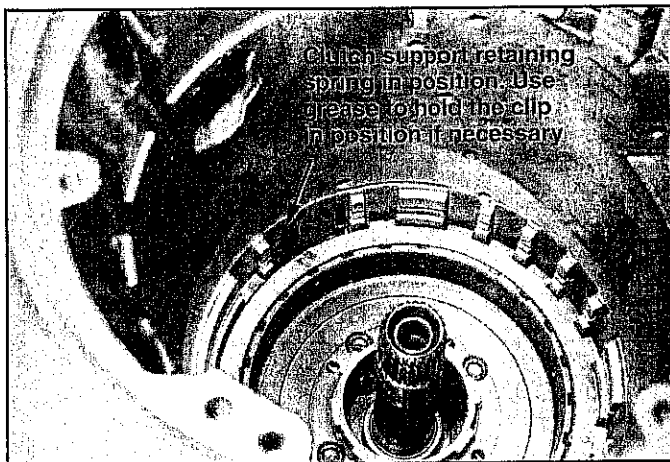

FIGURE 45

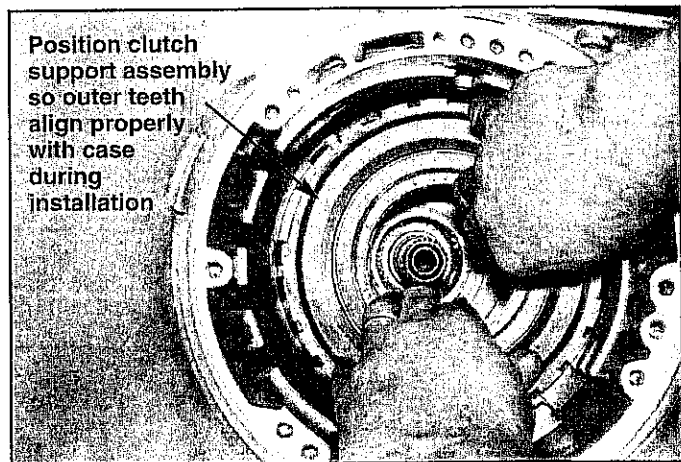

FIGURE 47

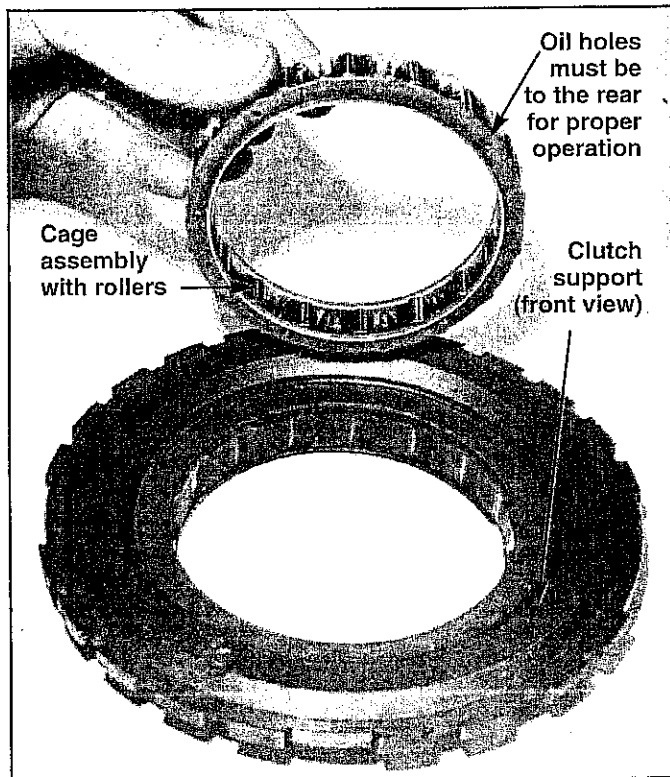

FIGURE 46

STEP 16. Inspect the output carrier:

- Splines on the inside diameter for wear.
- Bushing diameter on front face.
- Check pinions for damage, rough bearings, or excessive tilt.
- Pinion end play should be 0.009"-0.024."

Install the output carrier. Push down until it seats firmly against the sun gear. Install the snap ring in position on the output shaft. Make sure the snap ring is fully seated in its groove. Install four-tab thrust washer in place on front face of output carrier. (See Fig. 48) Use grease to hold washer in place. Lubricate the washer with automatic transmission fluid.

STEP 17. Inspect the input ring gear assembly:

- Check gear teeth for pitting or wear.
- Check splines on the outside diameter for wear.
- Check thrust washer surface on rear face for wear.

Install the input ring gear. Rotate as necessary until the gear seats against the carrier. The input ring gear should rotate smoothly in both directions with more resistance in the counter

clockwise direction. Install the three-tab input ring gear thrust washer in place on the front of the ring gear. (See Fig. 10) Use grease to retain it if necessary. Lubricate the washer with automatic transmission fluid.

STEP 18. Install the clutch pack assembly into the transmission. (See Fig 49) Pick the assembly up by the input shaft and lower it into the transmission. Do not stand the transmission on the output shaft. Rotate clutch pack assembly to engage forward clutches into input ring gear. You will be able to count the clutches as they engage the input ring gear. The ears of the direct clutch drum must engage the drive shell slots.

STEP 19. Install the B&M intermediate overrun brake band. Use a screwdriver to engage the anchor into the boss in the case. (See Fig. 50) Insert a thin screwdriver through the servo rod hole in the case and work the band to seat it.

STEP 20. Install pump gasket in position on front face of case. Install selective thrust washer in place on the back of pump. Make sure tab on washer aligns with notch in pump cover. Use a small amount of grease to hold it in place. Align pump and install in position. Install one pump bolt finger tight.

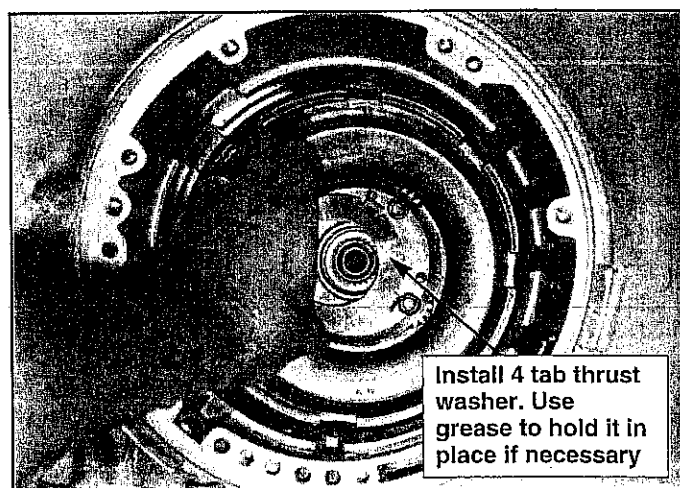

FIGURE 48

STEP 21.

- Check end play of input shaft.
- A dial indicator on the end of the input shaft is the most accurate method.

The output shaft must not be loaded forward for this measurement. You are measuring the clearance between the front of the direct clutch drum and the selective thrust washer on the

back of the pump. End play should be between 0.015-0.030. Different thickness thrust washers are available from your GM dealer. If there is no end play a thrust washer is out of place or a clutch is not engaged.

STEP 22. When end play is properly adjusted remove the pump and gasket from the transmission.

Install the thick intermediate clutch pressure plate into the transmission with the flat face out. (See Fig. 51) The splines are keyed so the plate can only install one way.

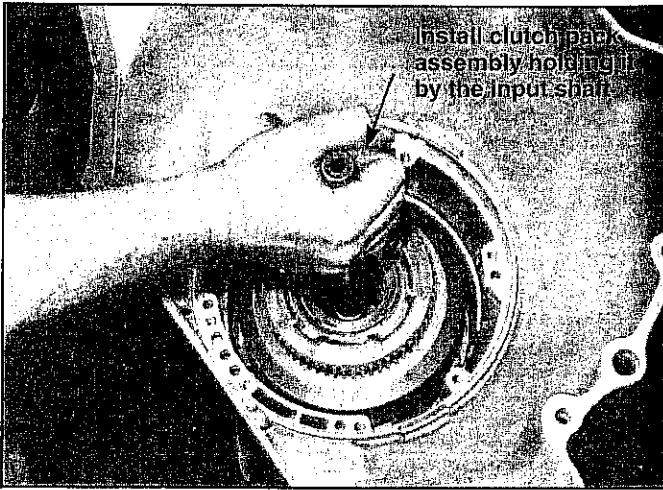

FIGURE 49

Install the pump into the transmission. Align pump with guide pins and seat the pump against the case.

STEP 26. You should be able to push the pump assembly into the case using your hands and your weight. An alternate method is to install two pump bolts in opposite holes. Carefully draw each bolt down two turns at a time until the pump seats. Make sure the input shaft rotates freely. If it does not, a thrust washer is out of place or you did not fully engage a clutch. Remove the pump and check for the problem. Remove the two bolts and guide pins. Install sealing washer onto each pump bolt as required. Install eight pump bolts and tighten 18 to 20 lb. ft.

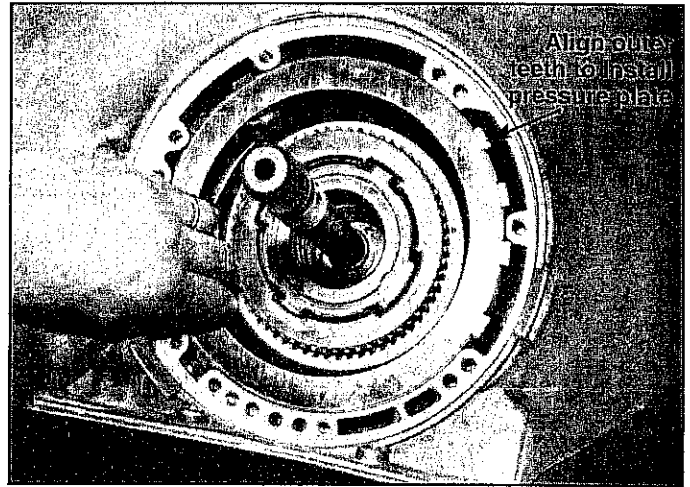

FIGURE 51

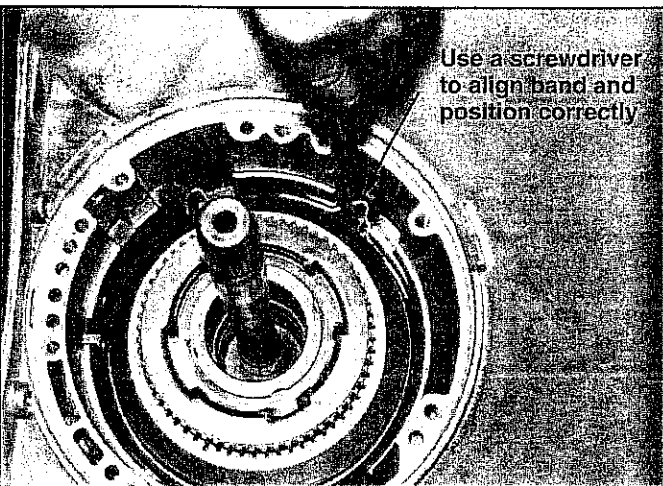

FIGURE 50

STEP 23. Soak the three B&M intermediate clutch plates supplied with the kit in automatic transmission fluid for 15 minutes. Install alternately two or three friction discs and steel plates starting with a friction disc and ending with a steel plate. Install the wavy cushion steel plate against the last steel (See Fig. 8)

STEP 24. Install new O-ring in groove on outside diameter of pump housing. Make sure selective washer is in place on the back of the pump and install three direct clutch hook-type seal rings in place at the direct clutch ring grooves. (See Fig. 52) Spread each ring only as necessary to install it. Hook the ends of the ring together. The rings must spin freely in their grooves. If the rings do not spin freely, use a small file to deburr the grooves. Install two forward clutch hook-type seal rings in place at the forward clutch ring grooves.

STEP 25. Install two guide pins in opposite pump bolt holes. Guide pins can be made from two 5/16-18x2 1/2" bolts with the heads cut off. Install pump gasket. Lubricate the pump O-ring and the metal seal rings with automatic transmission fluid.

STEP 27. Position transmission on bench with valve body surface up. Install new metal seal ring on the intermediate servo piston if it originally had a metal ring. (See Fig. 53) **Do not remove Teflon seal ring.** Lubricate seal ring with automatic transmission fluid and install servo assembly into case. (See Fig. 4)

STEP 28. Install new range selector shaft seal in position on the outside of the range selector shaft bore in the case. Drive the new seal in place using a 1/2" socket or suitable tool as a driver. Install shaft into bore. Install range selector inner lever. There are two types: (See Fig. 54)

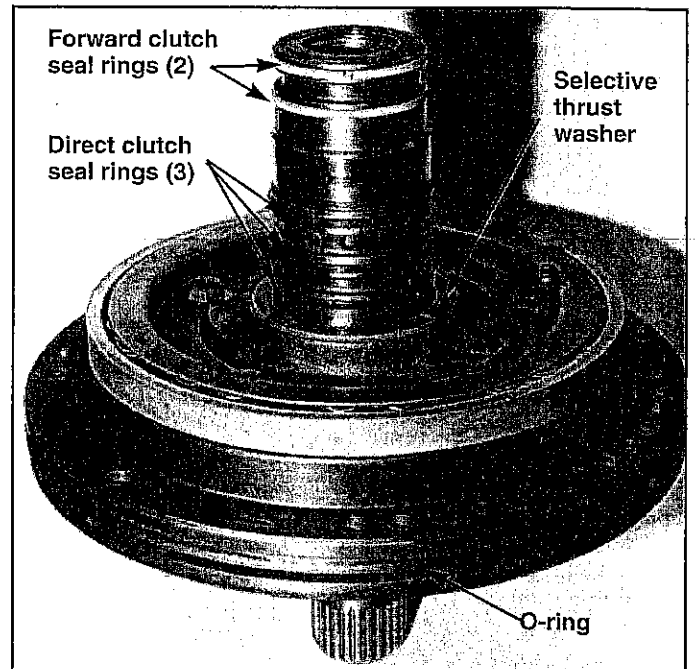

FIGURE 52

Offset link: Early style, 69-70, most models

S-link: Late style, 71 and late

Engage park lock actuator (rod) in range selector inner lever and install lever assembly into case. (See Fig. 4) Install shaft nut in position and tighten nut securely.

STEP 29. Position lever assembly in case and install range selector shaft retainer (clip) onto shaft. Position park lock actuator (rod) and install park lock bracket and bolts. (See Fig. 4) Tighten bolts to 29 lb. ft. The linkage should work smoothly and actuate the park pawl.

The valve body is next. For full manual operation with forward shift pattern install B&M Manualpak #30219 or Transbrake #21005.

STEP 30. Install 1/4" check balls in position as shown in Fig. 4.

Heavy Duty: Two check balls, one each in locations 3 and 4.

Street & Competition: One check ball in location 3 only.

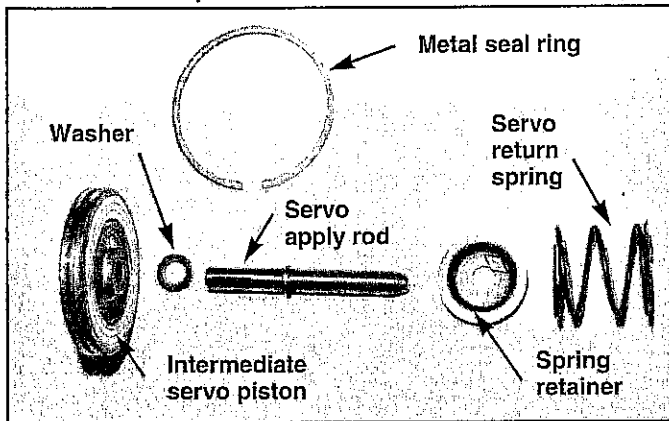

FIGURE 53

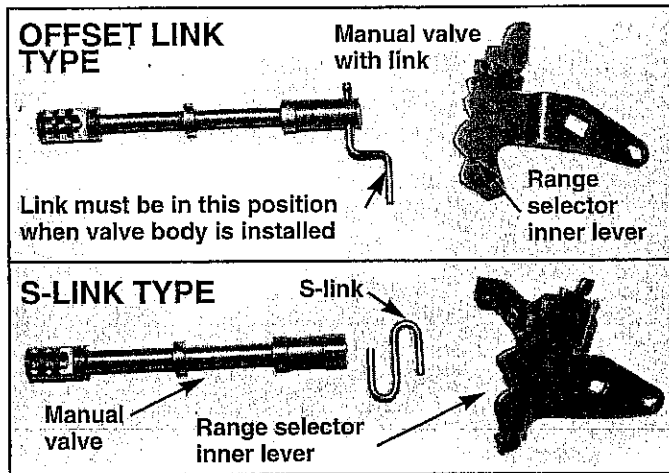

FIGURE 54

STEP 31. Separator plate modification:

Heavy Duty: Use the 3/16" drill supplied with the kit and drill one hole in the B&M plate as shown in Figure 55. Use your stock plate as a guide. Deburr the hole with a file or sandpaper after drilling.

Street & Competition: No modification to separator plate are necessary.

STEP 32. Position both valve body gaskets against the correct separator plate. Note that there are two holes in the separator plate that do not have correct holes punched in the gaskets. (See Fig. 56) Enlarge the one hole and punch the other hole in the gaskets to the same size as the separator plate.

STEP 33. Position upper valve body gasket against case. Install correct separator plate. Position lower valve body gasket (identified by a Z-shaped slot on the gasket) against separator plate. Install the two guide pins into opposite valve body bolt holes to hold plate and gasket in alignment.

STEP 34. Install B&M Middle Support Plate (silver) in position against Separator Plate Gasket at front of transmission (See Fig. 57), and on top of that, position slotted oil transfer plate (gold). Note that holes in Separator Plate, Separator Plate Gasket, Middle Support Plate and slot in oil transfer plate all coincide.

STEP 35. Install stock spacer support plate on top of oil transfer plate. (Order of plates must be correct!) Install seven spacer support plate bolts finger tight. Aligning separator plate to case bolt holes as best as possible, secure the seven spacer support bolts to 100 lb. in. "S" Link Model (See Fig. 54) manual valve range selector inner lever may contact bolt A (See Fig. 57). If lever does not clear by 1/16", mark bolt head interference area and remove bolt and grind a flat angle on bolt head. Check clearance again.

STEP 36. Remove two guide pins. Install lower valve body gasket into position. Use grease to hold it in place. Install manual valve in position in valve body. Install S-link into manual valve,

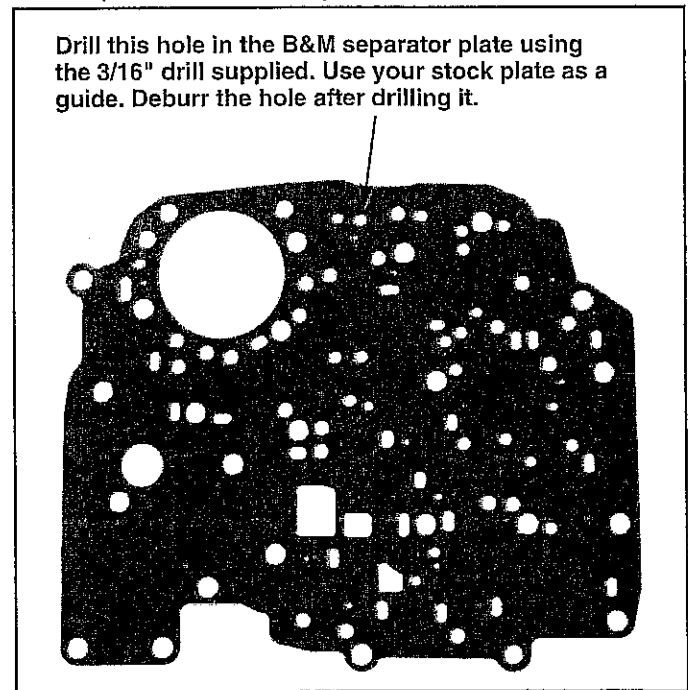

FIGURE 55

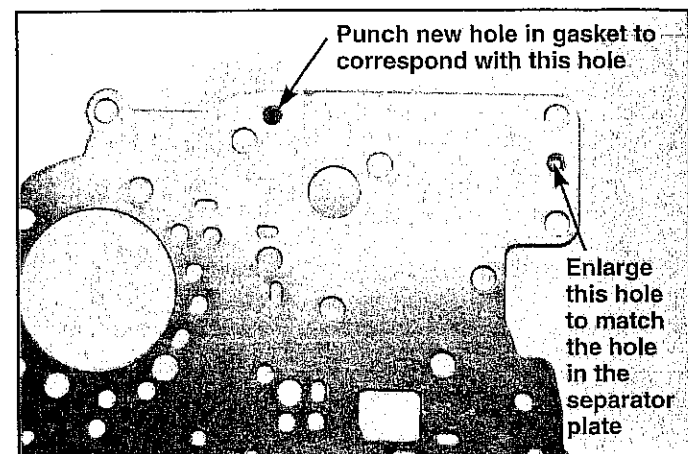

FIGURE 56

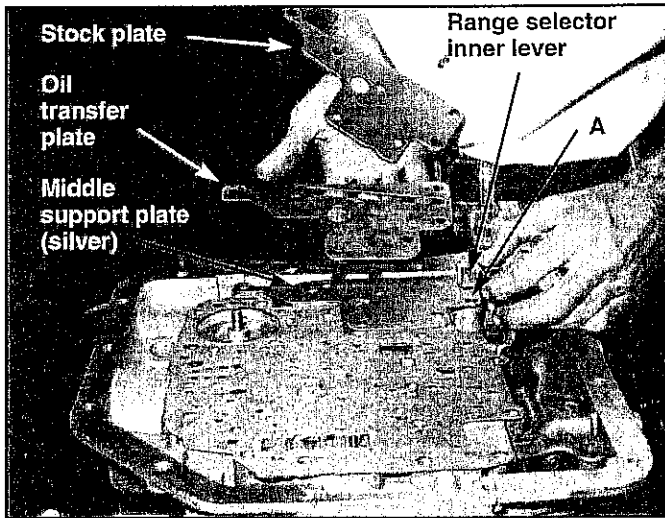

FIGURE 57

if so equipped. Guide valve body into position. Engage manual valve link into range selector inner lever. S-links can only be installed one way. Off-set linkage must be installed with the link in the forward position. (See Fig. 54) Install valve body bolts finger tight. Install detent roller spring so it engages the range selector inner lever. (See Fig. 3)

STEP 37. Tighten valve body bolts to 100 lb. in. Make sure shifter operates freely at this point. The shaft should rotate smoothly with positive indexing in each gear. "S" Linkage Model manual valve only (See Fig. 54). Rotate Range Selector to Park position. Range Selector Inner lever should clear bolt B (See Fig. 3) and detent roller fully indexed into Range Selector inner lever's detent slot. If there is interference, remove bolt and grind small amount off top for clearance. Check clearance again.

STEP 38. Inspect governor gear for damage. Replace as necessary. Lubricate governor bore with automatic transmission fluid and install governor assembly. (See Fig. 58) Install governor cover and O-ring. Do not bend or distort cover. Install retaining clip.

STEP 39. Install speedometer drive gear and clip onto output shaft. Clip installs first with tab engaging hole in the output shaft. Compress clip and slide speedometer drive gear forward until it stops against clip. Stepped end of speedometer gear faces to the rear. If your model is so equipped install output shaft yoke sleeve. (See Fig. 6)

STEP 40. Install new seal in extension housing. Note: 4WD owners will have to purchase seals from a GM dealer. Install O-ring onto front of extension housing. Install extension housing and four bolts. Tighten bolts to 30 lb. ft.

STEP 41. Install new O-ring on speedometer sleeve. Install new inner seal into sleeve with retaining clip. Install speedometer driven gear into sleeve. Lubricate O-ring with automatic transmission fluid. Use retainer to align sleeve and install sleeve into case. Install retainer and bolt. Tighten bolt securely.

STEP 42. Connect detent control wire to kickdown cable. (See Fig. 59) Install new O-ring onto cable housing. Install cable/wire assembly into case hole so wire sticks into case. Install retaining bolt in housing and tighten to 75 lb. in.

STEP 43. Engage detent lever in detent valve wire. Align lever with bracket and install detent valve pin. If detent valve pin contacts support plate and does not fully seat into slot of detent lever, trim pin until just clears support plate. Lever should move freely. If detent lever contacts bolt C (See Fig. 3), remove lever and trim to clearance. Pull on carburetor end of cable to check for smooth operation. If cable is damaged or binding, replace it.

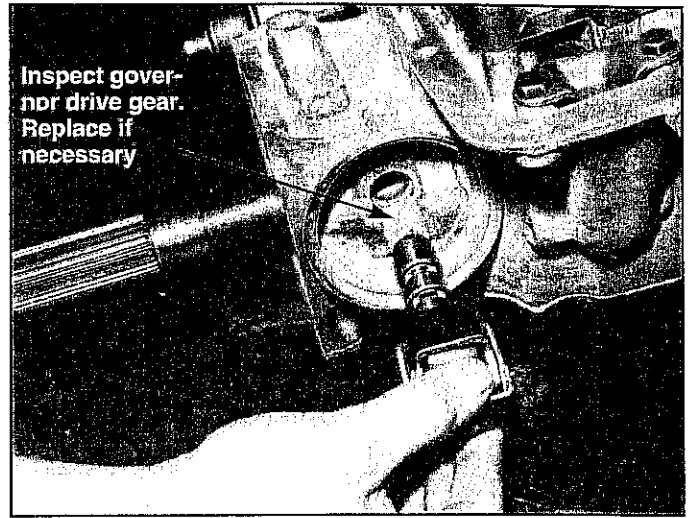

FIGURE 58

Install new oil filter and gasket. Tighten screws to 3 lb. ft. Make sure filter and gasket are properly aligned.

STEP 44. Drill a 1/2" hole in the oil pan in the area shown in Fig. 60. Deburr hole. Install sleeve assembly with plastic gasket on the outside and tighten nut. Hold outer sleeve with a wrench when removing and installing plug. (See Fig. 61) Note: Pans with drain plugs stock do not need to install kit.

STEP 45. Install pan and new gasket. Tighten pan bolts 100 lb. in. Do not overtighten pan bolts as this will cause leaks.

STEP 46. Install new metal seal rings on 1-2 accumulator piston if it originally had metal rings. (See Fig. 62) **Do not remove Teflon seal rings.** Lubricate seal rings with automatic transmission fluid and install piston into case.

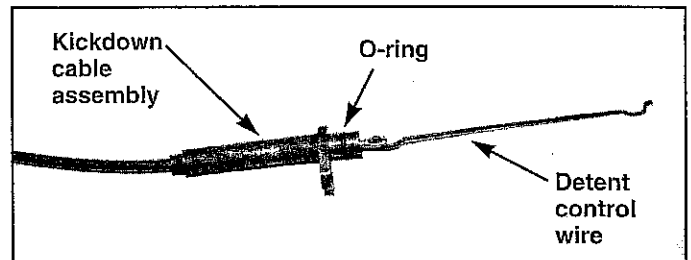
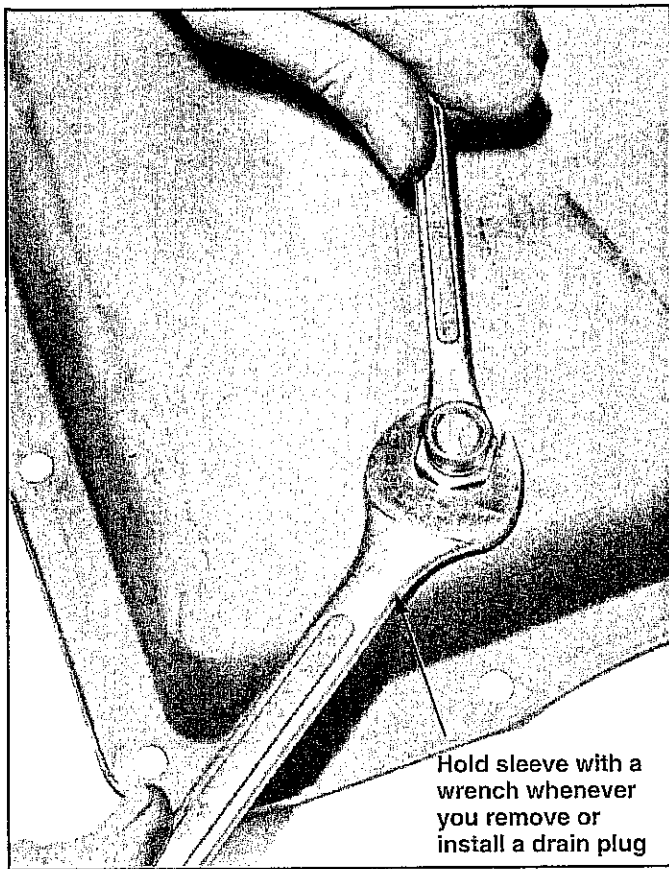

FIGURE 59



FIGURE 60



Hold sleeve with a wrench whenever you remove or install a drain plug

FIGURE 61

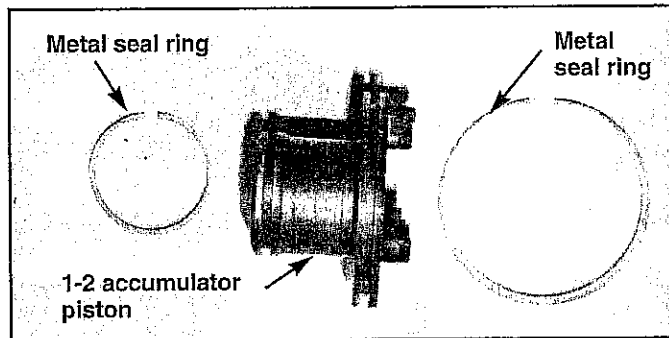

FIGURE 62

STEP 47. Install accumulator cover O-ring into case. Lubricate O-ring with automatic transmission fluid. Install accumulator cover in position and push into place. Install accumulator cover snap ring. Make sure snap ring is fully seated.

STEP 48. Install oil cooler fittings and tighten to 15 lb. ft. Install two or three 1/8" pipe plugs. Install smog control pressure switch, if equipped. (See Fig. 1)

The transmission is now assembled. The final step is installation into the vehicle.

TRANSMISSION INSTALLATION

STEP 1. Lubricate the pump bushing with automatic transmission fluid. Install the torque converter, pushing and rotating until the lug face is a minimum 3/4" inside the bellhousing.

STEP 2. Install transmission/converter assembly against motor. Make sure the converter does not fall out of position. Transmission must fit flush against engine block with no effort. Install bellhousing bolts and tighten 35 to 40 lb. ft. Converter must rotate freely at this point. Check for insufficient engagement or rust in crank pilot bore if it does not turn freely.

STEP 3. Install rear mount and crossmember in place. Tighten mount and crossmember bolts. Install dipstick tube. Connect oil cooler lines.

Heavy Duty and Street: Connect vacuum line to modulator.

Competition: Remove vacuum line and plug at manifold.

STEP 4. Install three converter bolts.

Tighten 30 to 35 lb. ft. Install dust pan and bolts. Tighten to 8 lb. ft. Connect speedometer cable and tighten securely. Connect smog wire to TCS switch, if equipped.

STEP 5. Install driveshaft and tighten U-bolts securely. Connect shift linkage. Check shifter. Adjust according to manufacturer.

STEP 6. Lower vehicle and add 6 quarts of B&M Trick Shift or Type F fluid. Keep the rear wheels off the ground if possible. Start engine and place shifter in the Neutral position. Add fluid until the oil level is between the Add and Full marks. Shift the transmission through all the gear positions. If the rear wheels are off the ground, allow the transmission to shift through all gears several times. Place selector in Neutral and check fluid. Do not overfill. Check for leaks at cooler lines, etc.

STEP 7. Drive vehicle for 1-2 miles to warm up transmission. Check fluid level. It must be between the Add and Full marks. Do not overfill!!! This will cause foaming and overheating.

Heavy Duty: Part throttle shift points can be lowered 5-6 mph by installing the gold spring in back of the modulator valve. (See Fig. 63) Insert spring over end of valve and install valve and modulator as removed. Reconnect vacuum line.

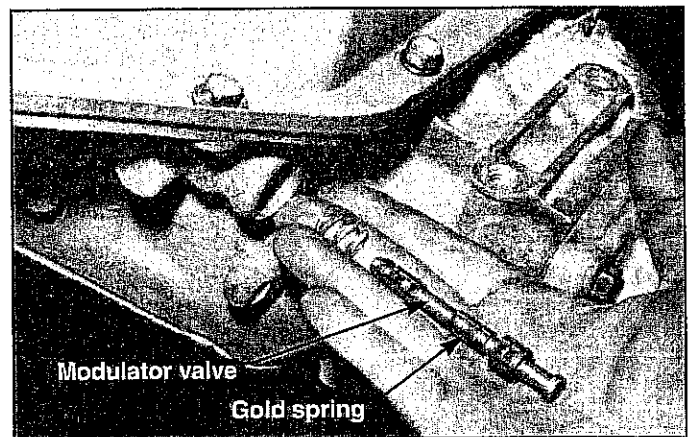

FIGURE 63

TH-350 Trouble Shooting Guide

Malfunction	Probable Cause		
1. Slips	Valve body bolts loose Low fluid level Pump bolts loose Booster and regulator valve improperly installed in valve body Piston lip seals cut or improperly installed Check balls improperly installed Vacuum modulator valve sticking Oil seal rings broken on pump	7. No 3-2 Downshift (No engine braking)	Intermediate servo or accumulator oil rings damaged Servo bore in case damaged Front band broken Front band not engaged in anchor pin in case Front band not engaged in servo pin
2. Slip 1-2 Shift	Check #1 first 1-2 Accumulator piston rings damaged 2-3 Accumulator piston rings damaged 1-2 Accumulator piston bore damaged Intermediate clutch piston seals damaged	8. No. 2-1 Downshift (No engine braking)	Low-reverse piston seals damaged or missing Manual low control valve sleeve improperly installed The above will also affect reverse
3. Slips 2-3 Shift	Check #1 first Direct clutch piston seals damaged Excessive clutch clearance	9. No Reverse	Check #8 first 2-3 Shift valve stuck in 3rd gear position Direct clutch piston seals damaged or missing Pump oil rings damaged or missing Middle support, transfer plate & spacer support plate improperly installed
4. No Drive in "D" Range	Low fluid level Shifter misadjusted Manual valve disconnected from range selector inner lever Forward clutch not operating properly	10. Late Hard Shifts	Vacuum line cracked or leaking Vacuum modulator diaphragm ruptured Kickdown cable loose, damaged or binding Modulator plug installed in Heavy Duty or Street unit
5. No. 1-2 Upshift	Governor sticking Governor drive gear worn or loose Kickdown cable loose, damaged or binding 1-2 Shift valve stuck Intermediate clutch piston seals damaged Valve body bolts loose	11. Pump Buzz or Whine	Low fluid level (oil starvation) High fluid level (foaming) Filter restricted or damaged Valve body and/or spacer support plate bolts loose
6. No 2-3 Upshift	Check #5 first 2-3 Shift valve stuck or improperly installed Valve body bolts loose Direct clutch piston seals damaged Pump oil rings damaged or missing	12. Overheating, Foaming Oil at Dipstick or Breather	Insufficient cooler capacity High fluid level Restricted or plugged cooler lines Pump body or cover excessively warped
		13. No Upshift with Competition Modification	Install vacuum modulator in place of plug (See Section C, Part V, Step 5) but do not connect vacuum modulator

Tools & Materials Required for the TH-350 Transkit Instructions

- | | |
|--|---|
| (1) Speed Handle or Ratchet | (1) Medium Flat File, Fine Tooth |
| (1) 9/16" Socket | (1) Motors or Shop Manual |
| (1) 1/2" Socket | (1) Arkansas Stone |
| (1) 7/16" Socket | (1) Small Hammer |
| (1) 5/8" Open End Wrench | (1) Torque Wrench, 0 to 50 ft.lbs. |
| (1) 11/16" Open End Wrench | (1) 1/4" Drill Motor |
| (1) Crescent Wrench | (1) Vise |
| (1) Small Blade Screwdriver | (2) 5" C-Clamps or Arbor press |
| (1) Medium Blade Screwdriver | (1) Feeler Gage |
| (1) Large Blade Screwdriver | (1) Dial Indicator (Optional) |
| (1) Snap Ring Pliers, Needle Tip, Expansion | (1) 1/4" Punch |
| (1) Snap Ring Pliers, Flat Tip, Expansion | (1) Awl |
| (1) Needle Nose Pliers | (2) Slide Hammer or Length of Chain |
| (1) Spring Retainer Compressor
(Hayden Transtool #T-0151 or equivalent) | (12) Quarts of B&M Trick Shift or Type F Automatic Transmission Fluid |
| | (1) Gallon of Cleaning Solvent
Vaseline or white grease |

TH-350 Transkit Parts List

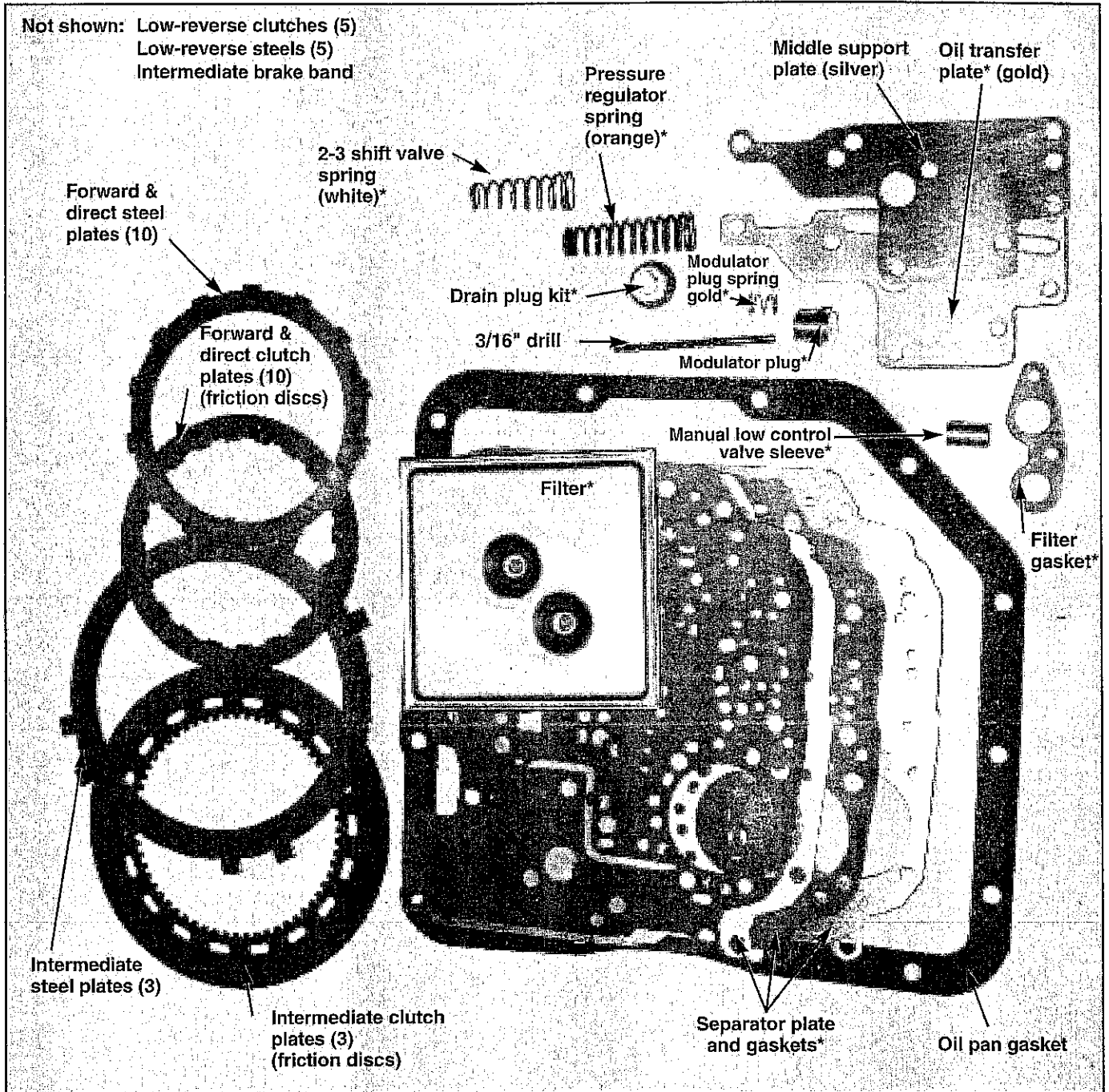

* Packaged in poly bag

Trick Shift™ Automatic Transmission Fluid

Compatible with all automatic transmission fluids including Dexron™, Type F & Mercon™ fluids.

Trick Shift is a blend of foam inhibitors, extreme pressure agents and shift modifiers which in combination provide extended transmission life and dramatically improved shift feel. B&M's Trick Shift Performance Transmission Fluid is the most inexpensive way to measurably improve the transmission performance of your vehicle. You can literally pour in performance. Trick Shift can be mixed with other fluids. However, to attain the maximum improvement you should try to utilize Trick Shift exclusively. Ideal for towing, light trucks and RV applications.



TRICK SHIFT Transmission Fluid - 1 US Quart80259

TRICK SHIFT TEST DATA

TRANSMISSION FLUID COMPARISON TEST RESULTS				
Test	Type "F" Ford Brand	Dexron II	Improved Trick Shift	Specifications
4-Ball wear test (Ave. wear spot dia., mm)	.38 mm	.39 mm	.36 mm	Ford max. allowed .45 mm.
Flash Point	380° F	350° F	385° F	Ford min. 350° F
Fire Point	420° F	390° F	435° F	Ford min. 380° F
Pour Point	-70° F	-45° F	-45° F	Ford min. -40° F
Copper Strip Corrosion	Slight Tarnish 1A	Slight Tarnish 1A	Slight Tarnish 1A	Ford Max. 1B
Viscosity @ 210° F	7.74 cs	7.36 cs	7.72 cs	Ford min. 7.0 cs
Viscosity @ 0° F	1,357 cps	Test ran. at 10° F	1,180 cps	Phoenix lab results acceptable
Viscosity @ -40° F	38,081 cps	50,000 cps (max.)	22,640 cps	
Foaming Tendency and Stability	Acceptable	Acceptable	Acceptable	ASTM D892 Test standards
Rubber Swell % Buna N	- .51 %	+ 2.5 %	+ 3.8 %	Phoenix lab pos. swell acceptable.
Rubber Swell % Silicone	+ 18.21 %	+ 6.5 %	+ 13.11 %	Phoenix lab pos. swell up to 20 % acceptable
Dynamometer Shift Times with Stock TH-400 Trans.	1-2 .95 sec.	1.20 sec.	.99 sec. .65 sec.	B&M Dyno Lab B&M Dyno Lab

TRANSMISSION OIL CAPACITY CHART*

GENERAL MOTORS			
TRANSMISSION	STOCK PAN	WITH B&M DEEP PAN	STOCK TORQUE CONVERTER
Turbo-Hydro 700R4	5 quarts	Add 3 Quarts	4.5 quarts
Turbo-Hydro 400	3 quarts	Add 2 Quarts	7.0 quarts
Turbo-Hydro 350	3 quarts	Add 3 Quarts	6.0 quarts
Powerglide	4 quarts	Add 2 quarts	5.0 quarts
Turbo-Hydro 200	3 quarts		4.5 quarts
CHRYSLER			
TRANSMISSION	STOCK PAN	WITH B&M DEEP PAN	STOCK TORQUE CONVERTER
A-727 TF	4 quarts	Add 4 Quarts	4.0 quarts
A-904 TF	4 quarts	Add 3 Quarts	4.0 quarts
FORD MOTOR COMPANY			
TRANSMISSION	STOCK PAN	WITH B&M DEEP PAN	STOCK TORQUE CONVERTER
C6	5 quarts		5.0 quarts
C4	3 quarts		5.0 quarts
FMX	4 quarts		5.0 quarts
AOD	5 quarts		5.0 quarts
B&M CONVERTER CAPACITIES			
12" Converters	.6 quarts		
11" Converters	.5 quarts		
10" Converters	.4 quarts		
9" Converters	.3 quarts		
8" Converters	.3 quarts		

*Capacities listed are approximated. Note: If you change or remove the valve body get additional oil equal to half your torque converter capacity.

TEST DATA ON TRICK SHIFT

Trick shift has been comparison tested with Dexron™ and Ford Type "F" fluids by two independent laboratories. B&M has also conducted shift time tests on the B&M transmission dyno. See results above left.