

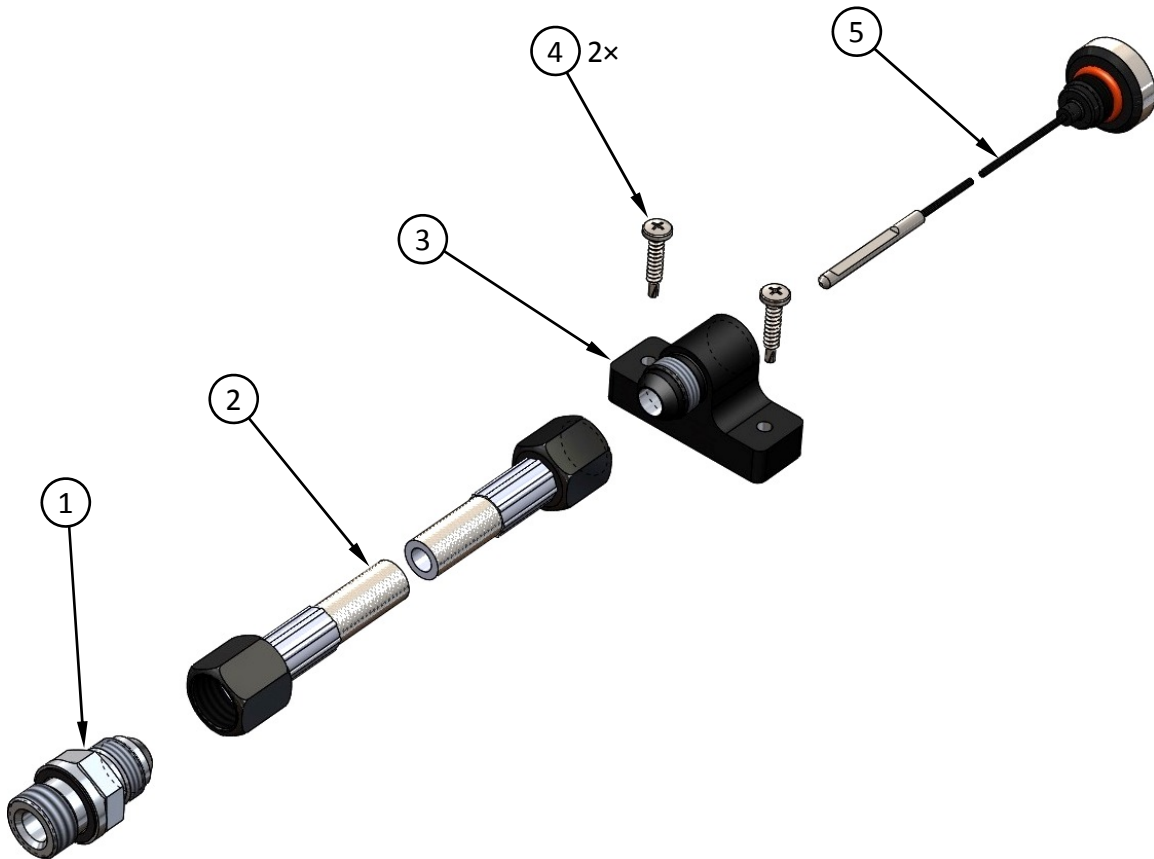

**Installation Instructions for
Part # 22200 REMOTE DIPSTICK
for 2010-2017 FORD F-150 TRUCKS with
4R70E, 4R75E, 6R80 and 10R80 transmissions
(36" tube length; may fit other vehicles)**



PARTS LIST

ITEM NO.	PART NO.	DESCRIPTION	QTY.
1	1601008	FITTING, DIPSTICK TUBE (W/SQUARE-PROFILE O-RING)	1
2	1600976	HOSE ASSY, 36" STAINLESS STEEL / TEFLON	1
3	1601012	ADAPTER, DIPSTICK TUBE	1
4	3401568	SCREW, #10 × 1" SELF-TAPPING	2
5	1601011	DIPSTICK ASSY (W/O-RING)	1
[NOT SHOWN]	5000254	CABLE TIE, 6.75" L × 0.178" W × 0.056" T	2

INTRODUCTION

Thank you for purchasing the **B&M 22200 Remote Dipstick**. This product has been specifically designed for 2010-2017 Ford F-150 trucks equipped with 4R70E, 4R75E, 6R80 and 10R80 transmissions. The kit uses a 36-in. long dipstick tube (braided hose), which may fit other vehicles. Please verify your vehicle's transmission model, and check that the proper tube routing and mounting location can be achieved before beginning installation.

Before starting, take a moment to read and understand these instructions. Use the parts drawing and list to verify your kit's contents. In the unlikely event of missing parts, please contact B&M Technical Support for replacements. We highly recommend that you retain all factory parts.

CAUTION: We highly recommend that this kit be installed prior to any other B&M transmission accessories (e.g., coolers or pans). Installing this kit first will help ensure that the correct fluid level was measured, and that it can be maintained afterward.

Automatic transmission fluid level will vary at different temperatures and operating conditions. Consult your vehicle's service manual or your dealer's service department re. the correct procedure for consistently checking the automatic transmission fluid level and condition.

WARNINGS

- **There is a risk of accident from the vehicle moving by itself when the engine is running. Secure the vehicle to prevent it from moving by itself.**
- **There is a risk of personal injury while working near the engine and transmission with the vehicle running. Wear properly fastened and close-fitting work clothes. Do not touch hot or rotating parts.**

MARK CURRENT TRANSMISSION FLUID LEVEL ON STOCK DIPSTICK

1. Drive the vehicle for 10-15 minutes to bring the transmission fluid up to operating temperature.

2. Using either a lift, or a jack and jack stands, carefully raise the vehicle and securely support it at a sufficient height to allow access to the transmission (approximately 2 feet of ground clearance). **CAUTION: Vehicle must be level, both for personal safety and vehicle stability, and to obtain an accurate fluid level.**
3. Carefully start and run the vehicle at idle. Slowly move the gear shift lever from PARK down through the entire gear range, then back to PARK again, stopping for a few seconds at each gear position. With the transmission in PARK, leave the vehicle running at idle.

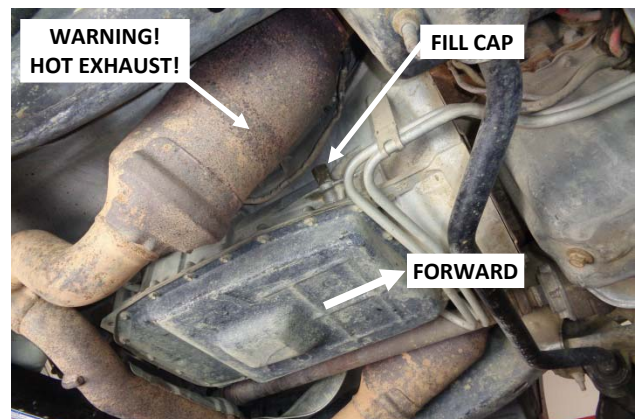

4. Under the vehicle, locate and remove the transmission fill cap. (It is located on the passenger side of the transmission, above and toward the front of the pan.) **WARNING: The exhaust system is extremely hot. Wear suitable gloves and long sleeves to avoid burns.**

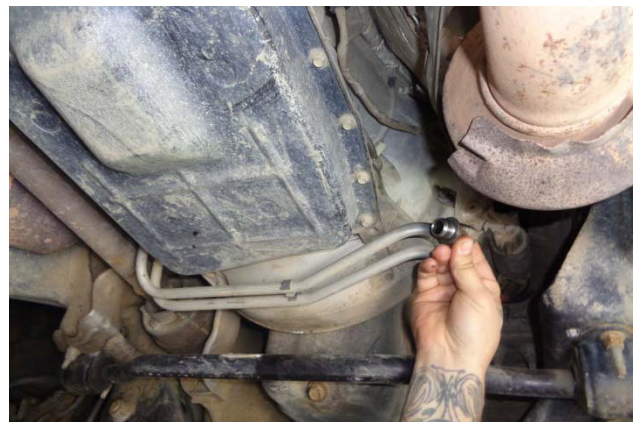

5. Blow or brush off the area around the fill cap, to prevent loose debris from falling into the open port. Then remove the fill cap.



6. Remove the stock dipstick and wipe it off with a clean rag. Then reinsert it, allowing it to seat fully, and remove it again.



7. Mark the fluid level on the dipstick with a marker or grease pencil and carefully set it aside.

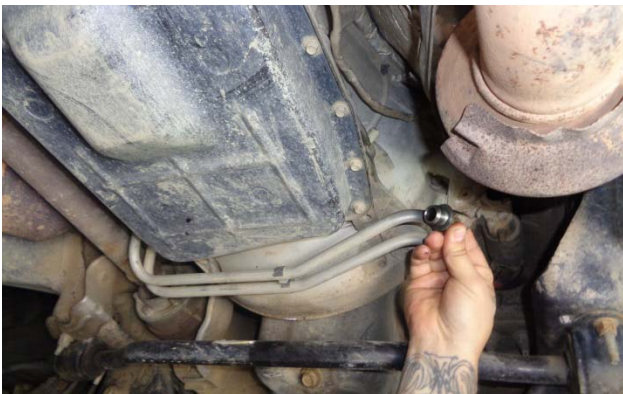

8. Temporarily re-install the stock fill cap, then turn off the vehicle. **NOTE: If the cap is not installed when the vehicle is turned off, the hot (expanded) transmission fluid may overflow the fill port as it returns to the pan.**

INSTALL B&M DIPSTICK

9. Inspect the B&M Remote Dipstick. Repeatedly remove and insert the dipstick (5) in the assembled adapter (3), tube (2) and fitting (1). Note that different bends and curves may cause the dipstick to bind against the tube when it is inserted and removed.

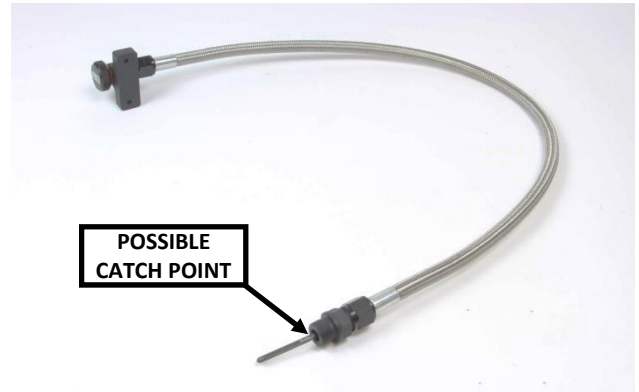

10. Also note if / when the top of the dipstick tip (where it is swaged to the cable) catches on the edge of the fitting (1).

These observations will help you to determine the minimum bend radius the tube can sustain, and to decide how best to route the tube.



11. Find a suitable location on the passenger-side of the firewall to mount the dipstick adapter (3), while also looking for a suitable route for the dipstick tube.



NOTE: On some vehicles, the firewall insulation may cover the entire firewall. The adapter can be fastened directly over the insulation, if necessary.

12. Find a suitable route for the dipstick tube. Keep the dipstick tube from touching exhaust components, as their extreme heat can damage the tube. Also keep the tube from touching wires, brake lines, etc., as the steel braid may cause severe chafing damage. Two cable ties have been included in this kit to secure the tube so as to prevent harmful contact with components.

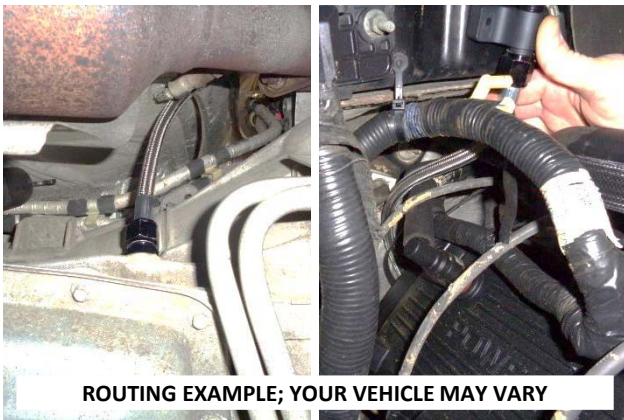

13. Route the tube (2) between the transmission and engine compartment, based on your observations in Steps 9-12.



14. Remove the fill cap. If hot (expanded) fluid begins to run out of the port, reinstall the cap, start the vehicle and run it at idle, then remove the cap.

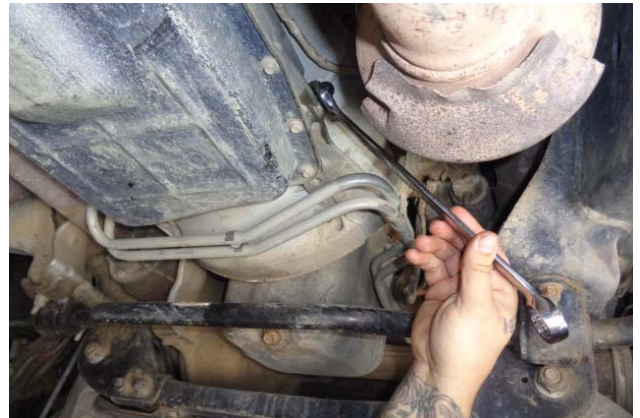

15. Install the dipstick tube fitting (1) in the transmission fill port.

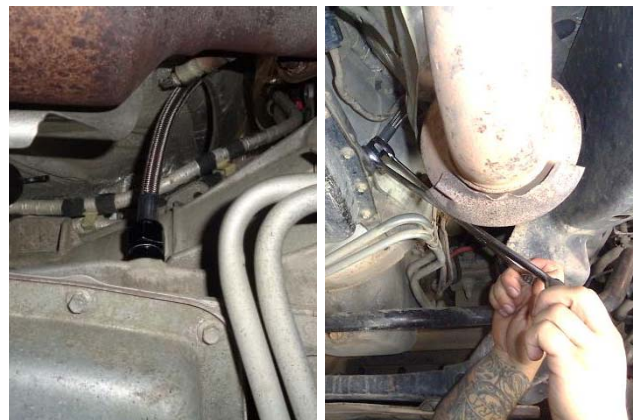

16. Assemble the dipstick tube to the fitting and tighten the nut. **Turn off the vehicle if it is running.**



17. Thread the adapter to the top of the tube, but leave the nut loose at this time.

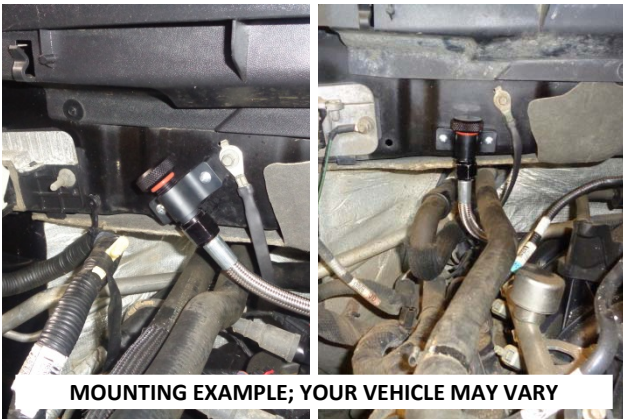

18. Use cable tie(s) to secure the dipstick tube, if required. Fasten the adapter to the chosen location on the firewall using the two self-tapping screws (4).



19. Tighten the upper tube nut.



20. Wipe the dipstick and wire with a clean, lint-free rag to remove any rust preventative oil. Then install the dipstick in the tube, and tighten the knob fully hand-tight (until the o-ring is compressed).

21. Carefully lower the vehicle back to the ground.

TRANSFER FLUID RANGE MARKS FROM STOCK DIPSTICK TO B&M DIPSTICK

22. Drive the vehicle for 10-15 minutes to bring the transmission fluid up to operating temperature, then park on level ground. With the vehicle running at idle, slowly move the gear shift lever from PARK down through the entire gear range, then back to PARK again, stopping for a few seconds at each gear position. With the transmission in PARK, leave the vehicle running at idle.

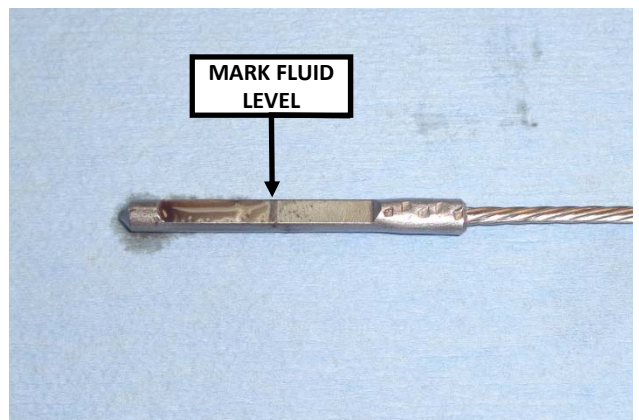

23. Remove B&M dipstick, wipe it off, and reinstall it all the way (knob fully hand tight). Then remove the dipstick again, mark the fluid level with a marker or grease pencil, and turn off the vehicle.

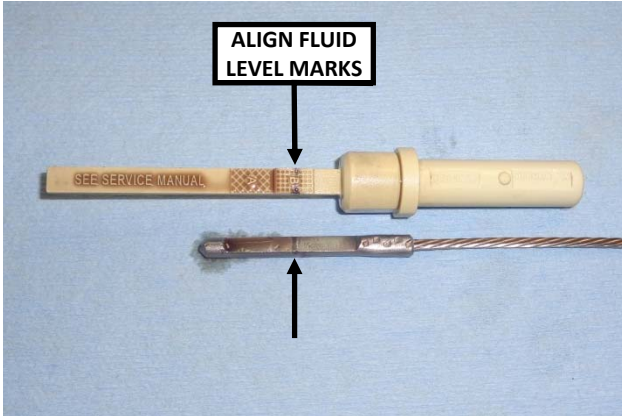

24. Lay the stock and B&M dipsticks next to each other on a bench, and align the two fluid level marks.

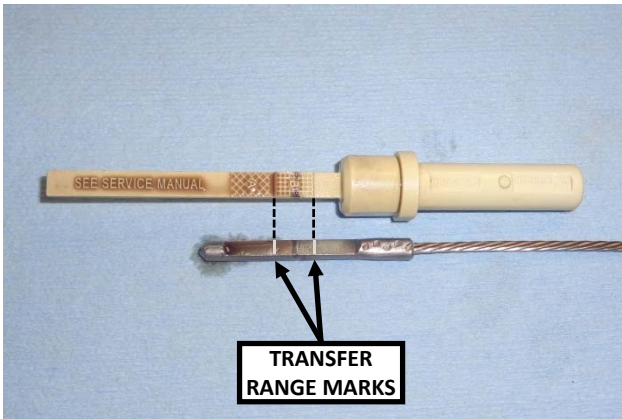

25. Transfer the fluid level range (Max / Min) marks from the stock dipstick to the B&M dipstick. Use a scriber, hacksaw blade or the sharp edge of a needle file to permanently mark the dipstick. Then reinstall the B&M dipstick.

DIPSTICK USE

To accurately monitor your transmission fluid level, it is important to always follow the same procedure when checking it:

- Check the transmission fluid level at operating temperature. If necessary, drive the vehicle for 10-15 minutes to bring the transmission up to temperature.
- Park on level ground. With the vehicle running at idle, slowly move the gear shift lever from PARK down through the entire gear range, then back to PARK again, stopping for a few seconds at each gear position. With the transmission in PARK, leave the vehicle running at idle.

- Remove the dipstick, wipe it off, and reinstall it all the way (with the knob fully hand tight). Then remove the dipstick again to check the fluid level.

ADDING TRANSMISSION FLUID

ONLY USE THE TRANSMISSION FLUID SPECIFIED BY YOUR VEHICLE'S MANUFACTURER.

Add transmission fluid through the dipstick adapter using a 3/8" O.D. rubber hose, and a pump or funnel. **Add fluid slowly, and check often to avoid overservicing.**

(If you should overservice the transmission, disconnect the lower end of the dipstick tube and suck fluid from the transmission pan using a vacuum pump.)

IMPORTANT: RETAIN THESE INSTRUCTIONS FOR FUTURE REFERENCE

B&M Racing & Performance maintains a highly-trained technical service department to answer your technical questions, provide additional product information and offer various recommendations.



Learn more about performance transmission parts we have.