



**BLUE OX®**

# BX2677

2019-22 Ford Edge (ST Trim Only w/ 2.7L EcoBoost)  
(Includes ACC, Shutters, EcoBoost, & Turbo)  
Installation Instructions

Attachment Tab Height: 16.5"

Attachment Tab Width: 30.5"

Serial Number

Please read **BOTH** these Installation Instructions and the General Information sheet prior to installing or operating this equipment.

1. Blue Ox® towing products and accessories are intended to be installed by Blue Ox® Dealers who are familiar with our products and have the equipment and knowledge necessary to do "fit work".
2. Many Blue Ox® baseplates are designed to use existing holes and hardware to mount the baseplate to the towed vehicle. Even though bolts are there, do not assume they are adequate for baseplate mounting. Always use the hardware supplied in the hardware kit and existing hardware as specified in the installation instructions.

### Bolt Torque Specifications

Torque in Foot-Pounds for Inch Bolts

Bolt Size	Grade 5	Grade 8
1/4"	10	14
5/16"	19	29
3/8"	33	47
7/16"	54	78
1/2"	78	119
5/8"	154	230
3/4"	257	380



### Bolt Torque Specifications

Torque in Foot-Pounds for Metric Bolts

Bolt Size	Grade 8.8	Grade 10.9
6MM	6	8
8MM	16	22
10MM	31	40
12MM	54	70
14MM	89	117
16MM	161	230
18MM	222	318

Reference your vehicle owner's manual for manufacturer's towing specifications.



## WARNING

Failure to read and follow these instructions could result in separation of the towed vehicle from the tow bar, causing property damage, loss of towed vehicle, personal injury or death.

BX2677  
2019-2022 Ford Edge (ST Trim Only w/ 2.7L EcoBoost)  
(Includes ACC, Shutters, EcoBoost, & Turbo)  
Installation Instructions

**Instruction Notes:** The fascia and headlights are removed and reinstalled for the baseplate installation. Some drilling and trimming is required.

Place all components that are removed on a flat, sturdy surface. All items will be reinstalled unless otherwise noted after the baseplate is installed.

The dimensional variations between otherwise identical vehicles can be considerable. While the baseplate was designed for easy installation, it may be necessary to tailor the baseplate slightly to compensate for vehicle manufacturer's tolerances.

The BX88334 Tail Light Wiring Kit is recommended for this vehicle.

## ***NOTICE***

- Handling of some cosmetic parts when installing this product may require the use of protective covers, rags, specialty tools, etc. to prevent damage.
- When using power drills be aware of the dangers of torque and drill bit length.
- When using a reciprocating saw be aware of objects behind the cutting surface.
- Use a good quality paint to spray cut edges of frame to prevent rusting.
- Be sure that **ALL** electrical connections are plugged in and accessories are functioning properly before reinstalling the fascia.
- The baseplate is computer tested to your vehicle's GVWR, exceeding this weight will void the manufacturer's warranty.
- Be sure to use a sufficient amount of Loctite® Red on all bolt threads before tightening. Tighten all bolts according to the torque chart provided unless specified.
- Dealer or installer be certain the user receives these instruction sheets.
- If the baseplate is in an accident, it must be replaced. **DO NOT** use it again! An accident can cause unseen damage and using it again could result in more damage or serious injury. **DO NOT** use the baseplate if it is damaged or missing parts.

**BX2677**  
**2019-2022 Ford Edge (ST Trim Only w/ 2.7L EcoBoost)**  
**(Includes ACC, Shutters, EcoBoost, & Turbo)**  
**Installation Instructions**

**Tools Required**

- Flat Screwdriver
- Utility Knife
- Torque Wrench
- Drill
- Loctite® RED
- 3/8" Drill Bit
- 1/2" Drill Bit
- 1-1/4" Hole Saw
- 5/16" Nut Driver
- 5.5MM Socket
- 7MM Socket
- 7MM Wrench
- 8MM Socket
- 10MM Socket
- 3/8" Socket
- 3/8" Wrench
- 7/16" Socket
- 7/16" Wrench
- 9/16" Socket
- 9/16" Wrench
- 3/4" Socket
- 3/4" Wrench

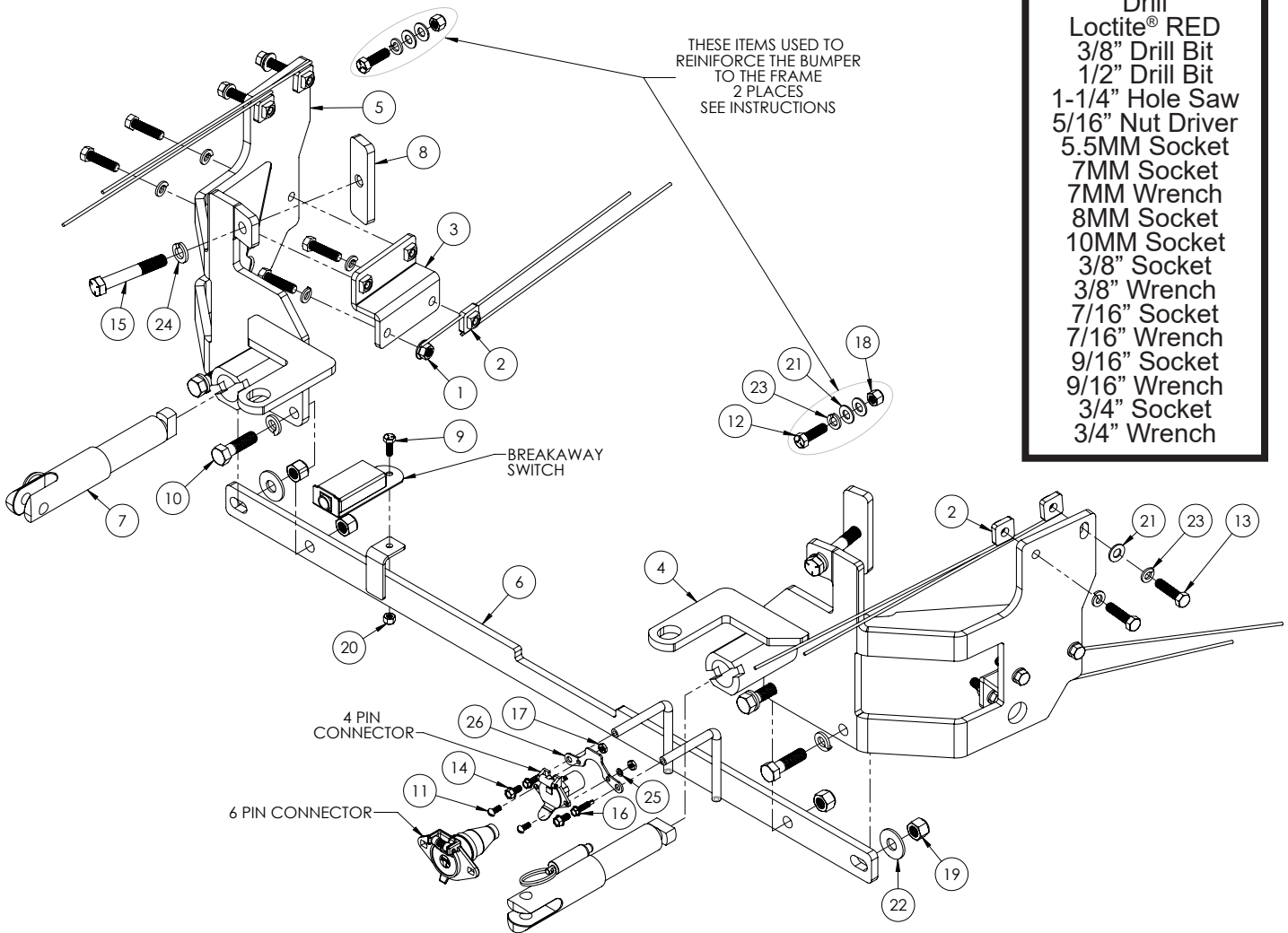

**Important:**

Use only genuine factory replacement parts on your baseplate. Do **NOT** substitute homemade or non-typical parts. If a bolt is lost or in need of replacement, for your safety and the preservation of your baseplate, be sure to use a replacement bolt of the same grade (In most cases it will be Grade 5, please reference the parts list above). Replacement parts may be ordered through your nearest Blue Ox® Dealer or Distributor. Failing to follow and/or altering these installation instructions in either installation or required equipment will void the manufacturer's warranty. Towing behind a non-motorized vehicle will void the warranty.

**BX2677**  
**2019-2022 Ford Edge (ST Trim Only w/ 2.7L EcoBoost)**  
**(Includes ACC, Shutters, EcoBoost, & Turbo)**  
**Installation Instructions**

Item No.	Part No.	Description	Qty.
1	61-4978	3/8"-16 Whiz Nut w/ 14" Wire	2
2	61-5208	3/8" Nut Plate w/ 14" Wire	6
3	61-7681	Support Plate	2
4	61-8162	BX2677 Baseplate, DS	1
5	61-8163	BX2677 Baseplate, PS	1
6	61-8164	BX2677 Baseplate, Center	1
7	62-3469	Attachment Tab Assembly with Hole	2
8	102-7749	3/8" x 1-1/4" x 4" Flat w/ 1/2" Tapped Hole	2
9	201-0050	1/4"-20 x 3/4" Hex Head Bolt, Grade 5, ZP	1
10	201-0068	1/2"-13 x 1-3/4" Hex Head Bolt, Grade 5, ZP	4
11	201-0192	#10-32 1/2" Round Slotted Head Screw	2
12	201-0368	3/8"-16 x 1-1/4" Hex Head Bolt, Grade 5, ZP	2
13	201-0440	3/8"-16 x 1-1/2" Hex Head Bolt, Grade 5, ZP	12
14	201-0553	1/4"-20 x 1/2" Self Drilling Screw, ZP	2
15	201-0799	1/2"-13 x 3-1/4" Hex Head Bolt, Grade 5, ZP	2
16	201-0979	#12-14 x 1" Self Drilling Screw, ZP	2
17	202-0047	#10-32 Hex Nut	2
18	202-0090	3/8"-16 Hex Nylon Insert Lock Nut, ZP	2
19	202-0094	1/2"-13 Hex Nylon Insert Lock Nut, ZP	4
20	202-0102	1/4"-20 Hex Nylon Nut, ZP	1
21	203-0003	3/8" Flat Washer, ZP	6
22	203-0005	1/2" Flat Washer	2
23	203-0010	3/8" Lock Washer, ZP	14
24	203-0012	1/2" Lock Washer, ZP	6
25	203-0054	#10 Lock Washer, ZP	2
26	299-0685	Electrical Bracket	1
27	226-0049(not shown)	Class IV Safety Cables	2
28	229-0512(not shown)	3/8" Quicklink, ZP	2
29	290-0437(not shown)	Black Cap Plug Receiver	2

**Important:**

Use only genuine factory replacement parts on your baseplate. Do **NOT** substitute homemade or non-typical parts. If a bolt is lost or in need of replacement, for your safety and the preservation of your baseplate, be sure to use a replacement bolt of the same grade (In most cases it will be Grade 5, please reference the parts list above). Replacement parts may be ordered through your nearest Blue Ox® Dealer or Distributor. Failing to follow and/or altering these installation instructions in either installation or required equipment will void the manufacturer's warranty. Towing behind a non-motorized vehicle will void the warranty.



BX2677  
2019-2022 Ford Edge (ST Trim Only w/ 2.7L EcoBoost)  
(Includes ACC, Shuttters, EcoBoost, & Turbo)  
Installation Instructions

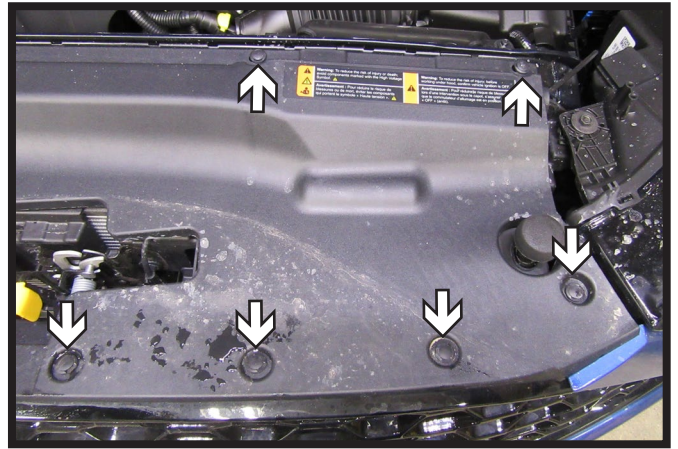
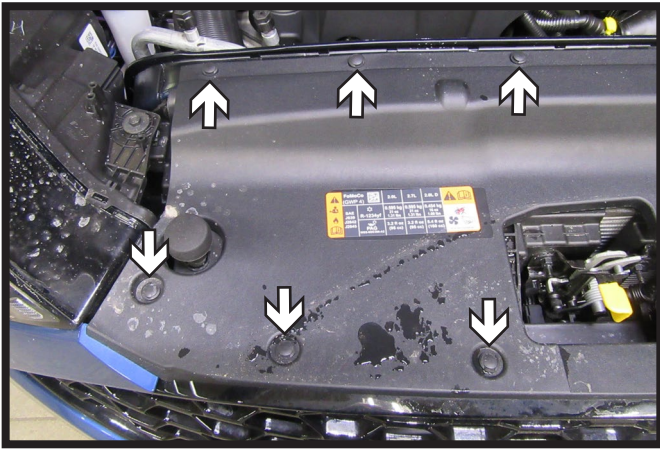

1. Remove the twelve (12) push pins from the fascia cover. There are six (6) on each side. Set cover aside to be reinstalled later.

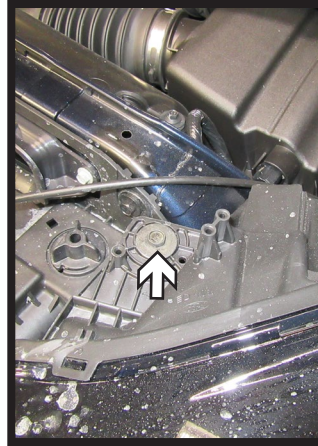
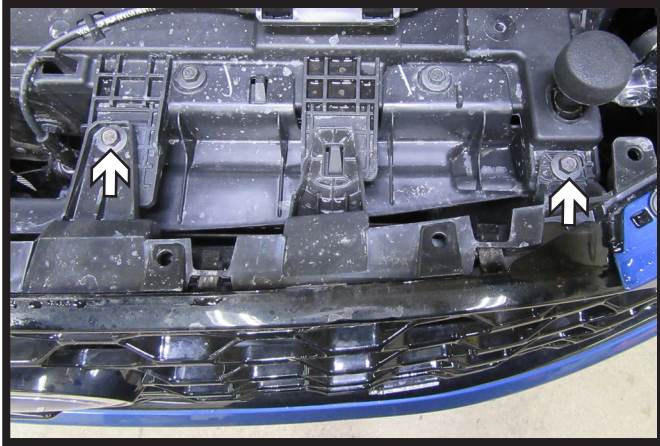

2. Using a 10MM socket, remove the four (4) bolts from the top edge of the fascia. There are two (2) on each side.
3. Using a 10MM socket, remove the two (2) bolts (white) from the headlight. Then remove the one (1) push pin (gray). Disconnect all electrical connections and set the headlight aside to be reinstalled later. Do this on both sides of the vehicle.

BX2677  
2019-2022 Ford Edge (ST Trim Only w/ 2.7L EcoBoost)  
(Includes ACC, Shuttters, EcoBoost, & Turbo)  
Installation Instructions

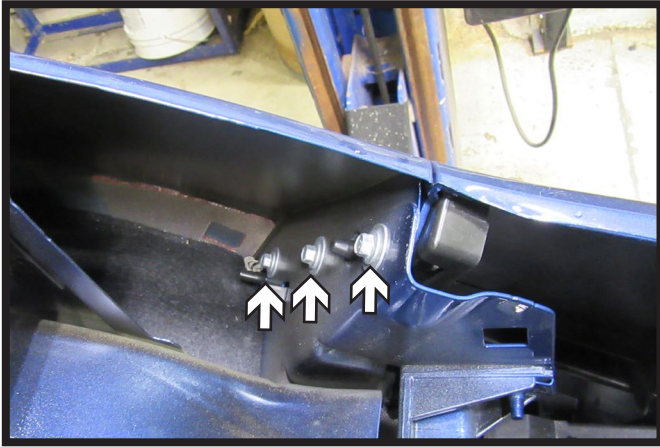

4. Using an 8MM socket, remove the three (3) bolts from the fascia/fender joint underneath where the headlight was. Do this on both sides of the vehicle.



5. Using a 5.5MM socket, remove the four (4) bolts (white) and two (2) push pins (gray) from the edge of the wheel well. Do this on both sides of the vehicle.



6. Using a 5.5MM socket, remove the ten (10) bolts from the underside of the fascia. There are five (5) on each side.

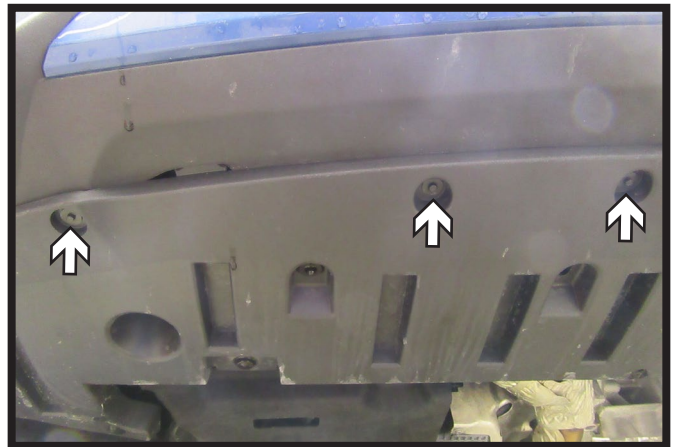



BX2677  
2019-2022 Ford Edge (ST Trim Only w/ 2.7L EcoBoost)  
(Includes ACC, Shutters, EcoBoost, & Turbo)  
Installation Instructions

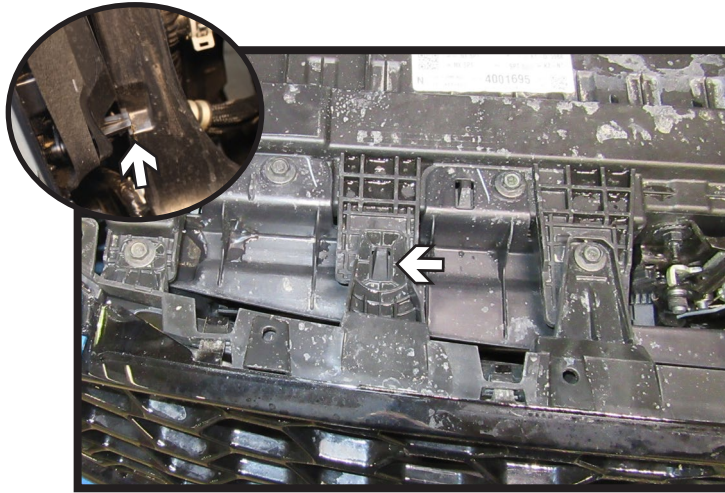

7. Unsnap the fascia by the headlight locations (inset). Lift piece over the two (2) hooks on the top of the fascia. Pull the corners of the fascia away from the vehicle disconnecting any electrical connections and set the fascia aside to be reinstalled later.

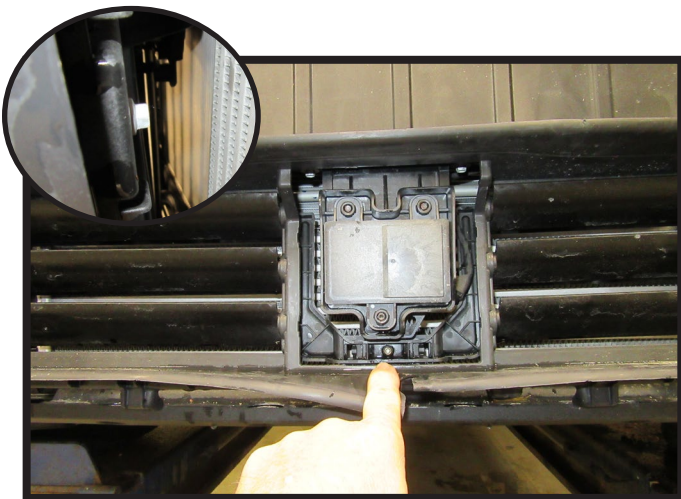

8. Using a 7MM wrench on backside (inset), remove the indicated bolt from the bottom of the shutter housing (left). Then using a utility knife cut along the top and around the edge of the housing as indicated (right). Unsnap the bottom of the shutter housing, remove, and set aside. It will not be reinstalled later.

BX2677  
2019-2022 Ford Edge (ST Trim Only w/ 2.7L EcoBoost)  
(Includes ACC, Shutters, EcoBoost, & Turbo)  
Installation Instructions

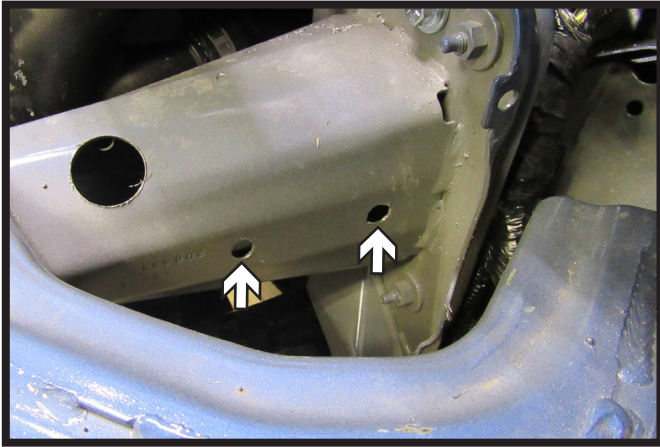

9. Using a 3/8" drill bit, ream out the two (2) existing holes. Do this on both sides of the vehicle.

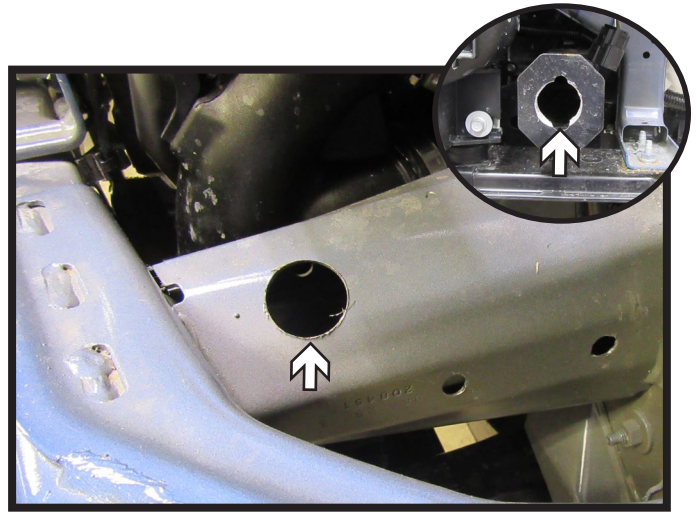

10. Using a 1-1/4" hole saw, drill access holes in the side of the frame as shown and in the face of the lower support (inset). Do this on both sides of the vehicle.

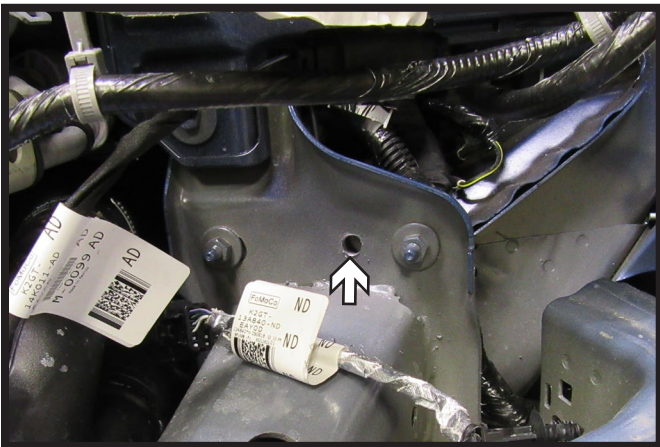

11. Using a 3/8" drill bit, drill one (1) hole as indicated on both sides of the vehicle then install the provided 3/8" hardware.

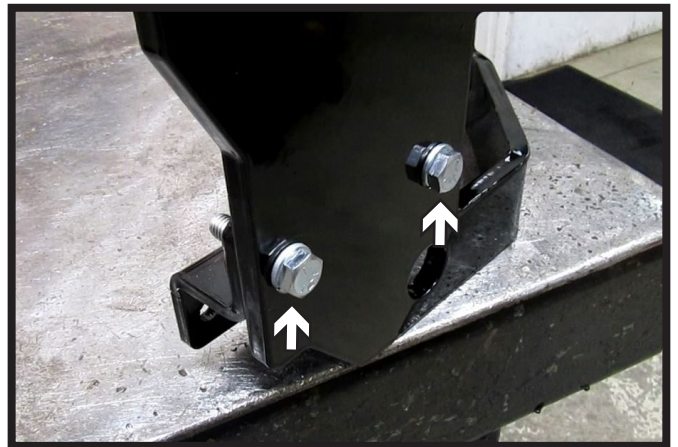

12. Attach the Z bracket to the back of each side plate using two (2) 3/8" bolts and hardware.

**\*\* Use Loctite® Red on all bolt threads and tighten all bolts to the appropriate torque.\*\***



BX2677  
2019-2022 Ford Edge (ST Trim Only w/ 2.7L EcoBoost)  
(Includes ACC, Shuttters, EcoBoost, & Turbo)  
Installation Instructions

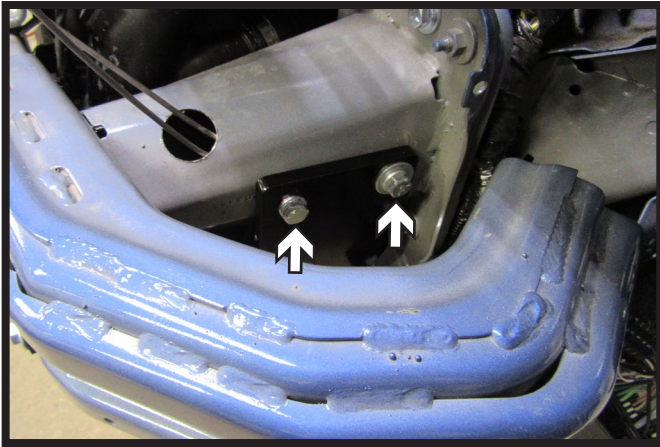

13. Install the baseplate onto the frame with the provided 3/8" hardware, making sure to not yet fully tighten the hardware. Do this on both sides of the vehicle.

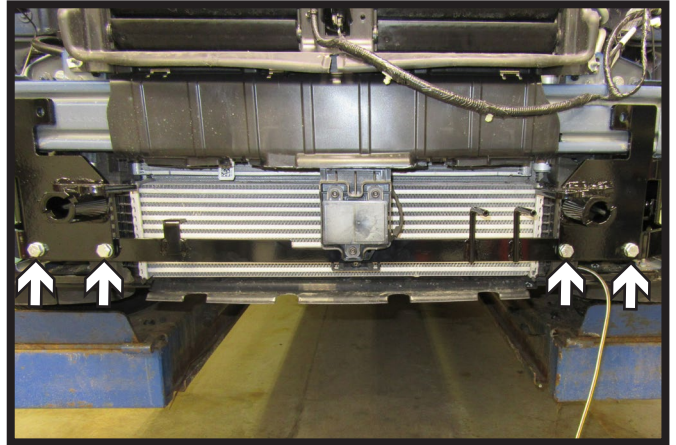

14. Install the cross-member on the back side of the side brackets with provided 1/2" hardware, making sure to not yet fully tighten the hardware. Then tighten the top two (2) bolts on both side plates followed by the bolts on the cross-member.

**Note:** Cross member may appear bowed once the bolts have been fully tightened.

**\*\* Use Loctite® Red on all bolt threads and tighten all bolts to the appropriate torque.\*\***

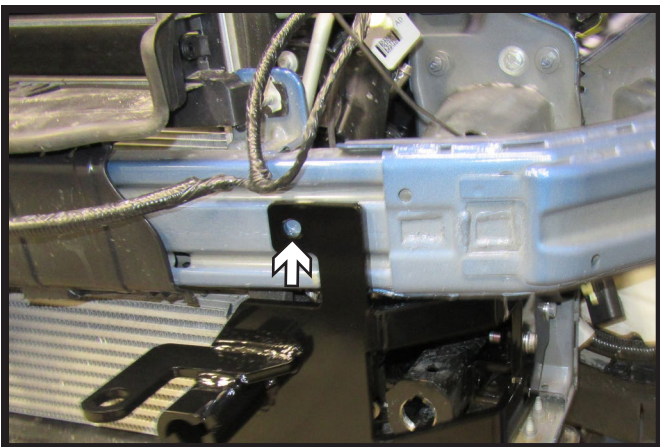

15. Using a 1/2" drill bit, drill one (1) hole as indicated on both sides of the vehicle.

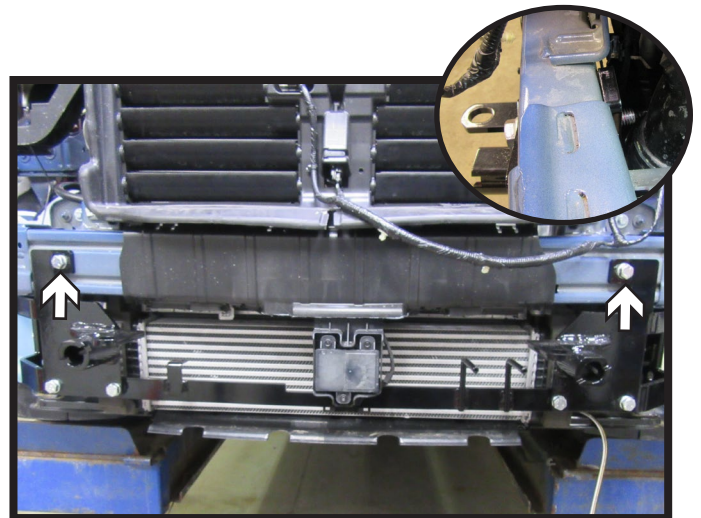

16. Install the 1/2" Bolts with lock washer and a nut plate on the back side. Do this on both sides of the vehicle.

**\*\* Use Loctite® Red on all bolt threads and tighten all bolts to the appropriate torque.\*\***

BX2677  
2019-2022 Ford Edge (ST Trim Only w/ 2.7L EcoBoost)  
(Includes ACC, Shutters, EcoBoost, & Turbo)  
Installation Instructions

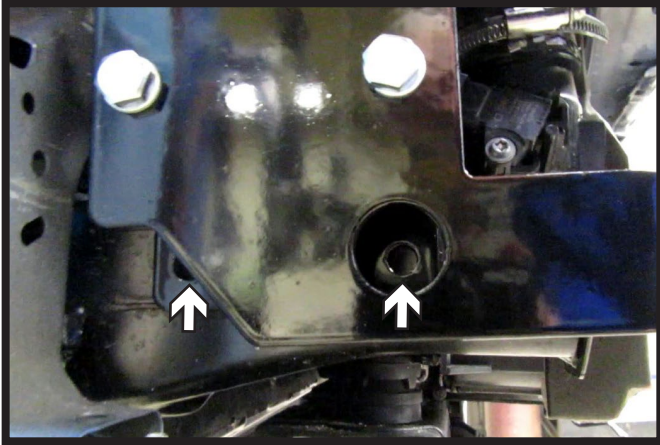

17. Using a 3/8" drill bit, drill out the bottom two (2) holes using the holes on the side plate as a guide. Install the provided 3/8" hardware. Do this on both sides of the vehicle.

**\*\* Use Loctite® Red on all bolt threads and tighten all bolts to the appropriate torque.\*\***

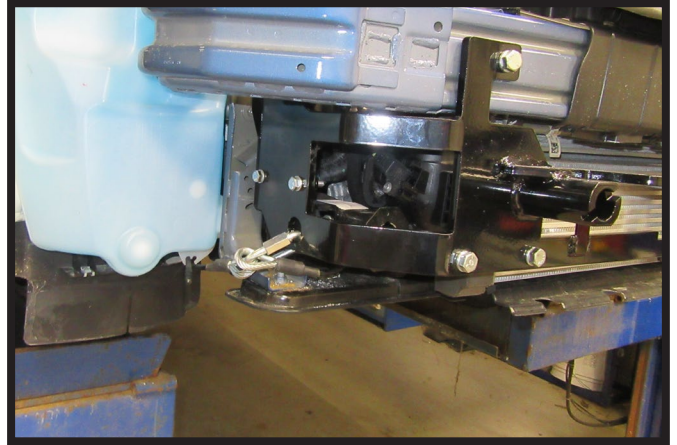

18. Attach the permanent baseplate safety cables to the provided convenience link on the baseplate. The photo above shows the recommended installation of the cables to frame of vehicle. Additional options may interfere with suggested mounting; in this case, secure the cables to a solid piece of the frame as described in the General Information sheet. Be sure the safety cables do not rub against any hoses or moving parts. Do this on **BOTH** sides of the vehicle.

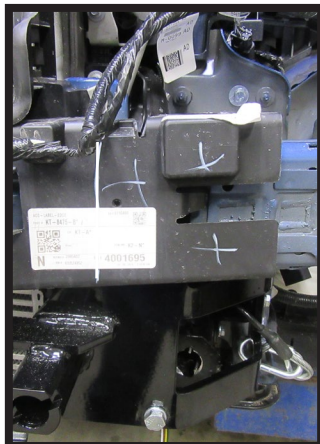
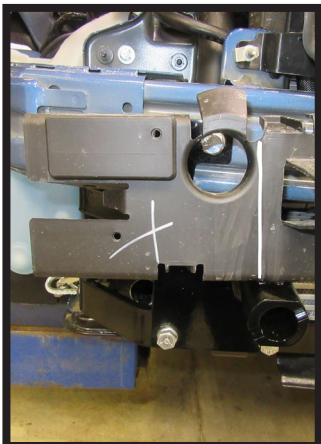

19. Using a utility knife, trim the bumper cover on both sides of the vehicle as indicated to allow clearance for the baseplate.



20. Hold the fascia as close to its original position, mark and trim the fascia around the convenience links and attachment tabs. Reinstall the fascia, fascia cover, and headlights.



# General Information

1. It is crucial to register your product(s) so that you may be alerted of product offerings, updates, upgrades, maintenance and safety bulletins, and/or recalls.
2. **It is the owner's responsibility to inspect all towing equipment for cracked welds, missing or worn parts and loose bolts before each towing trip.** Be sure to use Loctite® Red on all bolts and tighten to the recommended specifications.
3. **It is the owner's responsibility to hook up all towing equipment per manufacturer's instructions/ recommendations.**
4. Remove the attachment tabs when not in use (if applicable).

## Notice To Baseplate Installer

### 1. It is YOUR responsibility to watch for:

- Oil cooler and air conditioner lines
- Electrical wires and hoses
- Missing parts or attaching points on the frame

\*\* If the baseplate is improperly installed and is against a wire or hose, it could cause fluid leaks or electrical shorts some time after the actual baseplate installation.

## Permanent Baseplate Safety Cable Installation

Permanent baseplate safety cables are strongly recommended when towing a vehicle with a tow bar. The principle function of the permanent baseplate safety cables is to prevent the towed vehicle from breaking loose in the event the connection between the frame of the towed vehicle and the baseplate fails or becomes disconnected. The cables must be connected from the baseplate to the frame rail or cross member of the vehicle's frame. The illustrations below show the possible arrangements recommended by Blue Ox®. Each permanent baseplate safety cable must have an adequate weight rating for the towing system. The weight rating of the two (2) cables together will not qualify.

***Do not mount the permanent baseplate safety cables against wires, hoses or brake lines.***

These permanent baseplate safety cables should remain installed as long as the baseplate is installed on the vehicle. Permanent baseplate safety cables are to be used in conjunction with, and NOT a replacement for legally required safety cables attaching the towed vehicle to the towing vehicle.

### Option #1

(Baseplates with Convenience Link Tabs)

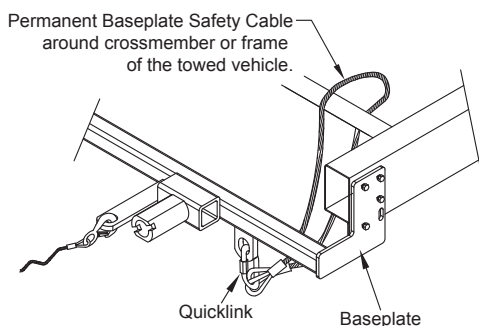

### Option #2

(Baseplates with out Convenience Link Tabs)

