



**BLUE OX®**

**BX1721**  
2015-18 Chevy Colorado (4WD)(Includes Denali)  
2017-18 Chevy Colorado ZR2  
2015-18 GMC Canyon (4WD)(Includes Denali)

**Installation Instructions**

Please read BOTH these Installation Instructions and the General Instructions prior to installing or operating this equipment.

**Attachment Tab Height: 23"**

**Attachment Tab Width: 27"**

1. Blue Ox® towing products and accessories are intended to be installed by Blue Ox® Dealers who are familiar with our products and have the equipment and knowledge necessary to do "fit work".
2. Many Blue Ox® baseplates are designed to use existing holes and hardware to mount the baseplate to the towed vehicle. Even though bolts are there, do not assume they are adequate for baseplate mounting. Always use the hardware supplied in the hardware kit and existing hardware as specified in the installation instructions.



Chevy Colorado



GMC Canyon



Chevy Colorado ZR2

**Bolt Torque Specifications**

Torque in Foot-Pounds for Inch Bolts

| Bolt Size | Grade 5 | Grade 8 |
|-----------|---------|---------|
| 1/4"      | 10      | 14      |
| 5/16"     | 19      | 29      |
| 3/8"      | 33      | 47      |
| 7/16"     | 54      | 78      |
| 1/2"      | 78      | 119     |
| 5/8"      | 154     | 230     |
| 3/4"      | 257     | 380     |

**Bolt Torque Specifications**

Torque in Foot-Pounds for Metric Bolts

| Bolt Size | Grade 8.8 | Grade 10.9 |
|-----------|-----------|------------|
| 6MM       | 6         | 8          |
| 8MM       | 16        | 22         |
| 10MM      | 31        | 40         |
| 12MM      | 54        | 70         |
| 14MM      | 89        | 117        |
| 16MM      | 161       | 230        |
| 18MM      | 222       | 318        |



**WARNING**

Failure to read and follow these instructions could result in separation of the towed vehicle from the tow bar, causing property damage, loss of towed vehicle, personal injury or death.

BX1721  
2015-18 Chevy Colorado/GMC Canyon (4WD) (Includes Denali)  
2017-18 Chevy Colorado ZR2  
Installation Instructions

**Reference your vehicle owner's manual for  
manufacturer's towing specifications.**

**Instruction Notes:** The fascia, bumper, tow hooks and air baffle are removed and reinstalled for the baseplate installation. Some trimming is required.

Place all components that are removed on a flat, sturdy surface. All items will be reinstalled unless otherwise noted after the baseplate is installed.

The dimensional variations between otherwise identical vehicles can be considerable. While the baseplate was designed for easy installation, it may be necessary to tailor the baseplate slightly to compensate for vehicle manufacturer's tolerances.

The BX8869 Tail Light Wiring Kit is recommended for this vehicle.



Drill a hole according to the tail light  
wiring kit instructions.

### **NOTICE**

- Handling of some cosmetic parts when installing this product may require the use of protective covers, rags, specialty tools, etc. to prevent damage.
- When using power drills be aware of the dangers of torque and drill bit length.
- When using a reciprocating saw be aware of objects behind the cutting surface.
- Use a good quality paint to spray cut edges of frame to prevent rusting.
- Be sure that **ALL** electrical connections are plugged in and accessories are functioning properly before reinstalling the fascia.
- The baseplate is computer tested to your vehicle's GVWR, exceeding this weight will void the manufacturer's warranty.
- Be sure to use a sufficient amount of Loctite® Red on all bolt threads before tightening. Tighten all bolts according to the torque chart provided.
- Dealer or installer be certain the user receives these instruction sheets.
- If the baseplate is in an accident, it must be replaced. **DO NOT** use it again! An accident can cause unseen damage and using it again could result in more damage or serious injury. **DO NOT** use the baseplate if it is damaged or missing parts.

**BX1721**  
**2015-18 Chevy Colorado/GMC Canyon (4WD) (Includes Denali)**  
**2017-18 Chevy Colorado ZR2**  
**Installation Instructions**

| <u>Required Tools</u> |             |             |
|-----------------------|-------------|-------------|
| Flat Screwdriver      | 7MM Socket  | 18MM Wrench |
| Utility Knife         | 10MM Socket | 3/4" Socket |
| Reciprocating Saw     | 15MM Socket | 3/4" Wrench |
| Torque Wrench         | 15MM Wrench | T15 Torx    |
| Loctite® RED          | 18MM Socket |             |

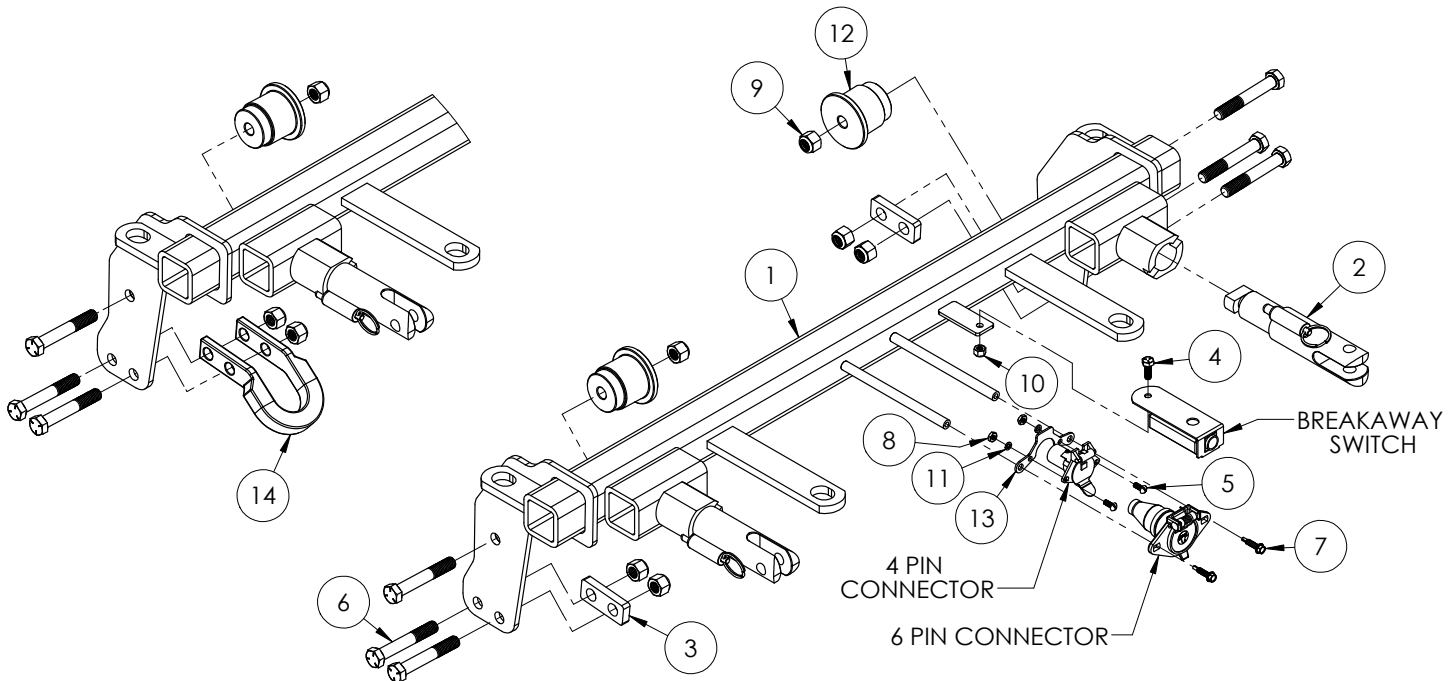

| Item No. | Part No.                  | Description                                       | Qty. |
|----------|---------------------------|---|------|
| 1.....   | 61-7417 .....             | BX1721 Baseplate.....                             | 1    |
| 2.....   | 62-3468 .....             | Attachment Tab Assembly with Hole .....           | 2    |
| 3.....   | 101-9302 .....            | Spacer Plate .....                                | 2    |
| 4.....   | 201-0050 .....            | 1/4"-20 x 3/4" Hex Head Bolt, Grade 5, ZP .....   | 1    |
| 5.....   | 201-0192 .....            | #10-32 1/2" Round Slotted Head Screw.....         | 2    |
| 6.....   | 201-0799 .....            | 1/2"-13 x 3-1/4" Hex Head Bolt, Grade 5, ZP ..... | 6    |
| 7.....   | 201-0979 .....            | #12-14 x 1" Self Drilling Screw, ZP.....          | 2    |
| 8.....   | 202-0047 .....            | #10-32 Hex Nut .....                              | 2    |
| 9.....   | 202-0155 .....            | 1/2"-13 Hex Nylon Insert Lock Nut, ZP.....        | 6    |
| 10.....  | 202-0102 .....            | 1/4"-20 Hex Nylon Nut, ZP .....                   | 1    |
| 11.....  | 203-0054 .....            | #10 Lock Washer, ZP .....                         | 2    |
| 12.....  | 207-1045 .....            | Spacer Tube, BX1721 .....                         | 2    |
| 13.....  | 299-0685 .....            | Electrical Bracket.....                           | 1    |
| 14.....  | Existing.....             | Tow Hook & Hardware.....                          | 2    |
| 15.....  | 226-0049(not shown) ..... | Class IV Safety Cables.....                       | 2    |
| 16.....  | 229-0512(not shown) ..... | 1/2" Quicklink, ZP .....                          | 2    |
| 17.....  | 290-0437(not shown) ..... | Black Cap Plug Receiver.....                      | 2    |

**Important:**

Use only genuine factory replacement parts on your baseplate. Do **NOT** substitute homemade or non-typical parts. If a bolt is lost or in need of replacement, for your safety and the preservation of your baseplate, be sure to use a replacement bolt of the same grade (In most cases it will be Grade 5, please reference the parts list above). Replacement parts may be ordered through your nearest Blue Ox® Dealer or Distributor. Failing to follow and/or altering these installation instructions in either installation or required equipment will void the manufacturer's warranty. Towing behind a non-motorized vehicle will void the warranty.



BX1721

2015-18 Chevy Colorado/GMC Canyon (4WD) (Includes Denali)

2017-18 Chevy Colorado ZR2

Installation Instructions

### Chevy Colorado/GMC Canyon Fascia and Bumper Removal:



1. **Canyon Only:** Remove the nine (9) push pins from the fascia cover and set aside.  
**All Models:** Using a T15 Torx, remove the six (6) screws from the top edge of the fascia.



2. Using a T15 Torx, remove the four (4) screws from the edge of the fender flare. Do this on both sides of the vehicle.

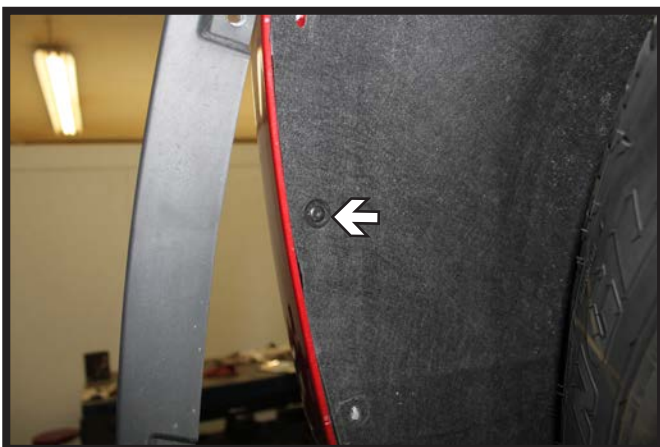

3. Pull out the fender flare and remove the screw behind, using a T15 Torx. Do this on both sides of the vehicle.

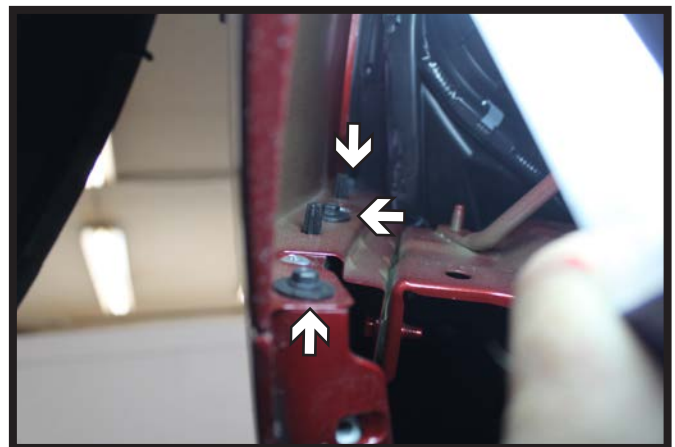

4. Behind the wheel well liner, using a 7MM socket, remove the three (3) screws along the fascia/fender joint. Do this on both sides of the vehicle.

## BX1721

### 2015-18 Chevy Colorado/GMC Canyon (4WD) (Includes Denali) 2017-18 Chevy Colorado ZR2 Installation Instructions

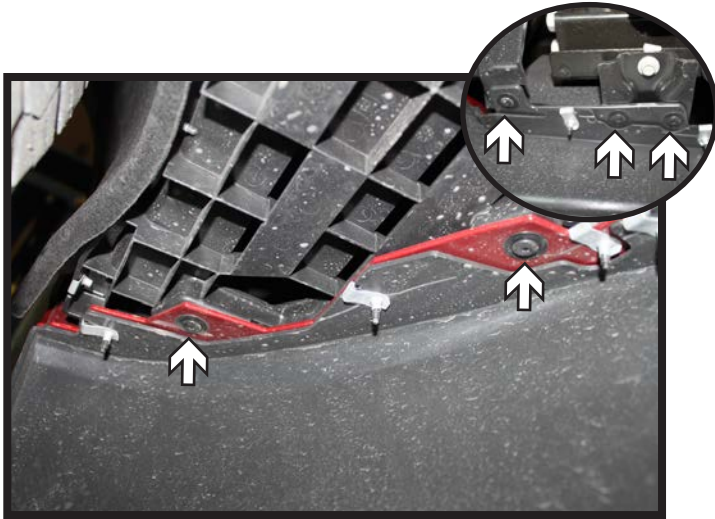

5. Using a T15 Torx, remove the ten (10) screws from the underside edge of the fascia. There are five (5) on each side.



6. Using a 10MM socket, remove the two (2) screws from inside the grille just above the license plate bracket. There is one (1) on each side.

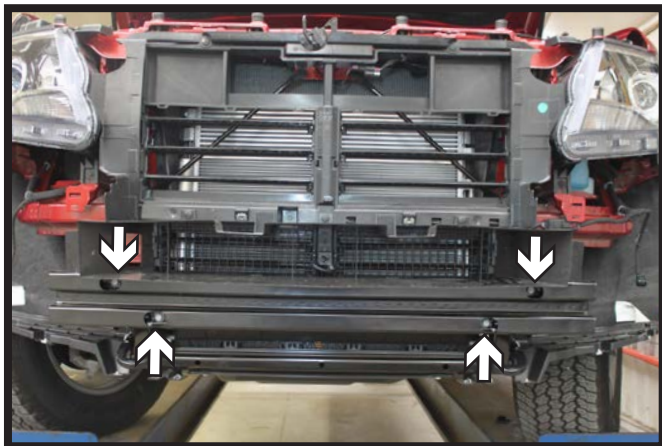

7. Using a 15MM socket, remove the four (4) bolts from the bumper. Set aside for baseplate installation.

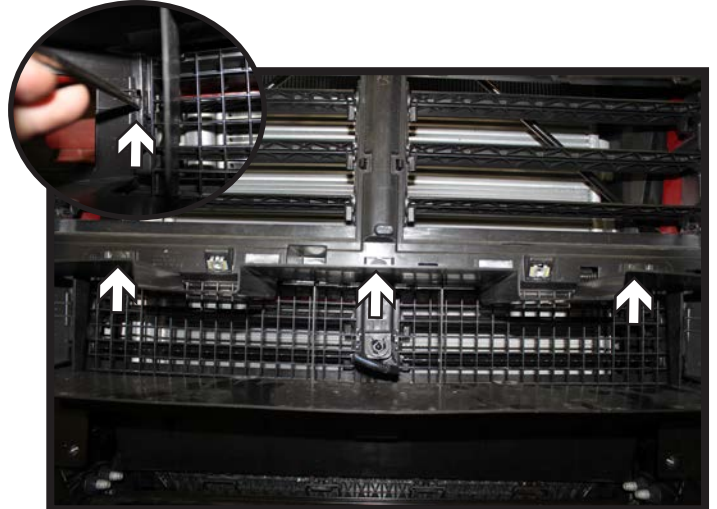

8. Remove the three (3) push pins from across the top of the air baffle. Using a flat blade screwdriver unplug the outer edges (inset) and set the baffle aside for baseplate installation.

BX1721  
2015-18 Chevy Colorado/GMC Canyon (4WD) (Includes Denali)  
2017-18 Chevy Colorado ZR2  
Installation Instructions

**Chevy Colorado ZR2 Fascia and Bumper Removal:**

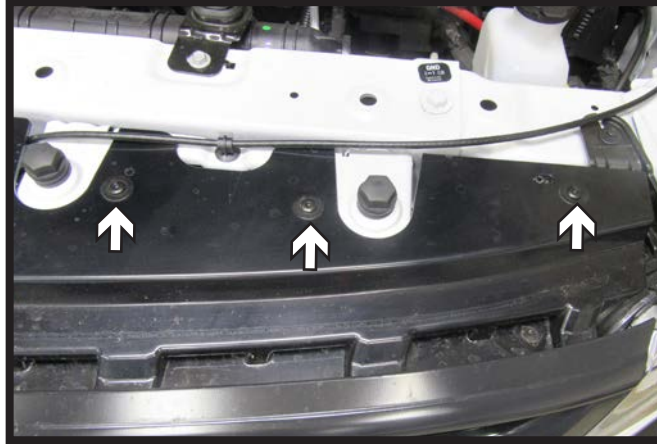

1. Using a T15 Torx, remove the six (6) screws, three (3) on each side, from the top edge of the fascia.

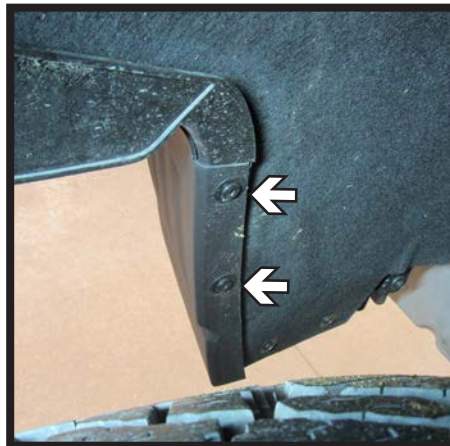
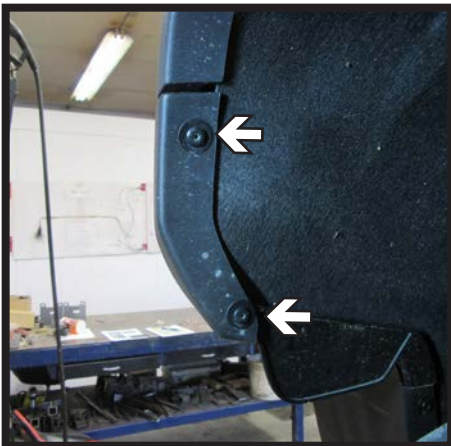

2. Using a T15 Torx, remove the five (5) screws from in front of the tire in the wheel well. Do this on both sides of the vehicle.



BX1721  
2015-18 Chevy Colorado/GMC Canyon (4WD) (Includes Denali)  
2017-18 Chevy Colorado ZR2  
Installation Instructions

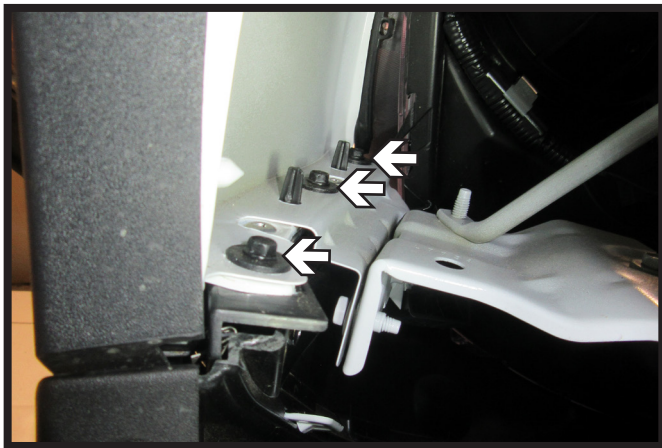

3. Behind the wheel well liner, using a 7MM socket, remove the three (3) screws along the fascia/fender joint. Do this on both sides of the vehicle.



4. Using a 10MM socket, remove the two (2) screws (white) from the grill just above the license plate bracket.

Then using a 10MM socket, remove the one (1) screw (gray) from inside the grill shown in inset. Do this on both sides of the vehicle.

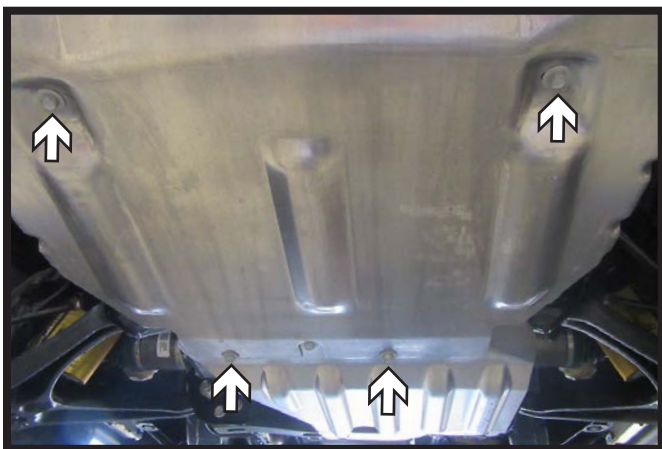

5. Using a 15MM socket, remove the four (4) screws from the belly pan. Remove belly pan and set aside to be reinstalled later.

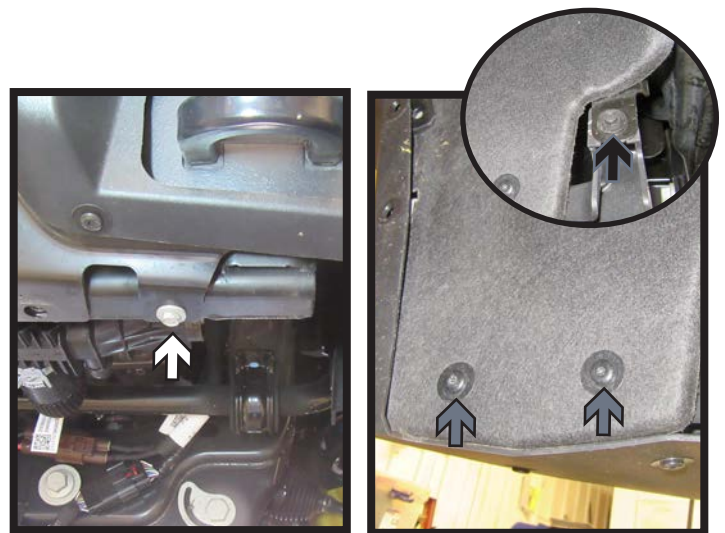

6. Using a 10MM socket, remove the one (1) screw (white) from under the tow hook. Then using a T15 Torx remove the two (2) indicated screws (gray). Using a 7MM socket remove the one (1) screw as indicated in the inset (black). Do this on both sides of the vehicle.

## BX1721

### 2015-18 Chevy Colorado/GMC Canyon (4WD) (Includes Denali) 2017-18 Chevy Colorado ZR2 Installation Instructions



7. Using a flat blade screwdriver unsnap the two (2) clips open on the back side of the fascia. Do this on both sides of the vehicle.

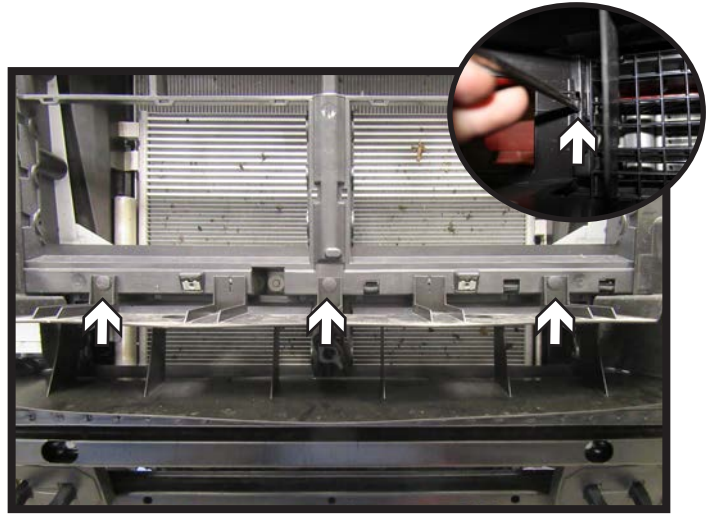

8. Remove the three (3) push pins from across the top of the air baffle. Using a flat blade screwdriver unsnap the outer edges (inset) and set the baffle aside for baseplate installation.

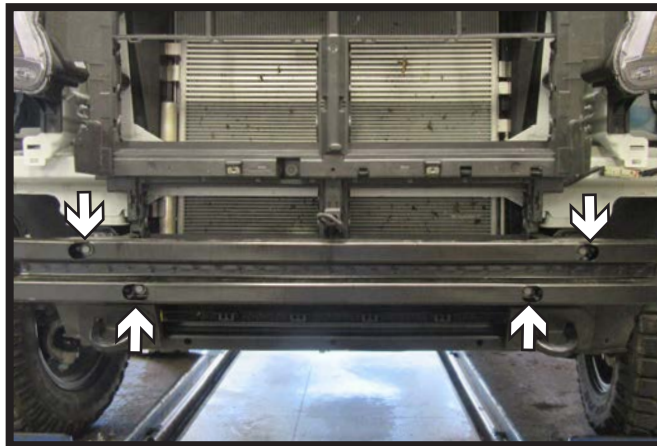

9. Using a 15MM socket, remove the four (4) bolts from the bumper. Set aside for baseplate installation.



BX1721  
2015-18 Chevy Colorado/GMC Canyon (4WD) (Includes Denali)  
2017-18 Chevy Colorado ZR2  
Installation Instructions

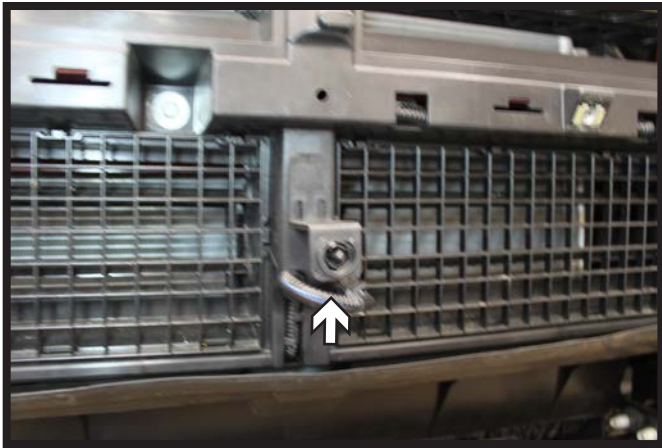

10. Remove the temperature sensor from the factory location.

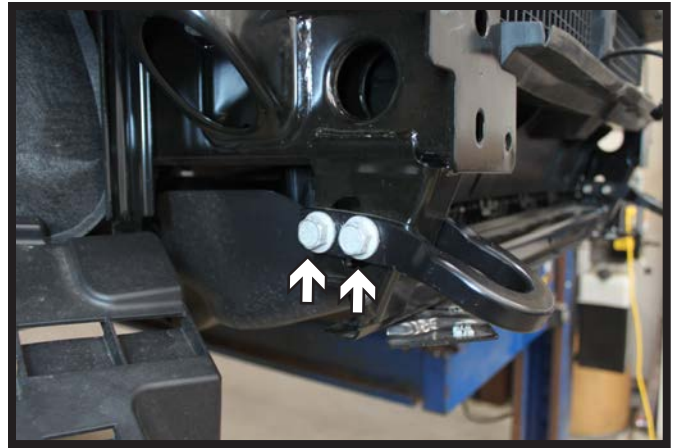

11. Using a 18MM socket/wrench, remove the two (2) bolts from the tow hook. Do this on both sides of the vehicle. Set the hooks and hardware aside.

Chevy ZR2 Models: Remove the foam pieces from the tow hooks first.

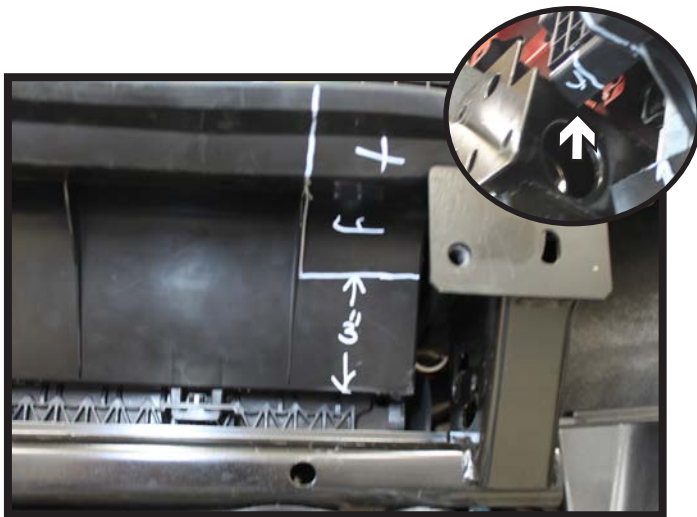

12. Trim the face of the plastic shielding 3" up from the bottom over to the rib. After the front section is removed, trim the upper section behind (inset) for baseplate clearance. Do this on both sides of the vehicle.



13. Tip the baseplate into position on the vehicle.

BX1721  
2015-18 Chevy Colorado/GMC Canyon (4WD) (Includes Denali)  
2017-18 Chevy Colorado ZR2  
Installation Instructions

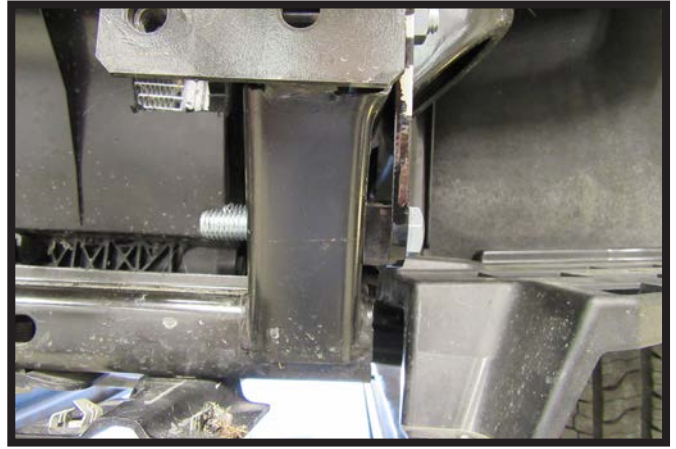

14. **Models w/ Tow Hooks:** Align the baseplate with the tow hook holes. Loosely install the tow hook and existing hardware. Do this on both sides of the vehicle. (Left)

**Models w/o Tow Hooks:** Align the baseplate with the tow hook holes. Install the spacer plate and loosely install the 1/2" hardware. Do this on both sides of the vehicle. (Right)

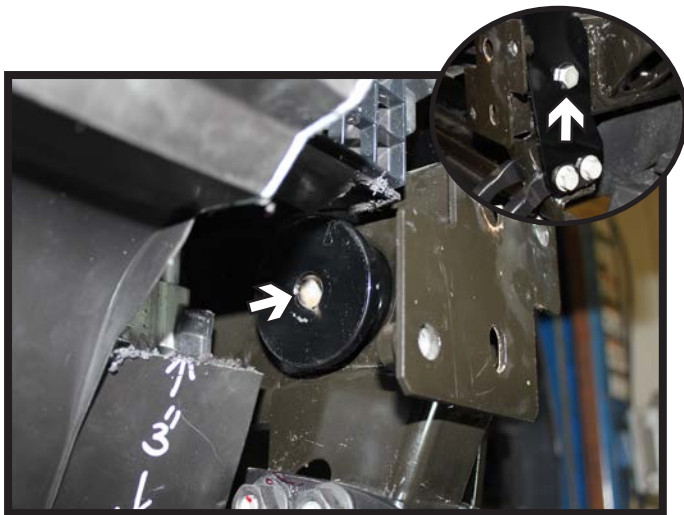

15. On the inside of the frame, install the spacer tube into the existing hole in the frame. Loosely install a 1/2"-13 x 3-1/4" bolt into the hole with a 1/2" lock nut. Do this on both sides of the vehicle.

Lift the baseplate up to its highest position, level and fully tighten all hardware.

\*\* Use Loctite® Red on all bolt threads and tighten all bolts to the appropriate torque.



16. Attach the permanent baseplate safety cables to the provided convenience link on the baseplate. The photo above shows the recommended installation of the cables to frame of vehicle. Additional options may interfere with suggested mounting; in this case, secure the cables to a solid piece of the frame as described in the instructions included with the permanent baseplate safety cables. Be sure the safety cables do not rub against any hoses or moving parts. Do this on **BOTH** sides of the vehicle.



BX1721  
2015-18 Chevy Colorado/GMC Canyon (4WD) (Includes Denali)  
2017-18 Chevy Colorado ZR2  
Installation Instructions

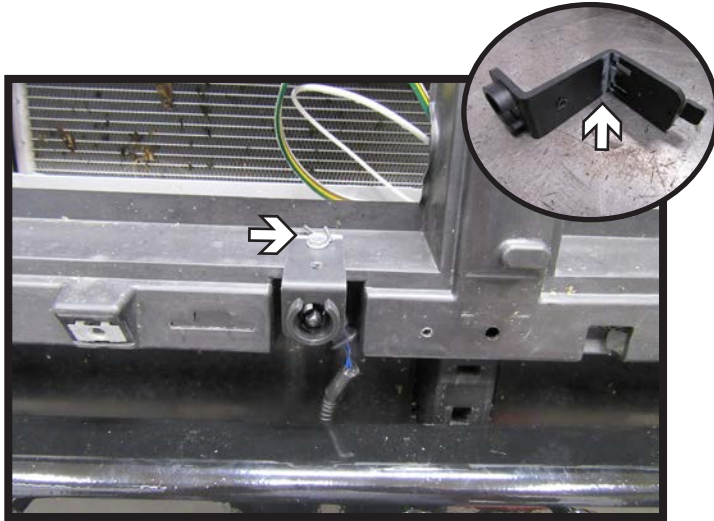

17. Trim the back half of the temperature sensor bracket off (inset). Screw the bracket to the shrouding with the provided self tapping screw.



18. Trim the extension off the backside of the bumper as shown for baseplate clearance. Do this on both sides of the bumper and reinstall on the vehicle.

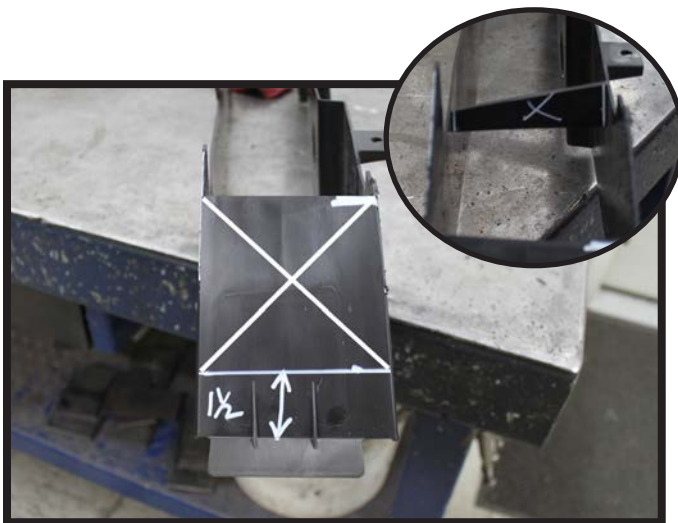

19. Trim off both ends of the air baffle approximately an 1-1/2" up from the front. Also trim out all of the support ribs from inside the baffle (inset). Reinstall the baffle onto the vehicle.

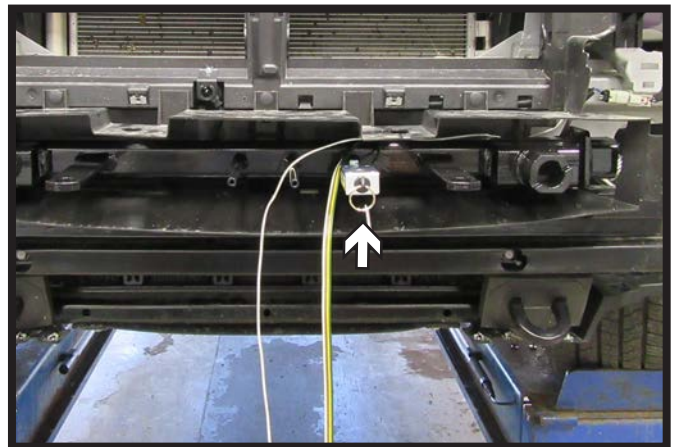

20. **Optional Breakaway:** Attach the breakaway to the baseplate cross-tube with the supplied 1/4" hardware.



BX1721  
2015-18 Chevy Colorado/GMC Canyon (4WD) (Includes Denali)  
2017-18 Chevy Colorado ZR2  
Installation Instructions



21. Reinstall the fascia.



# General Information

1. It is the owner's responsibility to inspect all towing equipment for cracked welds, missing or worn parts and loose bolts before each towing trip. Be sure to use Loctite® Red on all bolts and tighten to the recommended specifications.
2. It is the owner's responsibility to hook up all towing equipment per manufacturer's instructions/recommendations.
3. Remove the attachment tabs when not in use (if applicable).

## Notice To Baseplate Installer

### 1. It is YOUR responsibility to watch for:

- Oil cooler and air conditioner lines
- Electrical wires and hoses
- Missing parts or attaching points on the frame

\*\* If the baseplate is improperly installed and is against a wire or hose, it could cause fluid leaks or electrical shorts some time after the actual baseplate installation.

## Permanent Baseplate Safety Cable Installation

Permanent baseplate safety cables are strongly recommended when towing a vehicle with a tow bar. The principle function of the permanent baseplate safety cables is to prevent the towed vehicle from breaking loose in the event the connection between the frame of the towed vehicle and the baseplate fails or becomes disconnected. The cables must be connected from the baseplate to the frame rail or cross member of the vehicle's frame. The illustrations below show the possible arrangements recommended by Blue Ox®. Each permanent baseplate safety cable must have an adequate weight rating for the towing system. The weight rating of the two (2) cables together will not qualify.

***Do not mount the permanent baseplate safety cables against wires, hoses or brake lines.***

These permanent baseplate safety cables should remain installed as long as the baseplate is installed on the vehicle. Permanent baseplate safety cables are to be used in conjunction with, and NOT a replacement for legally required safety cables attaching the towed vehicle to the towing vehicle.

### Option #1

(Baseplates with Convenience Link Tabs)



### Option #2

(Baseplates with out Convenience Link Tabs)

