

BLACK MODULAR UNIVERSAL ROLL BAR FOR 1/2 TON TRUCKS (GM SILVERADO 14+/FORD F150 15+/DODGE RAM 15+) WITH FULL SIZE CARGO BASKET(WITH RED BRAKE LIGHT)



INSTALLATION INSTRUCTIONS

BLACK MODULAR UNIVERSAL ROLL BAR FOR 1/2 TON TRUCKS (GM SILVERADO 14+/FORD F150 15+/DODGE RAM 15+) WITH FULL SIZE CARGO BASKET(WITH RED BRAKE LIGHT)

PART # WRB-001BK

BLACK MODULAR UNIVERSAL ROLL BAR FOR 1/2 TON TRUCKS (GM SILVERADO 14+/FORD F150 15+/DODGE RAM 15+) WITH FULL SIZE CARGO BASKET(WITH RED BRAKE LIGHT)

Before Installation

- Please read the instruction completely for easy installation, which will also help you to avoid scratches or other potential damages to your appealing car.
- The figures here are for reference only and may have differences with the actual product you received, however they share the same assembly way.

Care and Cleaning

- Mild soap may be used also to clean the product.
- Please periodically check and retighten all the hardware and clean the investment for a refresh look.

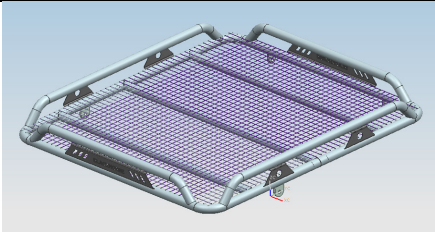
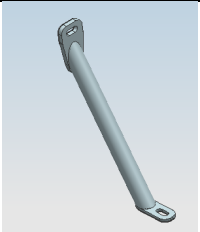
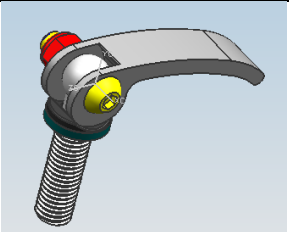
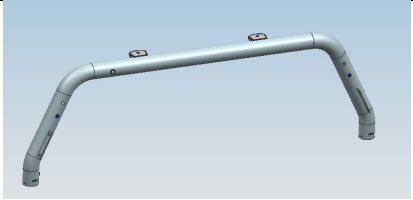
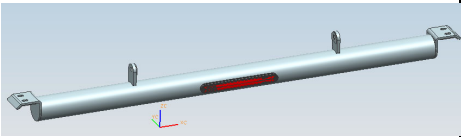
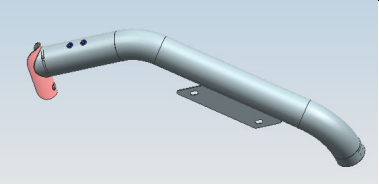

Parts list

NO.	QTY	PICTURE	NO.	QTY	PICTURE	NO.	QTY	PICTURE
	1			2			6	
		Luggage frame			Luggage frame bracket			M12 quick release
	1			1			1	
		Main tube			Middle tube			Side tube-L

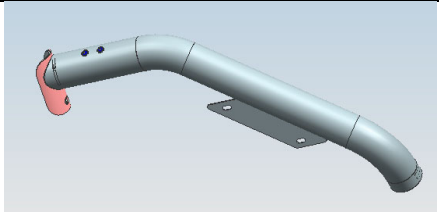
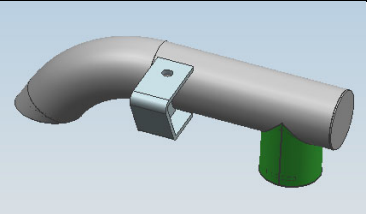
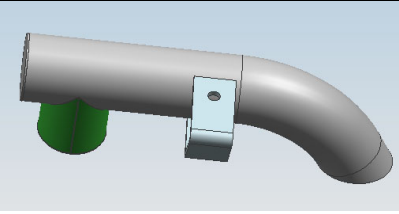
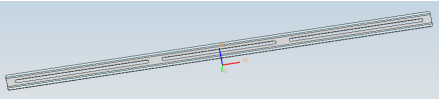
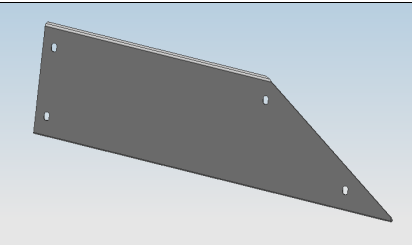
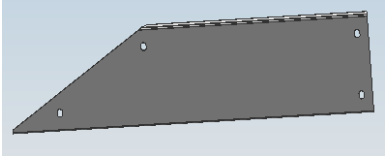
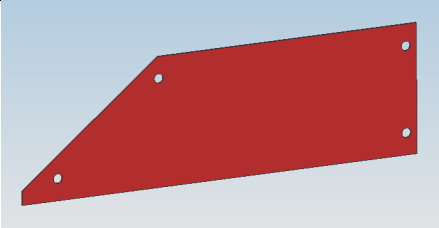
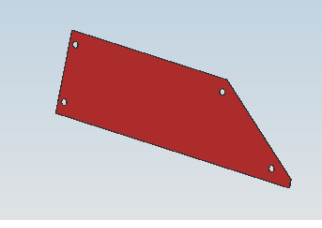
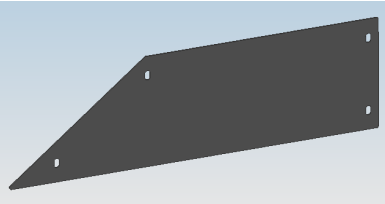
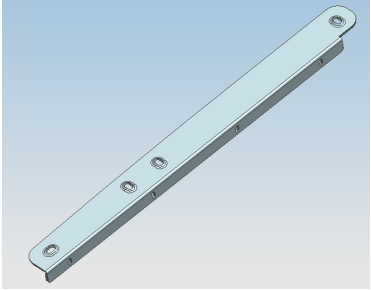
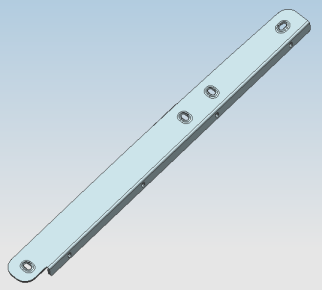
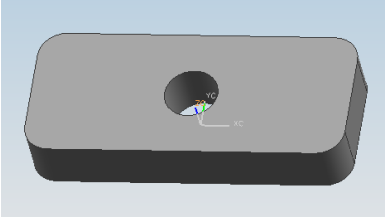
BLACK MODULAR UNIVERSAL ROLL BAR FOR 1/2 TON TRUCKS (GM SILVERADO 14+/FORD F150 15+/DODGE RAM 15+) WITH FULL SIZE CARGO BASKET(WITH RED BRAKE LIGHT)

1	 <p>Side tube-R</p>	1	 <p>Short side tube-L</p>	1	 <p>Short side tube-R</p>
1	 <p>Connecting plate</p>	1	 <p>Decoration plate-L</p>	1	 <p>Decoration plate-R</p>
1	 <p>Red decoration plate-L</p>	1	 <p>Red decoration plate-R</p>	2	 <p>Decoration plate backboard</p>
1	 <p>L-bracket</p>	1	 <p>R-bracket</p>	2	 <p>Block</p>

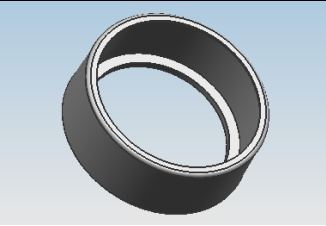
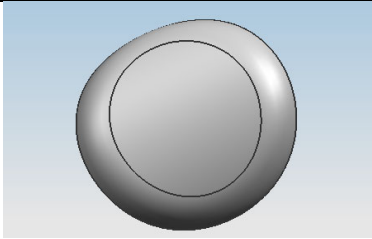
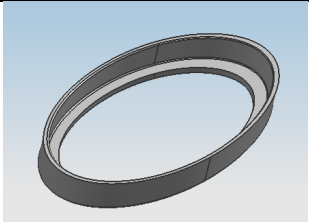
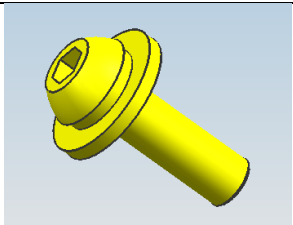
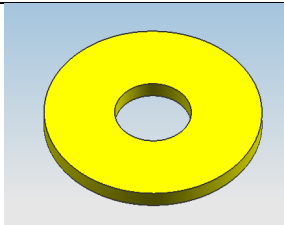
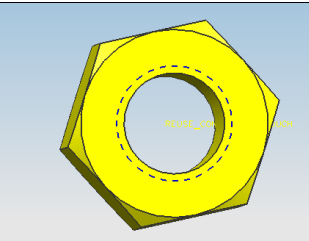
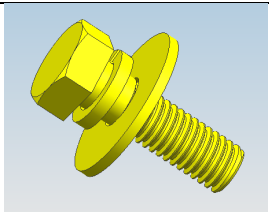
BLACK MODULAR UNIVERSAL ROLL BAR FOR 1/2 TON TRUCKS (GM SILVERADO 14+/FORD F150 15+/DODGE RAM 15+) WITH FULL SIZE CARGO BASKET(WITH RED BRAKE LIGHT)

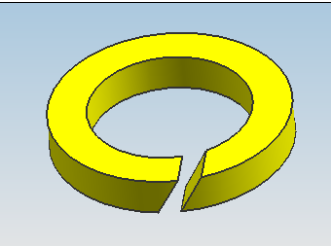
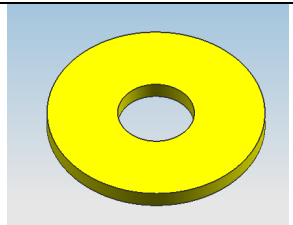
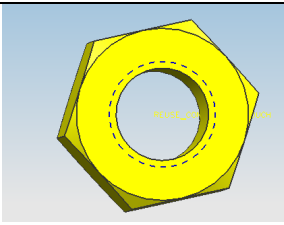
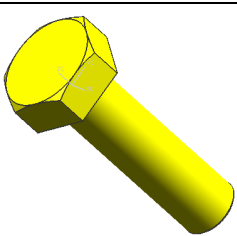
6	 <p>Gum cover 1</p>	2	 <p>Rubber plug</p>	2	 <p>Gum cover 2</p>
8	 <p>Button head allen bolts M6_20</p>	8	 <p>Flat washer D6</p>	8	 <p>Hex nut M6</p>
6	 <p>Button head allen bolts M8_25</p>	2	 <p>Button head allen bolts M8_30</p>	2	 <p>Spring washer D8</p>
4	 <p>Flat washer D8</p>	2	 <p>Hex nut M8</p>	8	 <p>Hex nut M10_35</p>

BLACK MODULAR UNIVERSAL ROLL BAR FOR 1/2 TON TRUCKS (GM SILVERADO 14+/FORD F150 15+/DODGE RAM 15+) WITH FULL SIZE CARGO BASKET(WITH RED BRAKE LIGHT)

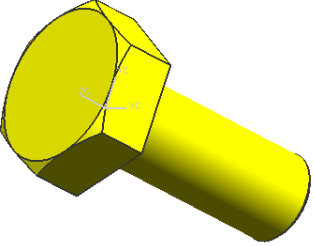
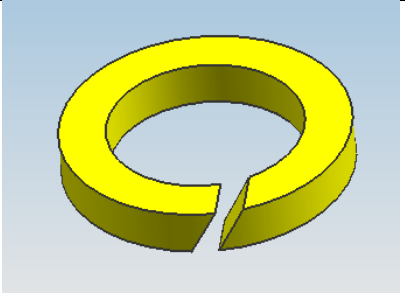
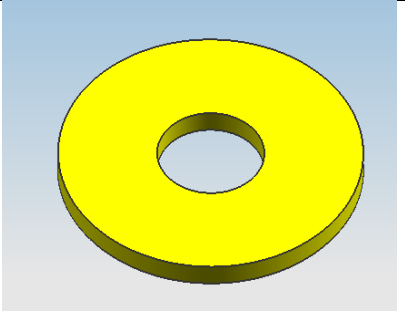
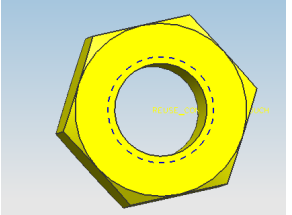
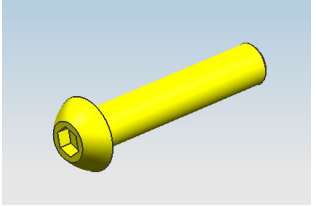
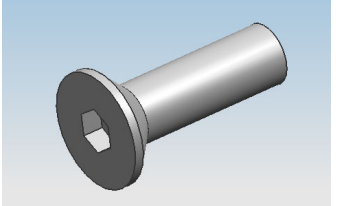
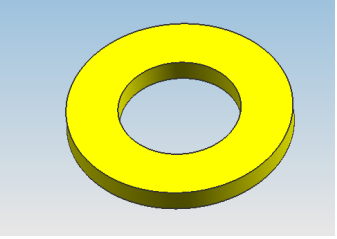
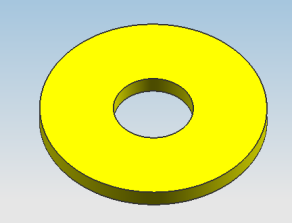
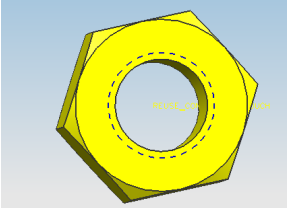
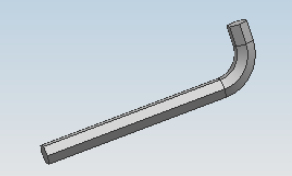
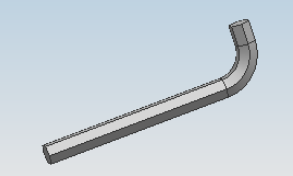
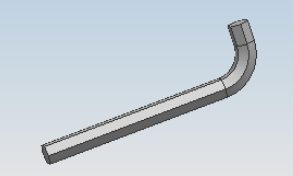
2	 <p>Hex nut M10_25</p>	10	 <p>Spring washer D10</p>	18	 <p>Flat washer D10</p>
8	 <p>Hex nut M10</p>	2	 <p>Hexagon socket head screw M12*40</p>	8	 <p>Hexagon socket head screw M12*40</p>
2	 <p>Flat washer D12</p>	6	 <p>Flat washer D12</p>	6	 <p>Hex nut M12</p>
1	 <p>Allen wrench S=8</p>	1	 <p>Allen wrench S=4</p>	1	 <p>Allen wrench S=5</p>

Installation pictures

MR roll bar

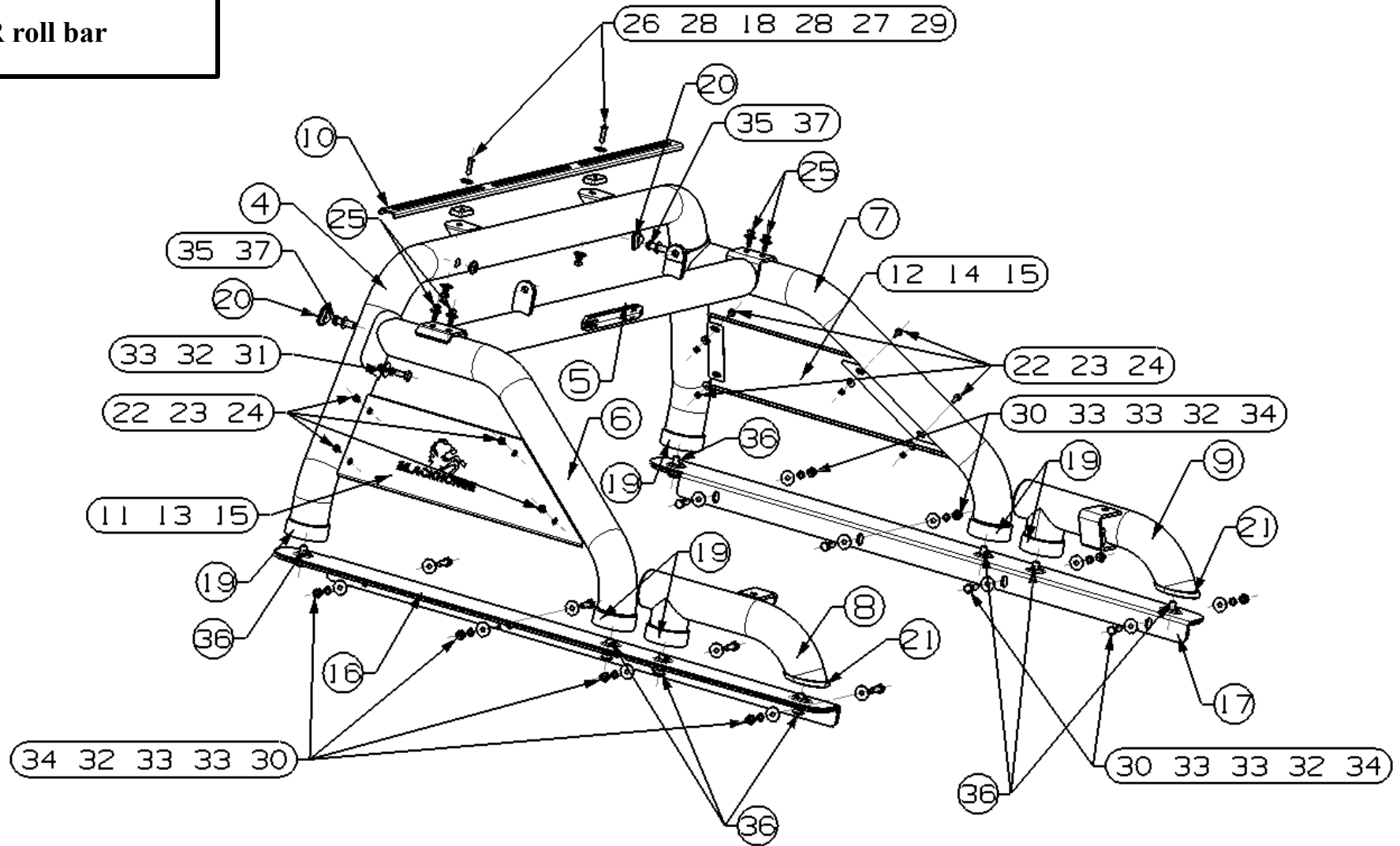

MR cargo basket

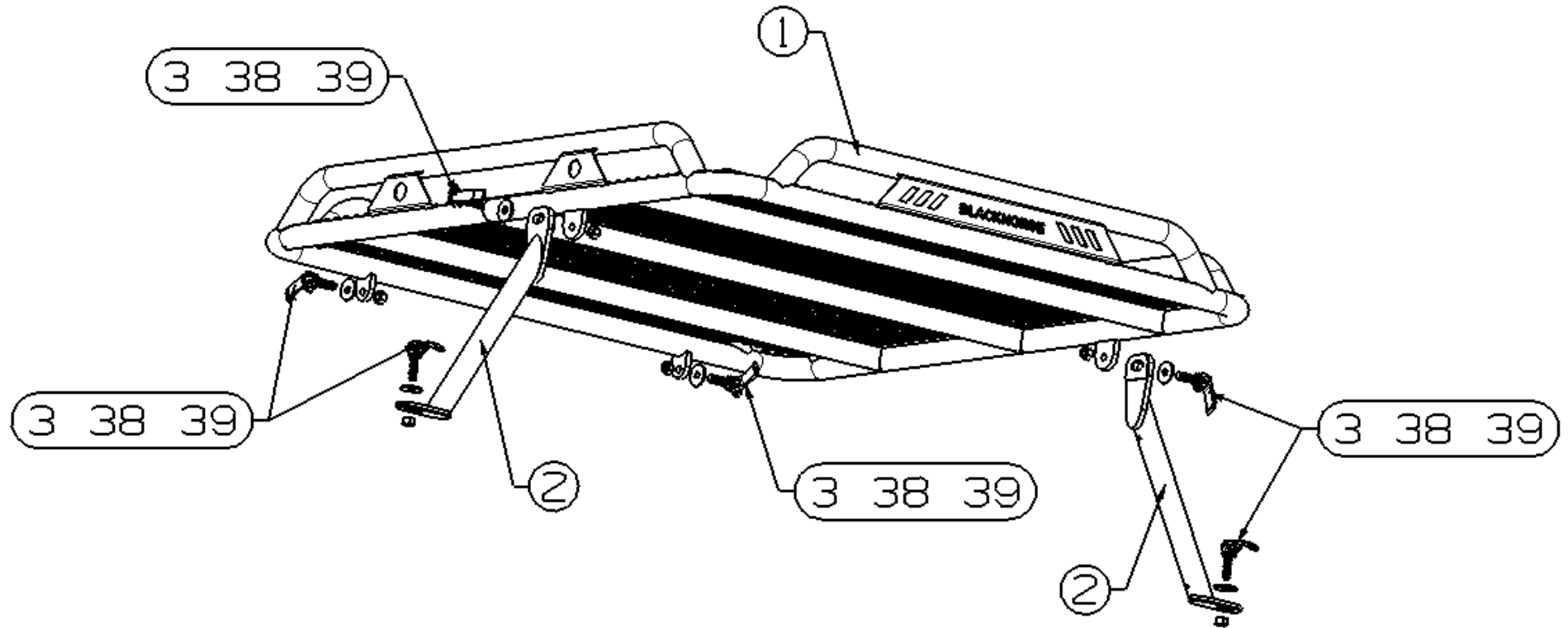

BLACK MODULAR UNIVERSAL ROLL BAR FOR 1/2 TON TRUCKS (GM SILVERADO 14+/FORD F150 15+/DODGE RAM 15+) WITH FULL SIZE CARGO BASKET(WITH RED BRAKE LIGHT)

Step 1: Check all the contents are available in accordance with the above list.

Step 2: Use standard parts and to connect with . Do not tighten the bolt.

Step 3: Use standard parts to connect with . Do not tighten the bolt.

Step 4: Use standard parts to connect and with . Do not tighten the bolt.

Step 5: As MR ROLL BAR figure shows, assemble gum covers to the corresponding position.

Step 6: Place the MR roll bar and tubes on brackets , then use standard part to connect. Lock all the standard parts after adjust the position.

Step 7: Put roll bar on the truck in an appropriate place. And use pen to mark the holes. Then remove the roll bar and drill the holes for

installation. Put the roll bar back and use standard to fasten.。

Step 8: Use standard parts and block to connect Main tube with Connecting plate . Do not tighten the bolt.

Step 9: Use standard parts to connect Luggage frame bracket with Luggage frame . Do not tighten the bolt.

Step 10: Place MR cargo basket on MR roll bar. Then use standard parts to connect and . Lock all the standard parts after adjust the position.

Step 11: Assemble rubber plug to Main tube . Check all bolts whether they have been fastened. Packing up and Installation completed.

NOTE

Any damages and losses caused by improper installation and application, goes beyond our quality warranty.

BLACK MODULAR UNIVERSAL ROLL BAR FOR 1/2 TON TRUCKS (GM SILVERADO 14+/FORD F150 15+/DODGE RAM 15+) WITH FULL SIZE CARGO BASKET(WITH RED BRAKE LIGHT)

Assemble Pic.



Learn more about truck bed accessories we have.