



INSTALLATION INSTRUCTIONS

**OE STYLE RUNNING BOARD FOR TOYOTA
HIGHLANDER 14-18
PART # RTOHI-14**

● **Precautions:**

≡ Figures here are for reference only, may have difference with the actual product that you received. However, they share the same assembly way.

≡ Please read this instruction carefully for easy installation. Protect your vehicle from any scratches or any potential damage while installing.

≡ check and retighten all the connecting accessories periodically and also clean the running board for a refresh look.







Installation tools: Sleeve component











● **Function and features**

≡ Easy mounting. No drilling on the chassis, original holes installing.

≡ Elegance design, perfect match to chassis and high quality.

● **Parts list**

NO.	Name	Qty	Picture
①	Running board	2	
②	Front bracket(L)	1	
③	Middle bracket(L)	1	
④	Rear bracket(L)	1	
⑤	Front bracket(R)	1	
⑥	Middle bracket(R)	1	
⑦	Rear bracket(R)	1	

NO.	Name	Qty	Specification	Pictures
⑧	T-bolt	2		
⑨	Square neck bolt	2	M12X4 5	
⑩	Hex nut	2	M12	
⑪	Spring	1		
⑫	Hex bolt	12	M8*20	
⑬	Flat washer	12	M12	
⑭	Hex bolt	2	M10X4 0	
⑮	Hex nut	12	M6	
⑯	Shaped nut	1	M8	
⑰	Shaped nut	12	M8	
⑱	Flat washer	1	M8	

● **Installation steps**

1. Install bracket in left side: (The plastic plate with notch is the front of this running board.)

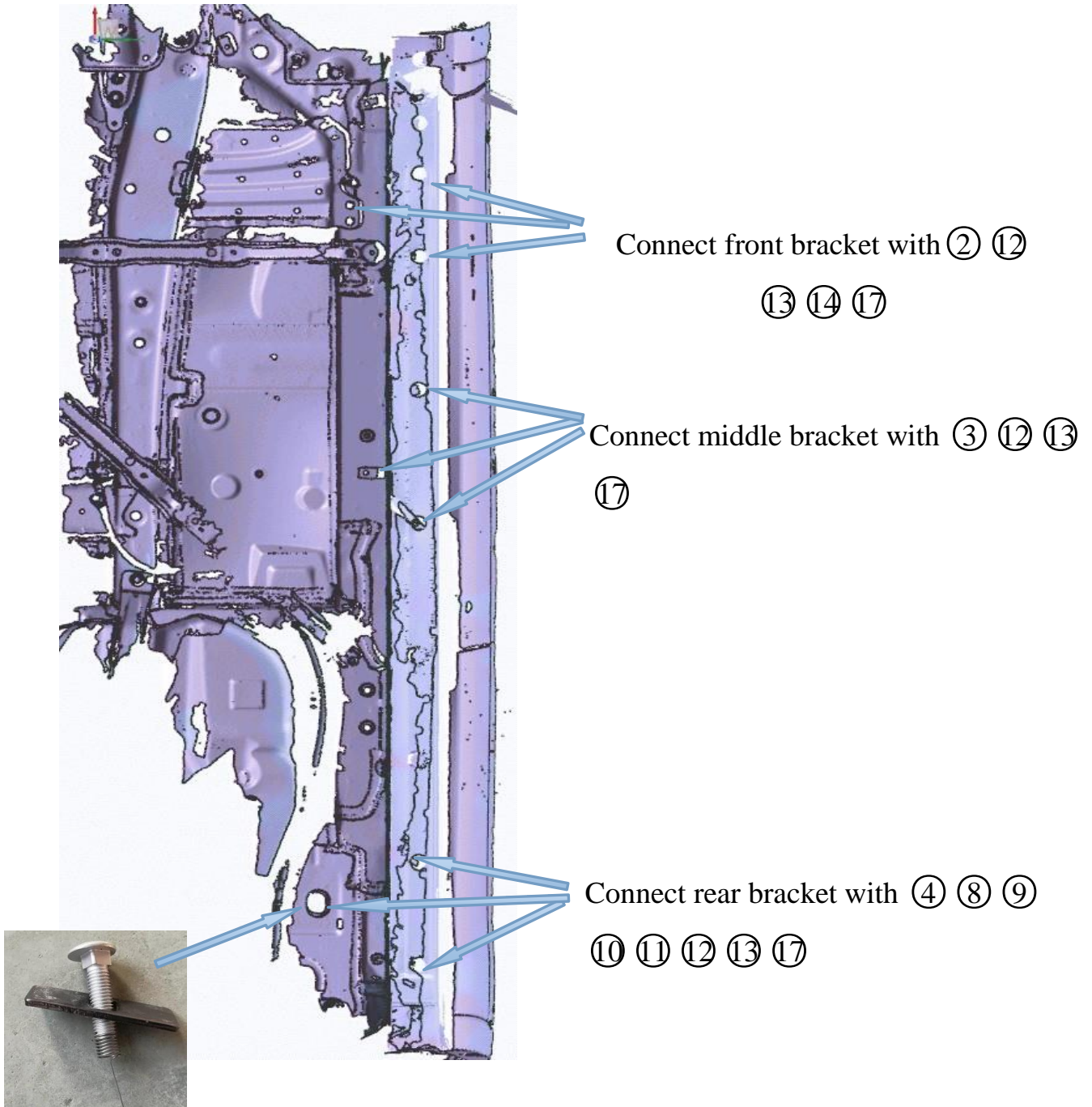

(The way to install T-shaped bolt combo: install the square plate into the square neck bolt, then screwing in the spring. Screwing down the spring after inserted the T-shaped combo into the chassis hole.)

2. Install bracket in right side:

Install front bracket with

⑤ ⑫ ⑬ ⑭ ⑰

Install middle bracket with

⑥ ⑫ ⑬ ⑰

(Due to the position asymmetry between the L&R middle brackets, move the panel towards the front cab side while installing. Using fixed bolt in running boards and remove the nut and install middle bracket.

Install rear bracket with

④ ⑧ ⑨ ⑩ ⑪ ⑫ ⑬ ⑰

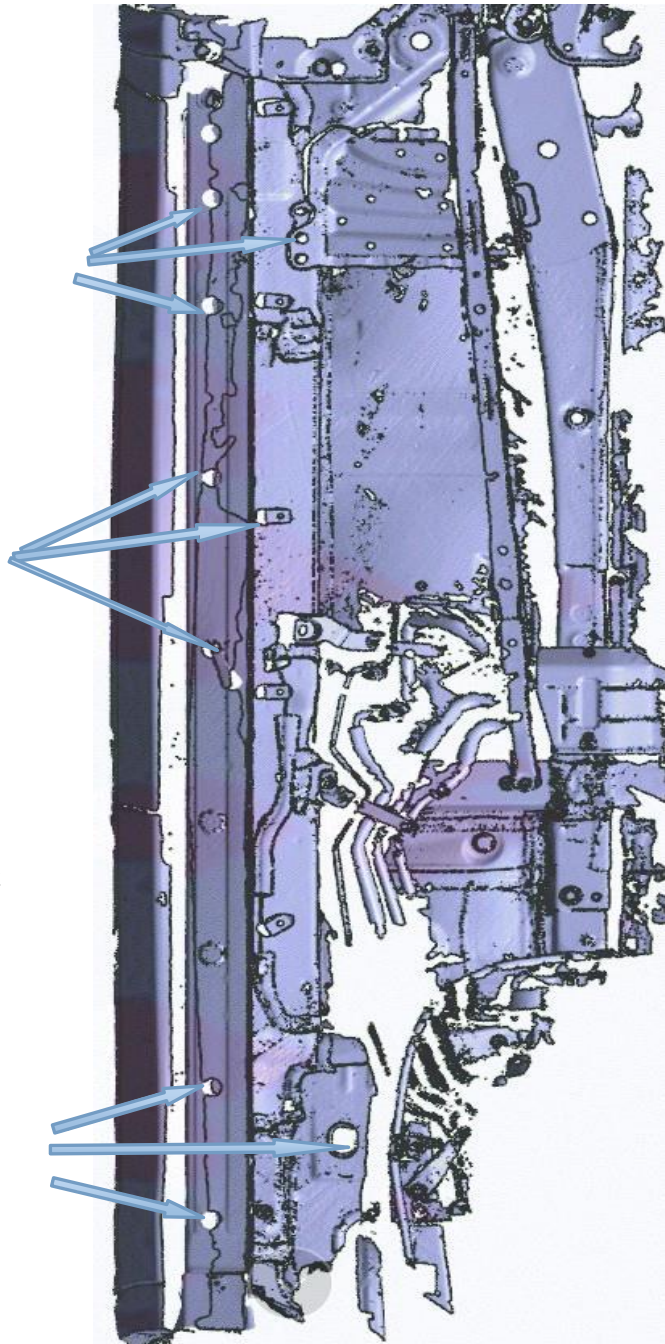

3. Adjust the running board to appropriate position, and then tighten all the bolts.

● **Installation complete**

