









ATLAS ROLL BAR WITH CARGO BASKET

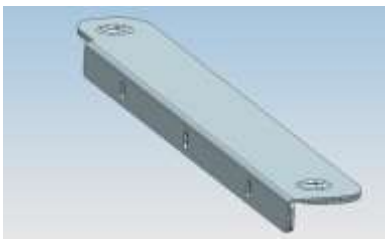

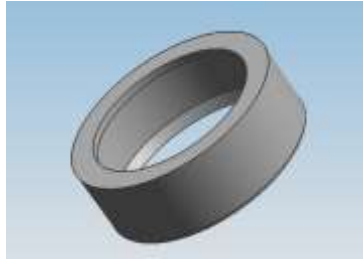

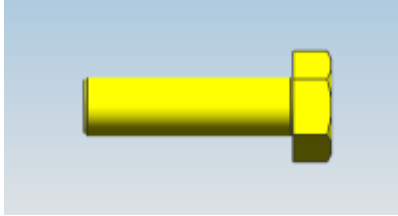
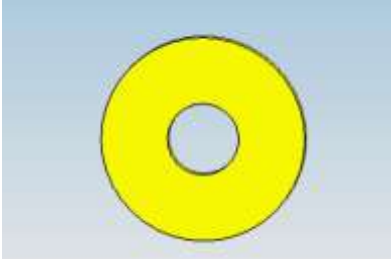
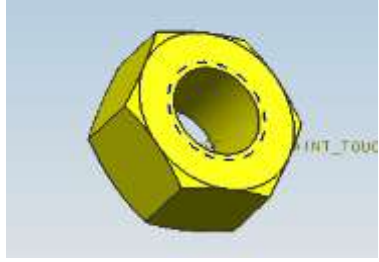
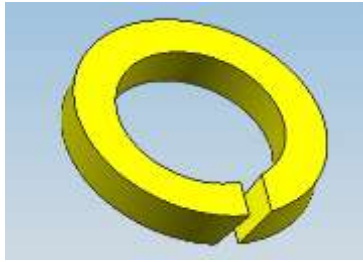
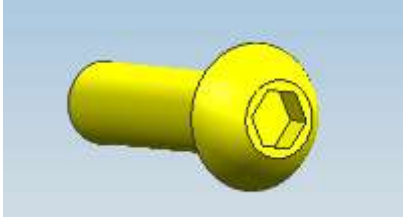
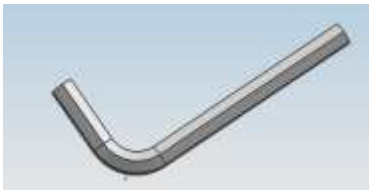
Parts list

NO.	QTY	PIC	NO.	QTY	PIC
①	1	A grey metal side plate with a trapezoidal shape, featuring a horse logo and the word 'BLACKHORSE' in the center.	②	1	A grey metal side plate, mirror image of the left side plate, with a horse logo and the word 'BLACKHORSE' in the center.
③	1	A grey metal side tube with a curved shape, featuring a red end cap.	④	1	A grey metal side tube, mirror image of the left side tube, featuring a red end cap.
⑤	1	A red plastic plate with a trapezoidal shape, matching the side plate.	⑥	1	A red plastic plate, mirror image of the left plastic plate, matching the side plate.
⑦	2	A black metal back plate with a trapezoidal shape.	⑧	1	A silver metal roof rack with a rectangular frame and a central support.
⑨	1	A long, narrow metal connect plate with a textured surface.	⑩	1	A grey metal main tube with a curved shape, featuring a red end cap.
⑪	1	A black metal connect bracket with a trapezoidal shape and a mounting hole.	⑫	1	A black metal connect bracket, mirror image of the left connect bracket, with a mounting hole.

## INSTALLATION INSTRUCTIONS

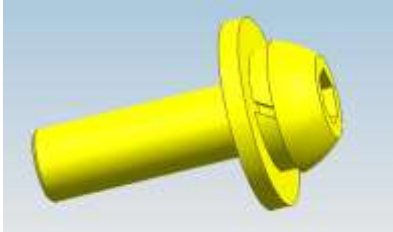
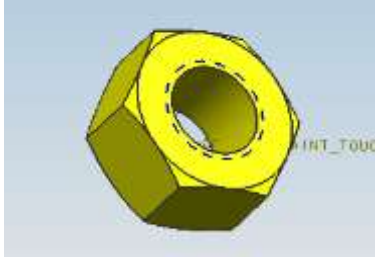
⑬	1		⑭	1	
		Bracket (L)			Bracket (R)
⑮	2		⑯	4	
		Rubber Plug			Gum Cover
⑰	2		⑱	6	
		Connect Bracket 1 (L&R)			10mmx35mm Hex Nut
⑲	12		⑳	6	
		10mm Large Washer			10mm Hex Nut
㉑	6		㉒	2	
		10mm Split Lock Washer			12mmX40MM Socket Cap Screw
㉓	1		㉔	2	
		Hex Wrench S=8			12mm Flat Washer

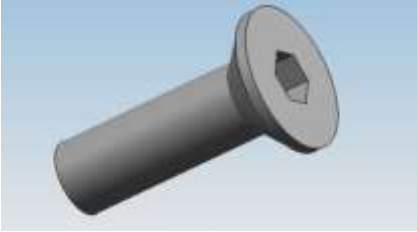
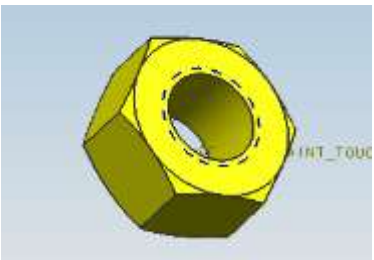
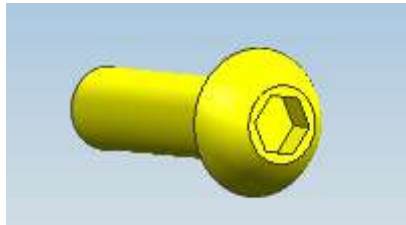
## INSTALLATION INSTRUCTIONS

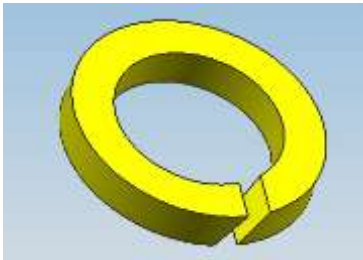
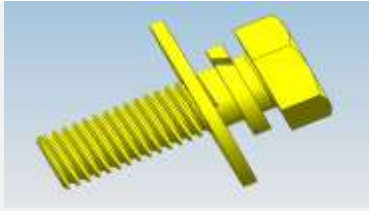
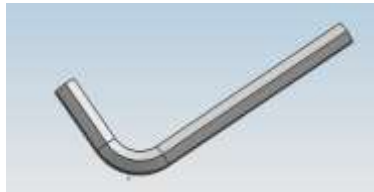
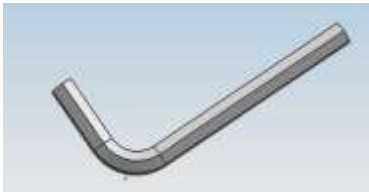
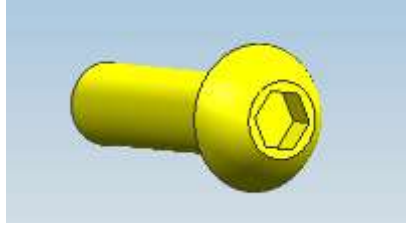
(25)	8	 <p>6mmx20mm Combined Screw</p>	(26)	8	 <p>6mm Hex Nut</p>
(27)	8	 <p>6mm Large Washer</p>	(28)	4	 <p>12mmx40mm Counter Sunk Head Screw</p>
(29)	6	 <p>8mm Hex Nut</p>	(30)	2	 <p>8mmx30mm Socket Cap Screw</p>
(31)	8	 <p>8mm Large Washer</p>	(32)	2	 <p>8mm Split Lock Washer</p>
(33)	14	 <p>8mmx25mm Combined Bolt</p>	(34)	1	 <p>Hex Wrench S=5</p>
(35)	1	 <p>Hex Wrench S=4</p>	(36)	2	 <p>10mmx25mm Socket Cap Screw</p>

## INSTALLATION INSTRUCTIONS

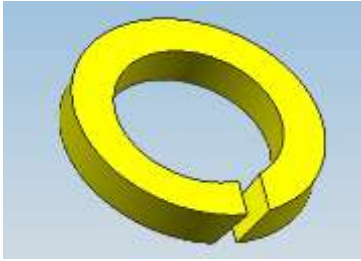
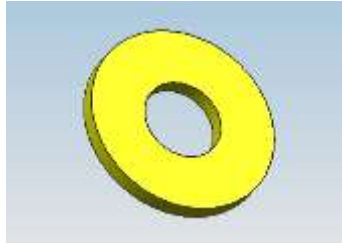
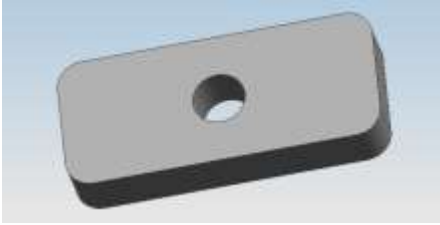
(37)	2	 <p>10mm Split lock Washer</p>	(38)	2	 <p>10mm Large Washer</p>
(39)	2	 <p>Connect Plate</p>	(40)		

### INSTALLING PICTURE

