



INSTALLATION INSTRUCTIONS







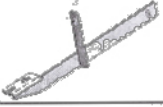

Running Boards Mazda CX9

PART# PR-CX9

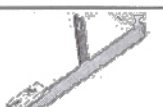
Attention:

- Please read this installation menu before installing this part. Protect your car properly in case there is any scratch might have.
- You may need to periodically to re-tighten all hardware for safety use after installation.
- Installation pictures are only for your referepce, there might be some differences between pictures and real parts but no affect for your fitting.

PART LIST

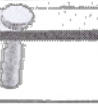
NO.	NAME	QTY	REMARK	NO.	NAME	QTY	REMARK
①	Front Bracket(left)	2		⑩	Spring Washer	8	Φ10
②	Middle Bracket (left)	2		⑪	Hexagon Nut	8	M10
③	Rear Bracket (left)	2		⑫	T Bolt 3	2	M8*35 
④	Front Fitting Kit	2		⑬	Large Washer	2	φ8*25*2.0
⑤	Middle Fitting Kit	2		⑭	Spring Washer	2	φ8
⑥	Rear Fitting Kit	2		⑮	Hexagon Nut	2	M8
⑦	T Bolt 1	4	M10*35 	⑯	Hexagon Nut with Flange	8	M8
⑧	T Bolt 2	4	M10*35 	⑰	Hexagon Bolt with Flange	8	M8*20
⑨	Large Washer	8	φ10*30*2.5				

It is the same way to install both sides.
Here are the left brackets installations.

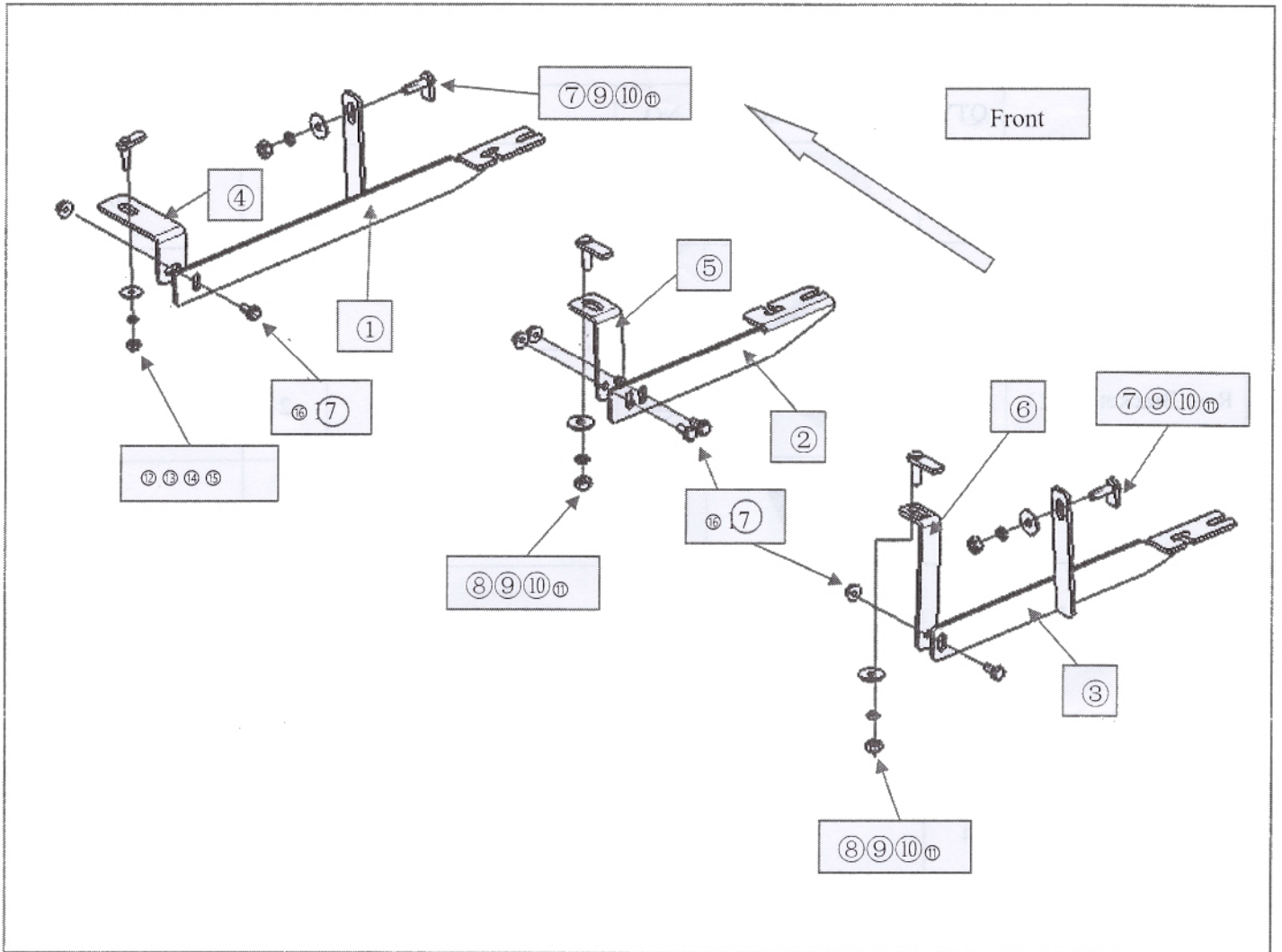

Disclaimer: Caused due to improper installation initiates some related problem and losses, are beyond our company's quality assurance.

Check out the collection of running boards and step bars we offer.