



Running Board

PART#: PINI79

**Fits: 2013
2014 2021**

**2021 Nissan Pathfinder
Infiniti QX60 Nissan Pathfinder**



REMOVE CONTENTS FROM BOX. VERIFY ALL PARTS ARE PRESENT.



READ INSTRUCTIONS CAREFULLY BEFORE STARTING INSTALLATION.



(JjjJj) DO NOT OVER TORQUE. STANDARD OPERATING LOAD FOR TIGHTEN BODY MOUNT NUTS & BOLTS VARIES FROM 45 TO 65 FOOT POUND.



Cutting Not Required

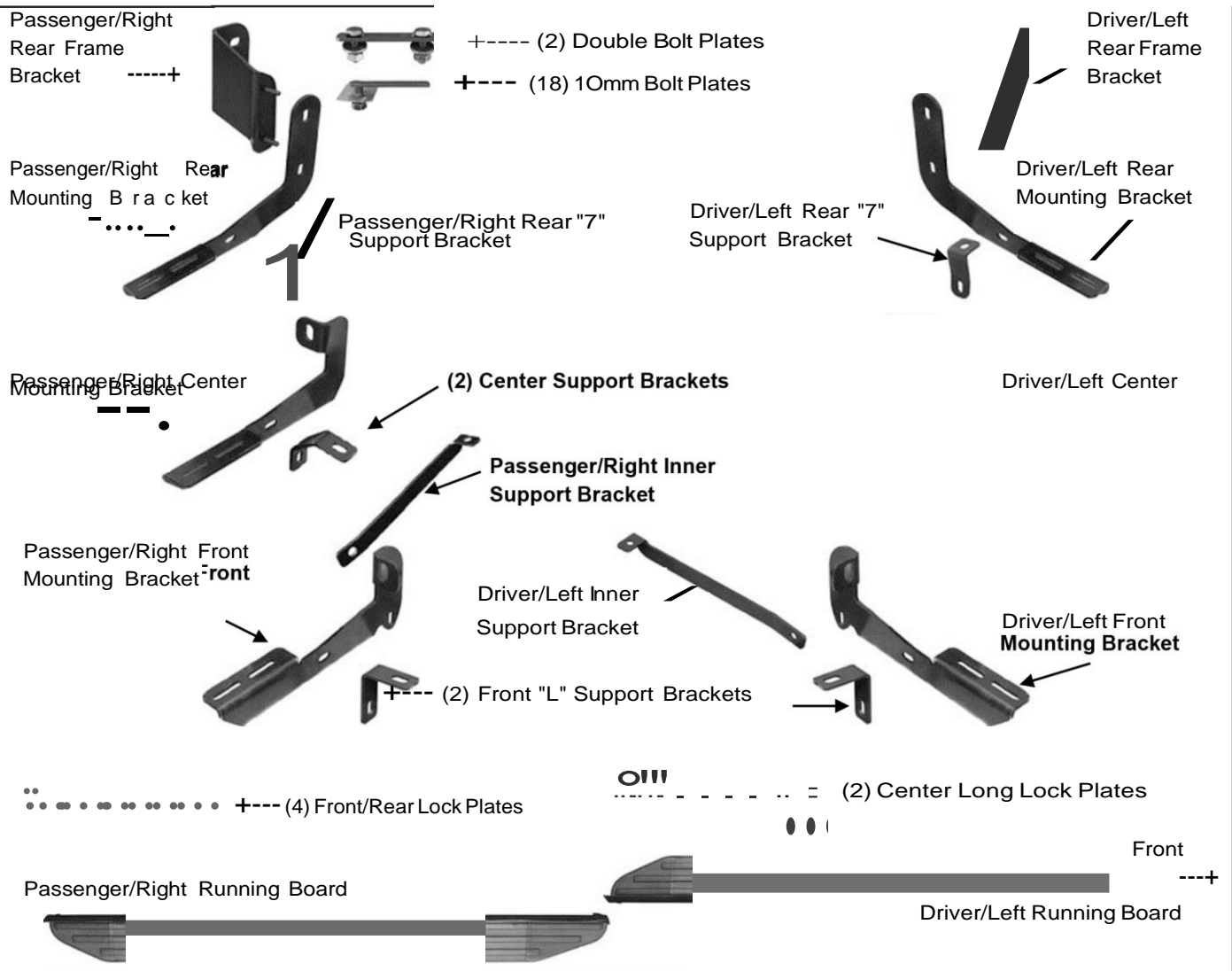


Drilling Not Required

POLISHED STAINLESS STEEL - LIMITED LIFETIME
POWDER COATED BLACK - 3 YEARS

PARTS LIST:

Qty	Part Description	Qty	Part Description
1	Driver/Left Running Board	4	Front and Rear Locking Plates
1	Passenger/Right Running Board	2	Long Center Locking Plates
1	Driver/Left Front Mounting Bracket	2	10mm Double Bolt Plates
1	Passenger/Right Front Mounting Bracket	18	10mm Low Profile Single Bolt Plates
1	Driver/Left Front Long Inner Support Bracket	18	10mm Plastic Retainers
1	Passenger/Right Front Short Inner Support Bracket	22	10mm x 27mm OD x 3mm Flat Washers
2	Front "L" Outer Support Brackets	22	10mm Lock Washers
1	Driver/Left Center Mounting Bracket	22	10mm Hex Nuts
1	Passenger/Right Center Mounting Bracket	8	8-1.25mm x 30mm Hex Bolts
2	Center Support Brackets	20	8mm x 28mm OD x 3mm Flat Washers
1	Driver/Left Rear Frame Mounting Bracket	12	8mm Lock Washers
1	Passenger/Right Rear Frame Mounting Bracket	12	8mm Hex Nuts
1	Driver/Left Rear Mounting Bracket	12	6-1.0mm x 20mm T-Bolts
1	Passenger/Right Rear Mounting Bracket	12	6mm x 22mm OD x 2mm Flat Washers
1	Driver/Left Rear "7" Outer Support Bracket	12	6mm Lock Washers
1	Passenger/Right Rear "7" Outer Support Bracket	12	6mm Hex Nuts



INSTALLATION PROCEDURE

1. Start installation on the passenger side of the vehicle. Locate and remove the (2) rubber plugs in the bottom of the outer frame channel closest to the front wheel opening, (Figure 1).
2. Select (2) 10mm Bolt Plates and (2) 10mm Plastic Retainers, (Figure 2A). Partially thread the Retainers onto the Bolt Plates. NOTE: The Plastic Retainer is designed to help hold the Bolt Plate in place during Bracket installation.
3. Insert (1) Bolt Plate into the first-forward hole with the plate pointed toward the rear of the vehicle, (Figure 2B). Thread the Plastic Retainer down tight against the body panel. Repeat to install the next Bolt Plate into the second hole with the Plate pointed toward the front of the vehicle, (Figure 3). IMPORTANT: The Plates on the (2) Bolt Plates must be pointed toward each other, (Figure 3).

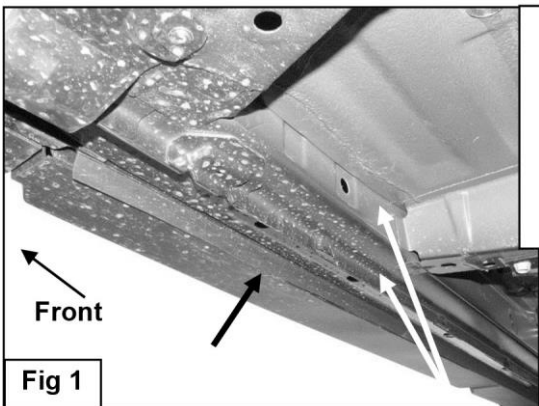


Fig 1
Passenger side front mounting location pictured from below. Remove (3) rubber plugs from factory holes

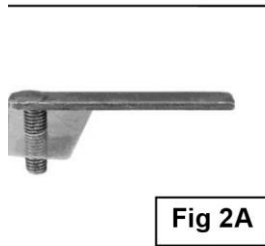


Fig 2A

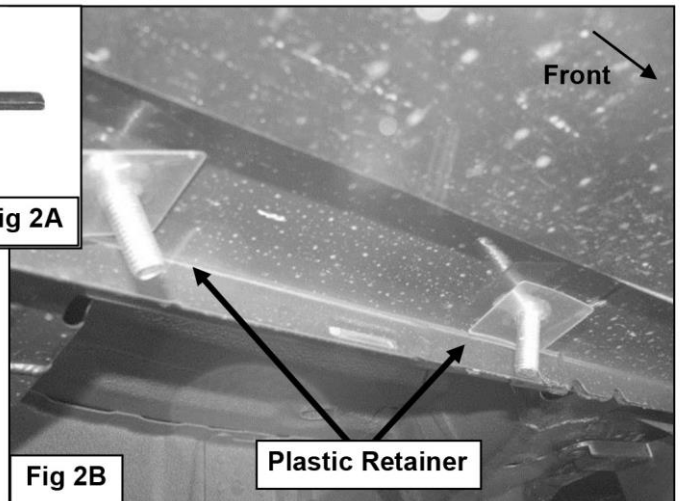
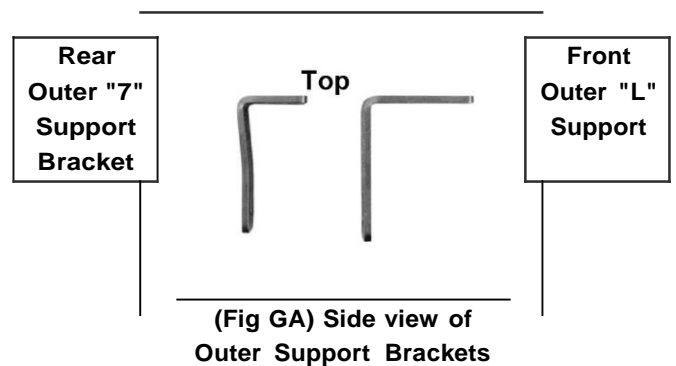
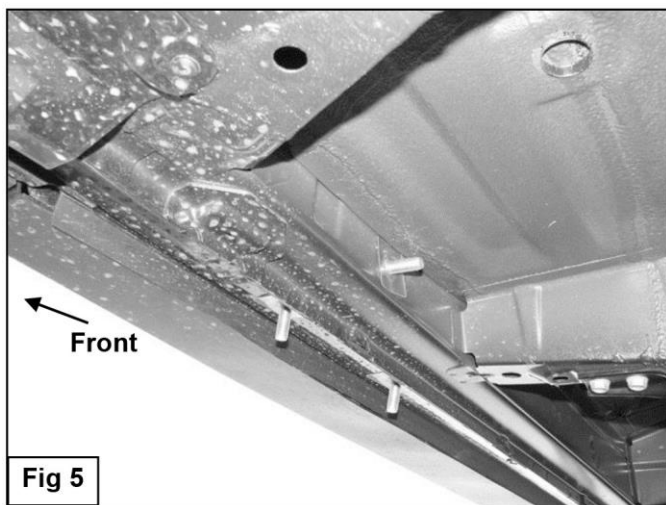
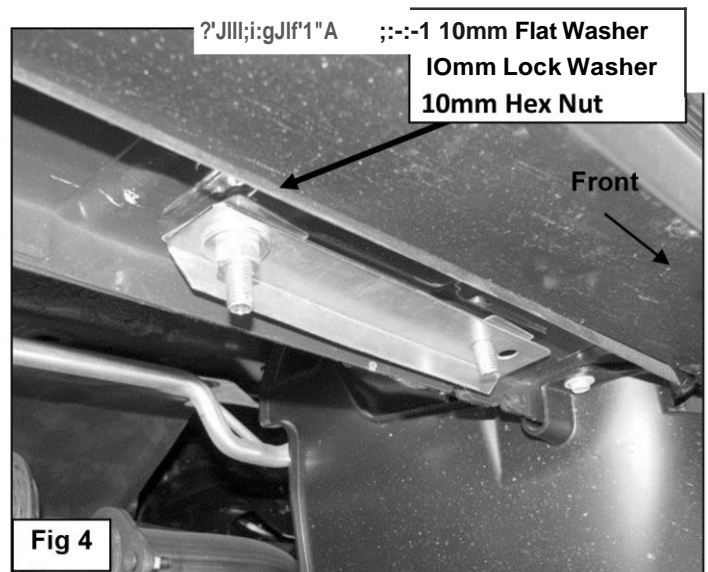
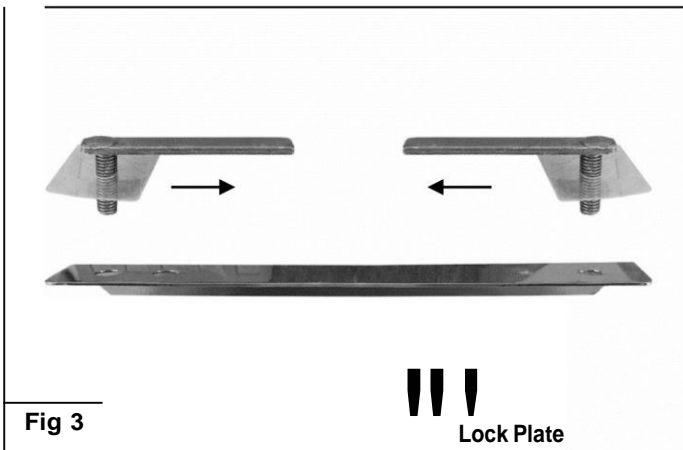


Fig 2B

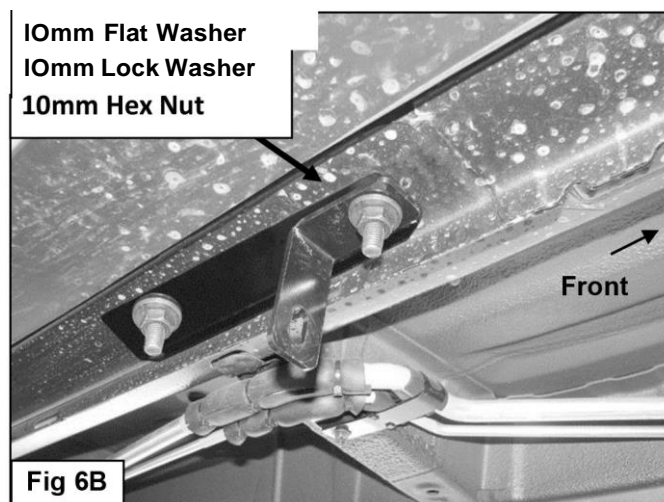
Plastic Retainer

4. Select (1) Lock Plate, (**Figure 3**). Slide the Lock Plate over the (2) Bolt Plates with the bent side toward the pinch weld. Attach the Lock Plate to the rear Bolt Plate only with (1) 10mm Flat Washer, (1) 10mm Lock Washer and (1) 10mm Hex Nut, (**Figure 4**). Tighten the Hex Nut at this time.
5. Locate the round hole in the back of the outer frame channel directly behind the previously installed Bolt Plates, (**Figure 5**). Remove the rubber plug. Select (1) 10mm Bolt Plate and (1) 10mm Plastic Retainer, (**Figure 2A**). Partially thread the Retainer onto the Bolt Plate. Insert the Bolt Plate into the hole and tighten the Retainer as previously described.



IMPORTANT: Mounting areas may be covered with undercoating. Scrape excess undercoating from body panel at all mounting locations. Brackets must mount flat against body panels.

6. Select (1) Front "L" Support Bracket, (**Figure 6A**). Attach the shorter leg on the Support Bracket to the front Bolt Plate with (1) 10mm Flat Washer, (1) 10mm Lock Washer and (1) 10mm Hex Nut, (**Figure 6B**). Leave hardware loose at this time.
7. Select the passenger side Front Mounting Bracket. Attach the Bracket to the Bolt Plate in the back of the frame channel first with (1) 10mm Flat Washer, (1) 10mm Lock Washer and (1) 10mm Hex Nut, (**Figure 7**). Attach the Mounting Bracket to the back of the "L" Support Bracket with (1) 8mm Hex Bolt, (2) 8mm Flat Washers, (1) 8mm Lock Washer and (1) 8mm Hex Nut, (**Figures 7 & 8**). Do not tighten hardware at this time.

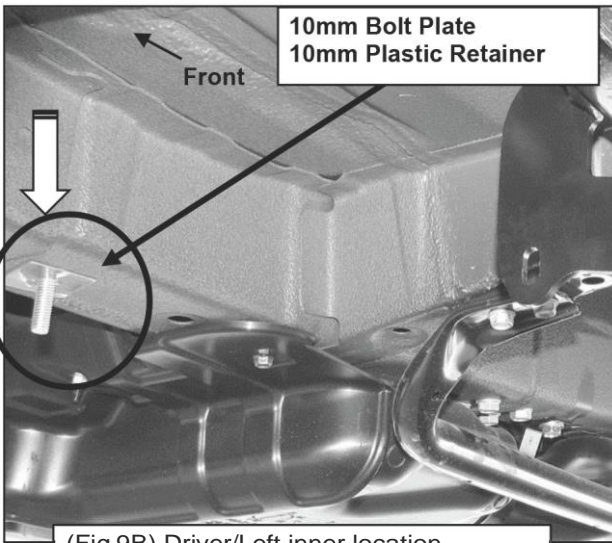
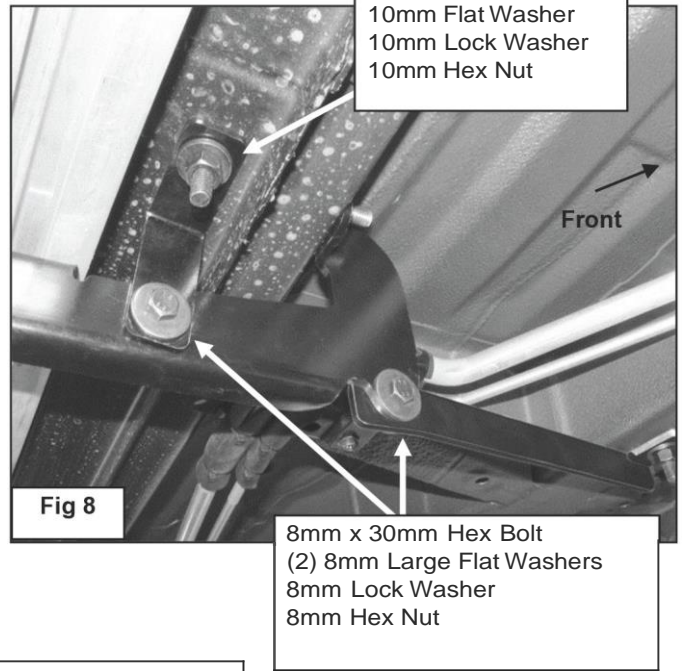
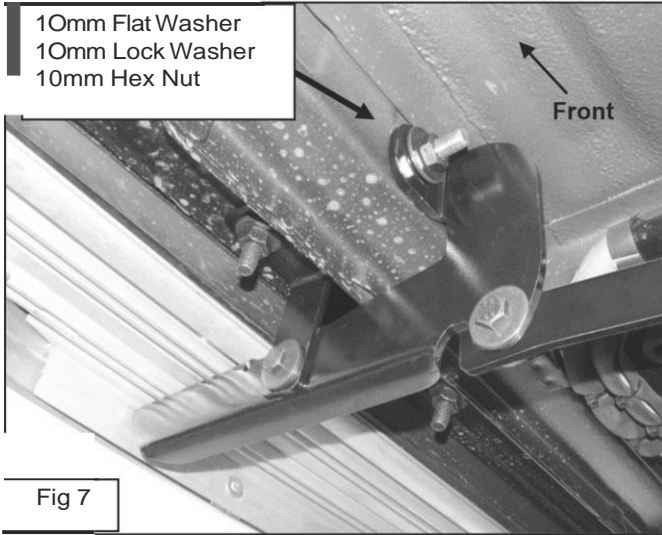


8. Next, locate the factory holes in the bottom of the inner frame channel directly behind the tie down loop where the frame is joined together. Determine the correct factory hole to use:

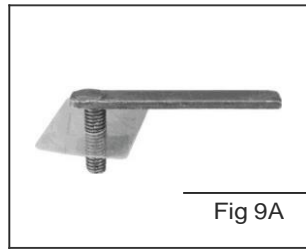
Passenger side installation: Use the 2nd factory hole back from the loop, (Figure 10).

Driver side installation: Use the factory hole closest to the loop, (Figure 9B).

9. Select (1) 10mm Bolt Plate and (1) 10mm Plastic Retainer, (Figure 9A). Partially thread the Retainer onto the Bolt Plate. Insert the Bolt Plate into the correct factory hole in the frame channel as identified in Step 9, (Figures 9B & 10). **IMPORTANT:** The driver side and passenger side Front Inner Support Brackets do not install in the same manner.

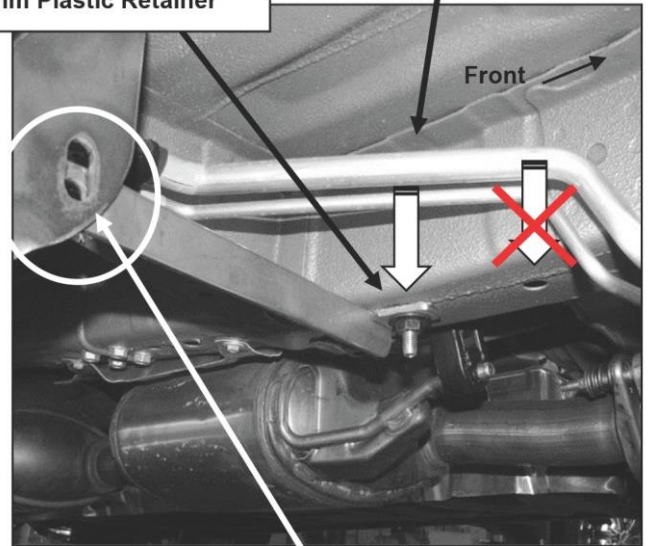


(Fig 9B) Driver/Left inner location pictured. Install Bolt Plate in forward hole closest to tie down loop

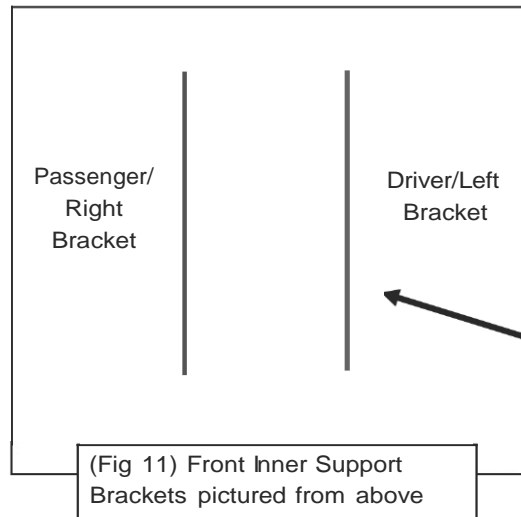


10mm Bolt Plate
10mm Plastic Retainer

Passenger/right inner location pictured. Install Bolt Plate in 2nd hole behind tie down loop



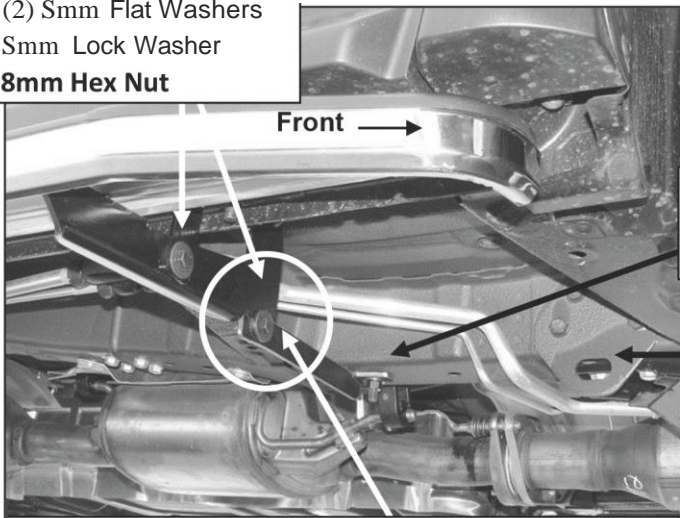
(Fig 10) Passenger/Right inner location pictured. Bolt Support Bracket to back side of Front Bracket



8mm x 30mm Hex Bolt
(2) 8mm Flat Washers
8mm Lock Washer
8mm Hex Nut

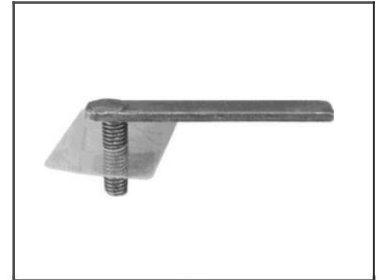
10. Select the correct Inner Front Support Bracket, (Figure 11). Attach the 90-degree bent end of the Support Bracket to the Bolt Plate in the frame channel with (1) 10mm Flat Washer, (1) 10mm Lock Washer and (1) 10mm Hex Nut, (Figure 12). Bolt the outer end of the Support Bracket to the front Mounting Bracket with (1) 8mm Hex Bolt, (2) 8mm Flat Washers, (1) 8mm Lock Washer and (1) 8mm Hex Nut, (Figure 12). Do not tighten hardware at this time. Attach the driver side inner Support Bracket to the front of the Front Mounting Bracket, (Figure 12).

8mm x 30mm Hex Bolt
 (2) 8mm Flat Washers
 8mm Lock Washer
8mm Hex Nut

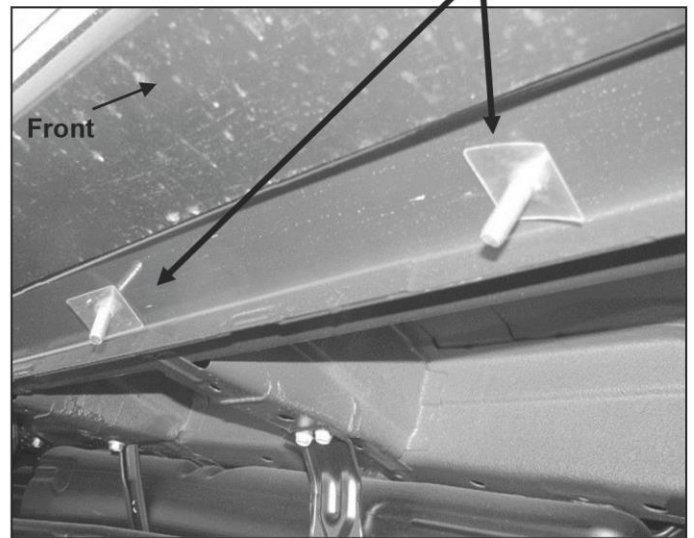


10mm Flat Washer
10mm Lock Washer
10mm Hex Nut

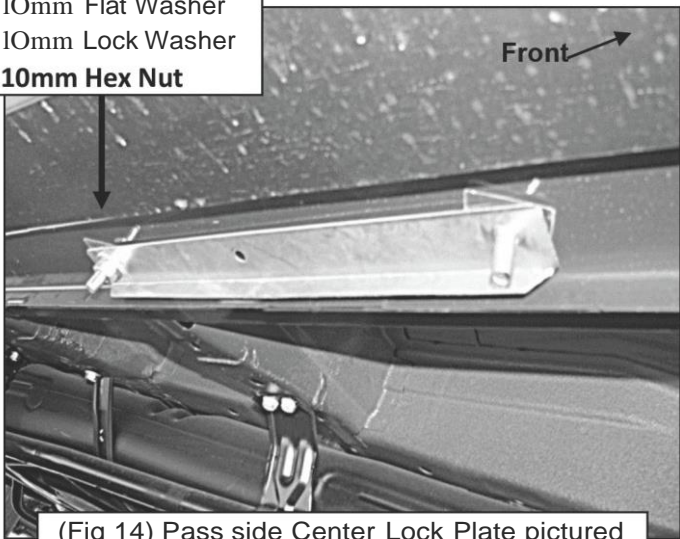
Tie down loop



{Fig 12} passenger side Inner Front Support Bracket pictured.
 NOTE: Bolt passenger side Support Bracket to back of Front Bracket.
 Bolt driver side Support Bracket to front of Front Bracket



10mm Flat Washer
 10mm Lock Washer
10mm Hex Nut



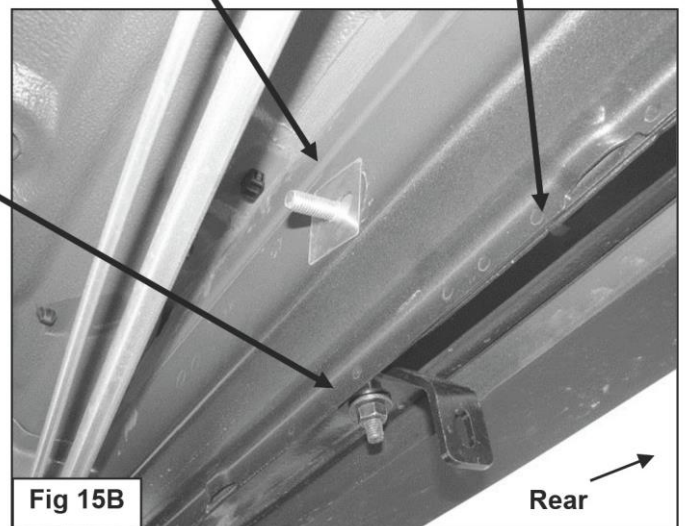
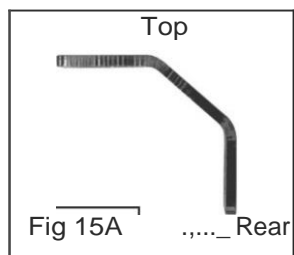
(Fig 14) Pass side Center Lock Plate pictured

Bolt Plate
 (see Fig 13A)

Center Lock Plate

10mm Flat Washer
 10mm Lock Washer
 10mm Hex Nut

Attach longer end of Center Support Bracket to Bolt Plate



Attach the passenger side Inner Support Bracket to the back of the Front Mounting Bracket, (Figure 10).

11. Move along the side of the vehicle to approximately the center/back of the front door. Locate the single hole in the back of the outer frame channel, (Figure 15B). Remove rubber plug if equipped. Next locate and remove the (2) rubber plugs from the bottom of the outer frame channel. Repeat Steps 2-5 to install the (2) Bolt Plates and (1) Long Center Lock Plate to the bottom of the frame channel, (Figures 138 & 14).
12. Select (1) 10mm Bolt Plate and (1) 10mm Plastic Retainer, (Figure 13A). Partially thread the Retainer onto the Bolt Plate. Insert the Bolt Plate into the hole in the back of the frame channel, (Figure 158).
13. Select (1) Center Support Bracket, (Figure 15A). Attach the long end of the Support Bracket to the forward Bolt Plate in the frame channel with (1) 10mm Flat Washer, (1) 10mm Lock Washer and (1) 10mm Hex Nut, (Figures 158 & 17). Select the passenger side Center Bracket, (Figure 16). Attach the Bracket to the Bolt Plate in the back of the frame channel with (1) 10mm Flat Washer, (1) 10mm Lock Washer and (1) 10mm Hex Nut. Bolt the remaining end of the Support Bracket to the front of the Center Bracket with (1) 8mm Hex Bolt, (2) 8mm Flat Washers, (1) 8mm Lock Washer and (1) 8mm Hex Nut, (Figure 17). Do not tighten hardware at this time.

10mm Flat Washer
10mm Lock Washer
10mm Hex Nut

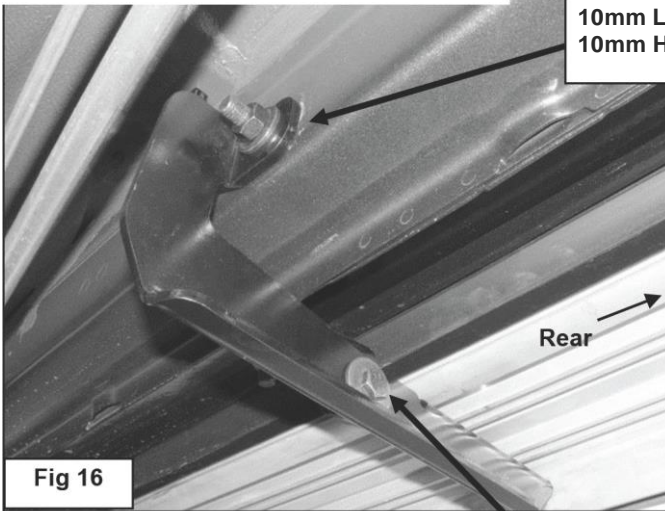


Fig 16

10mm Flat Washer
10mm Lock Washer
10mm Hex Nut

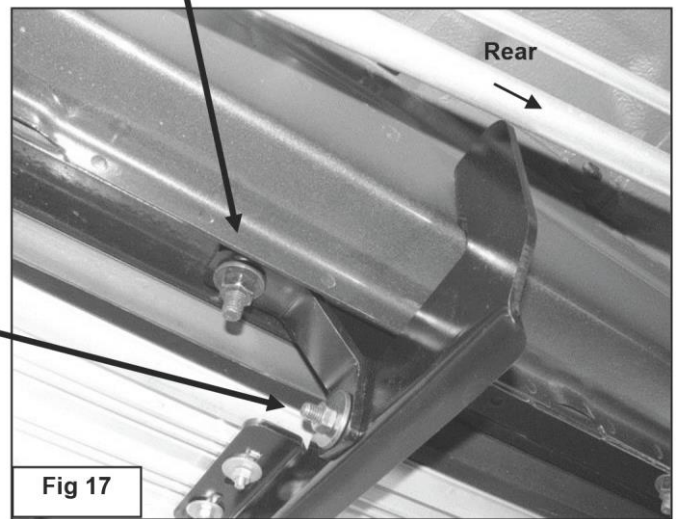
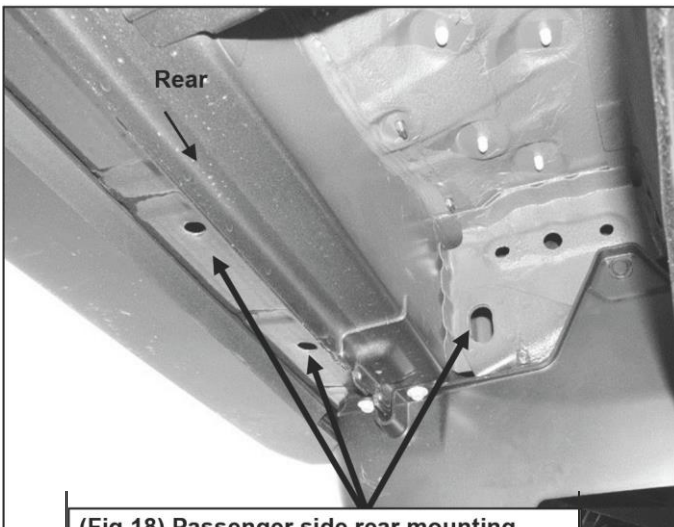


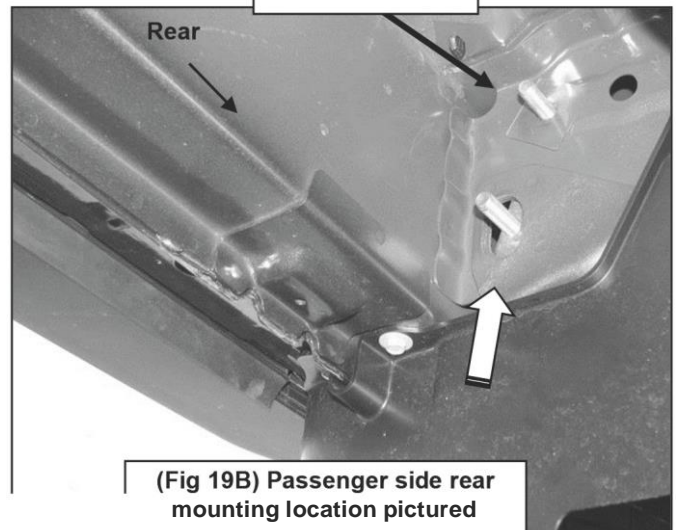
Fig 17

8mm x 30mm Hex Bolt
(2) 8mm Flat Washers
8mm Lock Washer
8mm Hex Nut



(Fig 18) Passenger side rear mounting location pictured from below. Remove rubber plugs from factory holes

Plastic Retainer

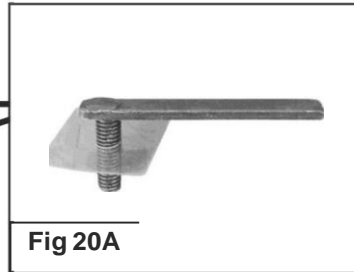
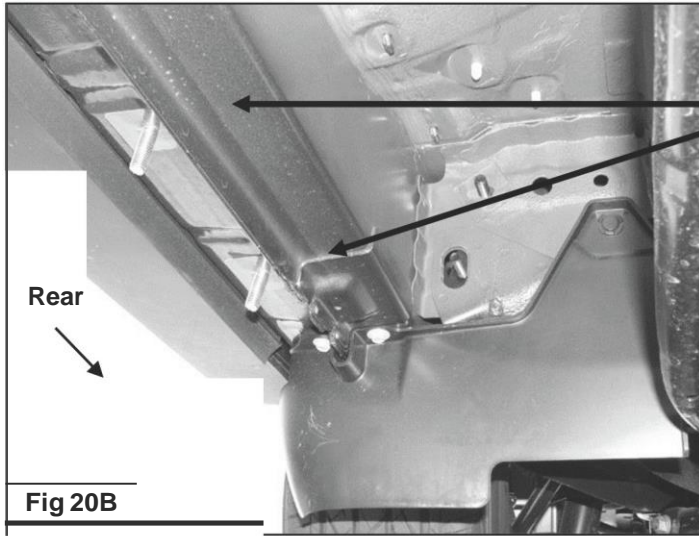


(Fig 19B) Passenger side rear mounting location pictured

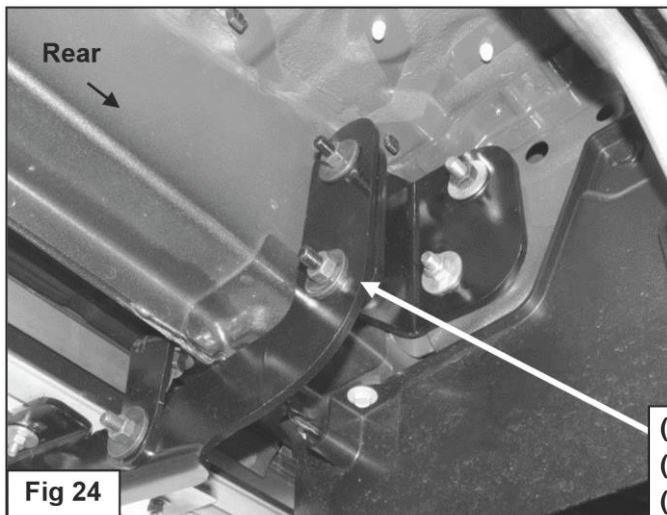
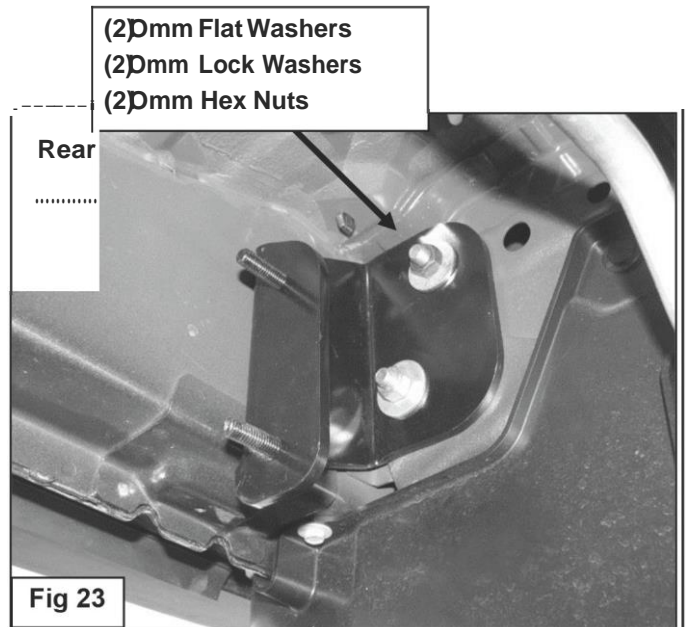
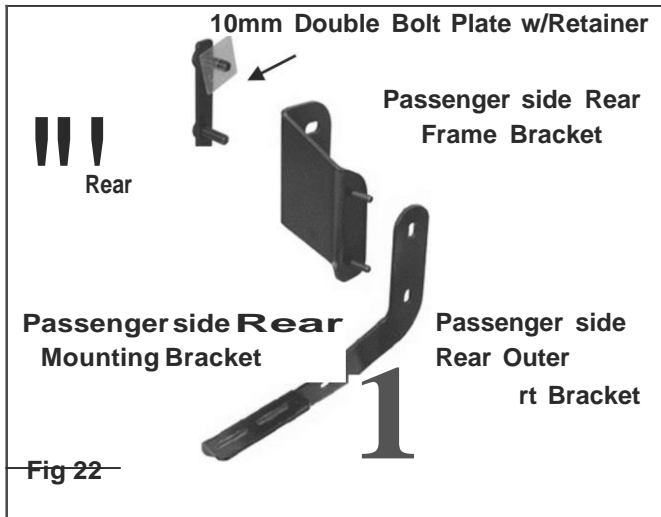
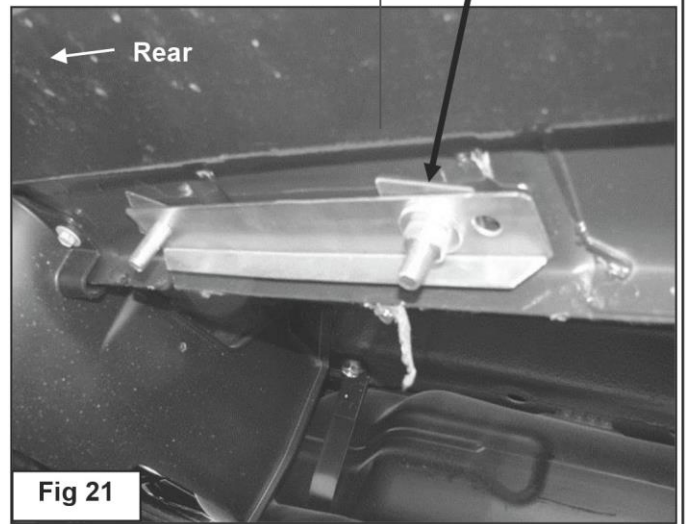


Fig 19A

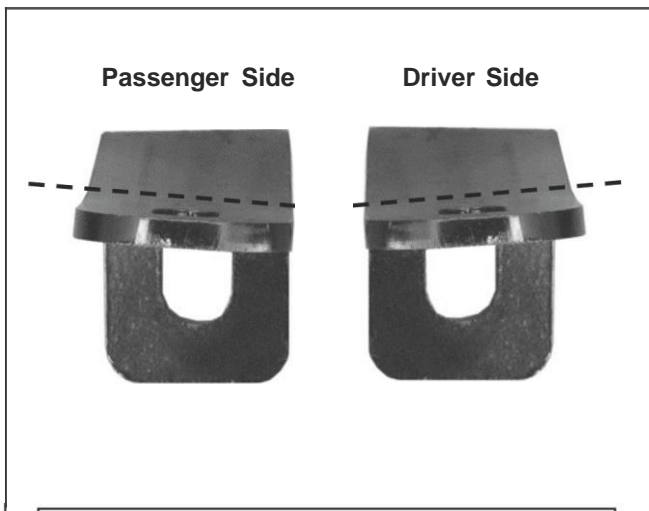
14. Move to the rear mounting location in front of the passenger side rear tire opening. Locate the large oval and the round holes in the inner body panel in front of the rear tire, **(Figure 18)**. Select (1) 10mm Double Bolt Plate and (1) 10mm Plastic Retainer, **(Figure 19A)**. Insert the Bolt Plate into the oval hole and up and out of the smaller round hole above it. Thread the Plastic Retainer onto the Bolt Plate in the round hole only, **(Figure 198)**.
15. Locate the last (2) round holes along the floor panel, **(Figure 18)**. Repeat **Steps 2-5** to install the (2) Bolt Plates and Lock Plate, **(Figures 20A & 208)**. **NOTE:** Attach the Lock Plate to the front Bolt Plate only with (1) 10mm Flat Washer, (1) 10mm Lock Washer and (1) 10mm Hex Nut, **(Figure 21)**. Tighten the Hex Nut at this time.
16. Select the passenger side rear Frame Bracket, **(Figure 22)**. Attach the Frame Bracket to the Double Bolt Plate with (2) 10mm Flat Washers, (2) 10mm Lock Washers and (2) 10mm Hex Nuts, **(Figure 23)**. Do not tighten hardware at this time. Next, attach the driver side Rear Mounting Bracket to the front of the Frame Bracket with (2) 8mm Flat Washers, (2) 8mm Lock Washers and (2) 8mm Hex Nuts, **(Figure 24)**. Do not tighten hardware at this time.



10mm Flat Washer
10mm Lock Washer
10mm Hex Nut



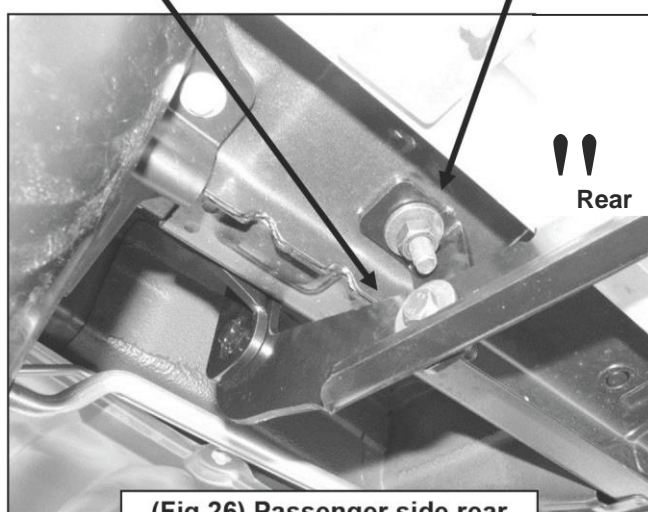
17. Select the passenger side "7" Rear Support Bracket, (**Figure 25**). Attach the Support Bracket to the rear Bolt Plate with (1) 10mm Flat Washer, (1) 10mm Lock Washer and (1) 10mm Hex Nut, (**Figures 22 & 26**). Do not tighten hardware. Line up the remaining hole in the Rear Bracket with the "7" Rear Support Bracket. Bolt the Mounting Bracket to the back of the "7" Rear Support Bracket with (1) 8mm Hex Bolt, (2) 8mm Flat Washers, (1) 8mm Lock Washer and (1) 8mm Hex Nut, (**Figure 26**). Do not tighten hardware at this time.
18. Carefully unwrap the Running Boards and select the passenger side Running Board. Insert (6) 6mm T-Bolts into the slots in the ends of the channels, (3 T-Bolts per slot), on the bottom of the Running Board, (**Figure 27**). Hold the Running Board up in the approximate position and slide the T-Bolts down the slots to line up with the Brackets. Tilt the Running Board up at a slight angle to clear the slots in the Brackets. Secure the Running Board to the Brackets with (6) 6mm Flat Washers, (6) 6mm Lock Washers and (6) 6mm Hex Nuts, (**Figure 28**). **NOTE:** The Running Board is designed to fit close to the vehicle. It may be necessary to loosen the Mounting Brackets and tilt the Brackets downward to insert the Running Board. Do not fully tighten hardware at this time.
19. Level and adjust the Running Board and tighten all hardware.
20. Repeat **Steps 2-20** for driver side Running Board installation.
21. Do periodic inspections to the installation to make sure that all hardware is secure and tight.



(Fig 25) Pictured from below to show bends

8mm x 30mm Hex Bolt
 (2) 8mm Flat Washers
 8mm Lock Washer
 8mm Hex Nut

6mm Flat Washer
 6mm Lock Washer
 6mm Hex Nut



(Fig 26) Passenger side rear Bracket pictured from below

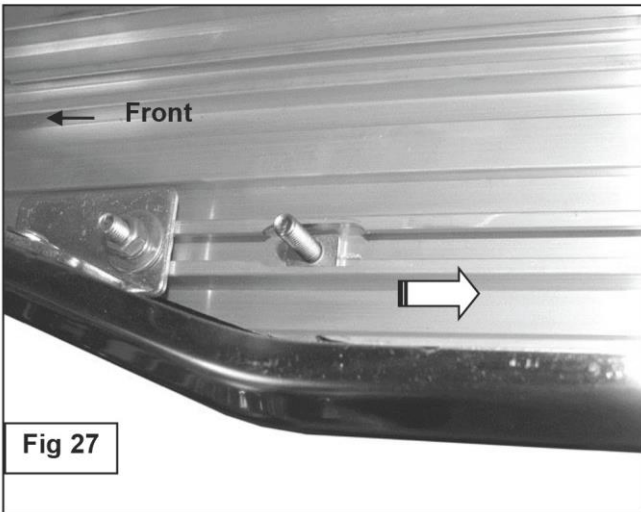


Fig 27

6mm Flat Washers
 6mm Lock Washers
 6mm Hex Nuts

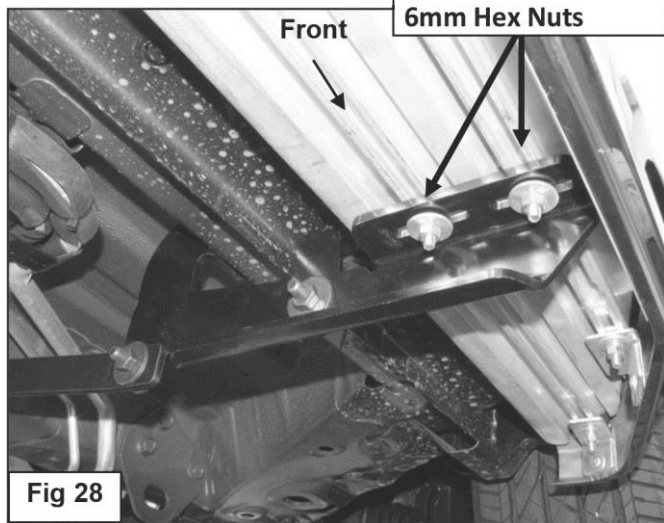
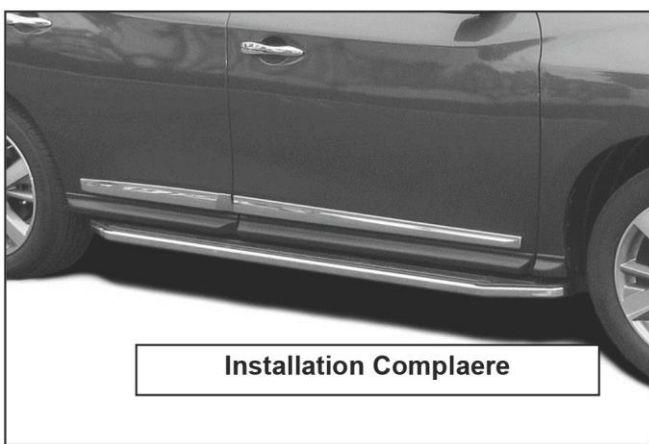


Fig 28



Installation Complete

PRODUCT CARE

- Periodically check the product to ensure all fasteners are tight and components are intact.
- Regular waxing is recommended to protect the finish of the product.
- **Use ONLY Non-Abrasive automotive wax.** Use of any soap, polish or wax that contains an abrasive is detrimental and can scratch the finish leading to corrosion.
- Aluminum polish may be used to polish small scratches and scuffs for **Stainless Steel finish.**
- Mild soap may be used to clean the product for both **Stainless Steel and Black finish.**

1. Hardware's are not of correct size.

In GMC / Chevrolet truck model 2006 & up, customer needs to reuse the factory body bolts to install the bracket. If your vehicle is not GMC / Chevrolet 2006 & up, ensure that holes are not partially covered with any plastic grommet or rust? If it is, remove the plastic grommet & rust from the thread holes & re-try the installation.

2. Mounting Bracket are not getting Installed properly.

In some cases Illustration images shown in Installation manual may not be the exactly same as per actual vehicle images ,also if Driver / Passenger side mounting brackets are very identical in the design, suggest referring Parts Identification guide to avoid fitment issue.

3. Products are thumping / rattling after installation.

Ensure that all required mounting brackets / hardware's are installed & tighten correctly. Suggest using white lithium / regular grease between the metal to metal contact surfaces.

4. Side Bar is not aligning with vehicle / Step Pads are not aligning with vehicle doors.

Side bar may be interchanged or mounting brackets are not installed at the correct position in the vehicle. Refer Parts identification guide.

6. Missing / Excess Hardware.

Recheck hardware count as per the part list.

6. Product not installing properly.

Ensure make model year, cab length and bed size of your vehicle is listed in the application. All installation steps are followed correctly.