

BLACK MODULAR GLADIATOR ROLL BAR FOR 1/2 TON TRUCKS (GM-FORD-DODGE TUNDRA) FLAT BASE  
WITH LED BRAKE LIGHT



## **INSTALLATION INSTRUCTIONS**

**BLACK MODULAR GLADIATOR ROLL BAR FOR 1/2 TON TRUCKS  
(GM-FORD-DODGE TUNDRA) FLAT BASE WITH LED BRAKE LIGHT**

**PART # GLRB-01B**



## Before Installation

- Please read the instruction completely for easy installation, which will also help you to avoid scratches or other potential damages to your appealing car.
- The information shown here is for reference only and may differ from the product that you receive, however the goods are fitted in the same way.





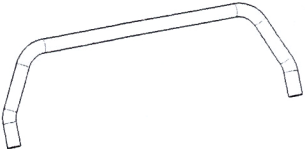
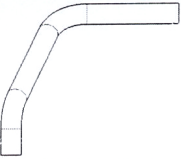
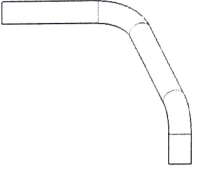

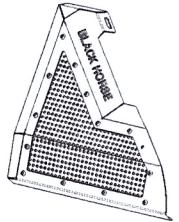
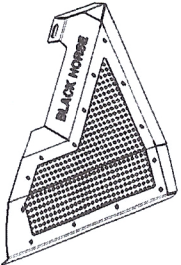
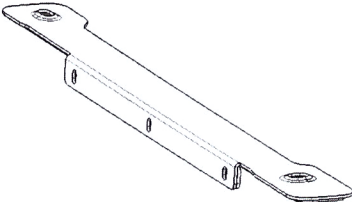
## Care and Cleaning

- Mild soap may be used also to clean the Product.
- Please periodically check and retighten all the hardware and clean the investment for a refresh look.

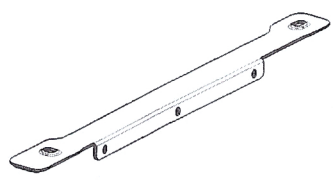
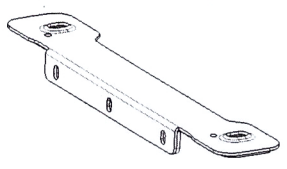

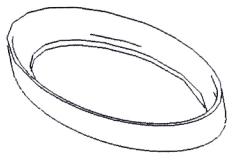
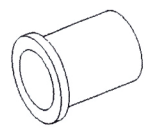
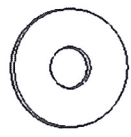
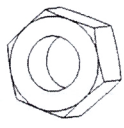
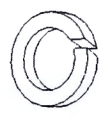
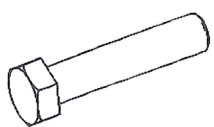
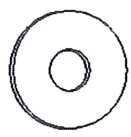
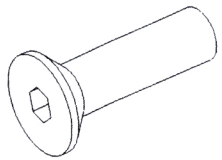

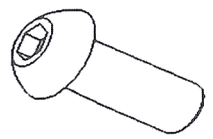

## Parts list

NO.	QTY	PICTURE	NO.	QTY	PICTURE
①	1	 MAIN TUBE	②	1	 SIDE TUBE (D)
③	1	 SIDE TUBE (P)	④	1	 SIDE TUBE (MIDDLE)
⑤	2	 SIDE RAIL	⑥	1	 SIDE PLATE(D)
⑦	1	 SIDE PLATE(P)	⑧	1	 REAR MOUNTING BASE (D)

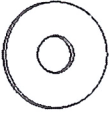
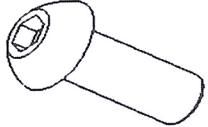
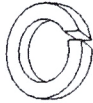
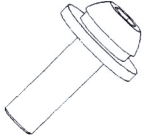
BLACK MODULAR GLADIATOR ROLL BAR FOR 1/2 TON TRUCKS (GM-FORD-DODGE TUNDRA) FLAT BASE  
WITH LED BRAKE LIGHT

<p>⑨</p> <p>1</p>		<p>REAR MOUNTING BASE (P)</p>	<p>⑩</p> <p>2</p>	 <p>FRONT MOUNTING BASE (D&amp;P)</p>
<p>⑪</p> <p>6</p>		<p>RUBBER COVER 1</p>	<p>⑫</p> <p>2</p>	 <p>RUBBER COVER 2</p>
<p>⑬</p> <p>4</p>		<p>FLAT HEAD RIVETED NUT M10-18</p>	<p>⑭</p> <p>22</p>	 <p>FLAT WASHER D10</p>
<p>⑮</p> <p>10</p>		<p>HEX NUT M10</p>	<p>⑯</p> <p>12</p>	 <p>SPRING WASHER D10</p>
<p>⑰</p> <p>12</p>		<p>HEXAGON BOLT M110-35</p>	<p>⑱</p> <p>2</p>	 <p>FLAT WASHER D8</p>
<p>⑲</p> <p>8</p>		<p>HEX SOCKET COUNTERSUNK HEAD SCREW M10_35</p>	<p>⑳</p> <p>2</p>	 <p>SPRING WASHER D8</p>
<p>㉑</p> <p>2</p>		<p>SOCKET HEAD CAP SCREW M8_20</p>	<p>㉒</p> <p>4</p>	 <p>HEX NUT M6</p>

BLACK MODULAR GLADIATOR ROLL BAR FOR 1/2 TON TRUCKS (GM-FORD-DODGE TUNDRA) FLAT BASE  
WITH LED BRAKE LIGHT

<p>23</p>	<p>4</p>	 <p>FLAT WASHER D6</p>	<p>24</p>	<p>2</p>	 <p>SOCKET HEAD CAP SCREW M6_20</p>
<p>25</p>	<p>2</p>	 <p>SPRING WASHER D6</p>	<p>26</p>	<p>10</p>	 <p>BUTTON HEAD BOLT ASSEMBLY M6_20</p>
<p>27</p>	<p>1</p>	 <p>ALLEN WERNCH S=4</p>	<p>28</p>	<p>1</p>	 <p>RED PLASTIC PLATE</p>
<p>29</p>	<p>1</p>	 <p>ALLEN WERNCH S=6</p>	<p>30</p>	<p>1</p>	 <p>ALLEN WERNCH S=5</p>
<p>31</p>	<p>1</p>	 <p>ALLEN WERNCH S=2.5</p>			

## Installation Fig.

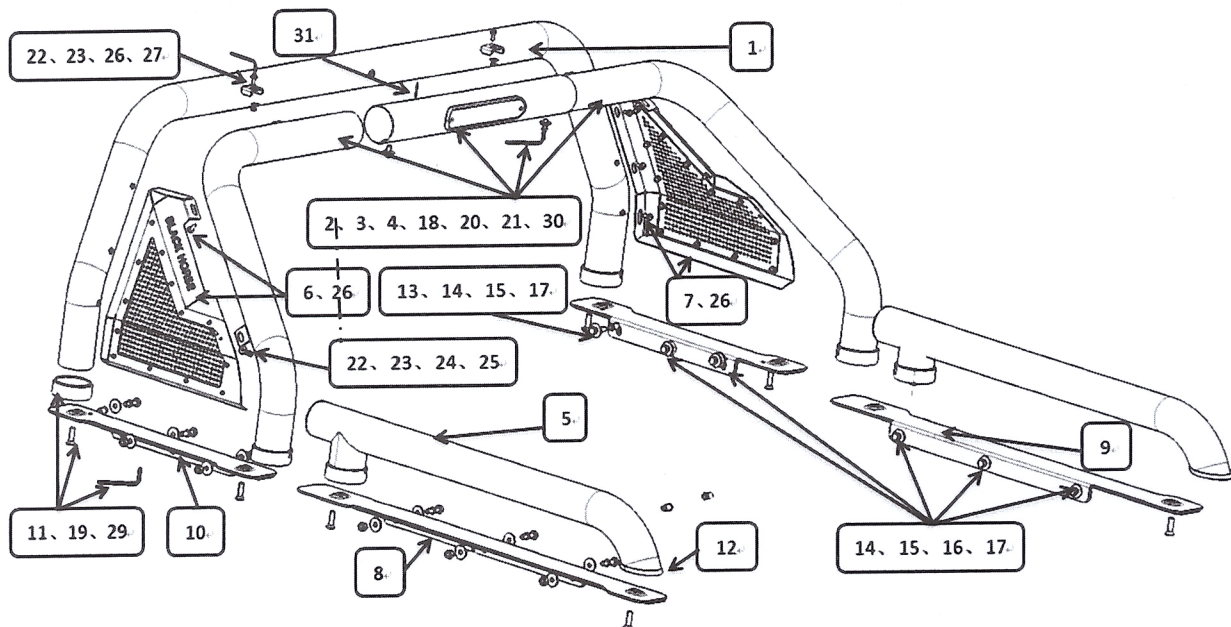

Step 1: Verify that all parts are present according to the manual.

Step 2: Connect side tube (D&P) and central side tube with accessories ② ③ ④ ⑱ ⑳ ㉑ ⑳ ㉒, adjust to the suitable position, and then lock tighten.

Step 3: Connect the main tube and side tube with accessories ⑳ ㉓ ㉔ ㉕, notice: don't lock tighten.

Step 4: Install the side decorated plate with accessories ⑥ ㉖ ㉗ ㉘ ㉙, notice: don't lock tighten.

Step 5: Install side rail on rear mounting base with accessories ⑭ ⑮ ⑯ ⑰, lock tighten.

Step 6: Adjust all the parts to suitable position, install front mounting base (D&P) with accessories ① ⑱ ㉚, then fully tighten all accessories.

Step 7: Place the roll bar on truck bed and adjust suitable position, then find appropriate installing hole for front & rear mounting baser and drilled a hole and install with accessories ⑭ ⑮ ⑯ ⑰,

(If someplace can't install with nut, you could use ⑬ to install.)

Step 8: To firmly fix the roll bar, install the red plastic plate on the decoration part.

Step 9: Complete installation, pick up all tools.

BLACK MODULAR GLADIATOR ROLL BAR FOR 1/2 TON TRUCKS (GM-FORD-DODGE TUNDRA) FLAT BASE  
WITH LED BRAKE LIGHT

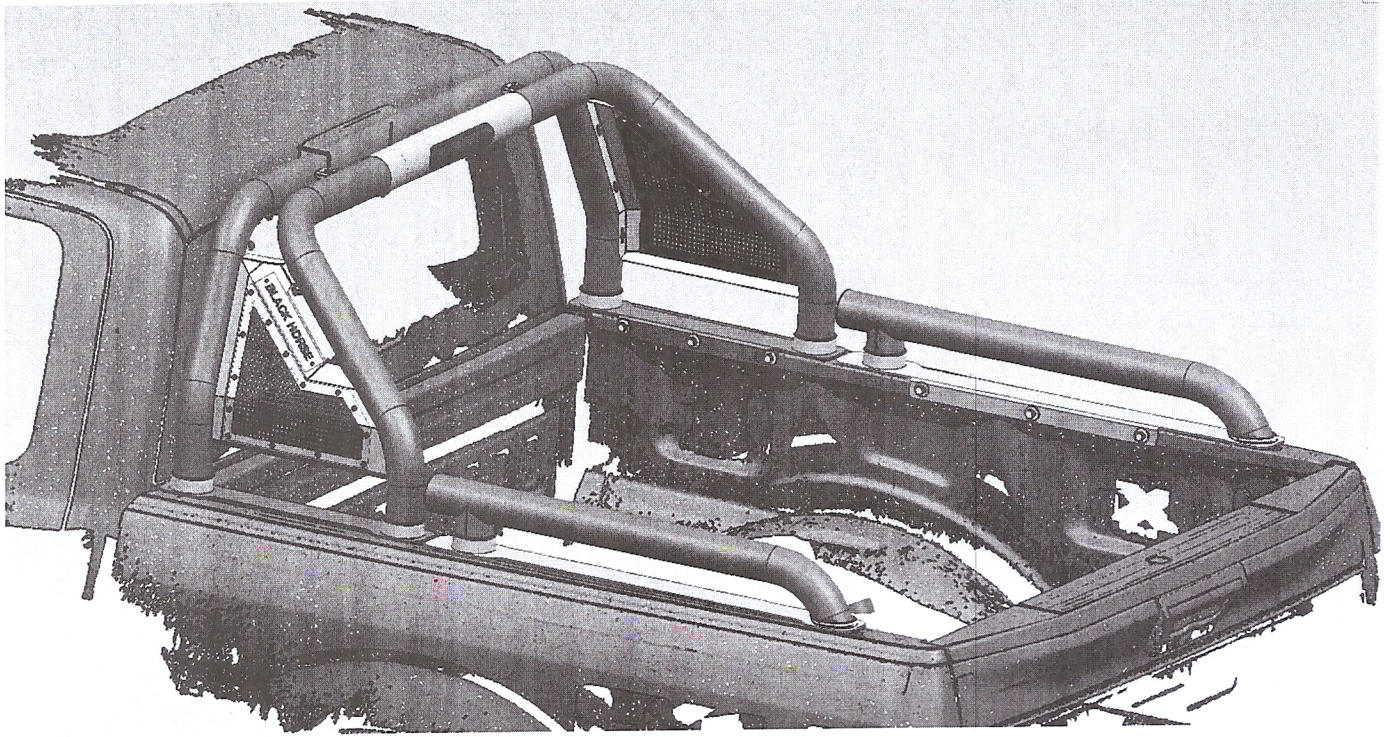

**NOTE**

Any damages and losses caused by improper installation and application, goes beyond our quality warranty.