

BRACKETS FOR UNIVERSAL REAR BUMPER GUARD (DOUBLE LAYER) FOR HONDA HR-V  
2017(USE RB01S)



# **INSTALLATION INSTRUCTIONS**

**BRACKETS FOR UNIVERSAL REAR BUMPER GUARD (DOUBLE  
LAYER) FOR HONDA HR-V 2017(USE RB01S)**

**PART #H5**

BRACKETS FOR UNIVERSAL REAR BUMPER GUARD (DOUBLE LAYER) FOR HONDA HR-V  
2017(USE RB01S)







### Before Installation

- Please read the instruction completely for easy installation, which will also help you to avoid scratches or other potential damages to your appealing car.
- The information shown here is for reference only and may differ from the product that you receive, however the goods are fitted in the same way.



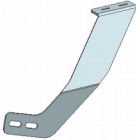
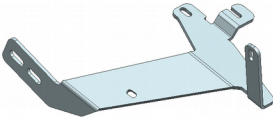
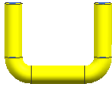



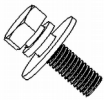

### Care and Cleaning

- Mild soap may be used also to clean the Product.
- Please periodically check and retighten all the hardware and clean the investment for a refresh look.

### Parts list

NO.	QTY	PICTURE	NO.	QTY	PICTURE
	1	 Rear bar		1	 Bracket-A(R)
	1	 Bracket-A(L)		1	 Bracket-B-L
	1	 Bracket-B-R(1)		1	 U-Bolt M8
	3	 Flat washer D6		1	 Spring washer D6
	1	 Hex bolt M6*25		2	 Hex nut D6

BRACKETS FOR UNIVERSAL REAR BUMPER GUARD (DOUBLE LAYER) FOR HONDA HR-V  
2017(USE RB01S)

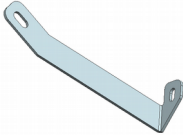
5	 Hex bolt M8*25	3	 Flat washer D8
2	 Spring washer D8	3	 Hex nut M8
8	 Flat washer D10	4	 Hex bolt M10*35
4	 Hex nut M10	4	 Spring washer D10
1	 Bracket-B-R(2)		

Installation pictures

FIG.1

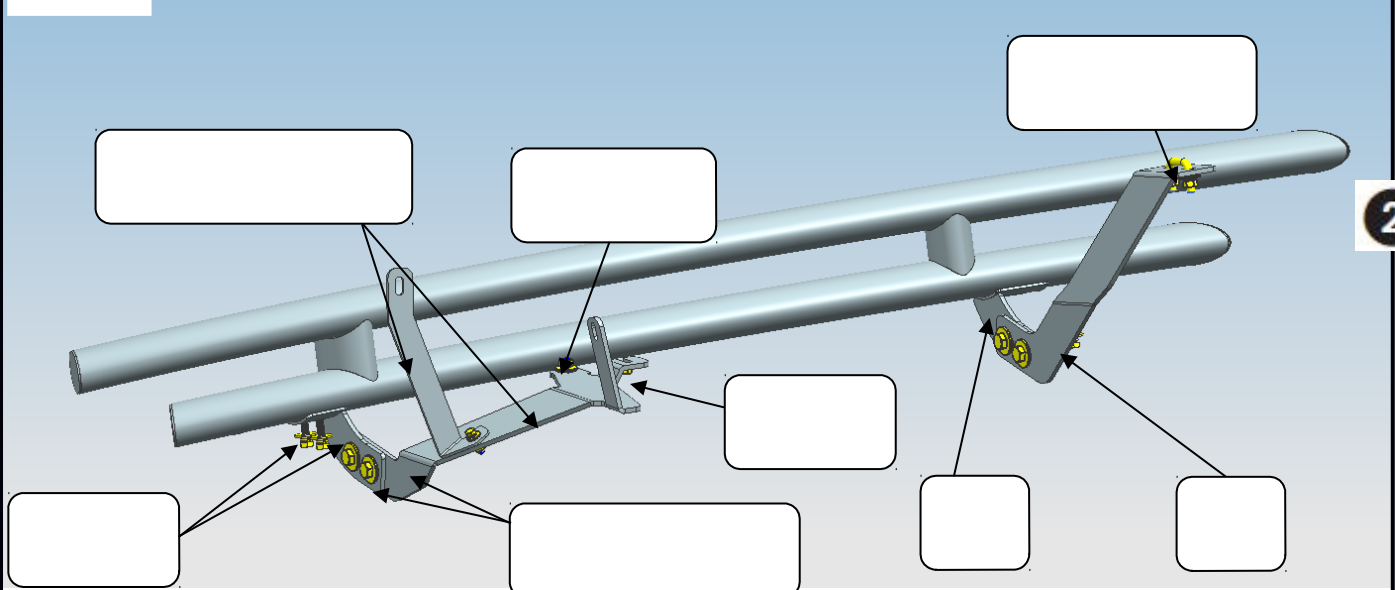

BRACKETS FOR UNIVERSAL REAR BUMPER GUARD (DOUBLE LAYER) FOR HONDA HR-V  
2017(USE RB01S)

**FIG.2 LEFT BRACKET INSTALLATION**

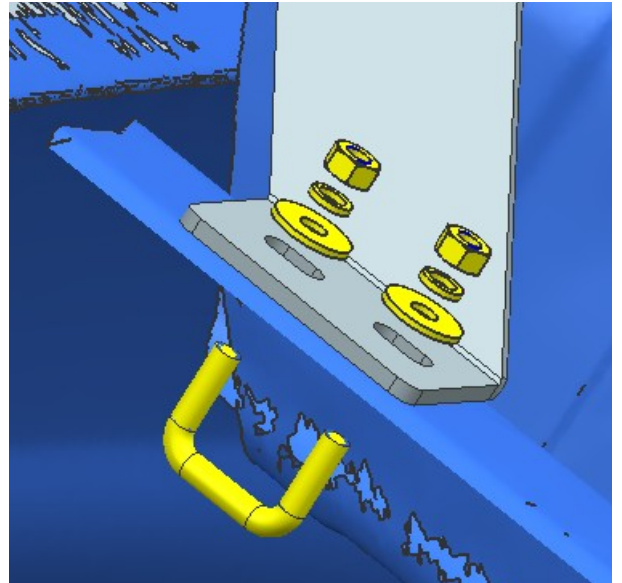
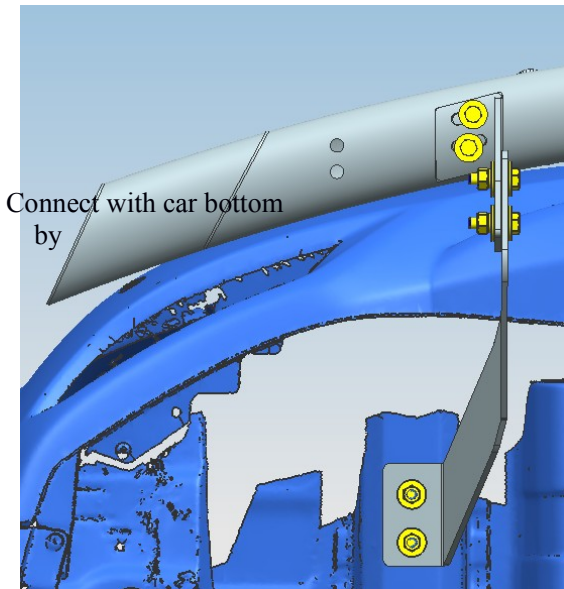

**FIG.3 RIGHT BRACKET INSTALLATION**

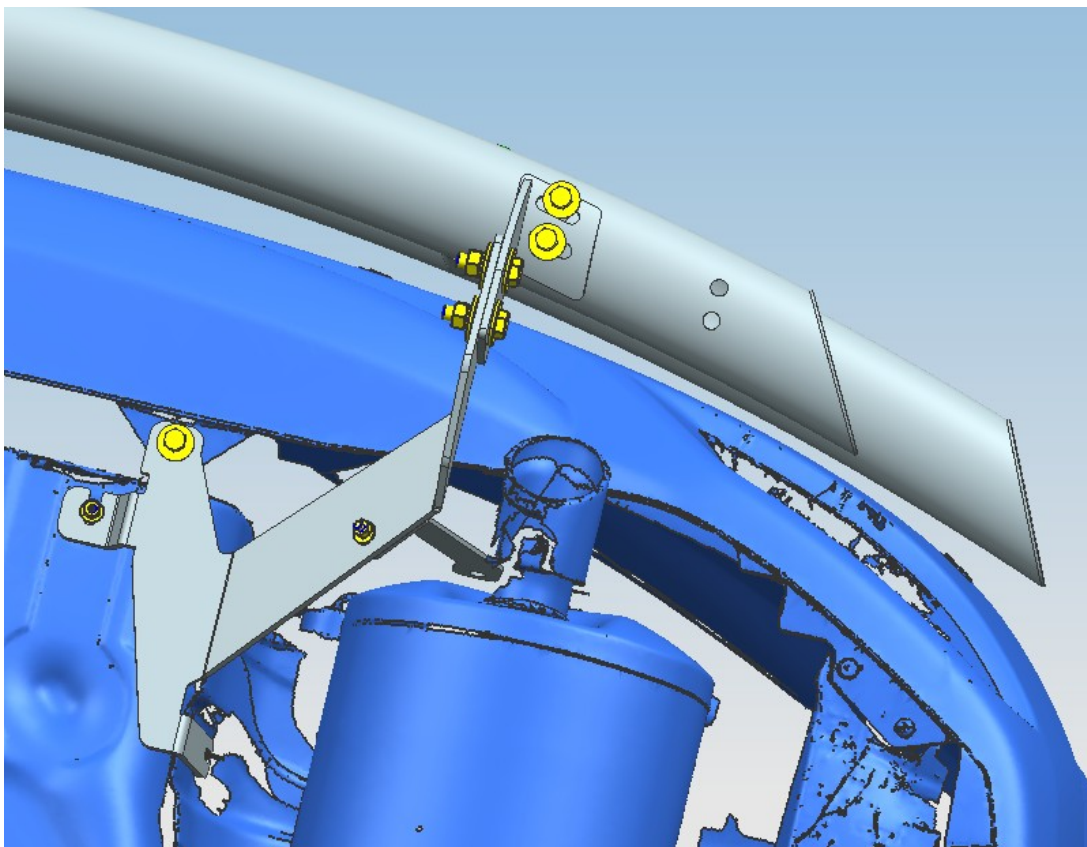

## ● INSTALLATION PROCEDURES:

**Step 1:** Check all the contents are available in accordance with the above list.

**Step 2:** Remove the bottom factory skid plate, using U-bolt to install Bracket-B(L) with factory hole as **FIG.2**. Do not tighten the bolts.

**Step 3:** As **FIG.3** shown, using factory bolts to install Bracket-B(R). Do not tighten the bolts.

**Step 5:** Connect the Bracket-A(L&R) with Bracket-B(L&R). Do not tighten the bolts.

**Step 6:** Place rear bar on Bracket-A(L&R) and install by .

**Step 7:** Test the position properly, then tighten all the parts to make sure that the rear bar is steadily fixed

**Step 8:** If you need to reinstall the factory skid plate, need to cut suitable position to compatible with our bracket and install by factory bolts.

Installation complete

## NOTE

Any damages and losses caused by improper installation and application, goes beyond our quality warranty.