







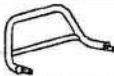

INSTALLATION INSTRUCTION
ITEM NO: BBMIOUSS

ATTENTION

1. Please read this installation instruction before installing this part.
When install it, please pay attention to protecting your vehicles.
2. When you use it, please check this parts at a fix time-lapse, such as one month or two month.

PARTS LIST

No	Name	Photo	Qty	Remarks	No	Name	Photo	Qty	Remarks
1	Grille Guard		1		4	Lock Washer		4	M12
2	Mount Bracket		2	Lateral symmetry	5	Hex Nut		4	M12
3	Bolt		4	M12X30	6	flat washer		8	M12

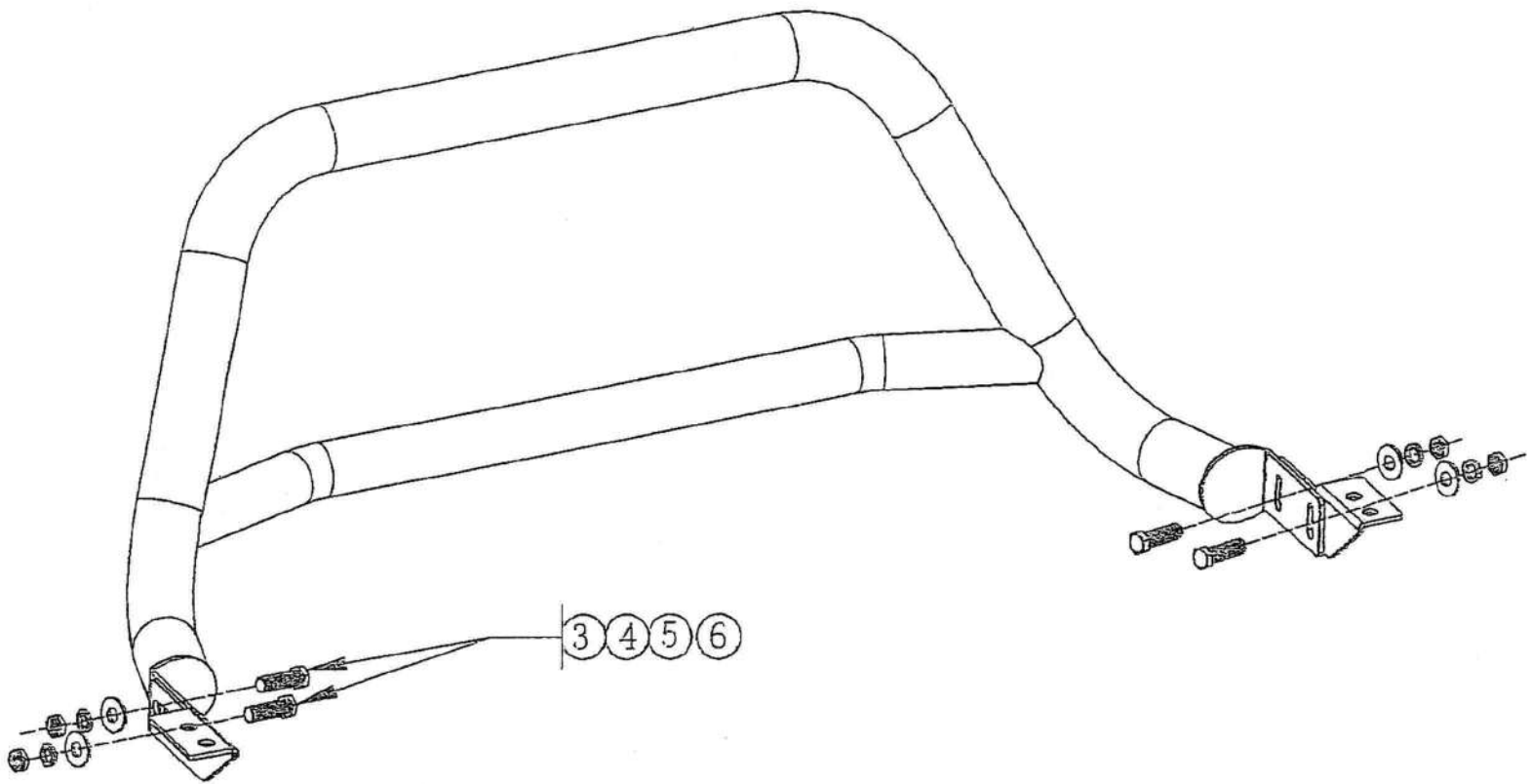

- STEP 1: Check the parts in the box carefully if match above list.
- STEP 2: Pls prepare the tools for installation, follow as: 17-19wrench.
- STEP 3: Install the mount bracket on the girder of the car, and tighten it with Car Bolt with bread.
- STEP 4: Install the Grille Guard on the mount bracket, and tighten it with M12X30bolt.
- STEP 5: Installation is finished.