



Rear Step Bar

Part No. 8DOPRA



Fits: 2014- Current Dodge Ram ProMaster



REMOVE CONTENTS FROM BOX. VERIFY ALL PARTS ARE PRESENT.



60-180 min

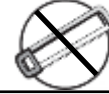

CUTTING NOT
REQUIRED



DRILLING NOT
REQUIRED



READ INSTRUCTIONS CAREFULLY BEFORE STARTING INSTALLATION.

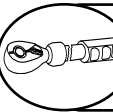

DO NOT OVER TORQUE. STANDARD OPERATING LOAD FOR TIGHTEN
BODY MOUNT NUTS & BOLTS VARIES FROM 45 TO 65 FOOT POUND.

PARTS LIST:

Qty	Part Description	Qty	Part Description
1	Rear Step	2	12mm Lock Washers
1	Driver/left Frame Mounting Bracket	2	12mm Hex Nuts
1	Passenger/right Frame Mounting Bracket	2	6mm Double Bolt Plates
2	12mm Bolt Plates	4	6mm x 22mm x 2mm Flat Washers
2	12mm Plastic Retainers	4	6mm Lock Washers
2	12mm x 32mm x 3mm Flat Washers	4	6mm Hex Nuts

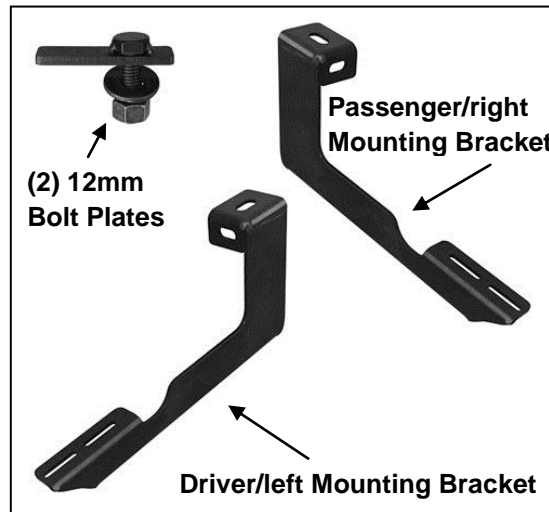

PROCEDURE:

INSTALLATION MAY INTERFERE WITH FACTORY OR AFTERMARKET TOW HITCH AND/OR

BACKUP
SENSOR

**WARNING: ALLOW TIME FOR THE MUFFLER TO COOL COMPLETELY BEFORE
INSTALLING REAR BUMPER GUARD BRACKETS.**

OPERATION.

1. Starting on the passenger side of the vehicle, locate the square hole in end of the rear frame channel, **(Figure 1)**. **NOTE:** Remove rubber plug if equipped. Next, remove the factory hex nut attaching the bottom bumper bracket bolt to the frame channel inside the rear tow hook.
2. Insert (1) 12mm Bolt Plate into the square hole in the bottom of the frame channel, **(Figures 1 & 2)**. Use the included 12mm Plastic Retainer to help hold the Bolt Plate in place in the frame.

Remove factory hex nut and rubber plug

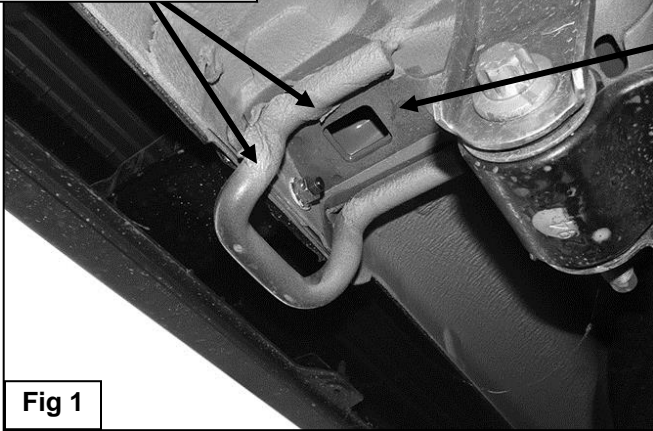

Fig 1

Remove excess sealant as necessary to clear bracket for proper fitment



(Fig 2) 12mm Bolt Plate

3. Select the passenger/right side Frame Mounting Bracket. Attach the Bracket to the Bolt Plate with the included 12mm Flat Washer, 12mm Lock Washer and 12mm Hex Nut, **(Figure 3)**. Reuse the factory hex nut to attach the mounting tab on the Bracket to the bumper bracket bolt. Do not fully tighten hardware at this time.

Reuse factory bumper bolt hardware

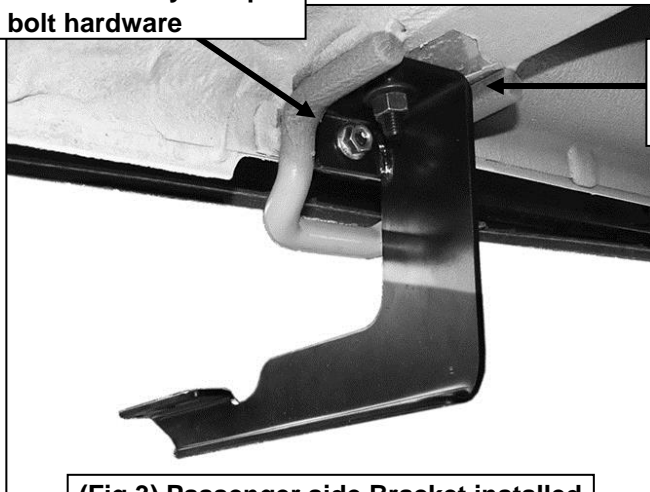

12mm Flat Washer
12mm Lock Washer
12mm Hex Nut

(Fig 3) Passenger side Bracket installed

4. Repeat **Steps 1—3** to install the driver side Bracket.
5. Select the Rear Step. Place the Step on top of the Brackets. Select (2) 6mm Double Bolt Plates, **(Figure 4)**. Insert the Bolt Plates up and into the channels in the bottom of the Step closest to the location of the Brackets, **(Figure 4)**. Raise the Step up and slide the Bolt Plates down through the slots in the Brackets.

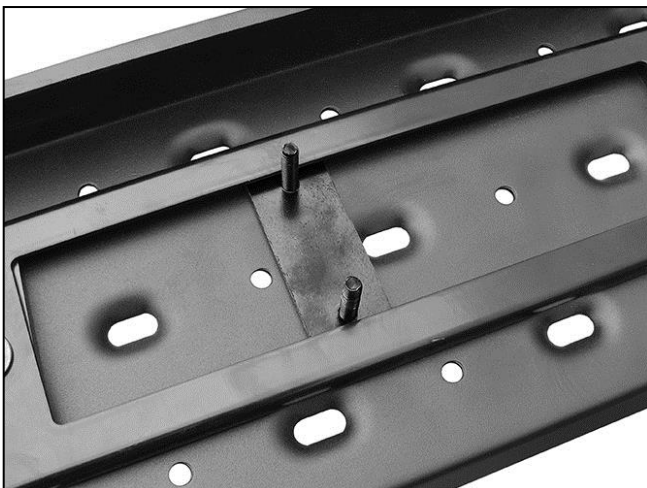

(Fig 4) Slide Double Bolt Plates into track on bottom of Step

6. Attach the Step to the Brackets with (4) 6mm Flat Washers, (4) 6mm Lock Washers and (4) 6mm Hex Nuts, (**Figure 5**). Do not fully tighten hardware at this time.

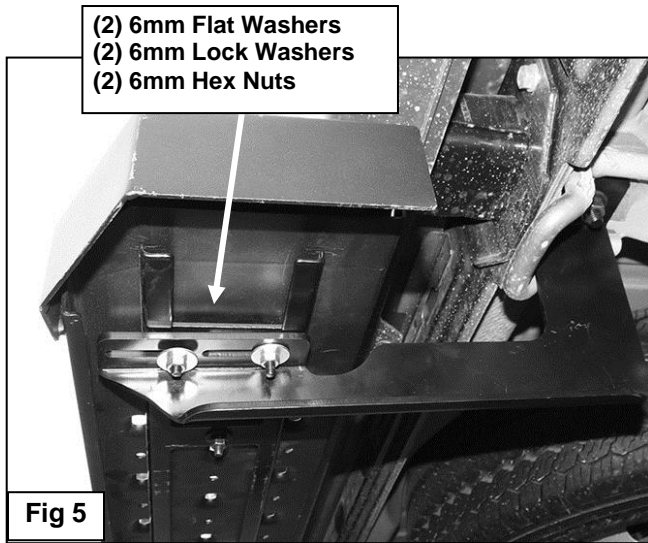

7. Align and adjust the Rear Step as necessary and fully tighten all hardware.
8. Do periodic inspections of the installation to make sure that all hardware is secure and tight.

