









INSTALLATION INSTRUCTION  
ITEM NO: 8D140518SS

ATTENTION

1. Please read this installation instruction before installing this part.  
When install it, please pay attention to protecting your vehicles.
2. When you use it, please check this parts at a fix time-lapse, such as one month or two month.

PARTS LIST

No	Name	Photo	Qty	Remarks	No	Name	Photo	Qty	Remarks
1	Rear guard		1		5	Hex Nut		8	M12
2	Mount Bracket		2	Lateral symmetry	6	flat washer		12	M12
3	"U" Bolt		2	M12	7	Lock Washer		8	M12
4	Bolt		4	M12X35					

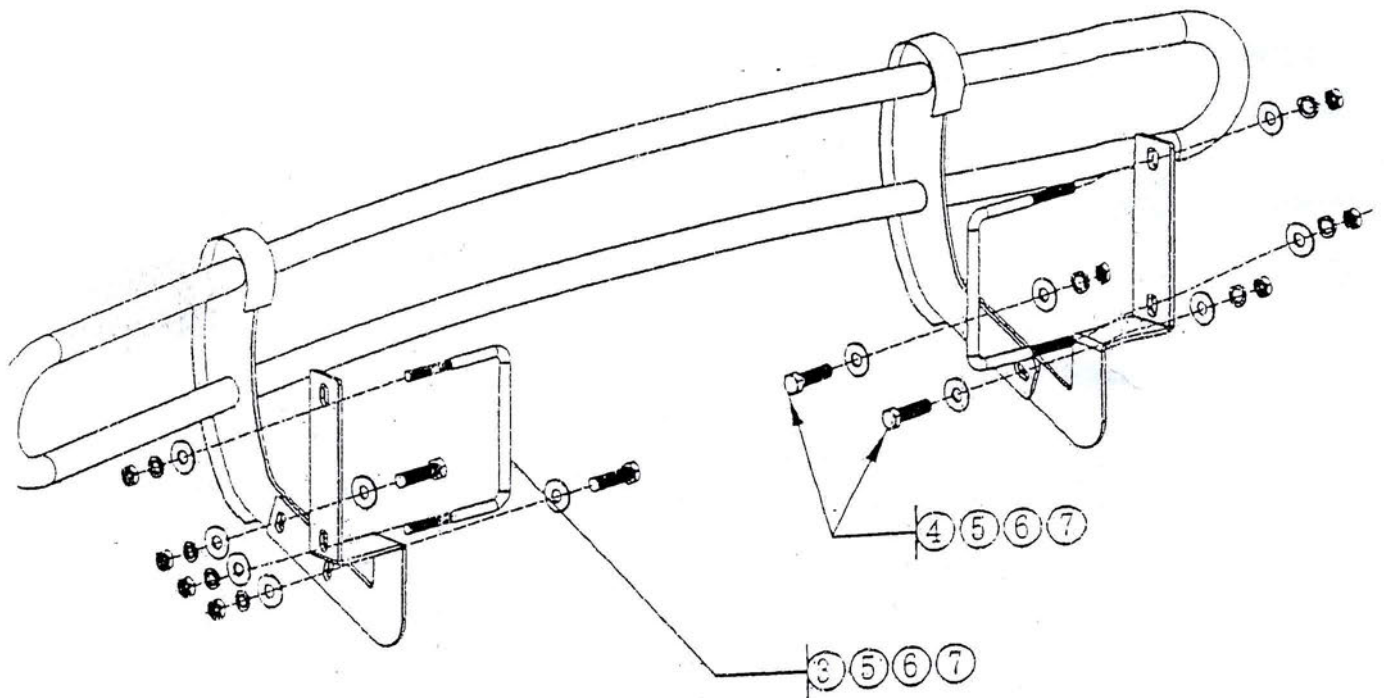

- 
- 1: Check the parts in the box carefully if match above list.
  - 2: Pls prepare the tools for installation, follow as: 17-19 wrench.
  - 3: Install the mount bracket on the girder of the car, and tighten it with M12 "U" Bolt with bread.
  - 4: Install the Rear guard the mount bracket, and tighten it with M12X30 bolt.
  - 5: Installation is finished.