

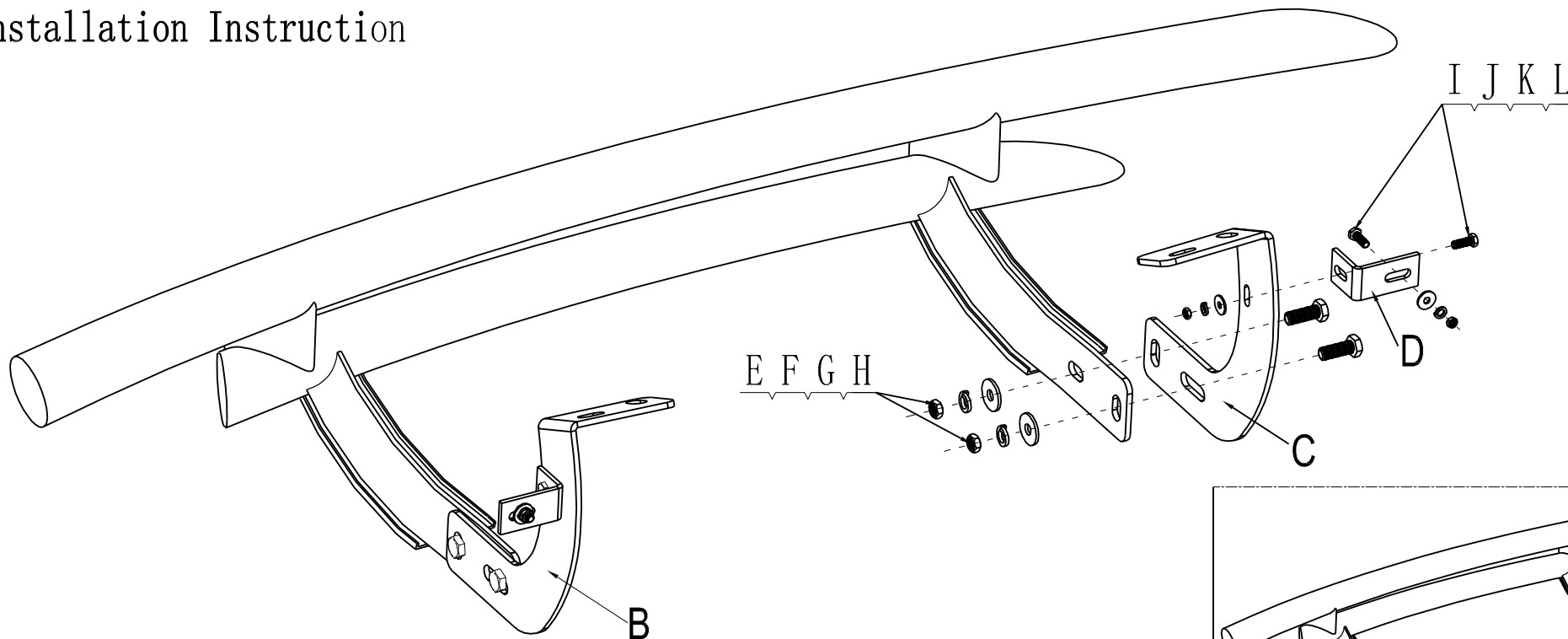

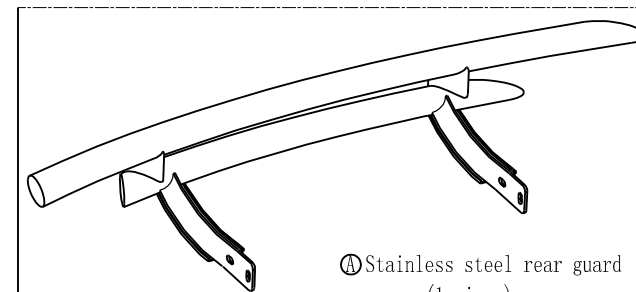





# BZ-B019A Rear Guard Installation Instruction

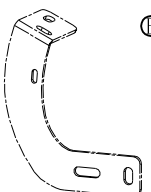
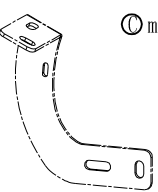
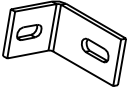
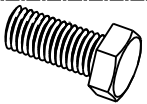

## Parts list:

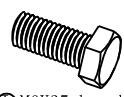

Ⓐ Stainless steel rear guard  
(1 piece)

 <p>Ⓑ mount bracket 1 (1 piece)</p>	 <p>Ⓒ mount bracket 2 (1 piece)</p>	 <p>Ⓓ mount bracket 3 (2 pieces)</p>	
 <p>Ⓘ M12X25 hex head bolt(4 pieces)</p>	 <p>Ⓚ M12 flat washer (4 pieces)</p>	 <p>Ⓛ M12 lock washer (4 pieces)</p>	 <p>Ⓜ M12 nut (4 pieces)</p>
 <p>Ⓟ M6X25 hex head bolt(4 pieces)</p>	 <p>Ⓨ M6 flat washer (4 pieces)</p>	 <p>Ⓩ M6 lock washer (4 pieces)</p>	 <p>ⓐ M6 Nut (4 pieces)</p>

## INSTALLATION STEPS:

STEP 1. Check the parts in the box carefully if match above list.

STEP 2. Pls prepare the tools for installation, follow as: 10-12wrench, 17-19wrench.

STEP 3. Put the mount bracket 1(B) and the mount bracket 2(C) on the girder of the car, then tighten it with original bolt.

STEP 4. Put the bracket 3(D) on the girder of the car, and tighten it with M6X25 bolt(I);  
Connect the bracket 3(D) and the mount bracket 1(B) with M6X25 bolt(I), and tighten it;  
Connect the bracket 3(D) and the mount bracket 2(C) with M6X25 bolt(I), and tighten it.

STEP 5. Install the rear guard(A) on the mount bracket 1(B) and the mount bracket 2(C) then tighten it with M12X25 hex head bolt(E).