

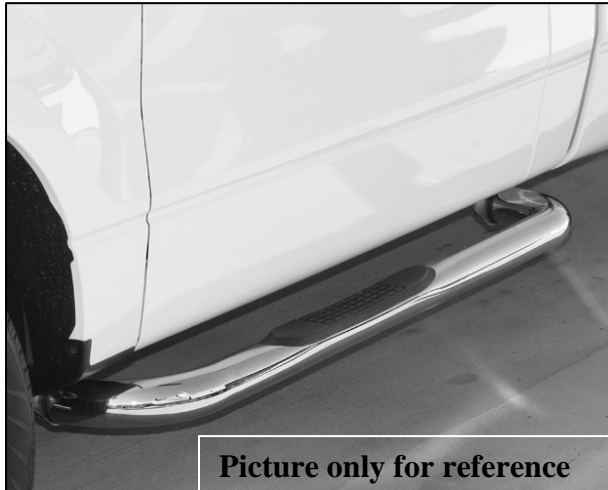

INSTALLATION INSTRUCTIONS

PART#: 9B290801SS\9B290801A

SIDE BAR FOR FORD F-150 REG CAB 2009



Picture only for reference

PARTS LIST:

1	Driver/Left Sidebar	4	12mm ID x 30.1mm OD x 3mm Flat Washers
1	Passenger/Right Sidebar	4	12mm Lock Washers
1	Driver/Left Front Mounting Bracket	4	12mm Hex Nuts
1	Passenger/Right Front Mounting Bracket	4	10-1.50mm x 35mm Hex Bolts
1	Driver/Left Rear Mounting Bracket	6	10mm x 30mm OD x 2.5mm Flat Washers
1	Passenger/Right Rear Mounting Bracket	4	10mm Lock Washers
2	12mm x 40mm x 10mm Nut and Bolt Plate	2	10mm Hex Nuts
2	12mm x 40mm Bolt Plates	4	8-1.25mm x 30mm Hex Head Bolts
4	12mm Plastic Retainers	4	8mm ID x 24mm OD x 2mm Flat Washers (Outer)
2	10mm Plastic Retainers	4	8mm ID x 16mm OD x 1.6mm Flat Washers (Inner)
4	1/2" x 2" Hex Head Bolts	4	8mm Lock Washers
4	1/2" x 1-1/2" OD x 18" Flat Washers	4	8mm Hex Nuts
4	1/2" Lock Washers		

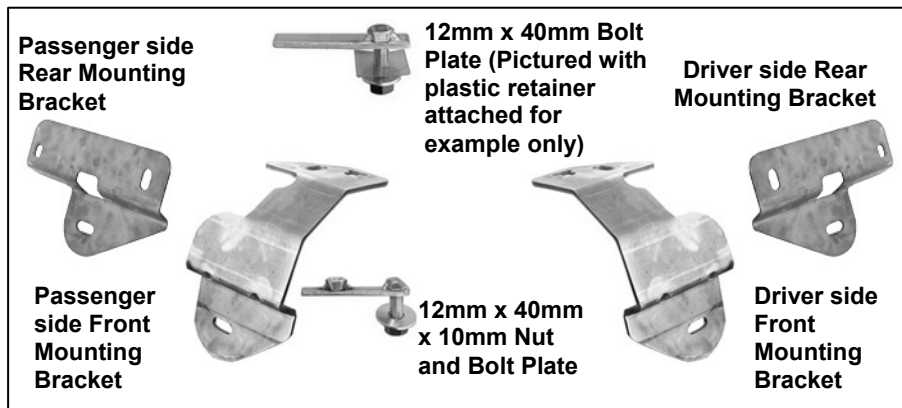
**PROCEDURE:**

- REMOVE CONTENTS FROM BOX. VERIFY ALL PARTS ARE PRESENT. READ INSTRUCTIONS CAREFULLY BEFORE STARTING INSTALLATION. DRILLING IS REQUIRED. ASSISTANCE RECOMMENDED.**
- Starting at the front of the driver side of the vehicle, remove the plastic pin, the two small hex bolts and the metal clips holding the bottom of the fender to the body, **(Figure 1A)**. **NOTE:** Use a small flat screwdriver to spread the clip apart for easy removal. Due to body panel misalignment from the factory, it may be necessary to open these holes slightly with a 3/8" drill bit, **(Figure 1B)**.
- Next, locate the round and square holes in the floor panel next to the body mount, **(Figure 2)**. Select (1) 12mm x 40mm x 10mm Nut and Bolt Plate and thread (1) 11mm Plastic Retainer part way onto it. Insert the Nut and Bolt Plate into the square hole in the floor. Line up the nut on the Nut and Bolt Plate with the round hole. **IMPORTANT:** The Plastic Retainer is designed to prevent the Bolt Plate from falling into the body cavity and to aid in mounting the Bracket. After inserting, thread the Plastic Retainer down but leave it loose enough to move the Nut and Bolt Plate around during installation of the Mounting Bracket. **NOTE:** For passenger side installation, remove the ground strap next to the mounting holes.
- Select the driver side front Mounting Bracket and hold it at a slight angle against the body. Move the top of the Bracket into position with the threaded end of the Nut and Bolt Plate lined up with the T-Slot in the Bracket. The top of the Bracket is designed to fit snug in position between the body mount and the lip on the body so it may take a couple of tries to get the Bracket into the correct position, **(Figure 3)**. Once the top of the Bracket is properly lined up in the T-Slot, rotate the bottom of the Bracket into position with the holes in the pinch weld. Secure the 12mm threaded end of the Nut and Bolt Plate with (1) 12mm Flat Washer, (1) 12mm Lock Washer and (1) 12mm Hex Nut. Rotate the Nut and Bolt Plate

around to line up the Nut with the remaining hole and thread (1) 10mm x 35mm Hex Bolt, (1) 10mm Flat Washer and (1) 10mm Lock Washer into the Nut, **(Figure 4)**. Do not tighten at this time.

5. Align the holes in the pinch weld with the holes in the front Mounting Bracket. Insert (2) 8mm x 30mm Hex Bolts with (2) 8mm x 24mm OD x 2mm Large Flat Washers up from below and secure with (2) 8mm x 16mm OD x 1.6mm Small Flat Washers, (to clear the bracket), (2) 8mm Lock Washers and (2) 8mm Hex Nuts, **(Figure 5)**. Do not tighten at this time.
6. Moving to the driver side rear, remove the tape covering the holes on the inner body panel.
 - a. **REGULAR CAB:** Select (1) 12mm Bolt Plate and thread (1) 12mm Plastic Retainer part way onto it. Insert the Bolt Plate and Retainer into the rear mounting hole, **(Figure 6)**. **IMPORTANT:** The Plastic Retainer is designed to prevent the Bolt Plate from falling into the body cavity and to aid in mounting the Bracket. Once inserted, thread the Plastic Retainer all of the way down to snug up against the body.
 - b. **SUPERCAB:** Select (1) 12mm Bolt Plate and insert it into the larger of the two holes in the body panel and back out the smaller hole. Thread (1) 12mm Plastic Retainer all the way onto it until it is snug against the body, **(Figure 7)**. **IMPORTANT:** The Plastic Retainer is designed to prevent the Bolt Plate from falling into the body cavity and to aid in mounting the Bracket. Once inserted, thread the Plastic Retainer all of the way down to snug up against the body.
7. Hang the driver side Rear Mounting Bracket from the Bolt Plate and Retainer and secure it with the included (1) 12mm Lock Washer, (1) 12mm Flat Washer, and (1) 12mm Hex Nut, **(Figure 6&7)**. Insert (1) 10mm x 35mm Hex Bolt, (1) 10mm Flat Washer with (1) 10mm Plastic Retainer into the hole at the rear of the Mounting Bracket from the outside-in, **(Figure 8)**. **NOTE:** The Plastic Retainer is intended to protect the outer painted surface of the body. Thread the Plastic Retainer onto the Hex Bolt so that it is between the 10mm Flat Washer and the body. Secure the Bracket with (1) 10mm Lock Washer, (1) 10mm Flat Washer and (1) 10mm Hex Nut. Do not tighten hardware at this time.
8. Attach the Sidebar to the Mounting Brackets using the included (2) 1/2" x 2" Hex Head Bolts, (2) 1/2" Flat Washers, and (2) 1/2" Lock Washers. Do not tighten hardware at this time.
9. Align the Sidebar and adjust as required. Once properly aligned, tighten all hardware.
10. Repeat steps 2-9 for passenger Sidebar installation. **NOTE:** For passenger side installation, replace the ground strap next to the mounting holes for the front Mounting Bracket removed in Step 3.
11. Do periodic inspections to the installation to make sure that all hardware is secure and tight.

To protect your investment, wax this product after installing. Regular waxing is recommended to add a protective layer over the finish. Do not use any type of polish or wax that may contain abrasives that could damage the finish.

For stainless steel: Aluminum polish may be used to polish small scratches and scuffs on the finish. Mild soap may be used also to clean the Sidebar.

For gloss black finishes: Mild soap may be used to clean the Sidebar.

Driver Side Installation Pictured

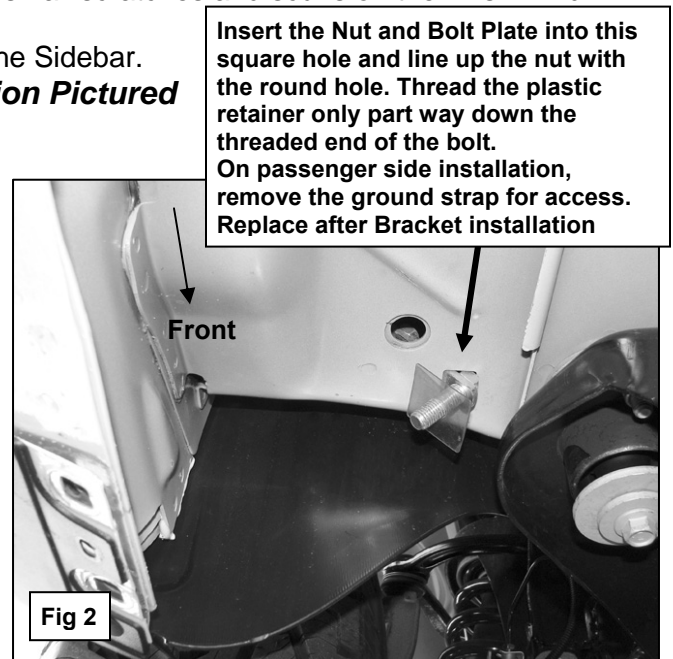
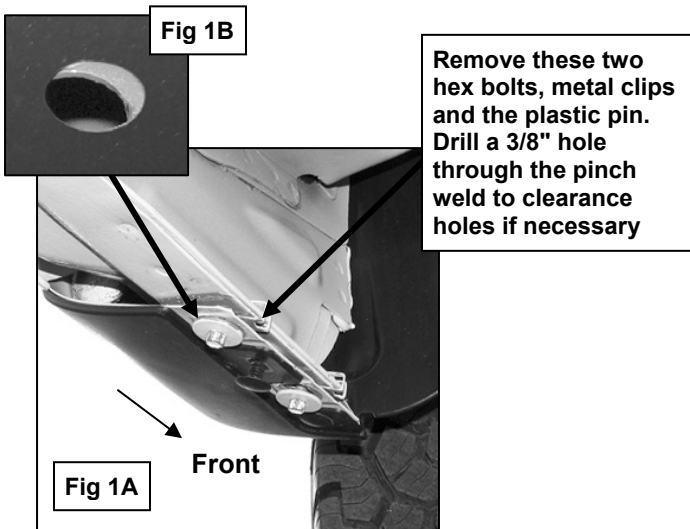

Driver Side Installation Pictured



Hold Bracket in place on top of this lip on the body

Hold the Bracket at an angle. Insert the top of the Bracket between this lip on the body and the body mount. Line up the threaded Nut and Bolt Plate with the T-Slot in the Bracket

Fig 3

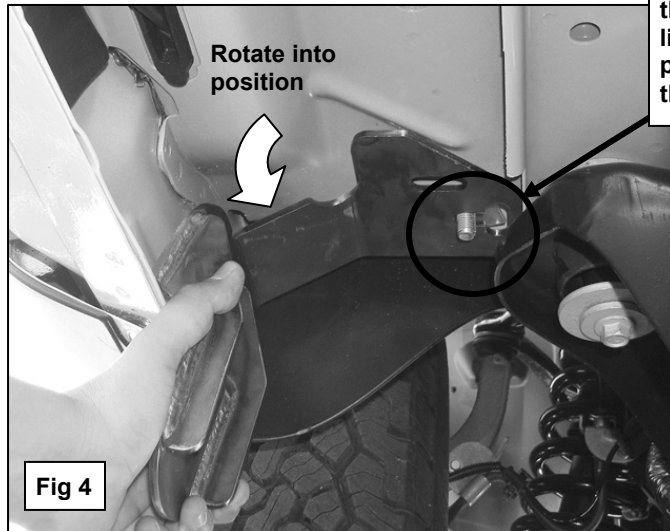

Rotate into position

Once properly lined up, rotate the Bracket into position and line up with the holes in the pinch weld then pull the bolt through the top of the Bracket

Fig 4

- (1) 10mm x 35mm Hex Bolt
- (1) 10mm Flat Washer
- (1) 10mm Lock Washer

- (1) 12mm x 40mm x 10mm Nut and Bolt Plate
- (1) 11mm Plastic Retainer
- (1) 12mm Flat Washer
- (1) 12mm Lock Washer
- (1) 12mm hex Nut

- (2) 8mm x 30mm Hex Bolts
- (2) 8mm Lock Washers
- (2) 8mm x 24mm OD Large Flat Washers (outer)
- (2) 8mm x 16mm OD Small Flat Washers (inner against Bracket)
- (2) 8mm Hex Nuts

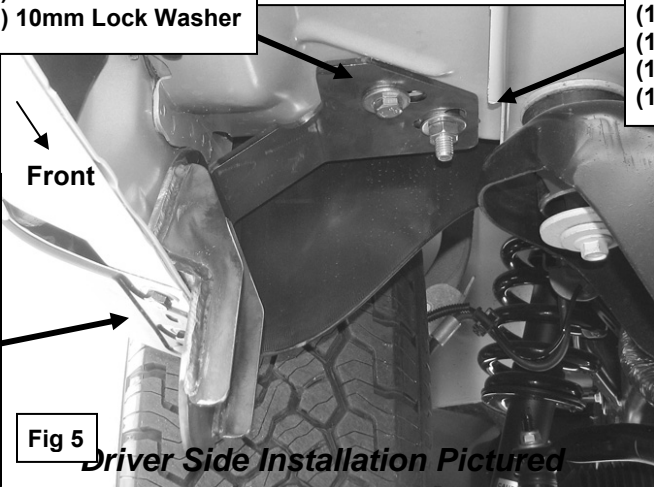

Fig 5

Driver Side Installation Pictured

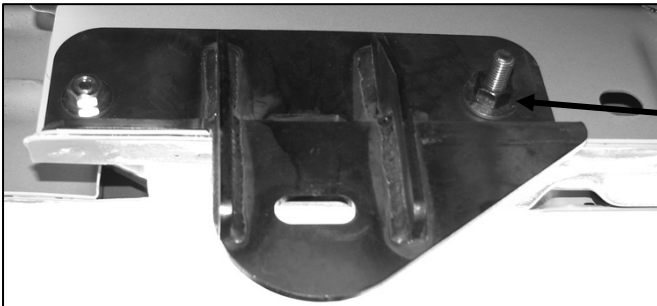
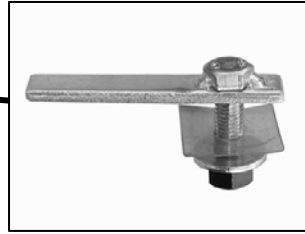

Fig 6

← Rear

Regular Cab rear mounting location pictured. Thread the Plastic Retainer onto the Bolt Plate then insert the Bolt Plate into the large hole in the body. Continue to thread the Plastic Retainer down until it is snug against the body



12mm Bolt Plate with Plastic Retainer
12mm Flat Washer
12mm Lock Washer
12mm Hex Nut

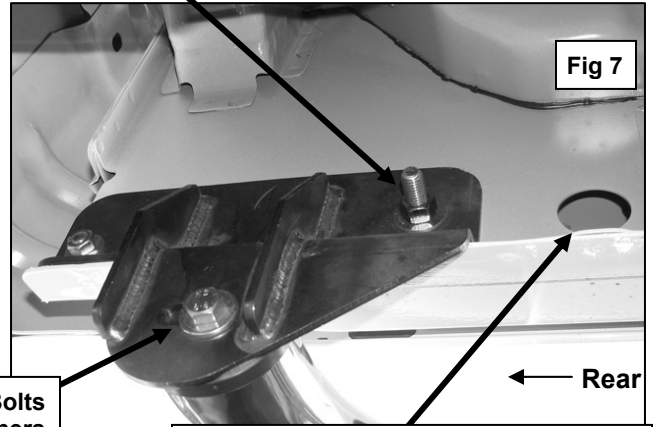
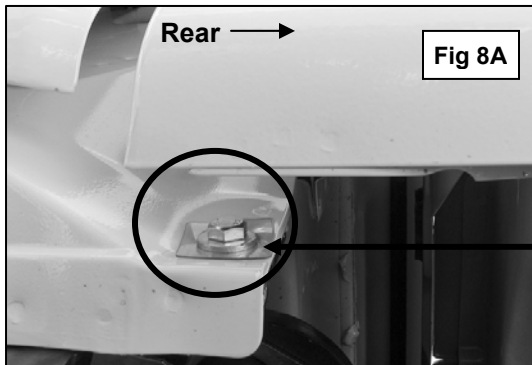

Fig 7

← Rear

1/2" x 2" Hex Bolts
1/2" Lock Washers
1/2" Flat Washers

Super Cab rear mounting location pictured. Insert the Bolt Plate in through the large hole and back out through the smaller hole in the body then thread the Plastic Retainer onto the Bolt Plate



Rear →

Fig 8A

Rear bolt on Rear Mounting Bracket pictured from outside of vehicle. Place the Plastic Washer between the 10mm Flat Washer and the painted surface of the truck body

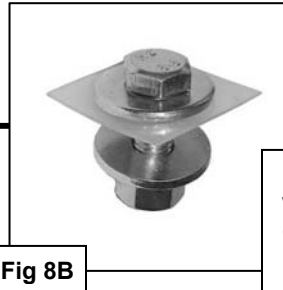

Fig 8B

10mm x 35mm Hex Bolt with Plastic Retainer
(2) 10mm Flat Washers
10mm Lock Washer
10mm Hex Nut



Regular Cab complete installation



Super Cab complete installation