



INSTALLATION
INSTRUCTIONS [SIDE BAR](#) FOR HONDA
CRV 2012

PART # 9B150503A \ 9B150503SS

PARTS LIST:

1	Driver/Left Sidebar
1	Passenger/Right Sidebar
1	Driver/Left Front Mounting Bracket
1	Passenger/Right Front Mounting Bracket
1	Driver/Left Rear Mounting Bracket
1	Passenger/Right Rear Mounting Bracket
20	8-1.25mm x 30mm Hex Bolts
20	8mm Lock Washers
20	8mm x 24mm OD x 2mm Flat Washers

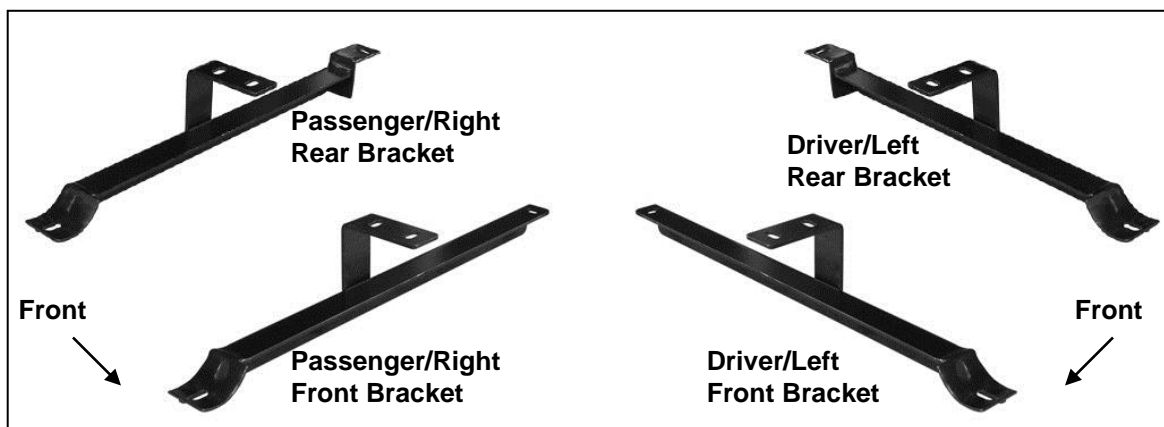

PROCEDURE:

- 1. REMOVE CONTENTS FROM BOX. VERIFY ALL PARTS ARE PRESENT. READ INSTRUCTIONS CAREFULLY BEFORE STARTING INSTALLATION. CUTTING IS REQUIRED.**
- Identify and separate the driver and passenger side Mounting Brackets. Start installation on the driver/left side of the vehicle. Remove the plastic cover under the driver side of the vehicle, **(Figure 1)**.
- Locate the (2) 8mm threaded holes in the floor panel next to the pinch weld toward the front of the vehicle. Also locate the threaded holes in the bottom of the inner frame channel in line with the outer holes, **(Figure 1)**. **IMPORTANT:** There are (4) threaded holes at each mounting location, (2) inner on bottom of frame channel and (2) outer next to pinch weld. The single slot in the inner mounting tab on the Brackets will line up with the threaded hole towards the rear of vehicle. **NOTE:** These threaded holes are also used by the vehicle manufacturer for OE running board installation.
- Hold the driver side front Bracket up in place to verify the location of the correct threaded holes, **(Figures 1 & 5)**. Repeat to verify the rear mounting bracket location on the vehicle. Mark the front and rear mounting locations with a marker for reference.
- Cut out the paper template on **Page 4** labeled "Driver Side," **(Figure 2)**. Cut out the square section on the bottom and the (2) 8mm holes on the top of the template, **(Figure 3)**. Temporarily reinstall the plastic cover, (fasten clips/screws toward outside only). Hold the template up to the outer (2) factory 8mm threaded holes next to the pinch weld as identified in **Step 3, (Figure 4)**. Use a marker to trace the cut out section on the bottom of the template onto the plastic cover. Repeat this Step to mark the rear bracket location.
- Remove the plastic cover. Cut out the (2) sections as marked. **IMPORTANT:** The templates have been provided for reference use only. It is the installer's responsibility to be absolutely sure that the correct location has been marked before cutting the plastic cover.
- Select the driver side Front Bracket. Insert the bracket through the hole cut in the cover. Attach the outer end of the driver side front Mounting Bracket to the (2) threaded holes next to the pinch weld with the included (2) 8mm Hex Bolts, (2) 8mm Lock Washers, and (2) 8mm Flat Washers, **(Figure 5)**. Attach the inner tab on the bracket to the threaded hole in the bottom of the inner frame channel with the

included (1) 8mm Hex Bolt, (1) 8mm Lock Washer, and (1) 8mm Flat Washer, (**Figure 6**). Leave hardware loose at this time.

8. Move to the back of the vehicle and repeat **Steps 7 – 8** for rear Bracket installation, (**Figure 7**).
9. Leave the plastic cover loose and slowly tighten the hardware bolting the Brackets to the vehicle.
NOTE: It may be necessary to completely remove the Brackets and cover if the cover requires additional cutting. Leave plastic cover loose at this time.
10. Carefully position the Driver/Left Sidebar onto the (2) Mounting Brackets. Attach the Sidebar to the Mounting Brackets using the included (4) 8mm Hex Bolts, (4) 8mm Lock Washers and (4) 8mm Flat Washers, (**Figure 8**). Do not tighten at this time.
11. Level and adjust the Sidebar and tighten all hardware.
12. Once all hardware has been completely tightened, reinstall the plastic cover with the factory hardware.
13. Repeat **Steps 2 – 12** for passenger Sidebar installation.
14. Do periodic inspections to the installation to make sure that all hardware is secure and tight.

To protect your investment, wax this product after installing. Regular waxing is recommended to add a protective layer over the finish. Do not use any type of polish or wax that may contain abrasives that could damage the finish.

For stainless steel: Aluminum polish may be used to polish small scratches and scuffs on the finish. Mild soap may be used also to clean the Sidebar.

For gloss black finishes: Mild soap may be used to clean the Sidebar.

Driver Side Installation Pictured Without Plastic Cover for Instruction Purposes Only

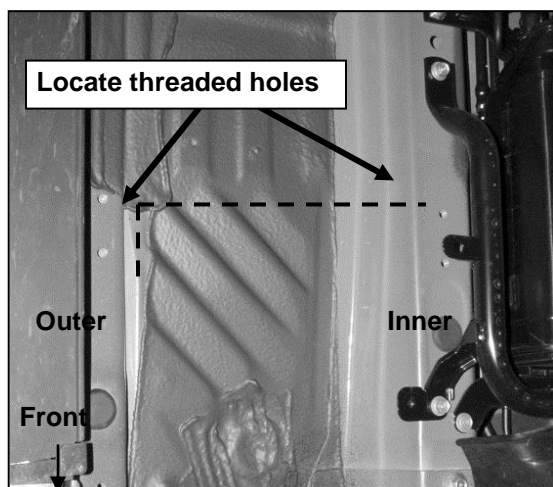

(Fig 1) Driver Side Front Mounting Location Pictured

Cut out square and (2) round holes

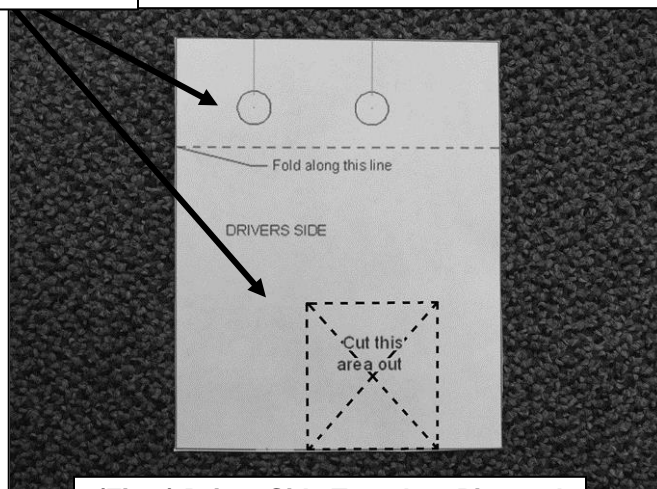

(Fig 2) Driver Side Template Pictured

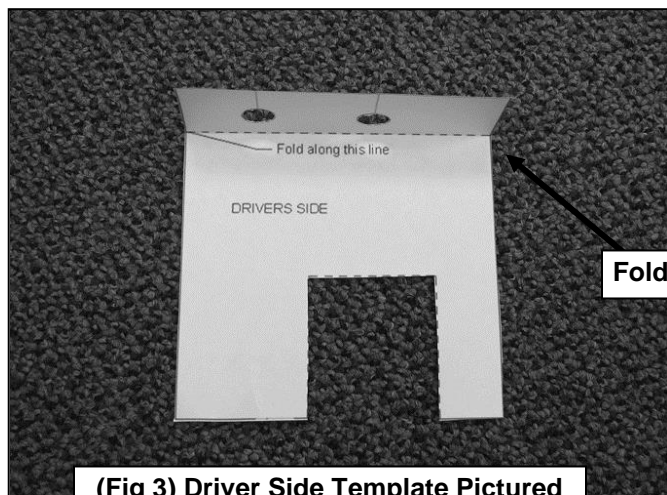

(Fig 3) Driver Side Template Pictured

Fold along dashed line

Driver Side Installation Pictured Without Plastic Cover for Instruction Purposes Only

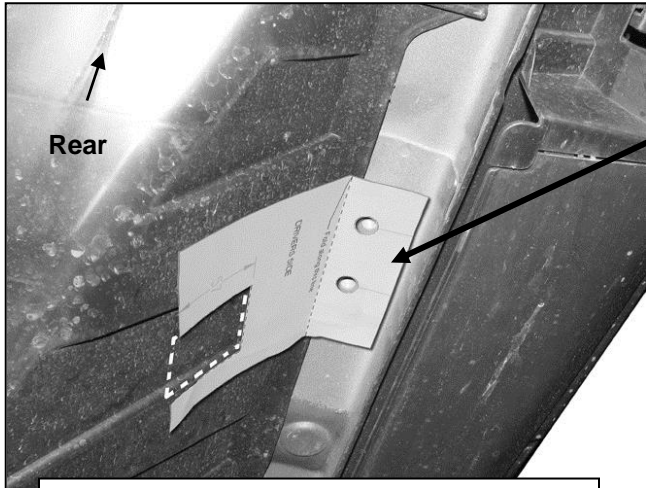

(Fig 4) Rear Driver Side Location Pictured

With the plastic cover in place, hold the paper template (Driver side pictured) over the (2) threaded holes next to the pinch weld. Use a marker to trace the square cut out section on the template. Use a utility knife or hacksaw to carefully cut out this section. Check the clearance between the Bracket and the cover often for proper fit

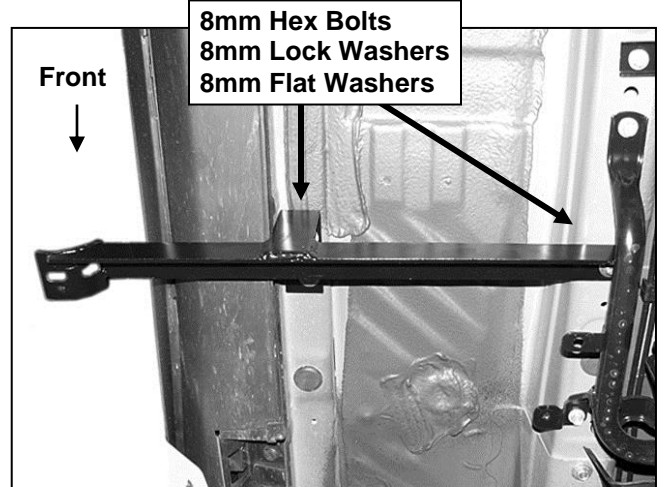

(Fig 5) Driver Side Front Mounting Bracket Pictured

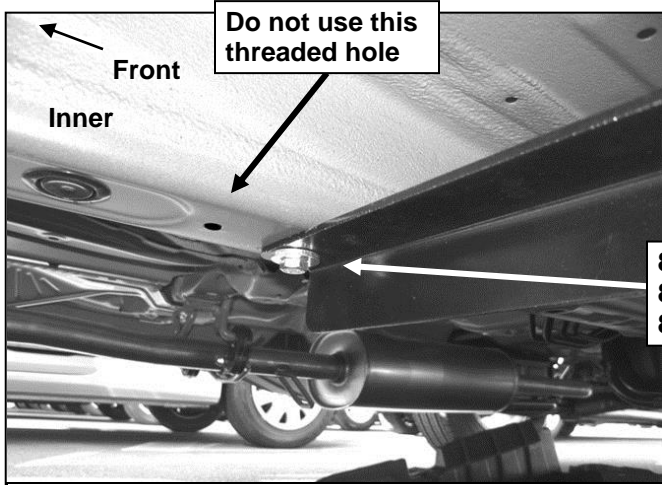

(Fig 6) Driver Side Front Mounting Bracket Pictured

8mm Hex Bolts
8mm Lock Washers
8mm Flat Washers

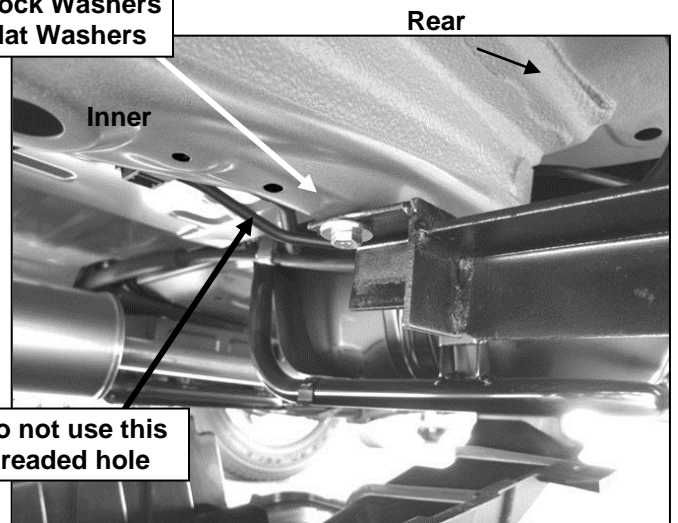

(Fig 7) Driver Side Rear Mounting Bracket Pictured



(Fig 8) Driver Side Front Mounting Bracket Pictured

8mm Hex Bolts
8mm Lock Washers
8mm Flat Washers

