



INSTALLATION INSTRUCTIONS

PART # 9B093905SS/9B093905A SIDE BAR
FOR TOYOTA RAV4 2013

PARTS LIST:

Qty	Description	Qty	Description
1	Driver/Left Tube Assembly	2	10-1.50mm x 40mm Carriage Bolts
1	Passenger/Right Tube Assembly	2	10mm Rectangular Washers
1	Driver/Left Front Mounting Bracket	2	10-1.50mm x 35mm Hex Bolt
1	Passenger/Right Front Mounting Bracket	10	10mm x 27mm x 3mm Flat Washer
1	Driver/Left Front Support Bracket	8	10mm Lock Washer
1	Passenger/Right Front Support Bracket	8	10-1.5mm Hex Nut
1	Driver/Left Rear Bracket	8	8-1.25mm x 25mm Hex Bolt
1	Passenger/Right Rear Bracket	8	8mm x 24mm x 2mm Flat Washer
4	10-1.5mm x 50mm T-Bolt	8	8mm Lock Washer
6	10mm Plastic Retainers		

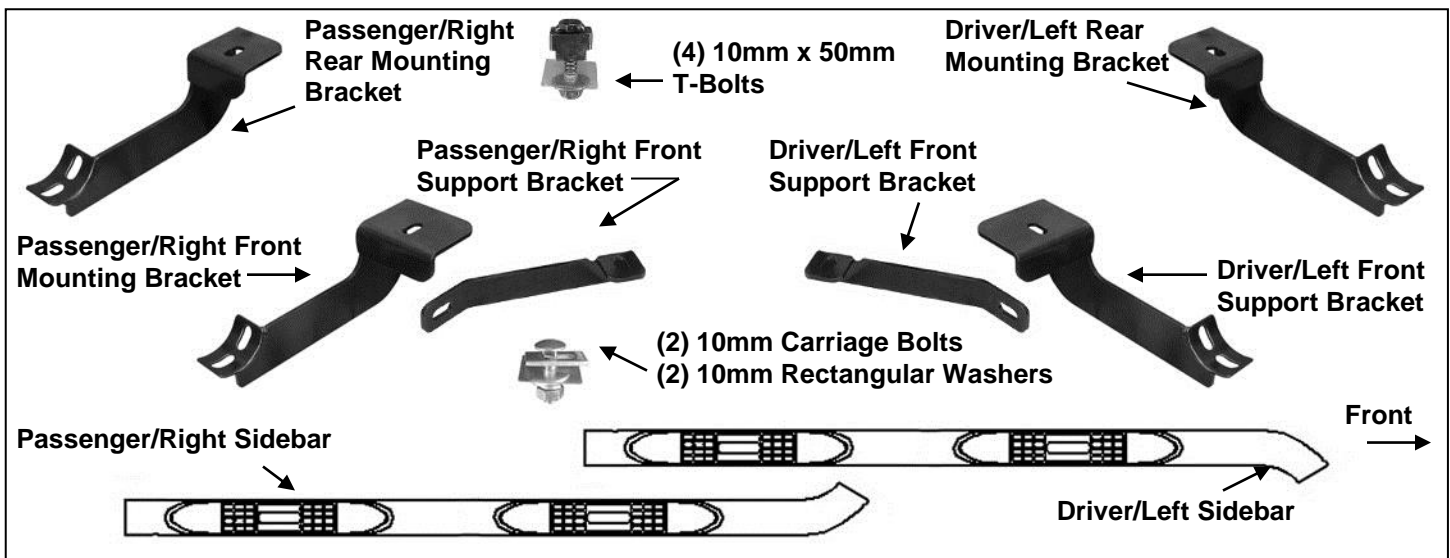

PROCEDURE:

- 1. REMOVE CONTENTS FROM BOX. VERIFY ALL PARTS ARE PRESENT. READ INSTRUCTIONS CAREFULLY BEFORE STARTING INSTALLATION.**
- Starting on the driver side of the vehicle, locate and remove the factory round and oval rubber plugs in the bottom of the body panel located closest to the front tire opening, **(Figures 1 & 2)**. Select (1) 10mm x 45mm Carriage Bolt, (1) 10mm Rectangular Washer and (1) 10mm Plastic Retainer, **(Figure 3A)**. Slide the Rectangular Washer onto and over the square shoulder on the Carriage Bolt. Thread the Retainer part way onto the Bolt. **NOTE:** The Plastic Retainer is designed to help hold the Bolt in place during Bracket installation. Insert the Carriage Bolt with Rectangular Washer and Retainer into the inner round hole in the floor panel. Line up the Carriage Bolt with the center of the hole and the Rectangular Washer across the hole. Pull the Carriage Bolt down through the slot in the Washer. Thread the Retainer down tight against the floor panel, **(Figure 3B)**.
- Select (1) T-Bolt and (1) 10mm Plastic Retainer, **(Figure 4A)**. Insert the T-Bolt up into the oval hole and rotate it 90-degrees so that the block is across the oval hole. Thread the Plastic Retainer onto the T-Bolt and tight against the floor panel, **(Figure 4B)**.
- Next, select the driver side Front Bracket. Secure the Front Bracket to the T-Bolt first with (1) 10mm Flat Washer, (1) 10mm Lock Washer and (1) 10mm Hex Nut, **(Figure 5)**. Snug but do not tighten the hardware at this time.

5. Select the driver side Front Support Bracket. Bolt the Support Bracket to the inner 10mm Carriage Bolt with (1) 10mm Flat Washer, (1) 10mm Lock Washer and (1) 10mm Hex Nut, **(Figures 5)**. Leave hardware loose. Line up the slot in the Support Bracket with the slot in the Front Mounting Bracket. Bolt the Support Bracket to the front of the Mounting Bracket with (1) 10mm x 35mm Hex Bolt, (2) 10mm Flat Washers, (1) 10mm Lock Washer and (1) 10mm Hex Nut. Snug but do not tighten hardware at this time.
6. Move along the side of the vehicle to the rear mounting location, **(Figure 6)**. Remove the oval rubber plug. Select (1) T-Bolt and (1) 10mm Plastic Retainer, **(Figure 7A)**. Insert the T-Bolt up into the oval hole and rotate 90-degrees so that the block is across the oval hole. Thread the Plastic Retainer onto the T-Bolt and tight against the floor panel as described in **Step 2, (Figure 7B)**.
7. Select the driver side Rear Mounting Bracket. Hang the Rear Bracket from the T-Bolt with (1) 10mm Flat Washer, (1) 10mm Lock Washer and (1) 10mm Hex Nut, **(Figure 8)**. Snug but do not tighten the hardware at this time.
8. Select and unwrap the driver Sidebar. Carefully place the Sidebar onto the two Brackets. Line up the threaded inserts in the bottom of the Sidebar with the cradles on the Brackets. Bolt the Sidebar to the Brackets with (4) 8mm x 25mm Hex Bolts, (4) 8mm Lock Washers and (4) 8mm Flat Washers, **(Figures 8 & 9)**. Do not tighten hardware.
9. Align and adjust the Sidebar Brackets as necessary and tighten all hardware
10. Repeat **Steps 2 – 9** for the passenger Sidebar installation.
11. Do periodic inspections to the installation to make sure that all hardware is secure and tight.

To protect your investment, wax this product after installing. Regular waxing is recommended to add a protective layer over the finish. Do not use any type of polish or wax that may contain abrasives that could damage the finish.

For stainless steel: Aluminum polish may be used to polish small scratches and scuffs on the finish. Mild soap may be used also to clean the Sidebar.

For gloss black finishes: Mild soap may be used to clean the Sidebar.

Driver Side Installation Pictured

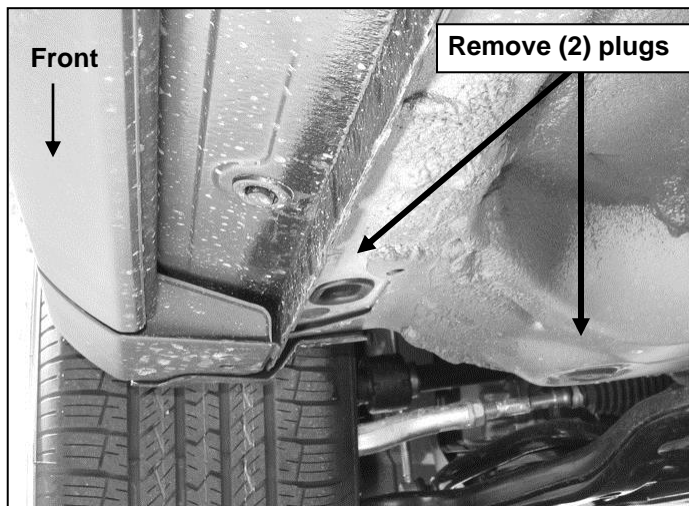

(Fig 1) Driver side front mounting location pictured

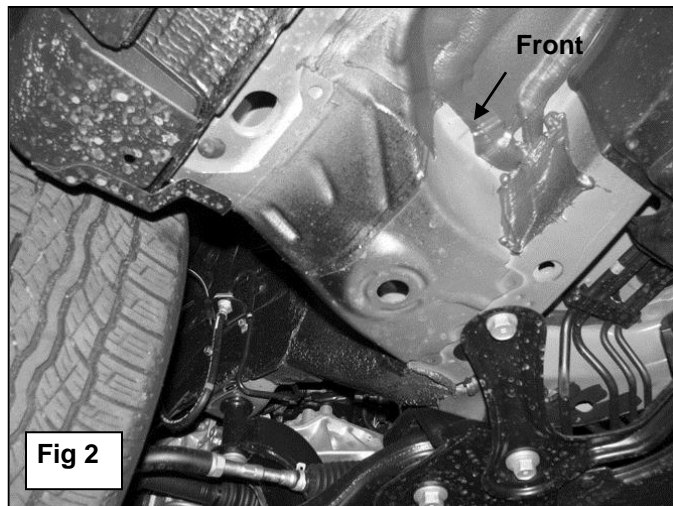
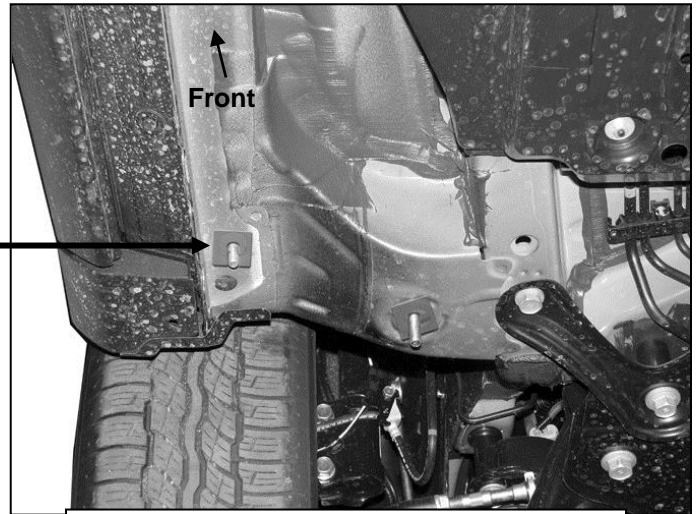
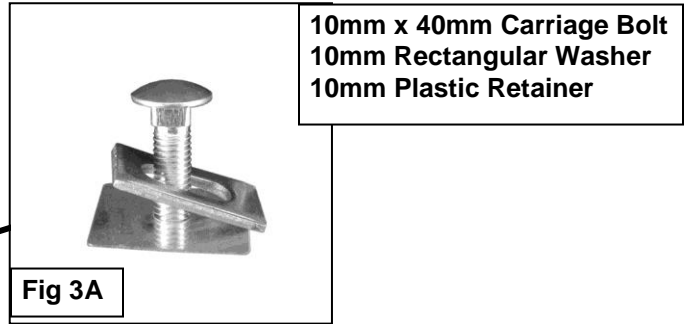
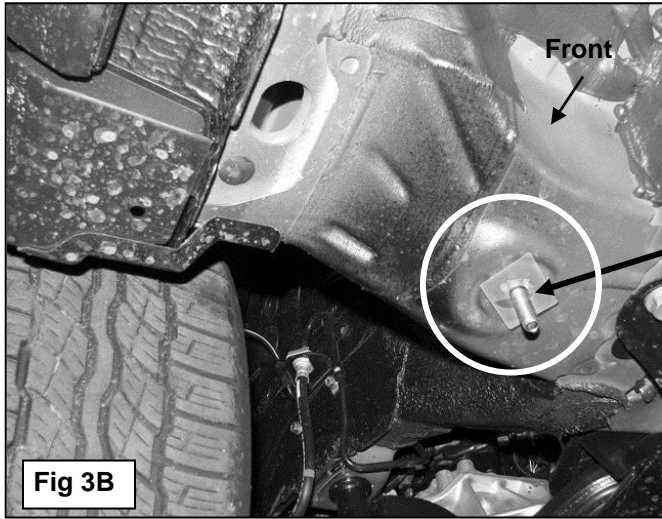
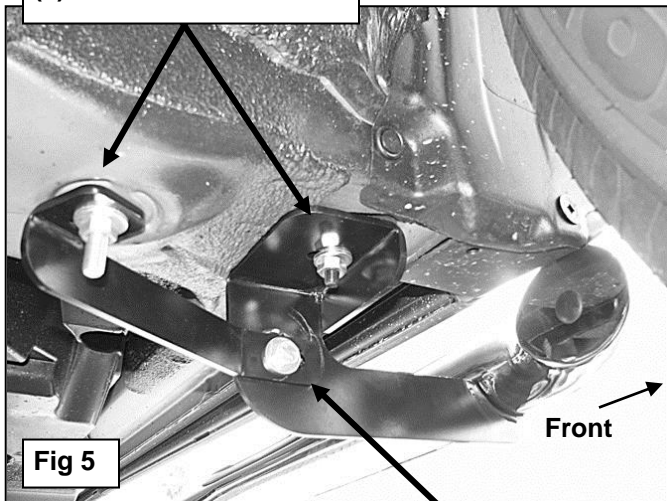

Fig 2

Driver Side Installation Pictured



- (2) 10mm Flat Washers
- (2) 10mm Lock Washers
- (2) 10mm Hex Nuts



- 10mm x 35mm Hex Bolt
- (2) 10mm Flat Washers
- 10mm Lock Washer
- 10mm Hex Nut

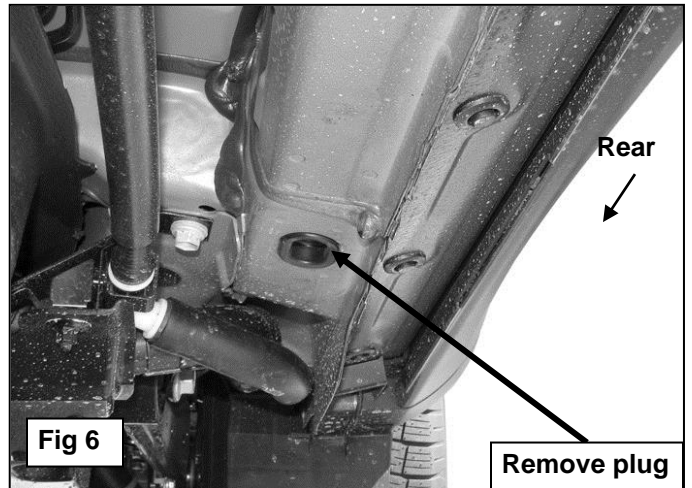

Driver Side Installation Pictured

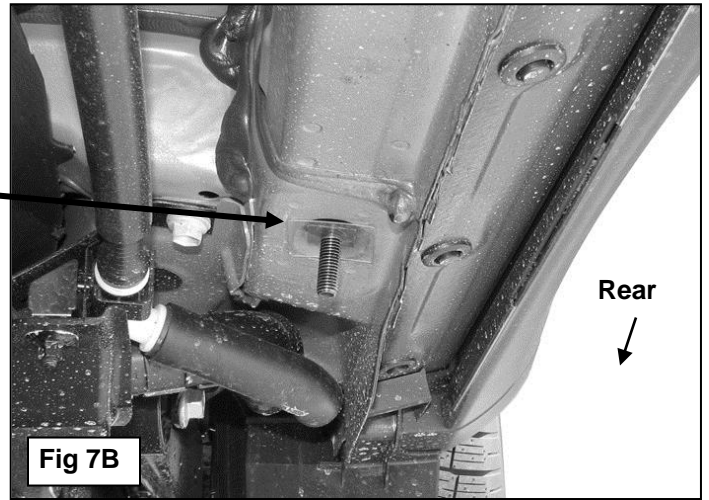

- 10mm Flat Washer
- 10mm Lock Washer
- 10mm Hex Nut

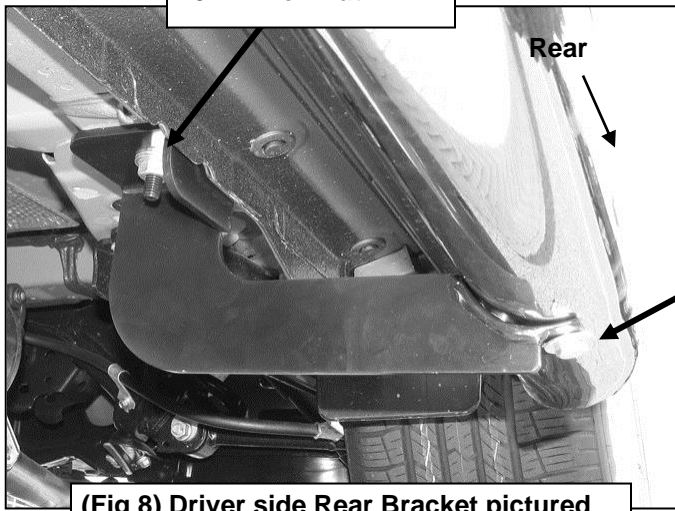

- (2) 8mm x 25mm Hex Bolts
- (2) 8mm Lock Washers
- (2) 8mm x 24mm Flat Washers

