



INSTALLATION INSTRUCTION













GRILLE GUARD FOR TOYOTA SIENNA 2010

ITEM NO: BBTY918A

ATTENTION

1. Please read this installation instruction before installing this part. When install it, please pay attention to protecting your vehicles.
2. When you use it, please check this parts at a fix time-lapse, such as one month or two month.

PARTS LIST

No	Name	Photo	Qty	Remarks	No	Name	Photo	Qty	Remarks
A	Grille Guard		1		H	Lock washer		6	M12
B	mount bracket1		2	lateral symmetry	I	Hex Nut		4	M12
C	mount bracket2		2	lateral symmetry	J	"U"Bolt		2	M8X25
D	Hex Bolt		2	M12X35	K	flat washer		4	M8
E	Hex Bolt		2	M12X25	L	Lock washer		4	M8
F	M10" T " Hex Bolt		2	M12X40	M	Hex Nut		4	M8
G	flat washer		6	M12					

INSTALLATION STEPS

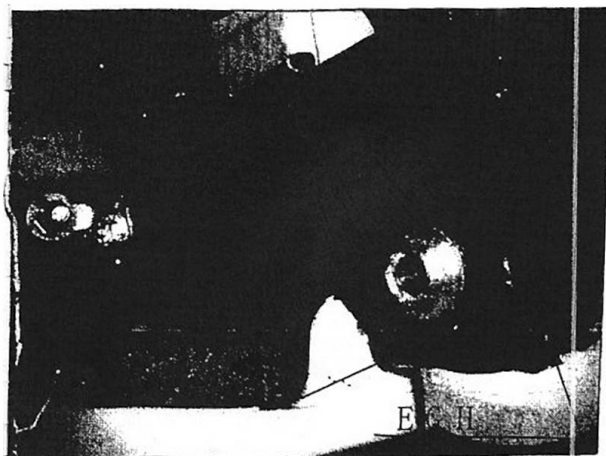
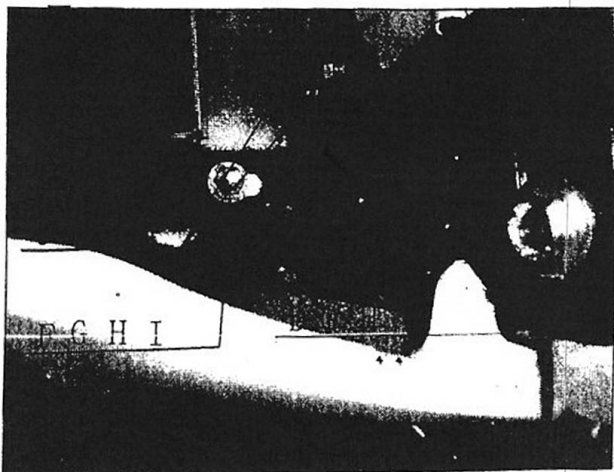

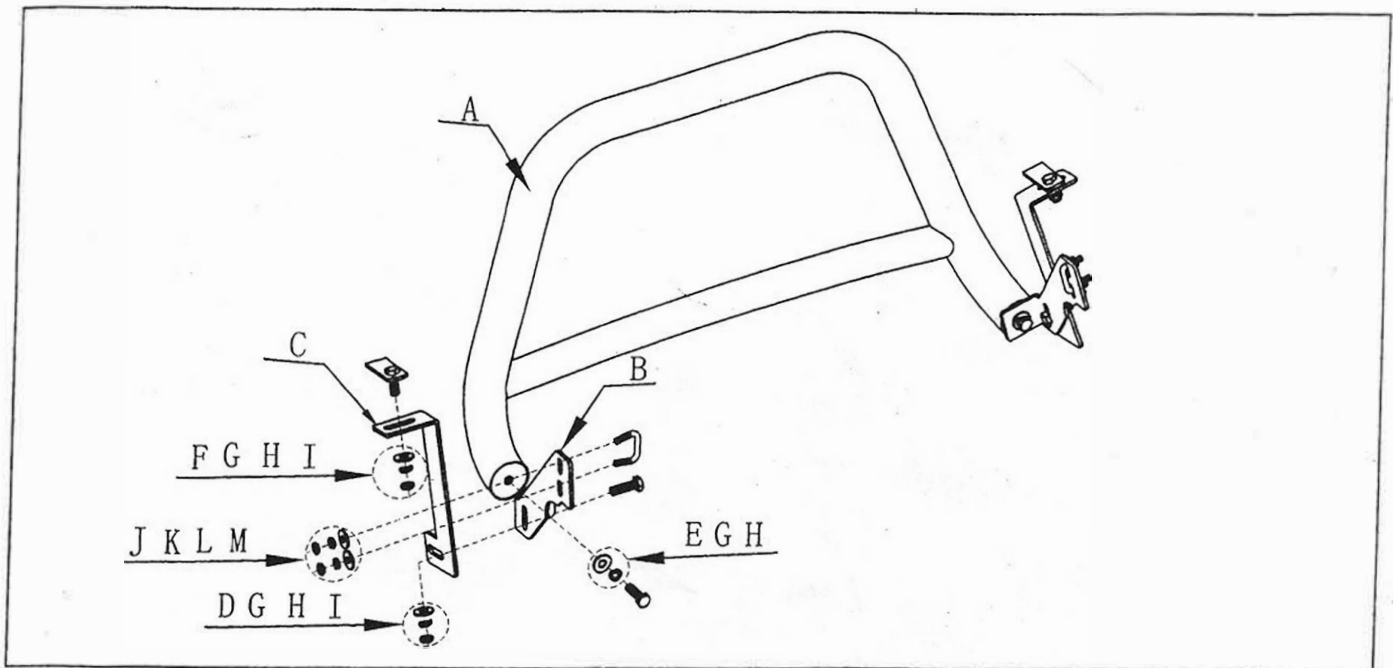

STEP 1: Check the parts in the box carefully if match above parts list .

STEP 2: Pls prepare the tools for installation, follow as: 12-14wrench, 17-19wrench.

STEP 3: Put the mount bracket B and the moun bracket C into the girder of the car, and tighten it M8"U" bolt L.

STEP 4: Install the grille guard A on the mount bracket B , with M12x25 bolt E and then tighten it.

STEP 5: Test and make sure that the grille guard is steadily fixed.

STEP 6: Installation is finished.