



# **INSTALLATION INSTRUCTIONS**

**PART # BB035709A3-SP-35OV**

**3-1/2" OVAL BULL BAR FOR**

**2007-15 CHEVY SILVERADO1500/GMC SIERRA1500**

**2007-15 TAHOE/SUBURBAN/YUKON/YUKON XL**

**2007-14 CADILLAC ESCALADE 1500/ESV/EXT**

**2007-13 CHEVY AVALANCHE**

**PARTS LIST:**

1	Bull Bar	6	12-1.75mm Nylon Lock Nut
1	Driver/Left Mounting Bracket	4	10-1.50mm x 30mm Hex Bolt
1	Passenger/Right Mounting Bracket	8	10mm x 27mm OD x 3mm Flat Washer
2	Light Brackets	4	10-1.50mm Nylon Lock Nut
2	12x1.75mm x 30mm Double Bolt Plate	4	6-1.0mm x 20mm Button Head Bolts
2	12 x 35mm Bolt Plate Single Bolt Plate	4	6mm Lock washers
6	12mm x 24mm OD x 2.5mm Flat Washer	4	6mm x 18mm OD x 1.6mm Flat Washers

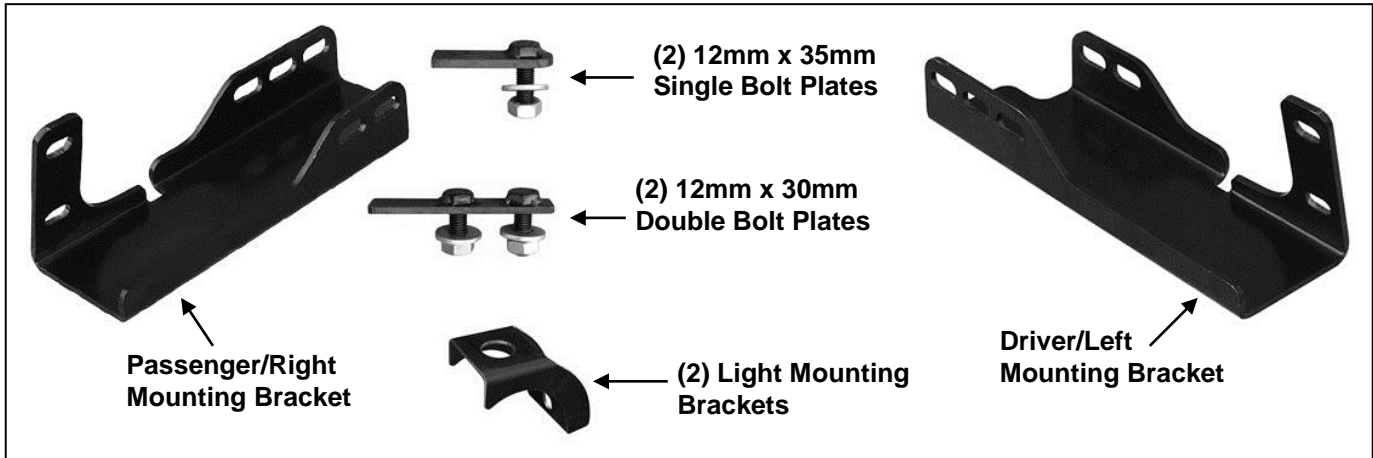

**PROCEDURE:**

**REMOVE CONTENTS FROM BOX AND VERIFY ALL PARTS ARE PRESENT. READ INSTRUCTIONS CAREFULLY. CUTTING MAY BE REQUIRED. INSTALLATION MAY INTERFERE WITH FRONT MOUNTED SENSORS. NOTE:** It may be necessary to remove/relocate front license plate and license plate bracket. It is not required, but strongly recommended. If local/state law requires a front license plate, license plate relocation kit is available.

1. Start installation from under the front of the vehicle. Determine if the vehicle is equipped with tow hooks. **IMPORTANT:** Tow hooks cannot be reinstalled with the Bull Bar.

**Tow Hook equipped vehicles:**

- a. Remove the factory tow hook from the end of each frame channel, **(Figure 1)**. Skip to **Step 2** if tow hooks were accessible and have been removed. **NOTE:** The driver side tow hook on some later models may be difficult to remove and assistance is highly recommended on these models. The following info only applies to the later GM models.
  - i. **Tow hook removal-option 1:** Remove the hex bolts securing the driver side of the bumper to the bracket. Use a short pry bar or large screwdriver to move the tab on the bumper bracket up and away to clear the hex bolt and slide it out past the bumper bracket, **(Figures 2A & 2B)**.
  - ii. **Option 2:** Remove plastic radiator grille. Loosen and/or completely remove the front bumper to remove the long hex bolt in the driver side tow hook, **(Figure 2B)**.
- b. Reattach the bumper after both tow hooks have been removed and the openings have been checked for Bracket clearance. Tighten all factory bumper hardware at this time.
- c. Proceed to **Step 2**.

**Vehicles without tow hooks:**

- a. Cut out the indented area in both sides of the plastic bumper insert to clear the Brackets as pictured, **(Figures 3 & 4)**. **IMPORTANT:** Make several small cuts for best fit. Do not cut through the top edge of the panel. **NOTE:** On some later models, the plastic panel is held in place with several small screws. The screws at the top corners are difficult to impossible to reach and remove without damaging the cover with the bumper in place. If you prefer to remove the panel to cut out



3-1/2" OVAL BULL BAR  
2007-15 CHEVY SILVERADO1500/GMC SIERRA1500  
2007-15 TAHOE/SUBURBAN/YUKON/YUKON XL  
2007-14 CADILLAC ESCALADE 1500/ESV/EXT  
2007-13 CHEVY AVALANCHE

### Driver Side Mounting Bracket Installation Pictured

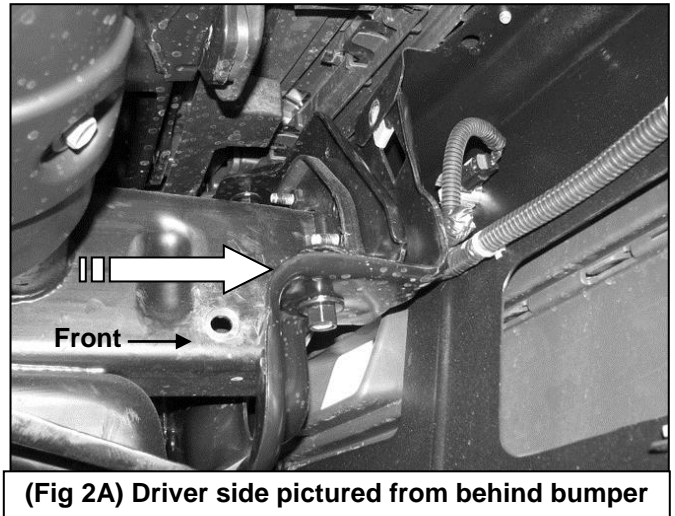
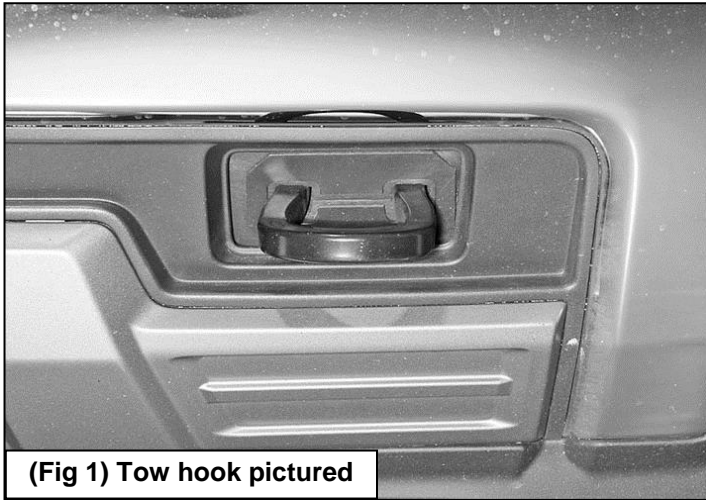

Remove the bolts securing the driver side of the bumper to the bumper bracket. Use a large screwdriver or pry bar to move the mounting tab up enough to get the long bolt through the tow hook out of the end of the frame

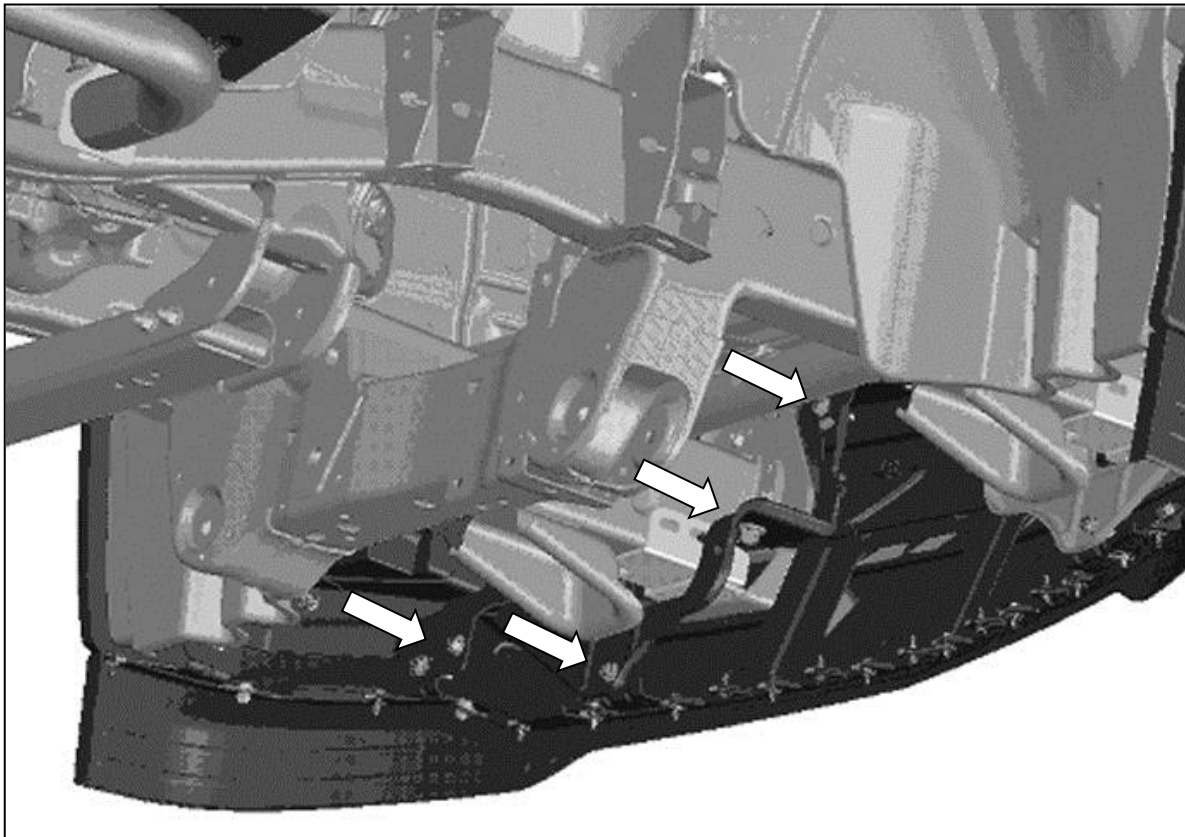

3-1/2" OVAL BULL BAR  
2007-15 CHEVY SILVERADO1500/GMC SIERRA1500  
2007-15 TAHOE/SUBURBAN/YUKON/YUKON XL  
2007-14 CADILLAC ESCALADE 1500/ESV/EXT  
2007-13 CHEVY AVALANCHE



(Fig 3) Example of "no tow hook" model

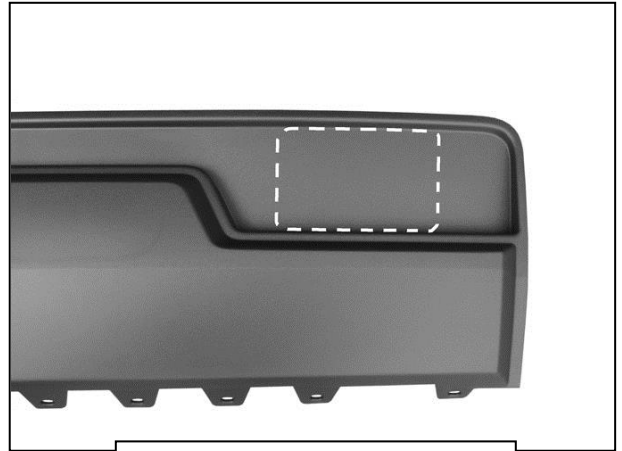

(Fig 4) Driver side cut out illustrated for reference only

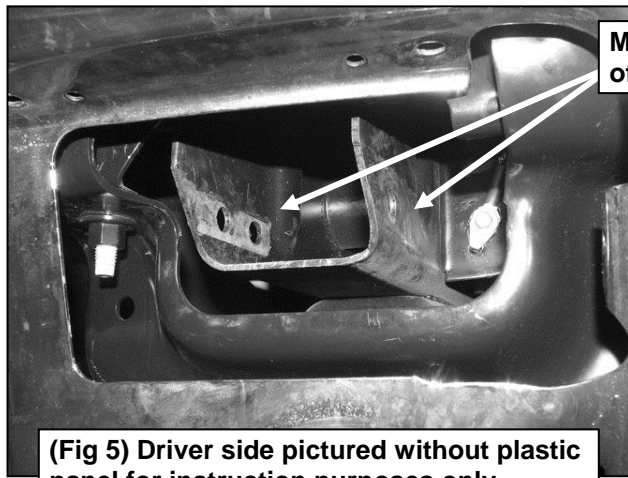

Mounting holes in end of frame for tow hook

(Fig 5) Driver side pictured without plastic panel for instruction purposes only

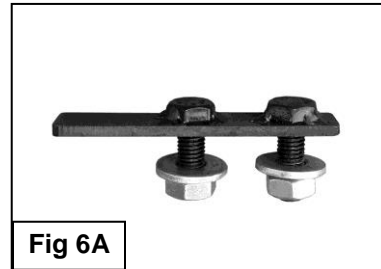
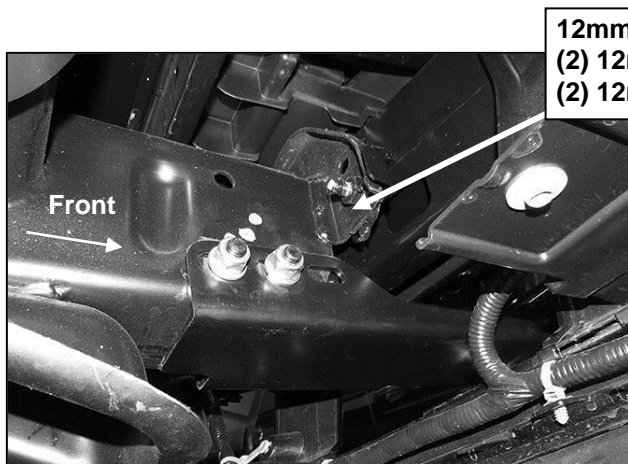
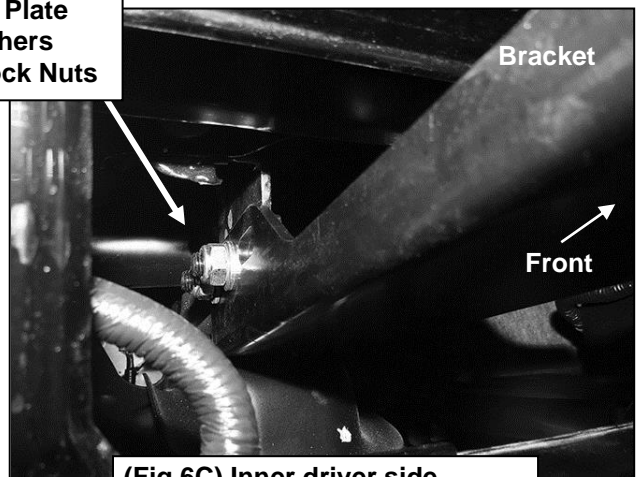

Fig 6A



12mm Double Bolt Plate  
(2) 12mm Flat Washers  
(2) 12mm Nylon Lock Nuts

(Fig 6B) Note Bracket installed in "forward" position to move Bull Bar away from bumper



(Fig 6C) Inner driver side Bracket with Double Bolt Plate

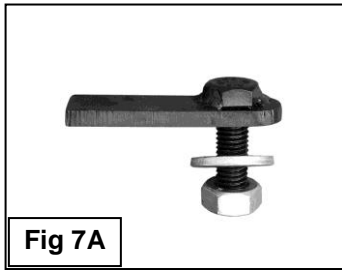

12mm Single Bolt Plate  
 12mm Flat Washer  
 12mm Nylon Lock Nut

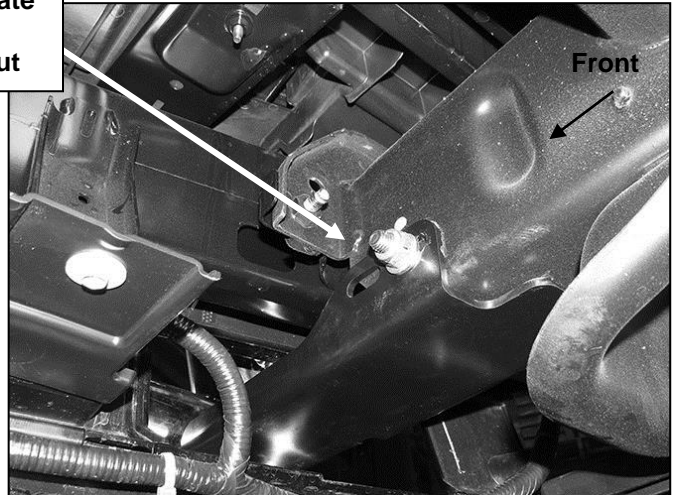

(Fig 7B) Passenger Bracket installed in "forward" position to move Bull Bar away from bumper

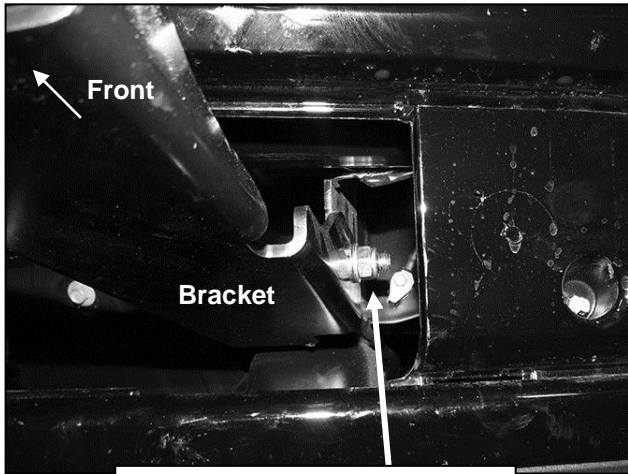

(Fig 7C) Outer driver side Bracket with Single Bolt Plate

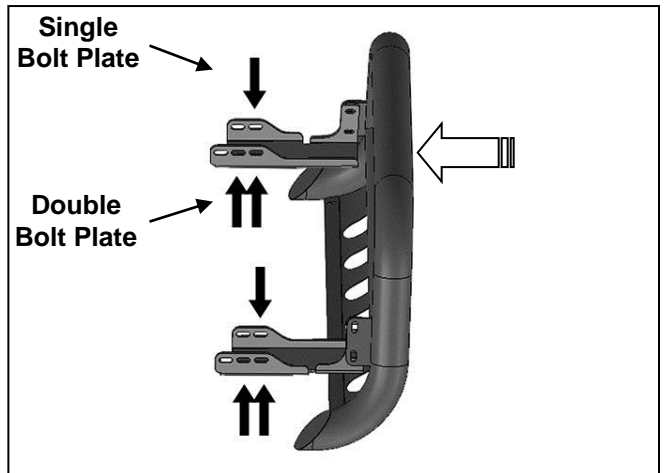

(Fig 8A) Typical Silverado/Sierra mounting position

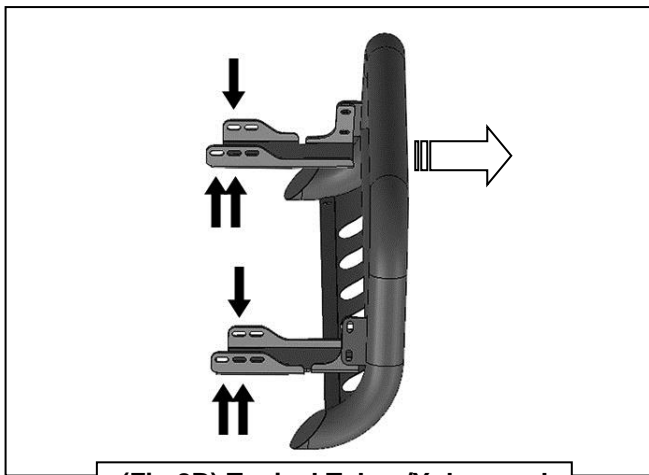

(Fig 8B) Typical Tahoe/Yukon and Suburban mounting position

3-1/2" OVAL BULL BAR  
2007-15 CHEVY SILVERADO1500/GMC SIERRA1500  
2007-15 TAHOE/SUBURBAN/YUKON/YUKON XL  
2007-14 CADILLAC ESCALADE 1500/ESV/EXT  
2007-13 CHEVY AVALANCHE

(2) 10mm x 30mm Hex Bolts  
(4) 10mm Flat Washers  
(2) 10mm Nylon Lock Nuts

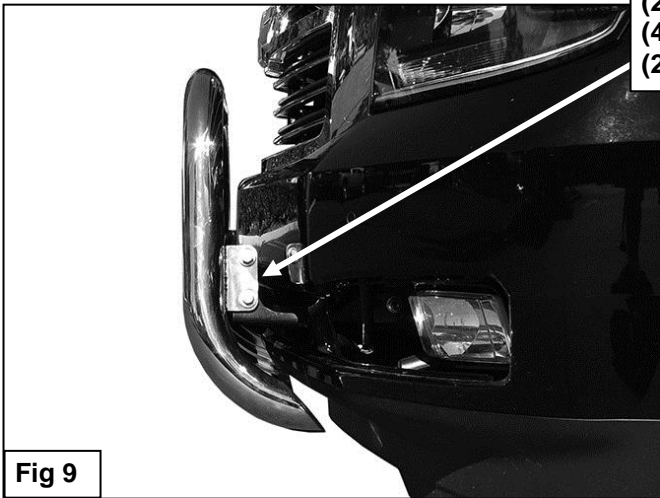

Fig 9

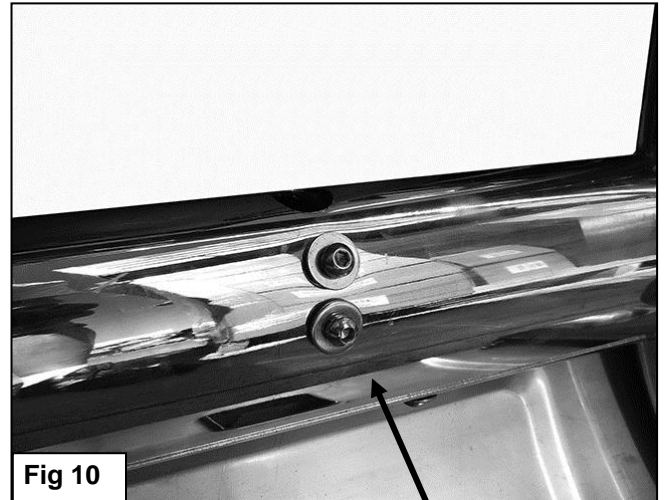

Fig 10

(2) 6mm x 20mm  
Button Head Bolts  
(2) 6mm Lock Washers  
(2) 6mm Flat Washers



(Fig 11) Light Mounting Bracket

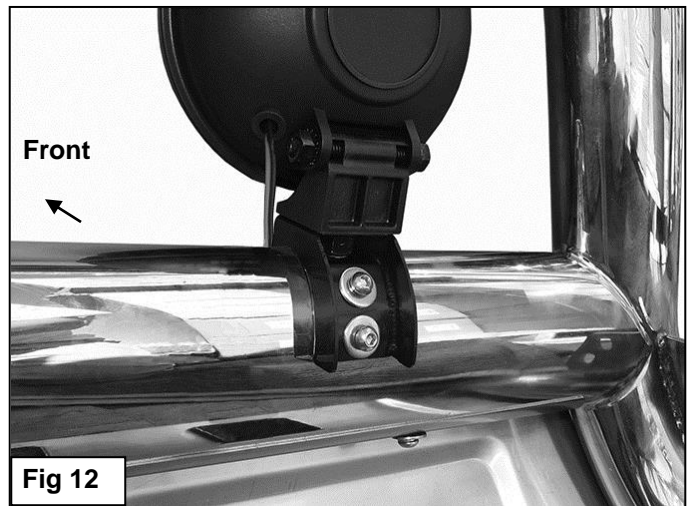

Fig 12

Light pictured for example only-  
light not included



Complete Installation