

# INSTALLATION INSTRUCTION




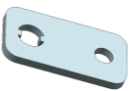







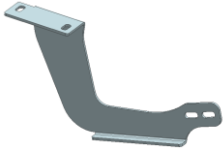


ITEM NUMBER: **8D118501SS-DL**

BRACKETS FOR S/S UNIVERSAL REAR BUMPER GUARD (DOUBLE LAYER) FOR NISSAN MURANO 09-15

## NOTICE:

- ≡ The figures here are for reference only and may have differences with the actual product you received, however they share the same assembly way.
- ≡ Please read the instruction completely for easy installation, which will also help you to avoid scratches or other potential damages to your appealing car.
- ≡ Please periodically check and retighten all the hardware and clean the investment for a refresh look.

## PART LIST

No.	Qty	Name	No.	Qty	Name
①	1	 Rear bar	6	2	 Hook bolt
②	1	 Bracket-A-L	7	2	 Hook bolt connection plate
			8	2	 Plastic plate
③	1	 Bracket-A-R	9	1	 Shim
			10	4	 M8*25 Hex bolt
④	1	 Bracket-B-L	11	4	 M10*35 Hex bolt
			12	10	 D10 Flat washer
⑤	1	 Bracket-B-R	13	6	 D10 Spring washer
			13	6	 D10 Hex nut

**ASSEMBLY PROCEDURE:**

Step 1: Check all the contents are available in accordance with the above list.

Step 2: Remove the factory hex bolts as **FIG.2**, using these factory bolts to install Bracket-B-L, don't forget to put the shim between the bracket and car frame. Do not tighten all the bolts.

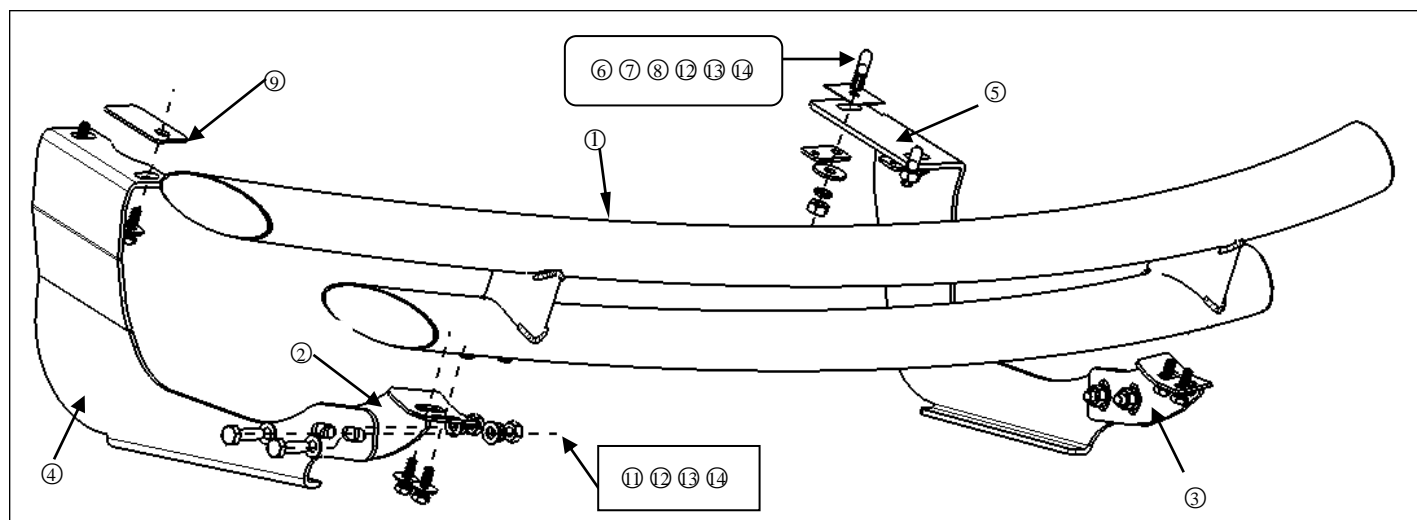
Step 3: Using hook bolt to install Bracket-B-R. Do not tighten all the bolts. (**FIG.3**)

Step 4: Install the rear bar on Bracket-A-L & B. Connect Bracket-A & B as **FIG.1**. Do not tighten all the bolts.

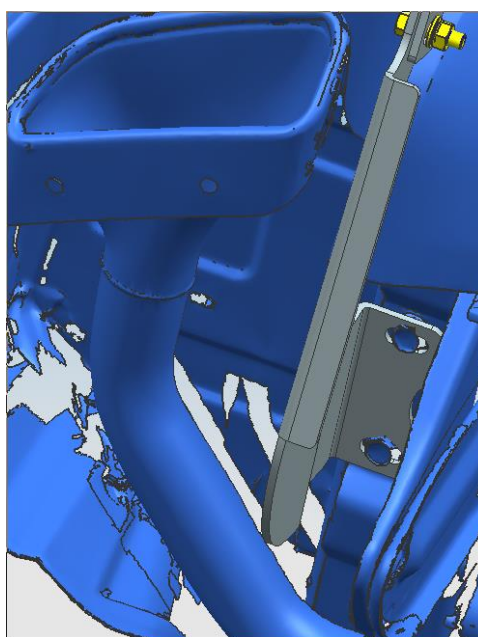
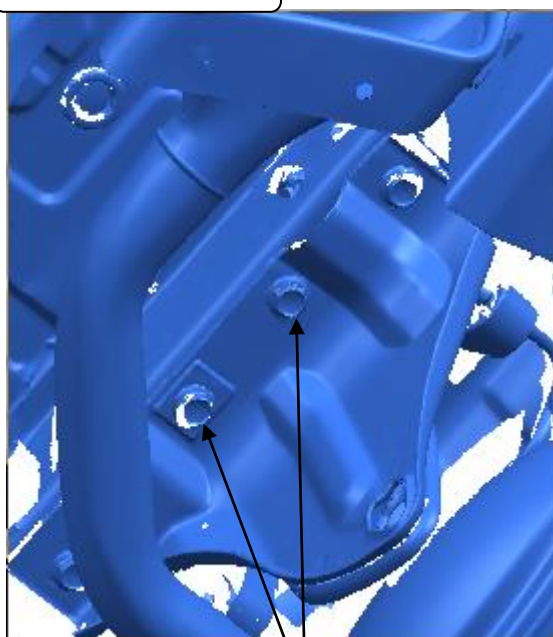
Step 5: Test and make sure that the rear bar is steadily fixed, and then tighten all the hardware.

Step 6: Installation is finished.

**FIG.1**

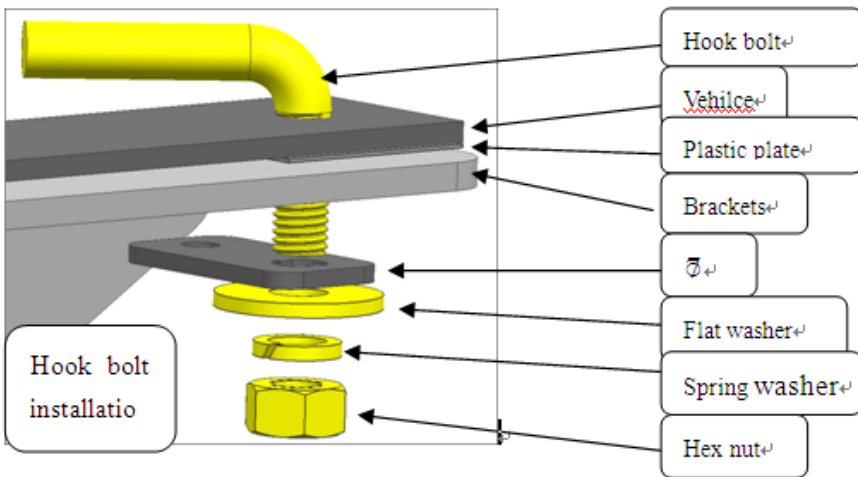
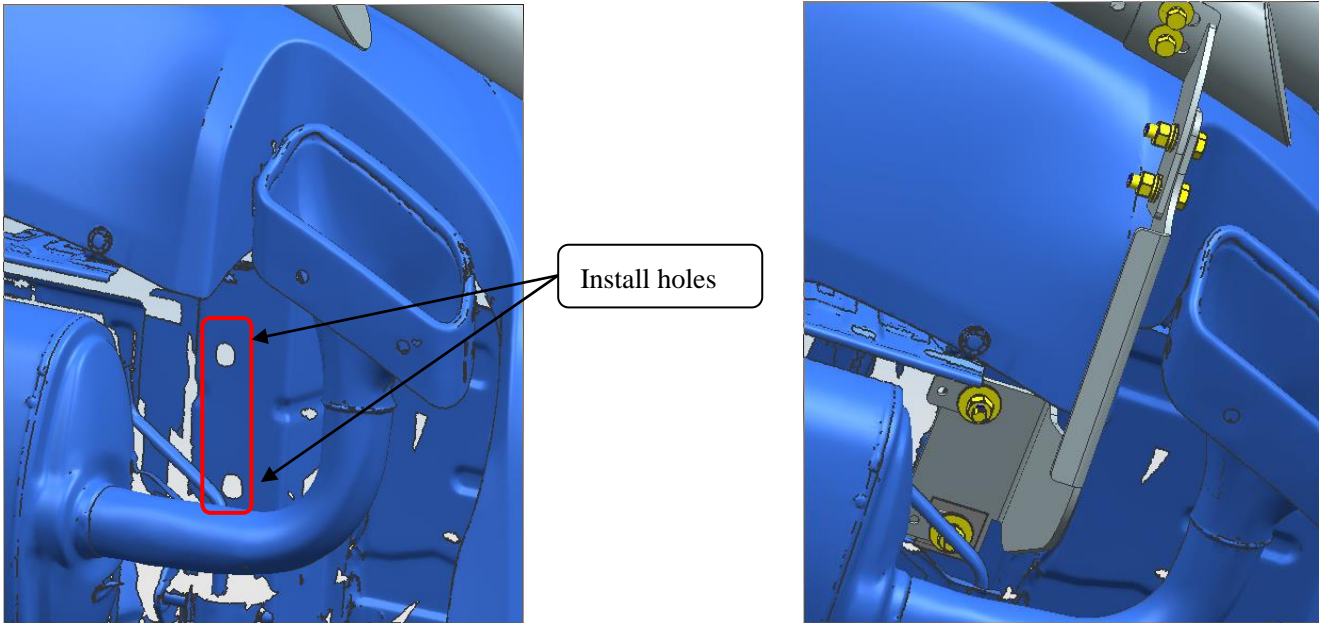


**FIG.2**



Remove the factory hex bolts

FIG.3



**NOTE:** Any damages and losses caused by improper installation and application, goes beyond our quality warranty.