

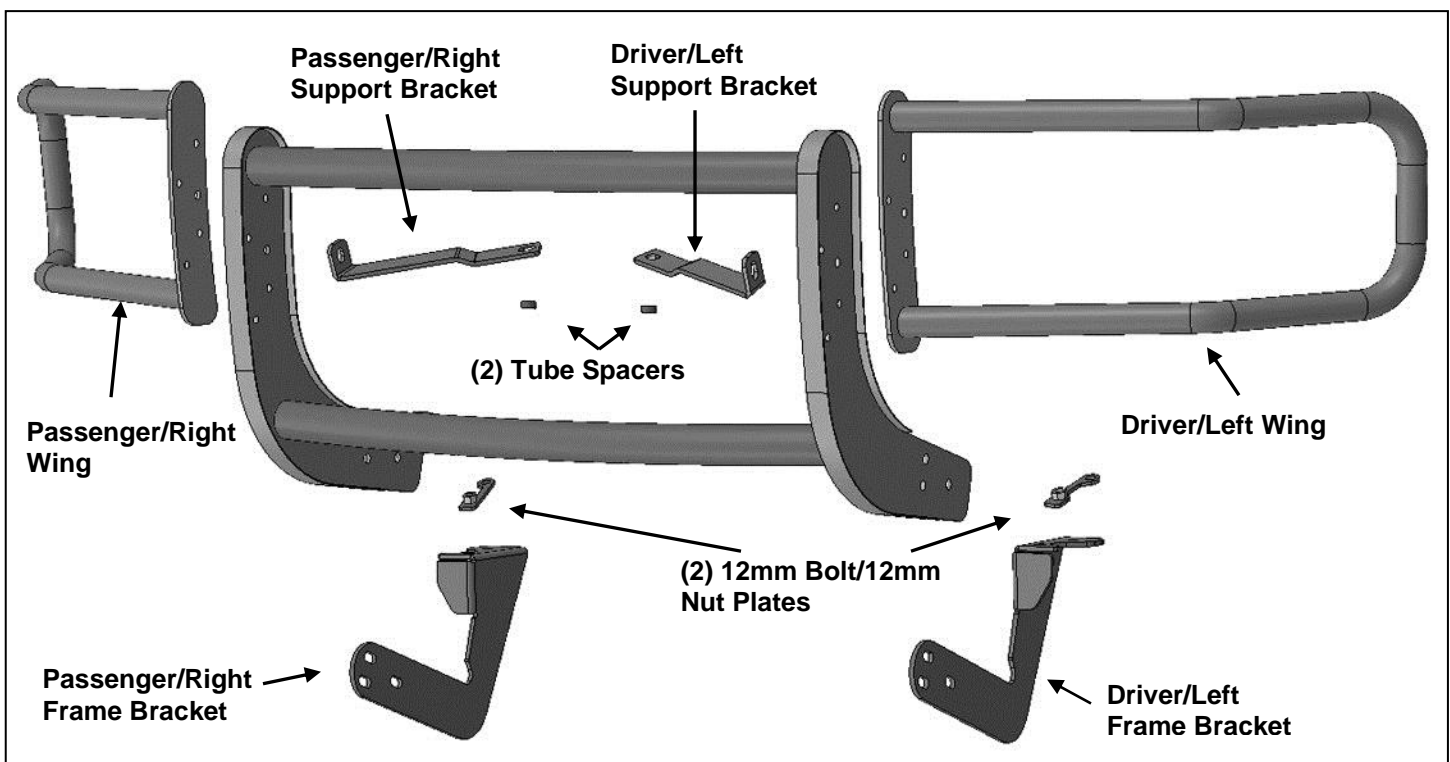

INSTALLATION INSTRUCTIONS
PART#: 17D501MA
SPARTAN GRILLE GUARD
07-15 DODGE/MERCEDES-BENZ SPRINTER (FULL SIZE)

PARTS LIST:

1	Front Runner Grill Guard Center Section	14	12mm x 32mm OD x 3mm Flat Washers
1	Driver/left Wing	8	12mm Lock Washers
1	Passenger/right Wing	8	12mm Hex Nuts
1	Driver/left Frame Mounting Bracket	2	10mm x 35mm Button Head Bolts
1	Passenger/right Frame Mounting Bracket	4	10mm x 24mm x 2mm Flat Washers
1	Driver/left Support Bracket	2	10mm Nylon Lock Nuts
1	Passenger/right Support Bracket	2	8-1.25mm x 40mm Hex Bolts
2	Tube Spacers	8	8-1.25mm x 25mm Hex Bolts
2	12-1.75mm x 35mm Bolt/12mm Nut Plates	18	8mm x 24mm x 2mm Flat Washer
6	12-1.75mm x 35mm Hex Bolts	2	8mm Lock Washers
		8	8mm Nylon Lock Nuts



PROCEDURE:

- 1. REMOVE CONTENTS FROM BOX. VERIFY ALL PARTS ARE PRESENT. READ INSTRUCTIONS CAREFULLY BEFORE STARTING INSTALLATION. DRILLING IS REQUIRED. ASSISTANCE IS RECOMMENDED.**
- Starting on the driver side of the vehicle, locate the factory hole in the bottom of the frame channel, **(Figure 1)**. Insert (1) 12mm Bolt and Nut Plate into the frame rail, **(Figures 1 & 2)**. **NOTE:** Insert Bolt Plate with welded Nut toward the front of the vehicle. The offset Bolt and Nut Plate is designed to clear hardware that may be attached to the inside of the frame, **(Figure 1)**. It is important to correctly orient the Bolt and Nut Plate in the frame channel.
- Attach the driver side Frame Bracket to the Bolt and Nut Plate with (1) 12mm Flat Washer, (1) 12mm Lock Washer and (1) 12mm Hex Nut, **(Figures 3 & 4)**. Do not tighten hardware at this time. Repeat this Step for passenger side Frame Bracket installation.
- With assistance, position the Grille Guard Center Section up to the outside of the Frame Mounting Brackets. Attach the Grille Guard to the Brackets with (6) 12mm x 35mm Hex Bolts,

- (12) 12mm Flat Washers, (61) 12mm Lock Washers and (6) 12mm Hex Nuts, **(Figures 5 & 6)**. Do not tighten hardware at this time.
5. Next, remove the (2) Torx bolts in the bottom of the opening in the front bumper step area, **(Figure 7)**. Place a Tube Spacer into the driver side recess in the bumper cover, **(Figures 8 & 9)**. Position the driver side Support Bracket over the Tube Spacer. Attach the Support Bracket to the Spacer and the bumper with the included 8mm x 40mm Hex Bolt, 8mm Lock Washer and 8mm Flat Washer to bolt the Bracket to the front bumper, **(Figure 10)**. Do not tighten hardware at this time.
 6. Attach the bent outer end of the Support Bracket to the inside of the Grille Guard with (1) 10mm x 25mm Button Head Bolt, (2) 10mm Flat Washers and (1) 10mm Nylon Lock Nut, **(Figure 10)**. Do not tighten hardware at this time.
 7. Repeat **Steps 5 & 6** to install the passenger side Support Bracket.
 8. Next, select the driver side Bumper Guard Wing. Attach the Wing to the outside of the Center Section with the included (4) 8mm x 25mm Hex Bolts, (8) 8mm Flat Washers and (4) 8mm Nylon Lock Nuts, **(Figure 11)**. Fully tighten the Wing hardware only at this time. Repeat this Step to install the passenger side Wing. **NOTE:** Wing installation is optional.
 9. Align Grille Guard properly and tighten all hardware at this time.
 10. Once you have the Grille Guard completely installed and properly aligned, use the second hole, (unused till now), in each Frame Bracket as a template to mark the drilling location on the bottom of both frame channels, **(Figure 12)**. **Do not** mark the frame until after the Grille Guard has been completely installed and properly aligned and adjusted. No adjustments can be made after the frame is drilled.
 11. Remove the Grille Guard, Frame Brackets and 12mm Bolt and Nut Plates from the vehicle. **NOTE:** It is not necessary to remove the Support Brackets from the vehicle, only loosen and move out of the way to remove Center Section.
 12. Use a 1/2" drill bit to drill out the marked location, **(Figure 13)**. **IMPORTANT:** Any cutting or drilling tool may break or shatter. Government regulations require safety glasses & equipment at all times when cutting or drilling.
 13. Reinsert the driver side Bolt and Nut Plate, **(Step 2)**. Rotate the 12mm Bolt and Nut Plate to line up the threaded nut with the previously drilled 1/2" hole. Reattach the Bracket to the Bolt Plate as described in Step 3. Use the included 12mm x 35mm Hex Bolt, 12mm Lock Washer and 12mm Flat Washer to attach the remaining hole in the Bracket, (and drilled hole in frame), to the 12mm Bolt and Nut Plate, **(Figure 14)**.
 14. Repeat **Steps 12 & 13** to drill and reattach the passenger side Frame Bracket.
 15. Re-install the Grille Guard as previously described in **Steps 4—9**. Align Grille Guard before tightening all hardware.
 16. Do periodic inspections to the installation to make sure that all hardware is secure and tight.

To protect your investment, wax this product after installing. Regular waxing is recommended to add a protective layer over the finish. Do not use any type of polish or wax that may contain abrasives that could damage the finish.

For stainless steel: Aluminum polish may be used to polish small scratches and scuffs on the finish. Mild soap may be used also to clean the Grille Guard.

For gloss black finishes: Mild soap may be used to clean the Grille Guard.

Driver Side Installation Pictured

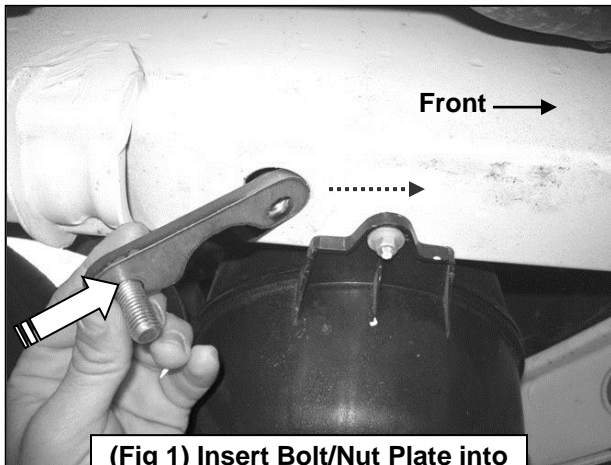

(Fig 1) Insert Bolt/Nut Plate into factory hole in bottom of frame

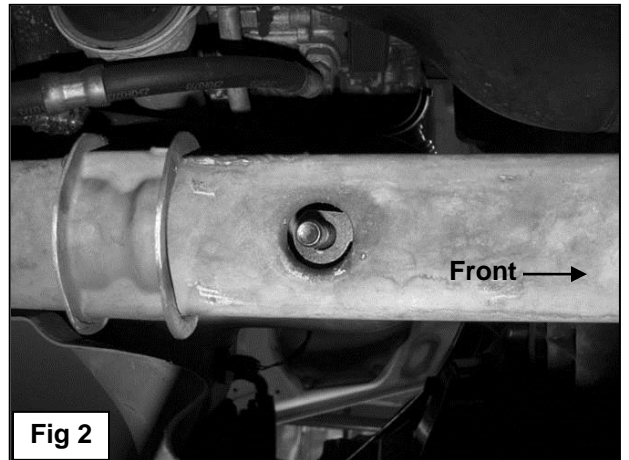

Fig 2

12mm Flat Washer
12mm Lock Washer
12mm Hex Nut



(Fig 3) Slide Bracket over Bolt Plate

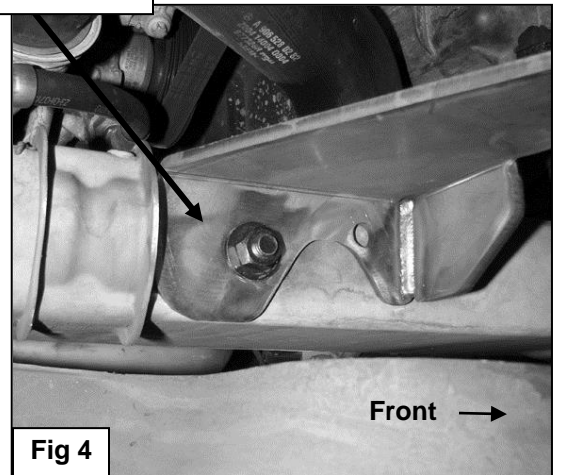

Fig 4

(3) 12mm x 35mm Hex Bolts
(6) 12mm Flat Washers
(3) 12mm Lock Washers
(3) 12mm Hex Nuts

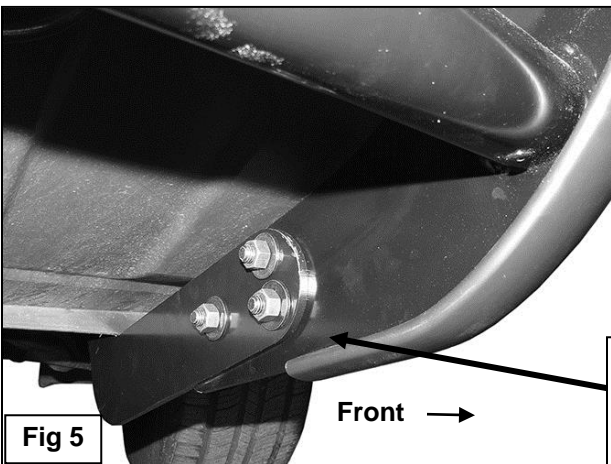
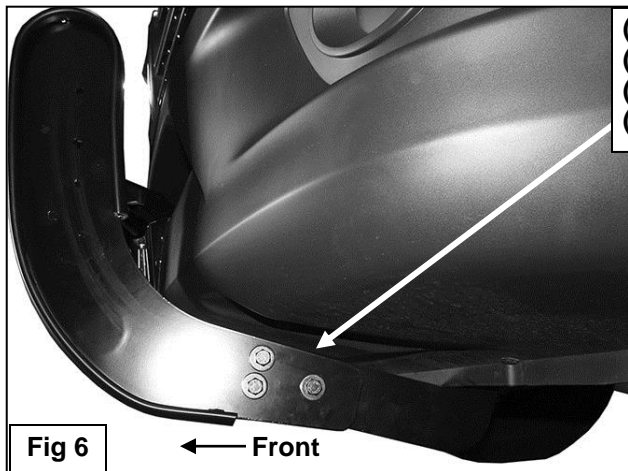
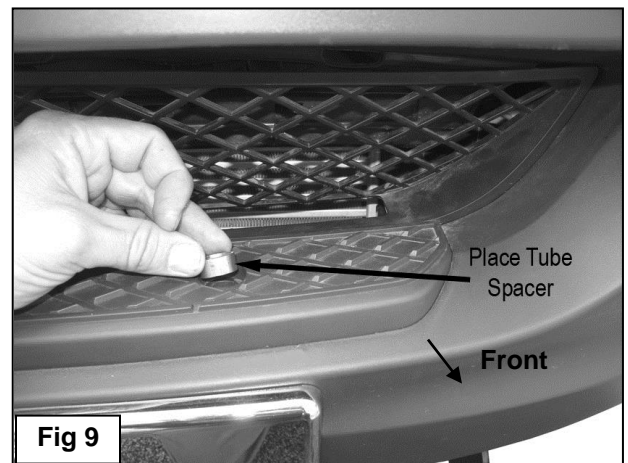
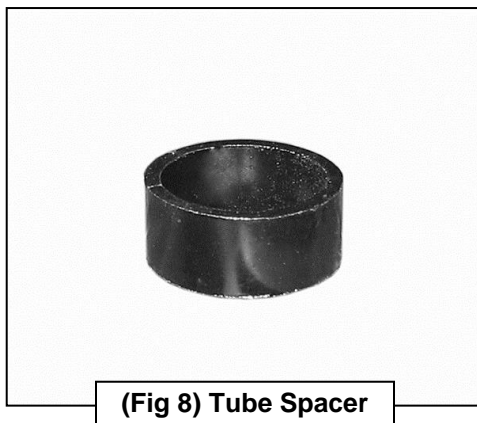
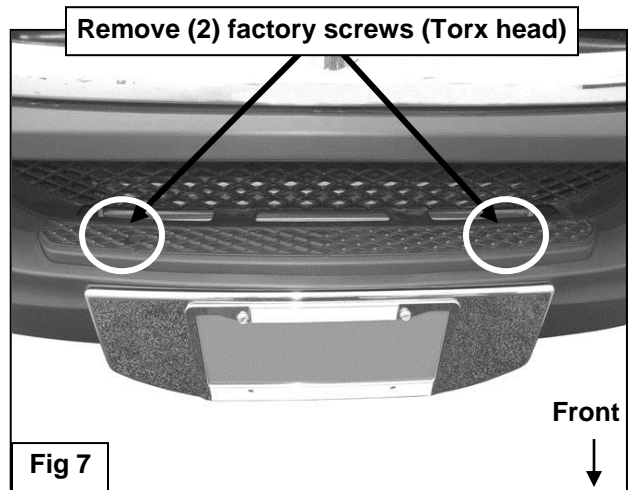

Fig 5

Driver Side Installation Pictured



- (3) 12mm x 35mm Hex Bolts
- (6) 12mm Flat Washers
- (3) 12mm Lock Washers
- (3) 12mm Hex Nuts



- 8mm x 40mm Hex Bolt
- 8mm Lock Washer
- 8mm Flat Washer

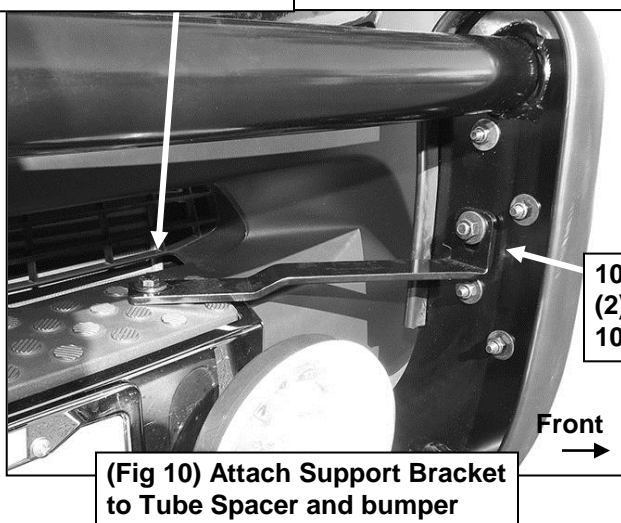

- 10mm x 35mm Button Head Bolt
- (2) 10mm Flat Washers
- 10mm Nylon Lock Nut

Driver Side Installation Pictured

- (4) 8mm x 25mm Hex Bolts
- (8) 8mm Flat Washers
- (4) 8mm Nylon Lock Nuts

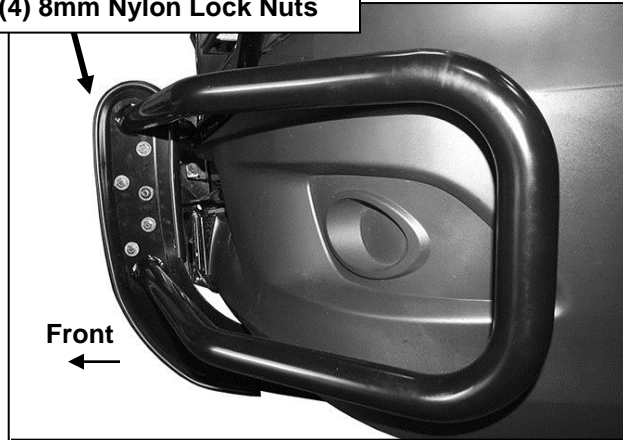

Mark hole location onto bottom of frame channel. Remove Grille Guard and Frame Brackets

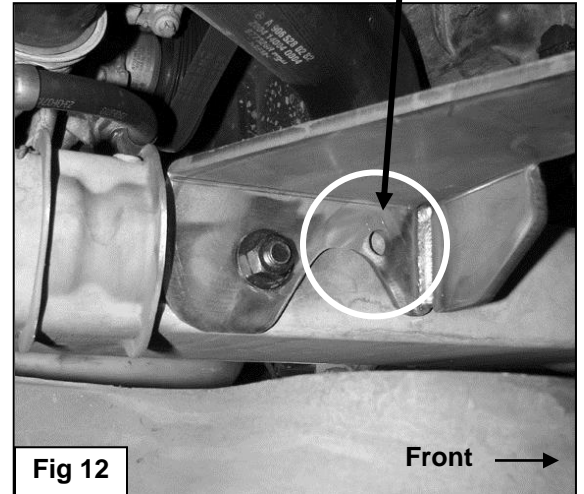

(Fig 11) Bolt Wing to Center Section (optional)

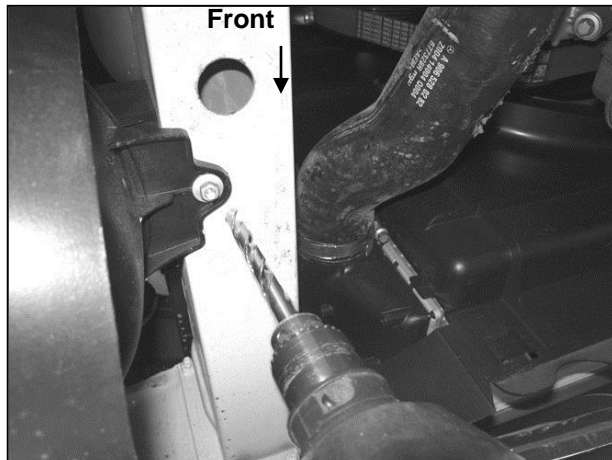

(Fig 13) Drill 1/2" hole in bottom of frame channel

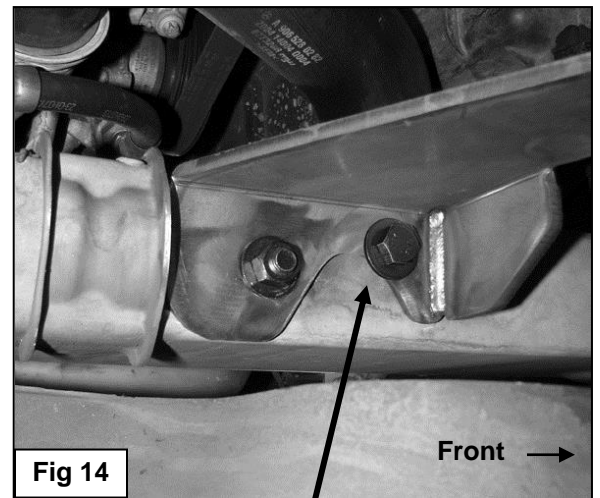

- 12mm x 35mm Hex Bolt
- 12mm Lock Washer
- 12mm Flat Washer



Complete Installation (note aftermarket lights not included)