



INSTALLATION INSTRUCTIONS

PART # BBTY916SS/BBTY916A

CITY BAR FOR TOYOTA SIENNA 09-11

PARTS LIST:

1	City Bar	10	12mm x 32mm OD x 3mm Flat Washers
1	Top Bracket	6	12mm Lock Washers
1	Driver/Left Frame Mounting Bracket	4	12mm Hex Nuts
1	Passenger/Right Frame Mounting Bracket	2	10-1.25mm x 40mm Fine Thread Hex Bolts
1	Driver/Left Mounting Bracket	2	10mm x 27mm OD x 3mm Flat Washers
1	Passenger/Right Mounting Bracket	2	10mm Lock Washers
2	25mm OD x 11.5mm Tall Tube Spacers	1	6-1.0mm x 20mm Button Head Allen Bolt (Top Bracket)
4	12-1.75mm x 35mm Hex Bolts	1	6mm Lock Washer (Top Bracket)
2	12-1.75mm x 40mm Hex Bolts	1	6mm x 12mm OD x 1.6mm Flat Washer (Top Bracket)

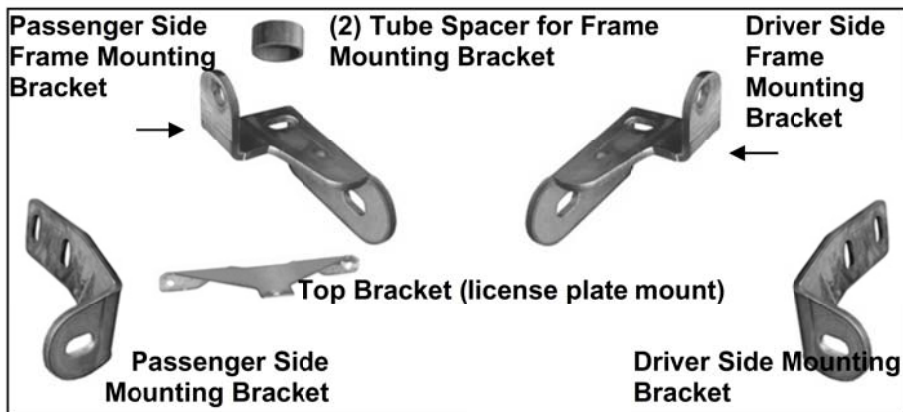

PROCEDURE:

1. REMOVE CONTENTS FROM BOX. VERIFY ALL PARTS ARE PRESENT. READ INSTRUCTIONS CAREFULLY BEFORE STARTING INSTALLATION. CUTTING OF THE SPLASH GUARD IS REQUIRED. ASSISTANCE IS RECOMMENDED.
2. Remove the plastic splash guard from under the front bumper and place it on a clean, stable work surface. **IMPORTANT:** Pay close attention to the specific location of all of the plastic clips and screws to make reinstallation easier. Use a small flat blade screwdriver to gently pry up the center pin to release the plastic clips. Remove the center pin and plastic housing.
3. Starting at the driver side, remove the (2) factory hex bolts securing the frame support to the crossmember. **NOTE:** Only install one Frame Mounting Bracket at a time and only remove the (2) factory hex bolts required to install the Bracket, **(Figure 1A)**. Select the driver side Frame Mounting Bracket and hold it up into position. Start installation by inserting (1) factory hex bolt into the top hole in the Frame Mounting Bracket. Do not tighten this bolt. Next, insert (1) Tube Spacer between the Frame Mounting Bracket and the crossmember, **(Figure 1B)**. Replace the factory bolt on the bottom with the supplied 10-1.25mm x 40mm Fine Thread Hex Bolt, 10mm Flat Washer and 10mm Lock Washer and thread it through the Frame Mounting Bracket, Tube Spacer and into the crossmember. **NOTE:** Once all hardware is started but loose, tighten the top bolt first before tightening remaining hardware.
4. Select the driver side Mounting Bracket. Bolt the Mounting Bracket to the outside of the Frame Mounting Bracket with the included (2) 12mm x 35mm Hex Bolts, (2) 12mm Lock Washers, (4)

12mm Flat Washers and (2) 12mm Hex Nuts, (**Figure 2**). Snug but do not tighten hardware at this time. Repeat Steps 3 & 4 for the passenger side bracket installation.

5. Place the City Bar face down on a clean surface in front of the vehicle. **NOTE:** Use the packing materials to protect the finish on the City Bar. With assistance, carefully position the City Bar up to the Mounting Brackets. Attach the City Bar to the Mounting Brackets using the included (2) 12mm x 40mm Hex Bolts, (2) 12mm Lock Washers, (2) 12mm Flat Washers, (**Figure 3**). Snug but do not tighten hardware at this time.
6. Next, select the Top Bracket and attach it to the (2) top license plate bracket bolts. **IMPORTANT:** Do not over tighten the (2) factory screws for the license plate or damage to the bumper cover may occur. Secure the Top Bracket to the City Bar with the provided (1) 6mm x 20mm Button Head Allen Bolt, (1) 6m Lock Washer and (1) 6mm Flat Washer, (**Figure 4**).
7. Level and adjust the City Bar and tighten all hardware.
8. Remove the City Bar (leave all mounting brackets in place). Hold the plastic splash guard up into position and mark the location to cut the splash guard to clear the Mounting Brackets, (**Figure 5A, 5B, 5C**). **IMPORTANT:** To maintain strength, cut only the material that is necessary to clear the Mounting Brackets. Once cut and trimmed for fit, reinstall the splash guard using the factory hardware.
9. Reinstall the City Bar and tighten all hardware.
10. Do periodic inspections to the installation to make sure that all hardware is secure and tight.

To protect your investment, wax this product after installing. Regular waxing is recommended to add a protective layer over the finish. Do not use any type of polish or wax that may contain abrasives that could damage the finish.

For stainless steel: Aluminum polish may be used to polish small scratches and scuffs on the finish. Mild soap may be used also to clean the City Bar.

For gloss black finishes: Mild soap may be used to clean the City Bar.

Driver Side Installation Pictured

Use the Factory Bolt

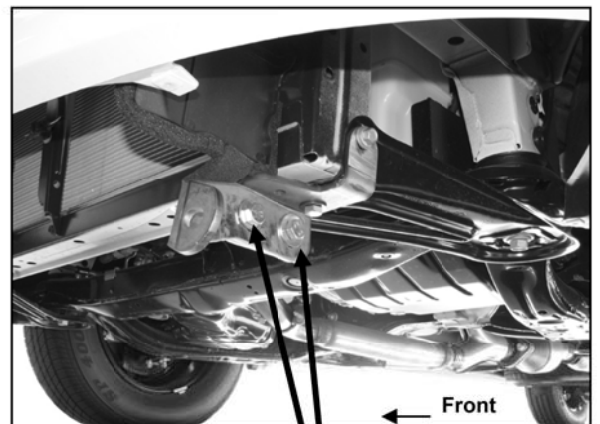
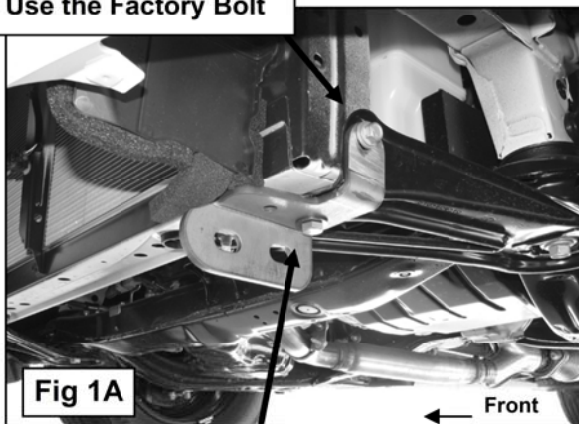

(1) 10-1.25mm x 40mm
Fine Thread Hex Bolt
(1) Tube Spacer
(1) 10mm Lock Washer
(1) 10mm Flat Washer

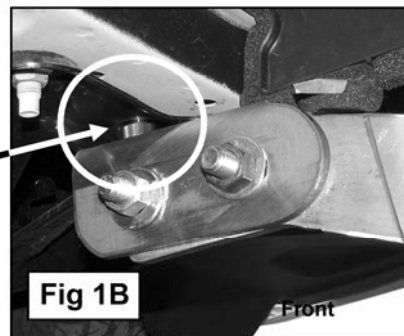

(2) 12mm x 35mm Hex Bolts
(2) 12mm Lock Washers
(4) 12mm Flat Washers
(2) 12mm Hex Nuts



Driver Side Installation Pictured

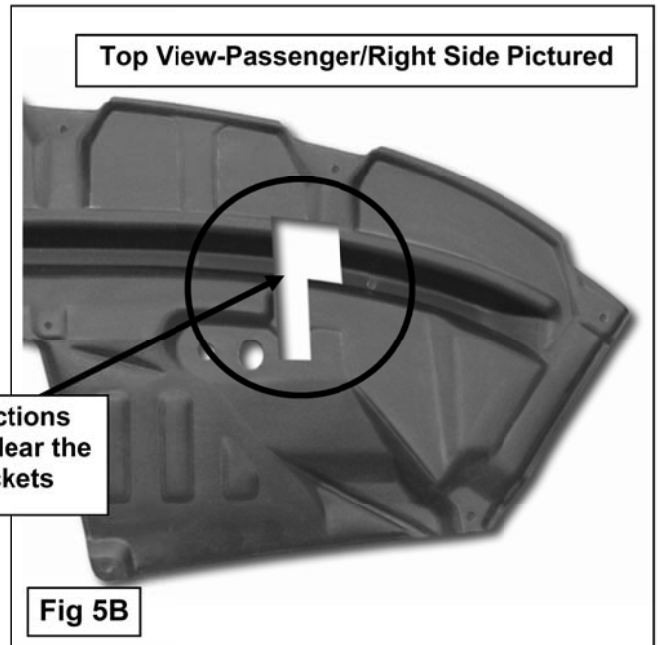
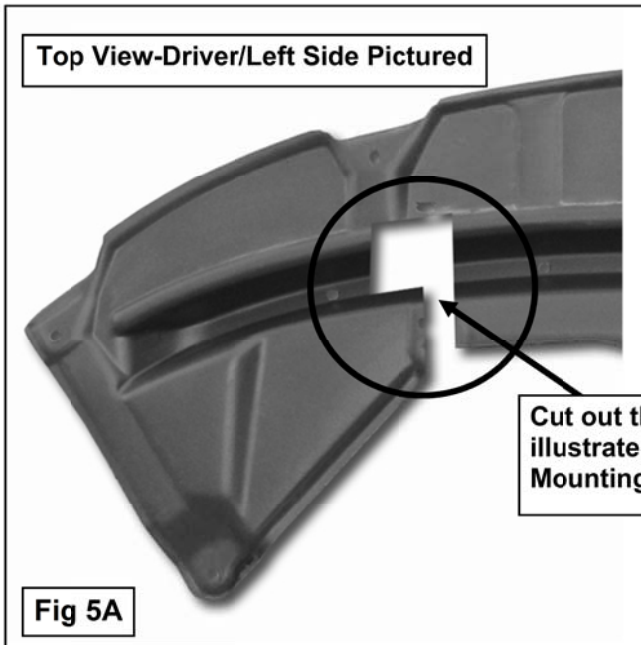
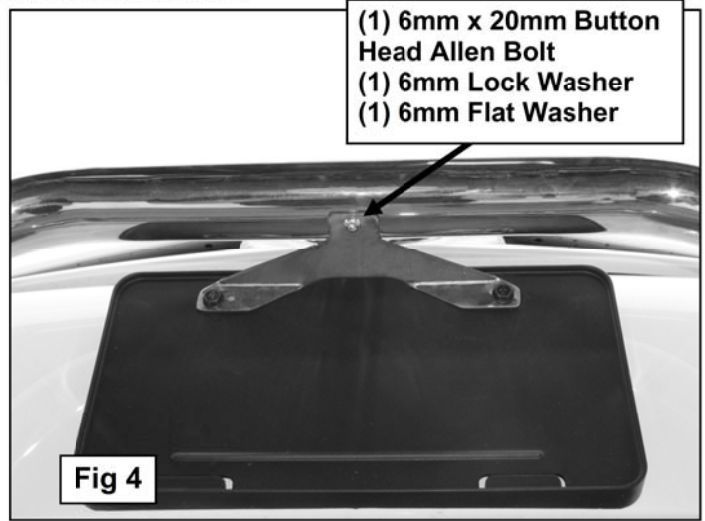
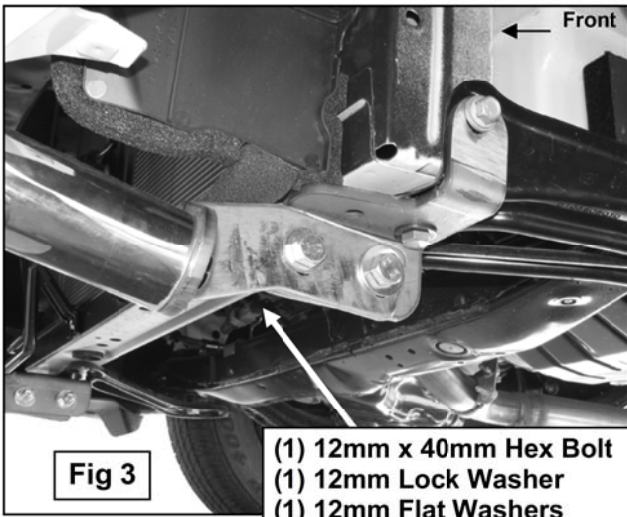

Cut out the sections illustrated to clear the Mounting Brackets

Frequently check for clearance during cutting. Only remove material required to clear the Mounting Brackets

