

E4-WM5-Y268A00

MOUNTING INSTRUCTION



Removal:

Place vehicle on a chassis hoist, lift it and remove wheels.



The lower control arm must be supported by suitable means!

Release bottom steering arm/ ABS line/ stabilizer/ brake hose and headlight range adjustment sensor (Xenon).

Remove bottom mount and top fixing nut from support bearing. Do not remove center nut at this time!

Remove complete strut and clamp it in an appropriate strut vise.

Measurement between top of original spring plate down to center of bottom mount must be recorded before removal carefully (see fig. **A**).

Using a suitable spring compressor, compress suspension spring until tension on support bearing is released.

Release center nut and remove original mounting parts and coil spring. Please refer to diagram to identify which parts will be replaced with BILSTEIN- supplied components.

Fitting:

Assemble BILSTEIN and/ or original mounting parts, as well as the new BILSTEIN spring on the BILSTEIN strut in reverse sequence of removal.

BILSTEIN shock absorber **B6** must be adjusted acc. the measurement between top of original spring plate down to center of bottom mount that was recorded before.

If a BILSTEIN Tuning kit **B12 for S211 station wagon** is been fitted the measurement from certificate (see fig. **B**) must be observed strictly.



Before releasing the spring, care is to be taken to ensure that the ends of the spring rest in the cutouts of the top and bottom spring plates.

The correct mounting position of [the suspension](#) springs can be determined by the printing on the springs; install them with the print upright.

Fit assembled shock absorber spring assembly to the vehicle in reverse sequence of removal.

All rubber- mounted strut/ damper attachments must not be fully tightened until AFTER the suspension system is loaded (wheels on the ground). Other mounting fasteners (for example brackets) must be securely tightened BEFORE load is placed on the suspension system.

All self- locking nuts must be replaced.
Tightening torques see list.

E4-WM5-Y268A00
MOUNTING INSTRUCTION



ALL DIAGRAMS ARE GENERALIZED
AND NOT TO SCALE!
BRACKETS, ETC. SPECIFIC TO
STRUT ARE NOT SHOWN!

Abb. A/ fig. A
B6



Abb. B/ fig. B
B12 S211 Kombi/
station wagon



E4-WM5-Y268A00 MOUNTING INSTRUCTION

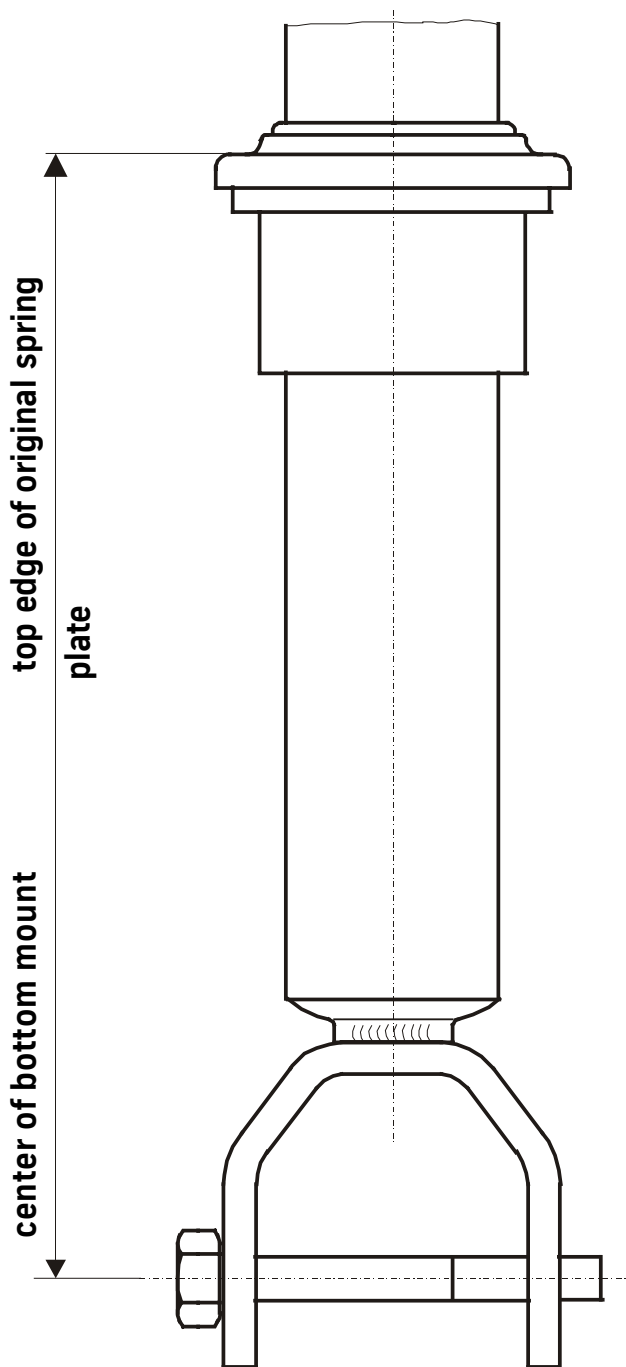
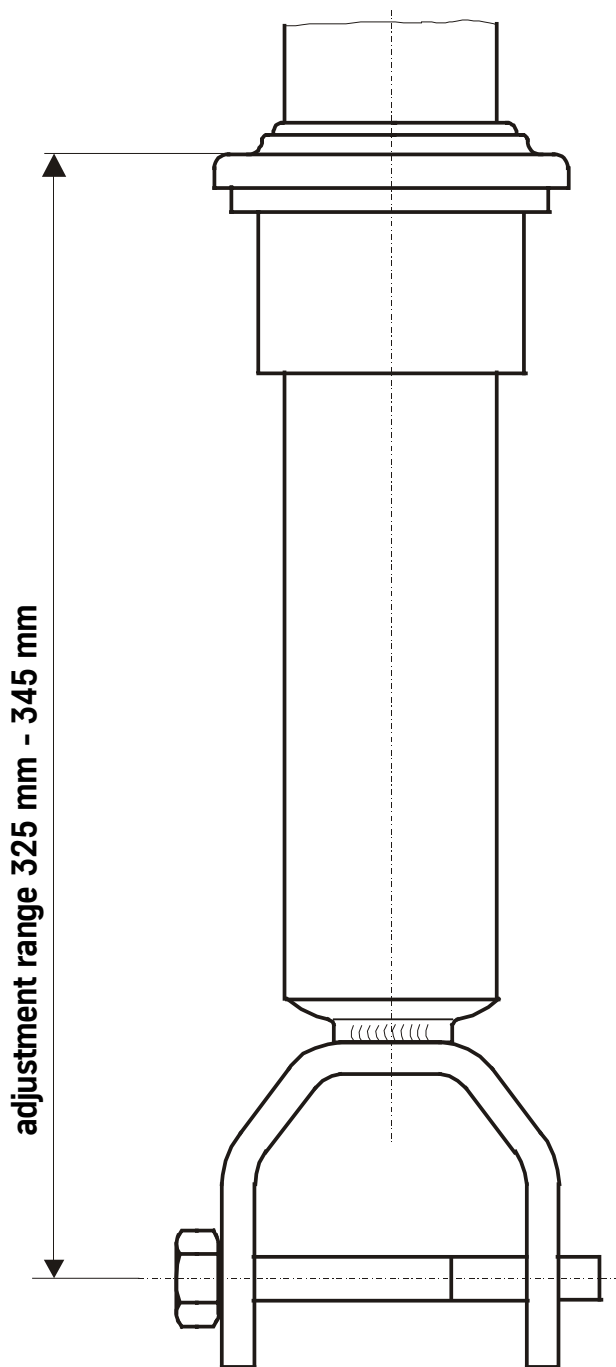

ALL DIAGRAMS ARE GENERALIZED
AND NOT TO SCALE!
BRACKETS, ETC. SPECIFIC TO
STRUT ARE NOT SHOWN!

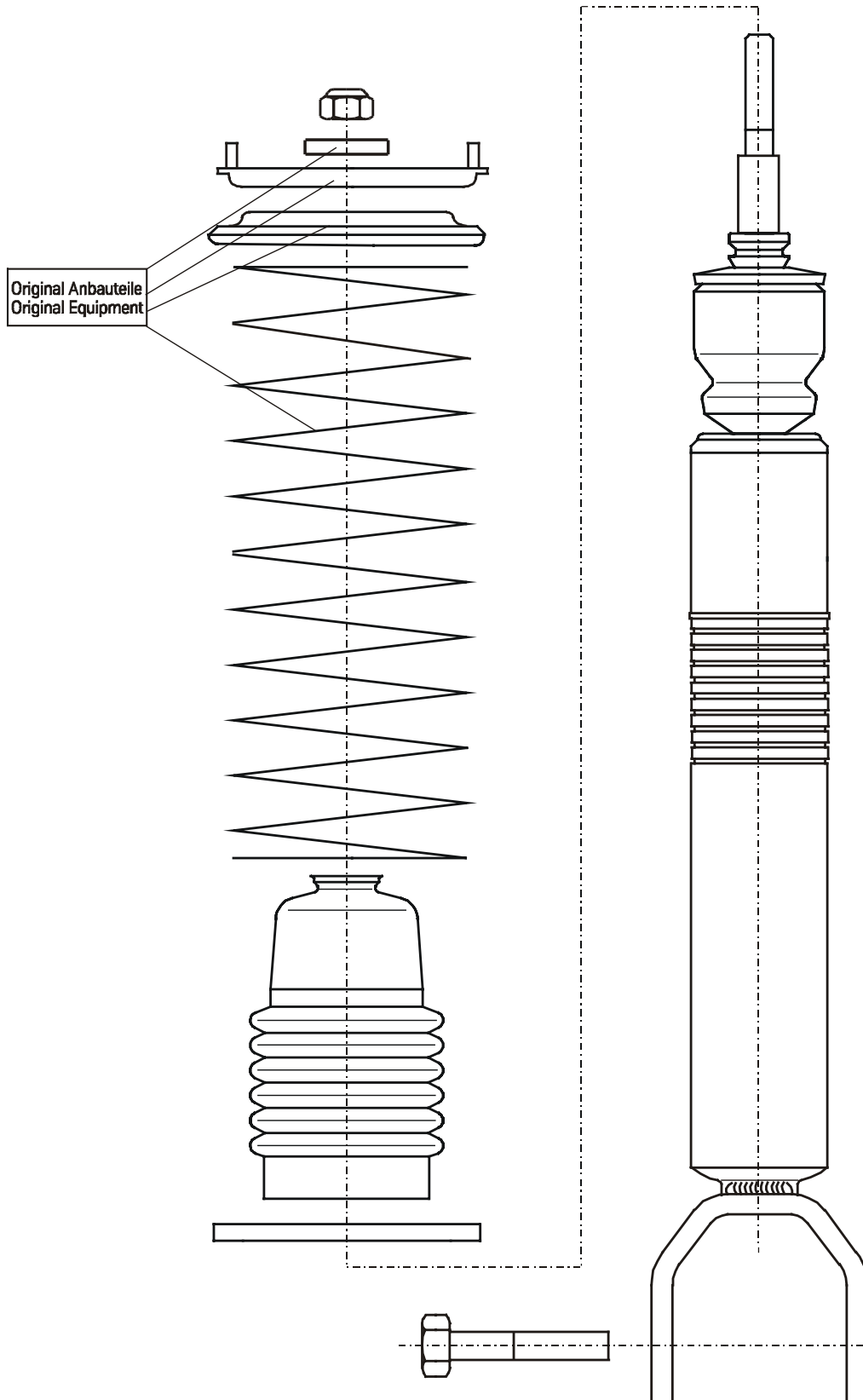

E4-WM5-Y268A00

MOUNTING INSTRUCTION



Fitting of plates with chamfer (if exist)

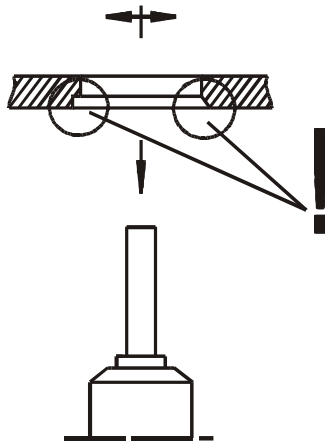

When fitting the spring plate (1) care must be taken to ensure that the circlip ring (2) is seated correctly!

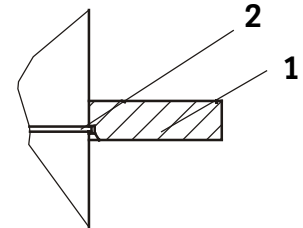

	M 8	M 10	M 12	M 14	M 16
	13	25	45	72	110
	10	19	34	54	83

List

Thread

Torque
Nm

Torque
ft lb

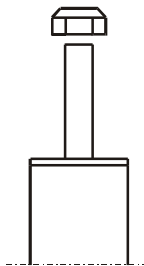
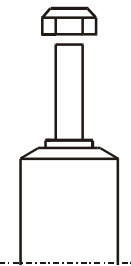

DO NOT USE IMPACT TOOLS FOR LOOSENING OR TIGHTENING FASTENERS, BECAUSE THIS MAY DESTROY THE THREADS. SELF- LOCKING NUTS MUST ONLY BE **USED ONCE!**