





# Installation Instructions EZ-Fold Tonneau

No Drilling in Truck Bed Required

## Vehicle Application:

- Fits most Makes and Models
- Part Number: 16999

INSTALLATION TIME	SKILL LEVEL
 Less than 15 minutes	 1 - Easy



TOOLS
 Safety Glasses

## Installation Tips

Before you begin installing this assembly, read all instructions thoroughly.

Check and secure all clamps to bed frame as indicated in the installation instructions before operating your vehicle.

Tonneau cover clamps must be securely attached prior to vehicle operation.

Secure retaining straps when cover is in open position.



## CAUTION

Safety glasses should be worn at all times while installing this product.



## WARNING

The buckle of each retaining strap and both clamps must be fastened securely to avoid damage to personal property or possible personal injury.

If the vehicle has an Over-the-Rail Bedliner, use a certified installer to perform the initial installation. Modifications to the Bedliner may be required.

# EZ-Fold Tonneau Installation Instructions

## Parts List

Bow Mount, Part Number 728600, Qty - 8

Tonneau Cover, Qty - 1

Corner, Part Number 475.36, Qty - 2

Left Clamp, Part Number 728620, Qty - 2

#10 x 5/8" Truss Head Screw, Part Number 728670, Qty - 16

Large Hinge, Part Number 473.58, Qty - 2

Small Hinge, Part Number 473.59, Qty - 2

Tie Down Strap, Part Number 470.95, Qty - 2

Right Clamp, Part Number 728625, Qty - 2

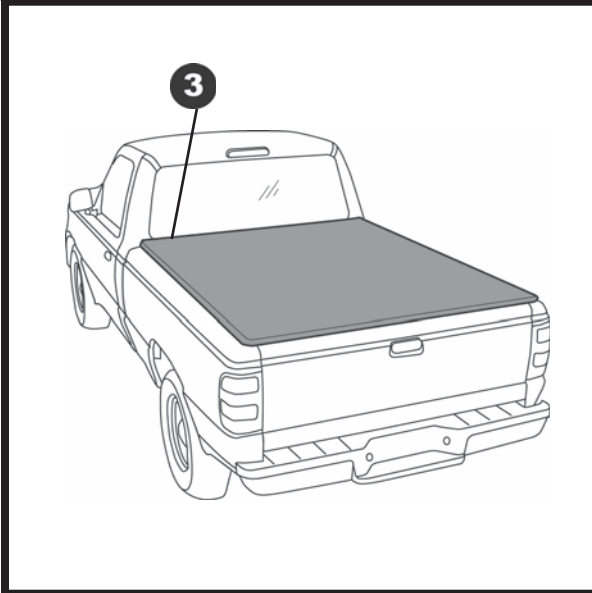

## 2 Place Tonneau on Bed

Place the Tonneau on the vehicle with the retaining straps facing up. Align the outside edge of the front rail with the outside edge of the bed. Center the Tonneau from side to side.

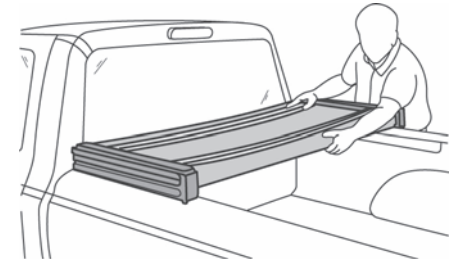

## 1 Remove EZ-Fold Tonneau from Box

Take fully assembled EZ-Fold Tonneau out of box and unfold.

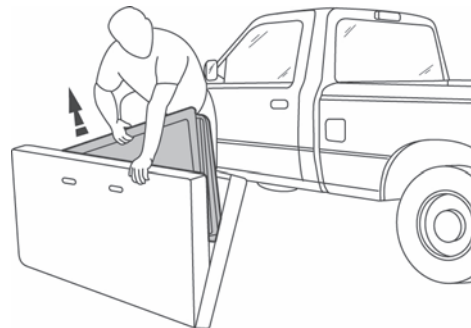

## 3 Release Front Clamp

On the driver's side, reach under the Tonneau and rotate the front clamp down from the storage position. Push the top saddle part of the clamp down and adjust the clamp by rotating it clockwise to loosen or counter-clockwise to tighten.

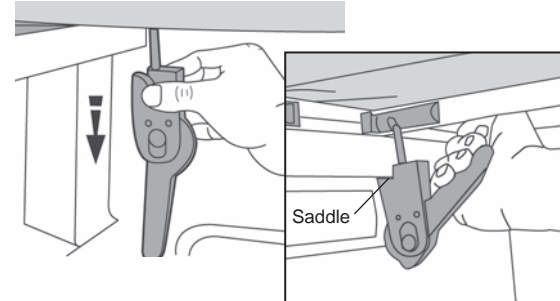

## EZ-Fold Tonneau Installation Instructions

### 4 Position Front Clamp

Slide the clamp to the end of the bow. Position the notched section of the saddle under the inner lip of the truck bed.

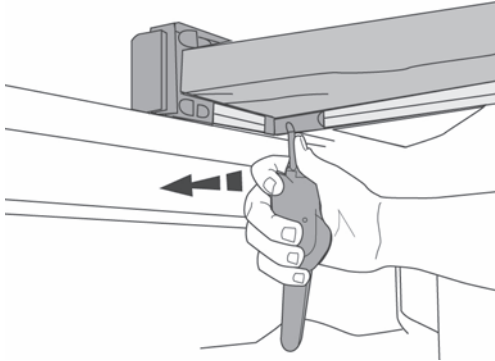

### 7 Secure Tonneau

Lower the tailgate and unfold the Tonneau to cover the bed.

Repeat Steps 3 – 5 to secure the rear clamps on both sides of the vehicle.



### 5 Secure Front Clamp

Pull the handle up to secure the clamp. Repeat Steps 3 – 5 on the passenger side.

**NOTE** Make sure clamps are secure before operating vehicle.



### 6 Unbuckle Retaining Straps

Unbuckle the retaining straps – one buckle per strap.



## EZ-Fold Tonneau Installation Instructions

### 8 Driving with the Tonneau Open Release Rear Clamps

Pull down on the handle to release the rear clamp on the driver's side.

Push down on the saddle to release it from the inner lip of the truck bed.

Slide clamp toward inside of bed.

Place clamp in horizontal storage position.

Repeat on the passenger side.

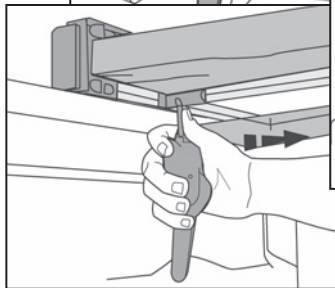
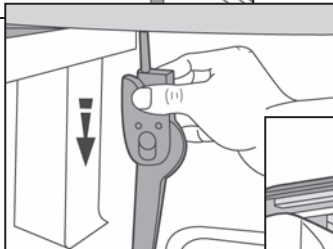

### 9 Driving with the Tonneau Open Fold Tonneau Forward

Fold the Tonneau toward the front of the vehicle.



### **!** WARNING

The buckle of each retaining strap and both clamps must be fastened securely to avoid damage to property or possible personal injury.

### 10 Driving with the Tonneau Open Secure Retaining Straps

Buckle one of the retaining straps to the front rail of the Tonneau.

Pull the end of the strap to tighten. Repeat with both retaining straps.

