





# Installation Instructions

## Replace-A-Door

### Vehicle Application

- Jeep Wrangler  
1988 – 1995  
Part Number: 53120

INSTALLATION TIME	SKILL LEVEL
 <b>1/4 Hour</b>	 <b>1 - Easy</b>

TOOLS
 Safety Glasses

Installation Tips
<b>Before you begin installing this assembly, read all instructions thoroughly.</b>
<b>For a smooth fit:</b> For ease in installation, the product should be installed at temperatures above 72° F. Below this temperature, the fabric may contract an inch or more, making it difficult to fit to the vehicle. It is normal for fabric to contract and wrinkle when stored in the shipping carton. Within a few days after installation, the fabric will relax and the wrinkles will disappear.

 **CAUTION** Safety glasses should be worn at all times while installing this product.

 **WARNING** This product is designed primarily to enhance the appearance of the vehicle and to shield the occupants from ordinary weather conditions. Do not rely in any way on the components of this product to contain occupants within the vehicle, or to protect against injury or death in the event of an accident. This product will not protect the occupants from falling objects. Never operate the vehicle in excess of manufacturer's specifications.

**WEAR SEAT BELTS AT ALL TIMES**

Read and follow, precisely, all installation instructions provided when installing product. Failure to do so may result in a poor fit and could place occupants of the vehicle in a potentially dangerous situation.

# Replace-A-Door – Installation Instructions

## 1 Remove Fabric Covers from Door Frames

Unfasten the plastic retainer at the bottom of the fabric door and remove it from the vehicle. Use a razor knife to cut the stitches on the old door covers and take them off of the door frames.

## 2 Install New Fabric Covers on Door Frames

Separate the hook and loop fasteners on the door covers and slide the new cover onto the frame, starting at the top. Work from corner to corner, wrapping the fabric around the frame and fastening the hook to the loop as you work around the door.

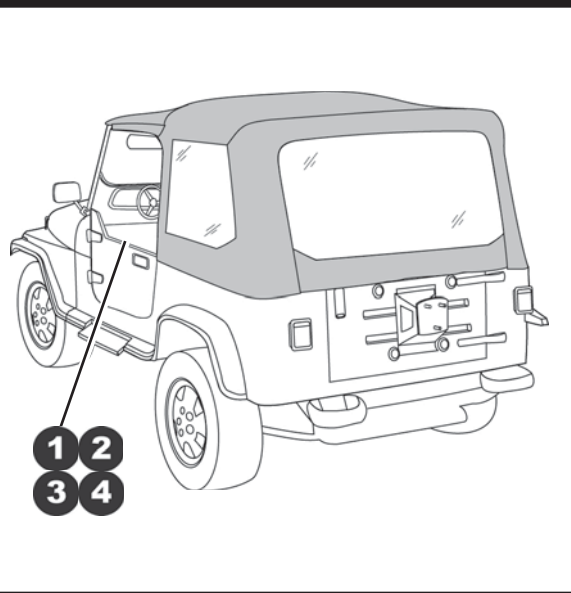
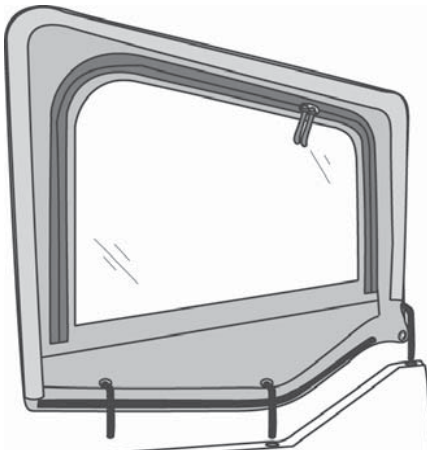

## 3 Reinstall Doors

Reinstall the upper doors. Insert the pins into the grommets in the lower door.

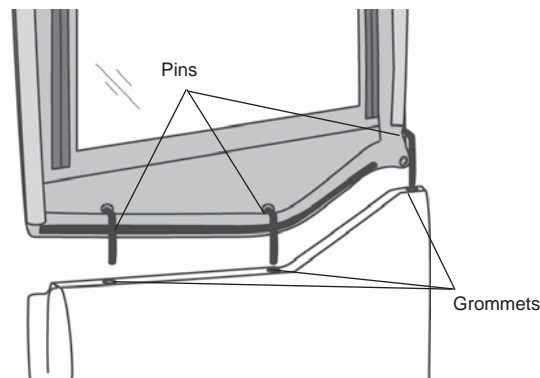

## 4 Secure Quarter Window

Fasten the snap at front of upper door. Slip plastic strip on the bottom of the soft door into the retainer on the steel door.

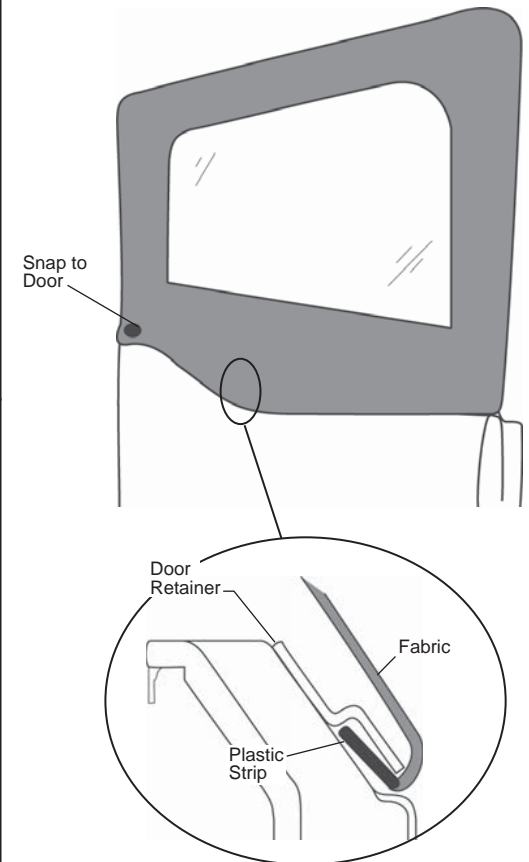

## Replace-A-Door – Installation Instructions

---

### Care and Maintenance of your Bestop Product

Your Bestop product is made of the finest materials available. To keep it looking new and for the maximum possible wear, it will need periodic cleaning and maintenance.

**Fabric:** The fabric should be washed often using soap, warm water and a soft bristle brush. Rinse with clear water to remove all traces of soap or use Bestop-recommended Bestop Cleaner and Bestop Protectant. Bestop Cleaner and Bestop Protectant are specially formulated to provide a total cleaning and protection system. Bestop Cleaner will not harm vehicle finish, is biodegradable and environmentally friendly. Bestop Protectant protects against UV-fading, cracking and hardening.

**Windows:** Keep windows clean to avoid scratching. DO NOT use a brush on the windows! Wash with a water-soaked cloth or sponge and a mild dishwashing detergent or use Bestop-recommended Bestop Vinyl Window Cleaner, which safely cleans and protects vinyl windows while helping prevent UV damage. NEVER WIPE THE WINDOWS WHEN THEY ARE DRY. Be careful when cleaning snow or frost from the vinyl windows since they are easily scratched and may crack at low temperatures. DO NOT roll the sides or rear window in cold weather. The windows become stiff and will crack. Cracks caused by misuse in cold temperatures are not covered under warranty.

**Zippers:** Keeping the zipper cleaned and lubricated with a silicone lubricant will help prevent damage and keep the zippers in a smooth working condition. If a zipper opens behind the slider, the slider may have been spread apart. This problem can usually be repaired by using an ordinary pair of pliers to bring the sides back into parallel. Return slider to the end of the zipper in the normal Open position. Squeeze lightly at first and test the zipper. If the zipper continues to remain open squeeze more firmly with the pliers and try the zipper again. Repeat this procedure until the zipper operates correctly.

**Water:** Seeping through at the seams may be stopped by applying 3-M Scotchgard® on the inside of the seams. Rips in the fabric may be repaired with Bondex® iron on patches. Iron the patches to the Inside of the top, carefully following the Bondex® instructions.

**Snaps:** Keep snaps cleaned and lubricated with silicone to help prevent snaps from sticking to the studs. If a snap does become stuck to a stud, use a screwdriver and GENTLY pry apart to prevent permanent damage to the snap or the top fabric.

