





Installation Instructions TJ Header Windshield Channel

Vehicle Application

- Jeep Wrangler TJ
1997 – 2006
Part Number: 51238

INSTALLATION TIME	SKILL LEVEL
 1/2 Hour	 1 - Easy

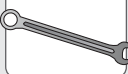
TOOLS	
 Safety Glasses	 Wrench 1/2"





Installation Tips

Before you begin installing this assembly, read all instructions thoroughly.

For a smooth fit:

For ease in installation, the product should be installed at temperatures above 72° F. Below this temperature, the fabric may contract an inch or more, making it difficult to fit to the vehicle. It is normal for fabric to contract and wrinkle when stored in the shipping carton. Within a few days after the installation, the fabric will relax and the wrinkles will disappear.

 **CAUTION** Safety glasses should be worn at all times while installing this product.

 **WARNING** This product is designed primarily to enhance the appearance of the vehicle and to shield the occupants from ordinary weather conditions. Do not rely in any way on the components of this product to contain occupants within the vehicle, or to protect against injury or death in the event of an accident. This product will not protect the occupants from falling objects. Never operate the vehicle in excess of manufacturer's specifications.

WEAR SEAT BELTS AT ALL TIMES

Read and follow, precisely, all installation instructions provided when installing product. Failure to do so may result in a poor fit and could place occupants of the vehicle in a potentially dangerous situation.

Parts List and Hardware Identification

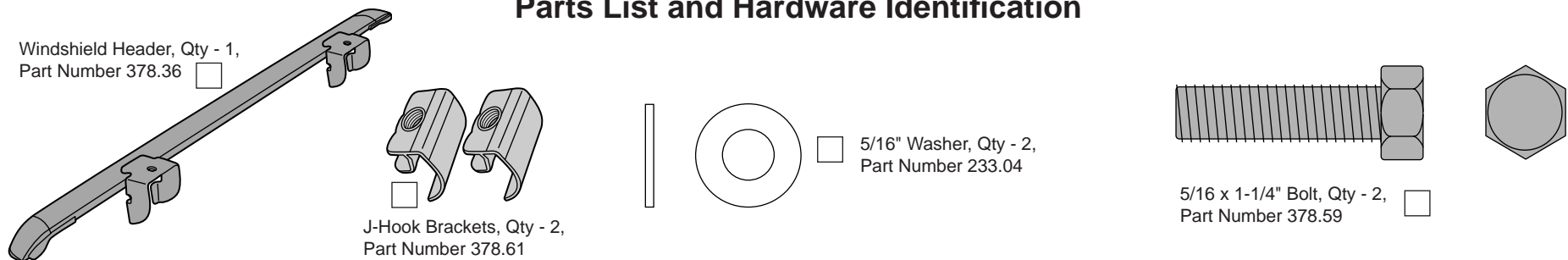

Installation

Step One

INSTALL WINDSHIELD RETAINER

Place the Windshield Retainer assembly on top of the bulb seal along the top of the Windshield.

Locate the two J-Hook Brackets in the parts kit. Orient a bracket with the hook toward the front and the threaded insert toward the top. Slide the bracket into one of the J-Hook Bracket Bases mounted to the Windshield Retainer and catch the hook in the slot in the windshield. Insert a 5/16 x 1-1/4" Bolt and a 5/16" Washer from the top of the base into the J-Hook Bracket to secure the bracket to the base. Repeat this on the other side of the vehicle.

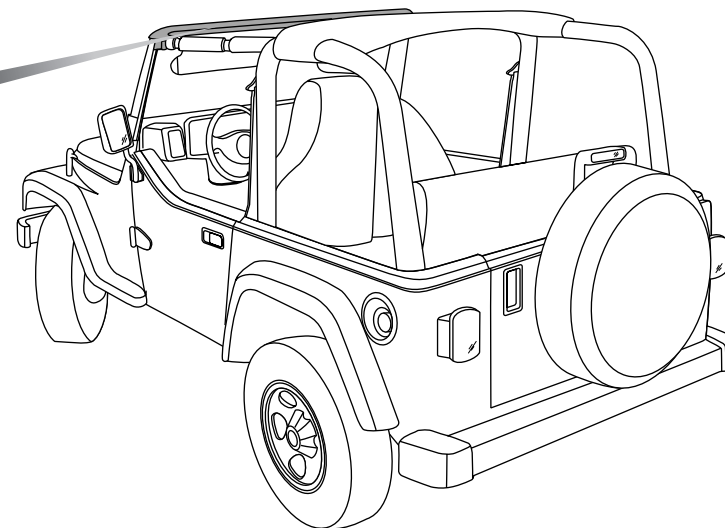
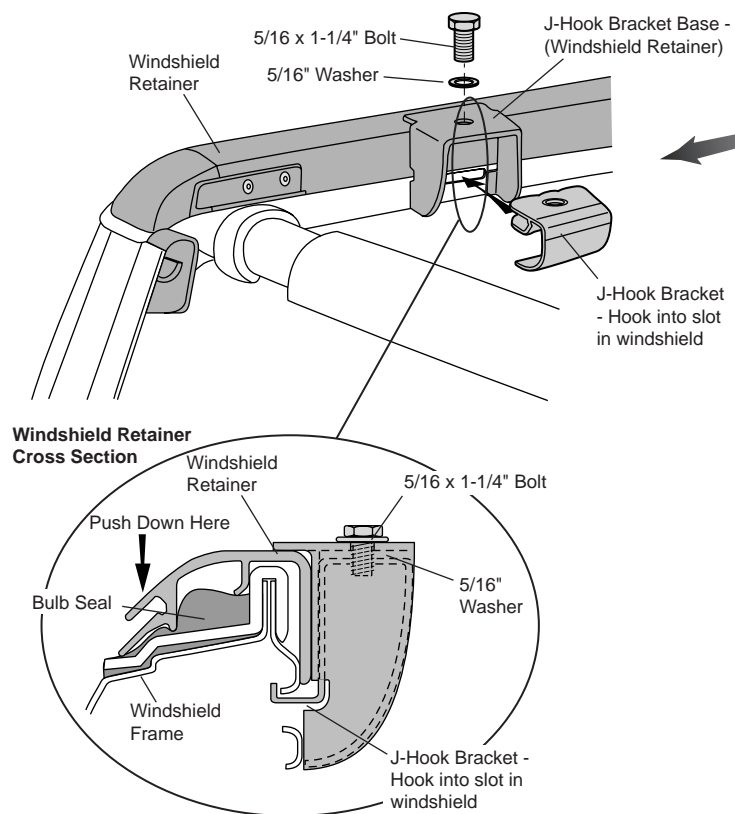

Note: While installing the Windshield Retainer/J-Hook Bracket Assembly, apply firm pressure toward the front of the vehicle to make sure that the assembly is installed correctly over the bulb seal.

