



# Installation Instructions Fabric Replacement Top

Vehicle Application:  
GEO Tracker, Suzuki Sidekick 1999-2004  
Part Number 51366

## Installation Tips

**Before you begin installing your new Replacement Top, please read all the instructions thoroughly.**

For easier installation, the top should be installed at a temperature above 72° F. Below this temperature, the fabric may contract making it difficult to fit the vehicle.



**WARNING** Do not rely in any way on the components of this product to protect against injury or death in the event of an accident. Never operate the vehicle in excess of manufacturer’s specifications.

Read and follow, precisely, all installation instructions provided when installing this product. Failure to do so may result in a poor fit and could place occupants of the vehicle in a potentially dangerous situation.



**CAUTION** Safety glasses should be worn at all times when installing this product.

**WEAR SEAT BELTS AT ALL TIMES**

Tools	Installation Time	Support
<div style="display: flex; justify-content: space-around; align-items: center;"> <div style="text-align: center;">             Safety Glasses         </div> <div style="text-align: center;">             3mm Hex Key         </div> </div>	<div style="text-align: center; margin-bottom: 10px;"> <div style="border: 2px solid black; padding: 5px; display: inline-block; font-weight: bold;">1 00</div>  <b>1 Hours</b> </div> <div style="text-align: center;"> <div style="background-color: #cccccc; padding: 5px; font-weight: bold;">Skill Level</div> <div style="display: flex; justify-content: center; gap: 10px; margin-top: 5px;"> <span style="border: 1px solid black; border-radius: 50%; padding: 5px;">1</span> <span style="border: 2px solid black; border-radius: 50%; padding: 5px; font-weight: bold;">2</span> <span style="border: 1px solid black; border-radius: 50%; padding: 5px;">3</span> <span style="border: 1px solid black; border-radius: 50%; padding: 5px;">4</span> </div> <p>2 - Moderatly Easy</p> </div>	<p style="text-align: center;">We're here to help! Go to <a href="http://www.Bestop.com">www.Bestop.com</a> and click on "Need Help?"</p>



# Installation Instructions Fabric Replacement Top

Vehicle Application:  
GEO Tracker, Suzuki Sidekick 1999-2004  
Part Number 51366

## Sugerencias de Instalación

**Antes de empezar a instalar esta unidad, lea atentamente todas las instrucciones.**

### Para un buen ajuste:

Para facilitar la instalación, el producto debe instalarse a temperaturas superiores a 72 °F (22 °C).

Por debajo de esta temperatura, la tela puede encogerse una pulgada o más, lo que dificultaría su ajuste al vehículo.

Es normal que la tela se contraiga o arrugue cuando está guardada en la caja de empaque. A los pocos días después de la instalación, la tela se relajará y las arrugas desaparecerán.



### ADVERTENCIA

Este producto se diseñó principalmente para mejorar la apariencia del vehículo y proteger a los ocupantes de las condiciones climáticas comunes. De ninguna manera piense que los componentes de este producto pueden servir como medio de contención para los ocupantes del vehículo o que pueden protegerlos contra lesiones o la muerte en caso de accidente. Este producto no protegerá a los ocupantes contra caídas de objetos. Nunca conduzca este vehículo fuera de las especificaciones del fabricante.

### USE LOS CINTURONES DE SEGURIDAD EN TODO MOMENTO

Lea y siga con precisión todas las instrucciones de instalación que se proporcionan para instalar este producto. Si no lo hace, podría producirse un mal ajuste que colocaría a los ocupantes del vehículo en una situación potencialmente peligrosa.



### PRECAUCIÓN

Debe usar gafas protectoras en todo momento durante la instalación de este producto.

## Conseils pour l'installation

**Lire toutes les instructions au complet avant de commencer l'installation de cet assemblage.**

### Pour un ajustement sans problème :

Afin de faciliter l'installation, ce produit doit être installé à des températures au-dessus de 72 °F (22 °C).

Sous cette température, le tissu peut rétrécir d'un pouce (2,5 cm) ou plus, ce qui rendra l'ajustement sur le véhicule difficile.

Il est normal que le tissu rétrécisse et plisse pendant qu'il est dans la boîte d'expédition. En quelques jours après l'installation, le tissu se détendra et les plis disparaîtront.



### AVERTISSEMENT

Ce produit est conçu principalement pour améliorer l'apparence du véhicule et pour protéger les occupants des conditions météorologiques usuelles. Ne jamais se fier aux composants de ce produit pour se protéger de blessures ou de la mort en cas d'accident. Ce produit ne protégera pas les occupants des chutes d'objets. Ne jamais utiliser le véhicule au-delà des caractéristiques techniques indiquées par le fabricant.

### PORTER UNE CEINTURE DE SÉCURITÉ EN TOUT TEMPS

Lire et suivre, très fidèlement, toutes les instructions d'installation fournies lors de l'installation de ce produit. Ne pas suivre cette consigne peut causer une installation inadéquate et mettre les occupants du véhicule dans une situation potentiellement dangereuse.



### MISE EN GARDE

Des lunettes de sécurité doivent être portées en tout temps lors de l'installation de ce produit.

Parts List	
Front Deck	Qty - 1
Rear Deck	Qty - 1
Quarter Window, Rt.	Qty - 1
Quarter Window, Lt.	Qty - 1
Rear Window	Qty - 1

	<b>Caution</b>	Safety glasses should be worn at all times while installing this product.
---	----------------	---

## Top Installation

### Step One

Remove the old top. Set aside the two 7/64 Allen Bolts in the front center pillar retainer aside to be used in installing the Replacement Top (see Step Three) and the Rear Window Retainer Bar (see Step Eleven).

### Step Two

Orient the Front Deck with the snaps toward the front of the vehicle and the vinyl side up. Turn the deck over and lay it vinyl side down on the center pillar of the vehicle with the plastic retainer strip toward the front. Locate the center notch in the strip and align it with the arrow marking the center of the retainer along the front edge of the center pillar. Slip the plastic strip into the channel on the retainer.

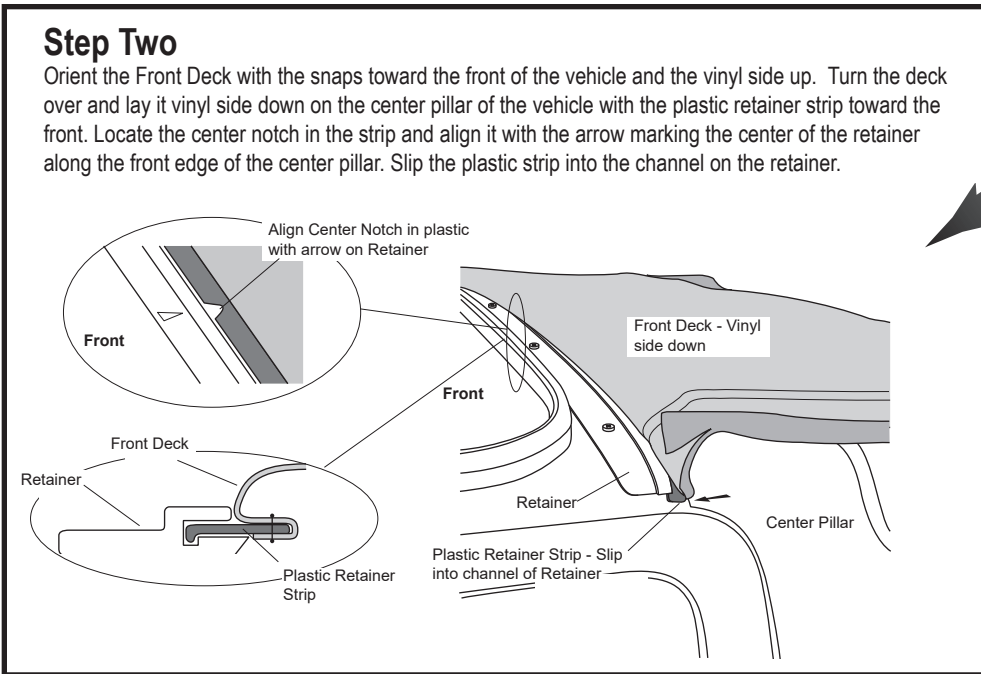
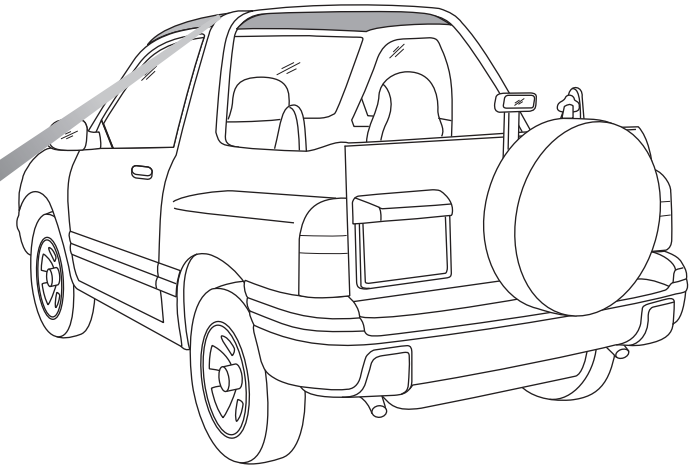

### Step Three

Reinstall the 3mm Allen Bolt in the slot on each end of the Retainer on the center pillar.

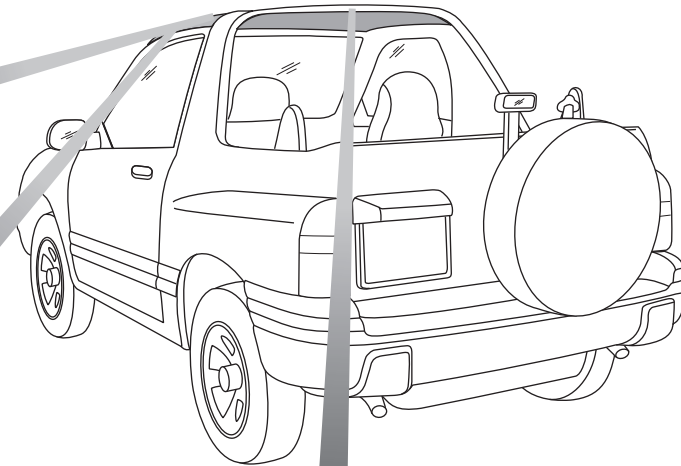
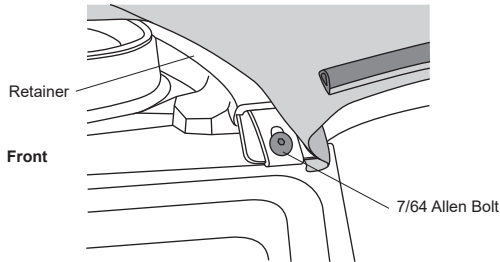

### Step Four

Raise the Windshield Header Assembly and slip the front of the Front Deck over the front edge of the header, working the pockets in the top over the corners of the header. Snap the seven snaps on the top to the snaps on the header. The snaps on the header slide to align with the snaps on the top.

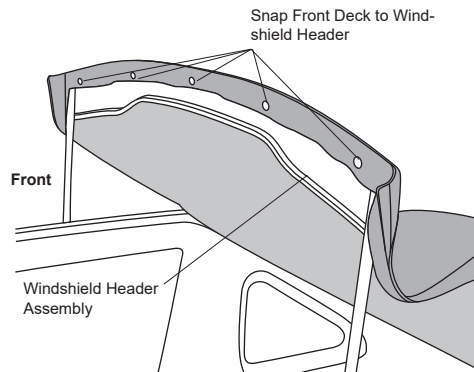

### Step Five

Locate the flap with two tabs sewn inside the rear of the Front Deck. Snap the tabs on each side of the Dome Light.

The web strap sewn to the flap is used to tie the fabric out of the way when the Header is open. To use the strap, slip the end of the strap through the slot in the header and fasten the loop sewn to the end of the strap to the hook on the strap.

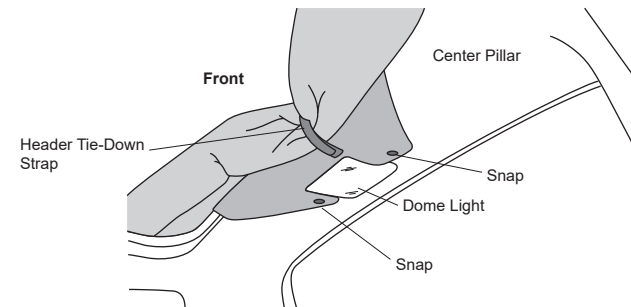

### Step Six

Close the header to the windshield. Hook the latches to the header and close them to secure the front of the deck to the windshield.

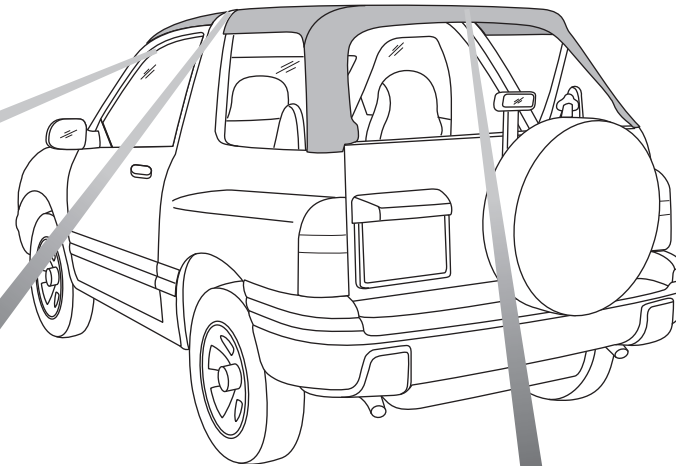
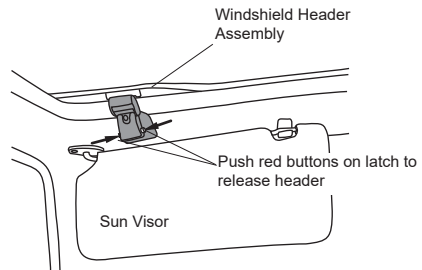

### Step Seven

Orient the Rear Deck with the plastic strip toward the front of the vehicle and the vinyl side up. Align the notch in the center of the plastic strip with the arrow that marks the center of the retainer along the rear of the center pillar. Slip the plastic strip into the channel on the retainer.

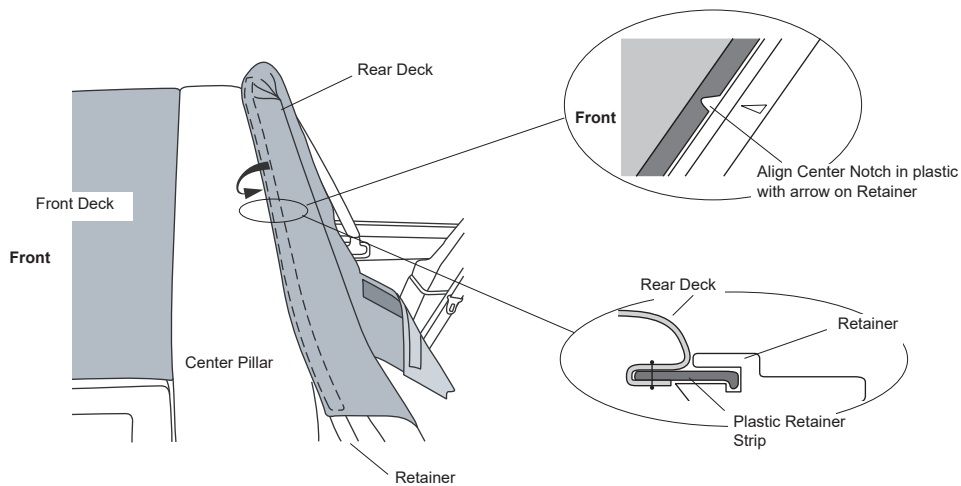

### Step Eight

Raise the rear bow and slip it into the rear corners of the Rear Deck. Wrap the snap tabs sewn into the top above the rear window opening around the bow and snap them to the bow.

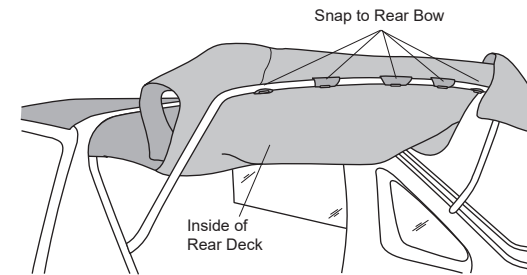

## To Release the Bow Assembly

To release the bow assembly, push the button on the bow release and pull the latch away from the bow.

To lock the bows into the upright position, close the latch against the bow until it locks into place.

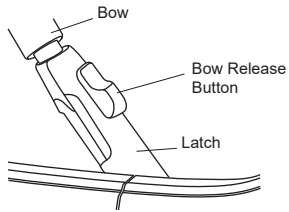

**Bow in Upright Position**

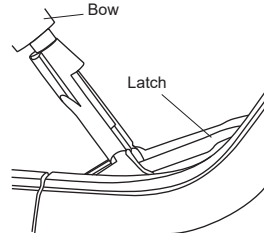

**Bow in Released Position**

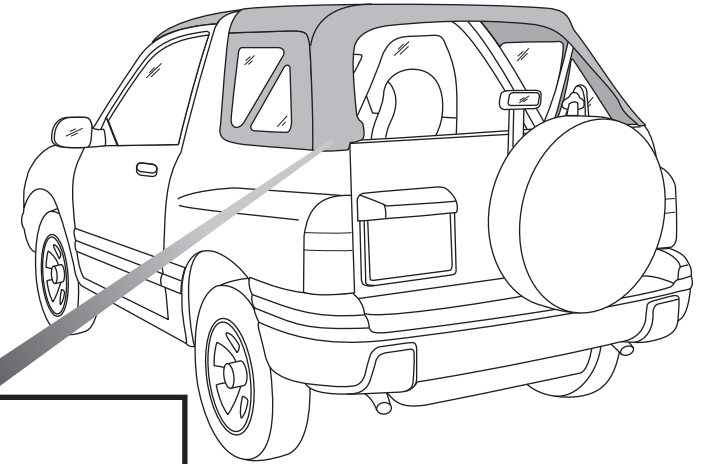

## Step Nine

Make sure that the rear bow assembly is released and that the bow is in the released position.

Pull the rear legs of the deck down to the rear corners of the vehicle and locate the plastic strip sewn to the bottom of each leg. Slip the plastic into the corner retainer on the vehicle. The rear edge of the plastic should butt up against the stop on the retainer next to the tailgate opening and the front edge of the plastic should rest next to a pin in the retainer. If your vehicle does not have a pin in the retainer next to the front edge of the plastic strip, hook the plastic clip in the top over the edge of the retainer above the tailgate opening.

Lock the bows into the upright position.

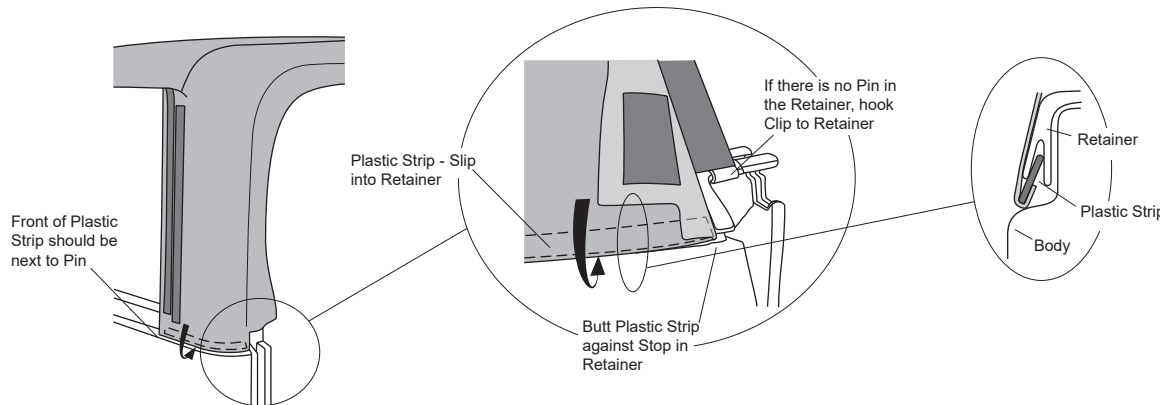

### Step Ten

Orient the Quarter Windows with the zipper toward the top and rear of the panel. Start the zipper at the top front corner and close it a few inches. Slip the plastic strip along the front and bottom of the panel into the retainer on the vehicle. Close the zipper to the rear corner of the panel. Make sure that the panel is seated into the retainer for a smooth fit. Tuck the top edge of the panel under the deck and fasten the hook and loop strips along the top and rear of the panel.

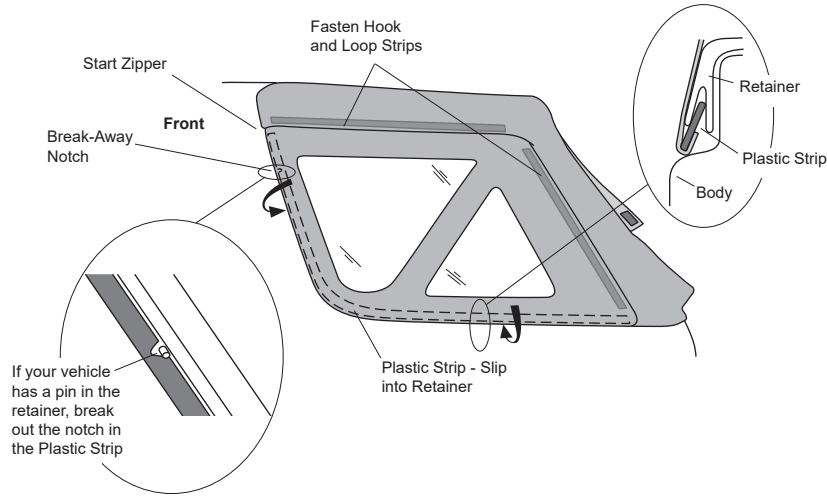

**Note:** The plastic strip along the front of the Quarter Window has a break-away notch. If your vehicle has a pin in the retainer that keeps the retainer from rolling into the channel, break out the notch and center it over the pin when setting the plastic strip into the retainer.

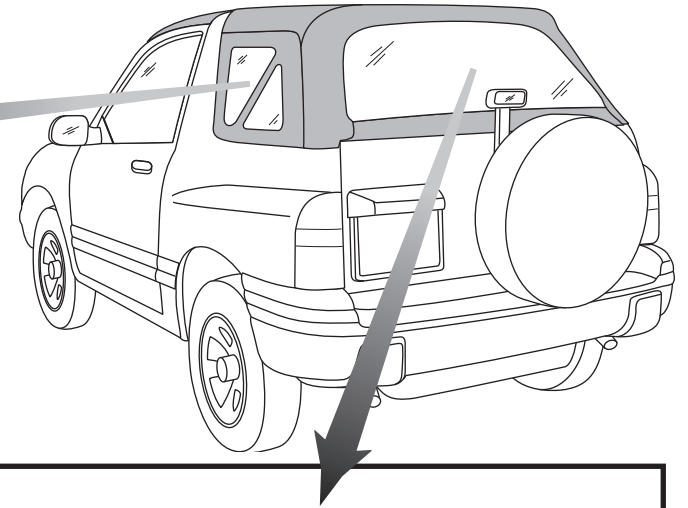

### Step Eleven

Open the tailgate and orient the Rear Window with the zipper toward the top and the vinyl side out. Start the zipper on the passenger side of the vehicle and close it halfway to the other side. Slide the round channel in the Rear Window Retainer Bar onto the bottom edge of the window. Press the bar onto the ledge of the Rear Corner Retainers on each side of the tailgate opening. Close the zipper. Locate the loop flaps sewn on each side of the Rear Window, fold them over the ends of the zipper and fasten them to the hook sewn inside the top. Close the tailgate.

#### Detail of Rear Window Retainer Bar

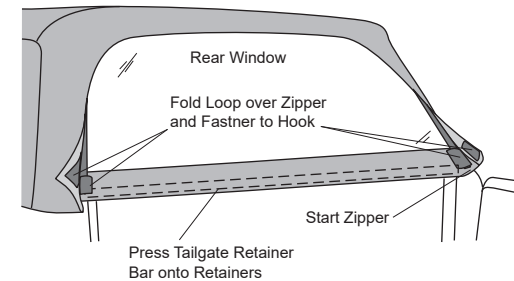
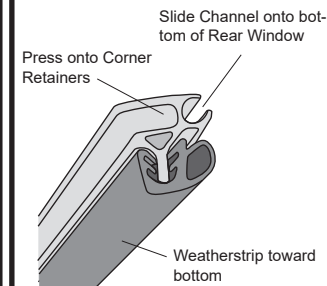

## Care and Maintenance of your Bestop Top

Your top is made of the finest materials available. To keep it looking new and for the maximum possible wear, it will need periodic cleaning and maintenance.

**Washing:** The top fabric should be washed often using soap, warm water and a soft bristle brush. Rinse with clear water to remove all traces of soap.

**Windows:** Keep windows clean to avoid scratching. **DO NOT** use a brush on the windows! Wash with a watersoaked cloth or sponge and a mild dishwashing detergent. **NEVER WIPE THE WINDOWS WHEN THEY ARE DRY.** Be careful when cleaning snow or frost from the vinyl windows since they are easily scratched and may crack at low temperatures. **DO NOT** roll the sides or rear window in cold weather. The windows become stiff and will crack.

**Zippers:** Keeping the zipper cleaned and lubricated with a silicone lubricant will help prevent damage and keep the zippers in a smooth working condition. If a zipper opens behind the slider, the slider may have been spread apart. This problem can usually be repaired by using an ordinary pair of pliers to bring the sides back into parallel. Return slider to the end of the zipper in the normal Open position. Squeeze lightly at first and test the zipper. If the zipper continues to remain open squeeze more firmly with the pliers and try the zipper again. Repeat this procedure until the zipper operates correctly.

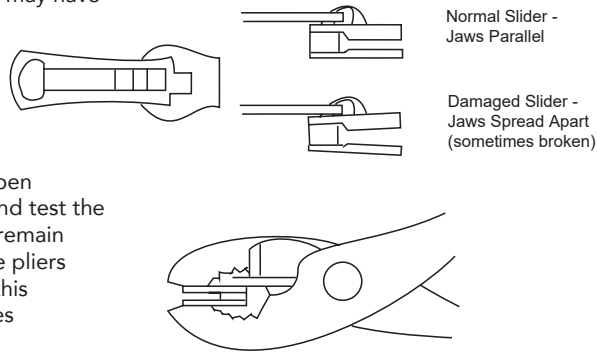

**Water:** Seeping through at the seams may be stopped by applying 3-M Scotchgard® on the inside of the seams. Rips in the fabric may be repaired with Bondex® iron on patches. Iron the patches to the Inside of the top, carefully following the Bondex® instructions.

**Snaps:** Keep snaps cleaned and lubricated with silicone to help prevent snaps from sticking to the studs. If a snap does become stuck to a stud, use a screwdriver and GENTLY pry apart to prevent permanent damage to the snap or the top fabric.





# Installation Instructions Fabric Replacement Top

Vehicle Application:  
GEO Tracker, Suzuki Sidekick 1999-2004  
Part Number 51366

## WHAT BESTOP WARRANTS

Subject to the terms and conditions of sale, including any terms and conditions set forth by Bestop, Inc. ("Bestop" or "us" or "we") in our then-current terms of sale on our website (collectively, the "Terms"), Bestop represents and warrants that: the covered products listed in the "Covered Products and Warranty Periods" section (a "Product") will substantially be free from defects in materials and workmanship for the specified warranty periods set forth in that section.

## THE WARRANTY IS LIMITED AND CONDITIONAL

This warranty applies to the original purchaser of the Product only. The warranty is valid only as long as the original retail purchaser owns the vehicle upon which the Product is installed. The warranty expires should the Product be removed from the original vehicle or if the original vehicle is transferred to another owner.

This warranty is not transferable or assignable. The warranty does not apply to Product bought from auction-style or price-bid websites.

THE LIMITED WARRANTY AND STATED REMEDIES ARE SOLE AND EXCLUSIVE AND IN LIEU OF ALL OTHER WARRANTIES AND REMEDIES, AND COMPANY EXPRESSLY DISCLAIMS ALL IMPLIED OR STATUTORY OR OTHER WARRANTIES, INCLUDING WITHOUT LIMITATIONS WARRANTIES OF MERCHANTABILITY, NON-INFRINGEMENT OR FITNESS FOR A PARTICULAR PURPOSE. IN NO EVENT WILL COMPANY BE LIABLE FOR ANY SPECIAL, INCIDENTAL, CONSEQUENTIAL, PUNITIVE, INDIRECT OR EXEMPLARY DAMAGES OF ANY KIND, INCLUDING LOST PROFITS OR REVENUE, HOWEVER CAUSED, WHETHER FOR BREACH OR REPUDIATION OF CONTRACT, TORT, BREACH OF WARRANTY, NEGLIGENCE, OR OTHERWISE, WHETHER OR NOT COMPANY WAS ADVISED OF THE POSSIBILITY OF SUCH LOSS OR DAMAGES.

*Some states do not allow exclusion or limitation, so this may not apply to you. This warranty gives you specific legal rights, and you may have other rights which vary from state to state.*

## EXCLUSIONS TO THE WARRANTY

The Limited Warranty excludes, and Bestop is not liable in any way for any warranty claims, damages, or defects related to:

- Misuse, abuse, accidents, vandalism, negligence, fire, or improper installation or modification, or improper or inadequate maintenance;
- Failure to comply with any Product documentation, Bestop instructions, or applicable law or regulations; use in extreme conditions
- Force Majeure including but not limited to, earthquake, hurricane, tornado, flooding, or other disasters natural or man-made, civil unrest, strikes, declared or undeclared war, or lack of performance by, or discontinued product of, supply chain partners whose products, software, operations or management is beyond the control of Bestop;
- Damage resulting in breakage (including without limitation, spontaneous breakage, accidental breakage or breakage by any other means) of a Product or any component part;
- Damage to vinyl windows due to misuse, or cracking due to varying weather conditions.

## YOUR SOLE REMEDY

During the applicable warranty period, Bestop shall, at its option, either repair or replace any Product that it confirms, in its discretion, is non-compliant with the warranties herein. Bestop will not pay for labor charges associated with installation or removal of the Product. Should a specific Product be discontinued, Bestop may, at its option, replace the discontinued Product with a current product or like product.

Please retain your proof of purchase. Original proof of purchase for the Product must accompany any warranty claim. If you have a warranty claim, first you must email Bestop Customer Service at [csbestop@bestop.com](mailto:csbestop@bestop.com) for instructions. All claims must be emailed to [csbestop@bestop.com](mailto:csbestop@bestop.com) within 30 days of discovery of a defective Product, but in no event later than thirty days after the end of the applicable Warranty Period (the "Warranty Notice Period"). Warranty claims made after the Warranty Notice Period are null and void and Bestop shall have no responsibility with respect to such claims.

THIS SECTION SETS FORTH BESTOP'S SOLE OBLIGATION & YOUR SOLE REMEDY WITH RESPECT TO ANY DEFECTS OR OTHER PRODUCT ISSUE. ANY PRODUCTS REPLACED UNDER TERMS OF THIS WARRANTY WILL BE COVERED UNDER TERMS & BALANCE OF THE DURATION OF THE ORIGINAL LIMITED WARRANTY FOR SUCH PRODUCT.



# Installation Instructions Fabric Replacement Top

Vehicle Application:  
GEO Tracker, Suzuki Sidekick 1999-2004  
Part Number 51366

**COVERED PRODUCTS AND WARRANTY PERIODS:** The warranty time periods are as follows for Products manufactured by Bestop:

## **BESTOP® LIMITED LIFETIME WARRANTY**

Trektop® Pro Twill Fabric Top Sunrider® for Hardtop Twill Fabric Top  
Trektop® NX Glide Twill Fabric Top Replace-a-Top™ Twill Fabric Top  
Trektop® NX Twill Fabric Top Supertop® NX Twill Fabric Top  
EZFold™ Soft Tonneaus Floor & Cargo Liners  
ZipRail™ Soft Tonneaus Pet Barriers  
EZRoll™ Soft Tonneaus

## **BESTOP® 5-YEAR LIMITED WARRANTY**

Trektop® NX Glide™ Top (non-Twill) Sunrider® for Hardtop (non-Twill) Replace-a-Top™ Top (non-Twill) Trektop® NX Top (non-Twill)  
Sailcloth Replace-a-Top™ Supertop® NX Top (non-Twill)  
Tigertop™ and Halftop™ Supertop® Classic Soft Top Sunrider® Complete Soft Top Supertop® for Truck  
EZ Fold Hard Tonneau

## **BESTOP® 3-YEAR/100K MILES LIMITED WARRANTY**

Powerboard® & Powerboard® NX  
Trekstep®, Side Mount  
Trekstep®, Rear Mount

## **BESTOP® 3-YEAR LIMITED WARRANTY**

Pavement Ends Sprint Top

## **BESTOP® 2-YEAR LIMITED WARRANTY**

Trektop® Classic Soft Top  
RoughRider™ Soft Storage

## **BESTOP® 1-YEAR LIMITED WARRANTY**

All other Bestop® & Pavement Ends™ products not specified above.

**For further information or request for warranty work, please contact:**

**Bestop Inc. Customer Service**

**Toll-Free: (800)845-3567**

**E-mail: [csbestop@Bestop.com](mailto:csbestop@Bestop.com)**

**Website: [www.Bestop.com](http://www.Bestop.com)**