





Installation Instructions



Quick Release Bow Knuckles

Vehicle Application:

- Jeep TJ Wrangler/JK Wrangler and TJ Wrangler Unlimited
1997 – Current
JK Wrangler Unlimited 2007-2012
Does not fit JK Wrangler Unlimited w/ Lift Assist (2013- Current)
Part Number: 51289-51290

www.Bestop.com - We're here to help! Visit our web site and click on ["Ask a Question"](#). Click here for more [Jeep® Accessories by Bestop](#).

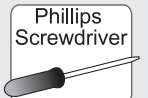
INSTALLATION TIME	SKILL LEVEL
 1/4 Hour	 1 - Easy

TOOLS		
 Torx Wrench T30	 Phillips Screwdriver	 Safety Glasses



⚠ WARNING This product is designed primarily to enhance the appearance of the vehicle. Do not rely in any way on the components of this product to protect against injury or death in the event of an accident. Never operate the vehicle in excess of manufacturer's specifications.

WEAR SEAT BELTS AT ALL TIMES

Read and follow, precisely, all installation instructions provided when installing product. Failure to do so may result in a poor fit and could place occupants of the vehicle in a potentially dangerous situation.

Quick Release Bow Knuckle Installation Instructions

Parts List and Hardware Identification

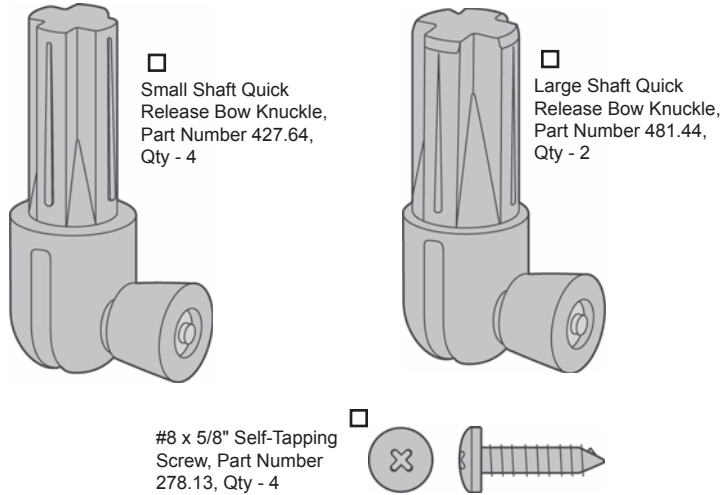

2 Remove Existing Bow Knuckles

Use a T30 Torx wrench to remove the bows from the bow mount brackets. Then use a phillips screwdriver to remove the screws that secure the existing bow knuckles in the ends of the bows.

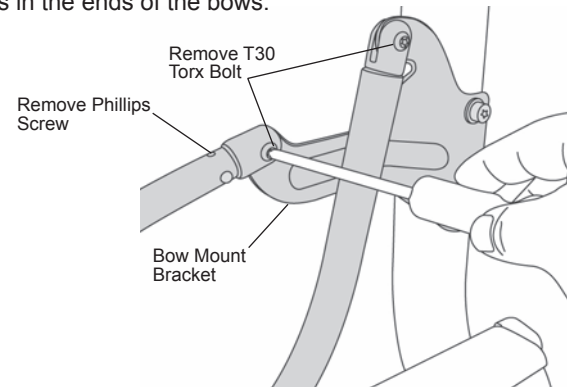

1 Lower Soft Top

Release the bows and lay the soft top down on the rear of the vehicle.

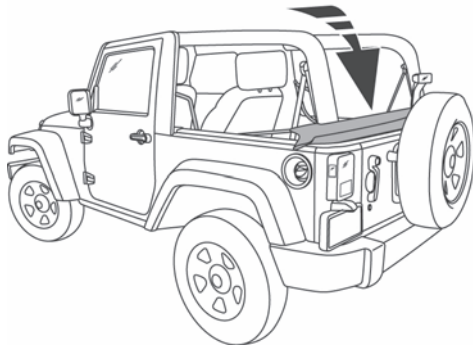

3 Install Quick Release Bow Knuckles

For 4 door vehicles: Slide a Small Shaft Quick Release Bow Knuckle into the end of each bow. The Large Shaft Quick Release Bow Knuckles will not be used.

For 2 door vehicles: Slide a Small Shaft Quick Release Bow Knuckle into the end of the small diameter inside bows. Slide a Large Shaft Quick Release Bow Knuckle into the end of the large diameter outside bow. The remaining Small Shaft Quick Release Bow Knuckles will not be used.

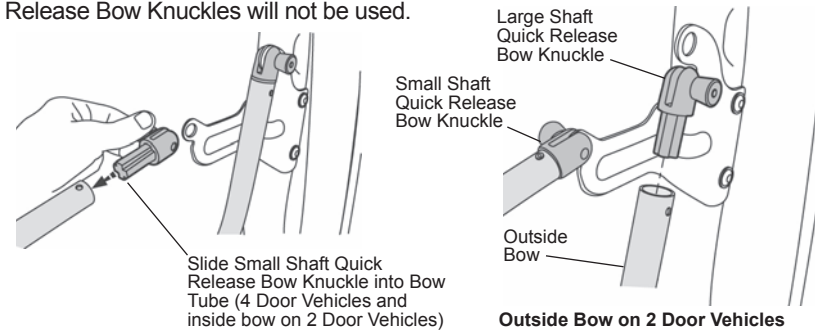

Quick Release Bow Knuckle Installation Instructions



CAUTION

Failure to orient the Quick Release Bow Knuckle properly could result in damage to the bow system.

4 Orient Quick Release Bow Knuckle

Rotate the Quick Release Bow Knuckle into the position for your vehicle.

For 4 door vehicles: The spring handles are toward the inside of the vehicle for both bows.

For 2 door vehicles: The spring handle on the outside bow is toward the outside of the vehicle and the spring handle for the inside bow is toward the inside of the vehicle.

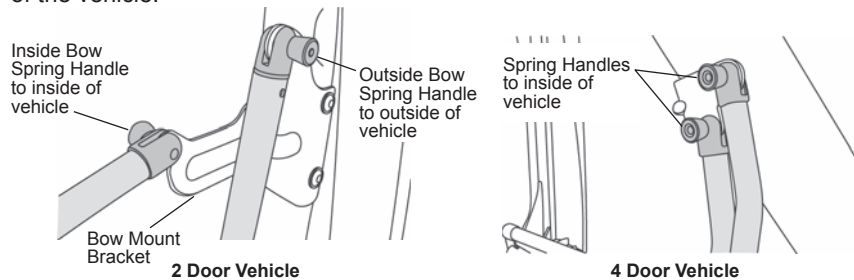

6 Secure Quick Release Bow Knuckle to Bow

With the Quick Release Bow Knuckle secured to the bow mount bracket, check the alignment of the bow and make sure that the Quick Release Bow Knuckle and Adapter Sleeve are inserted completely into the bow tube. Use the holes in the bow as a guide to install #8 x 5/8" Self-Tapping Screws to secure the Quick Release Bow Knuckle to the bow. Do not over tighten the Self-Tapping Screws.

Repeat this procedure for the other Quick Release Bow Knuckles.

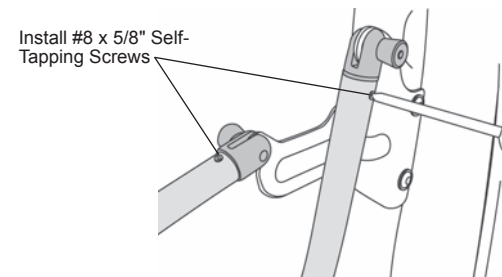

5 Secure Quick Release Bow Knuckle to Bow Mount Bracket

Pull out on the spring handle on the Quick Release Bow Knuckle and slide the slot in the knuckle over the bow mount bracket. When the spring pin lines up with the hole in the bracket release the handle so that the pin catches in the hole.

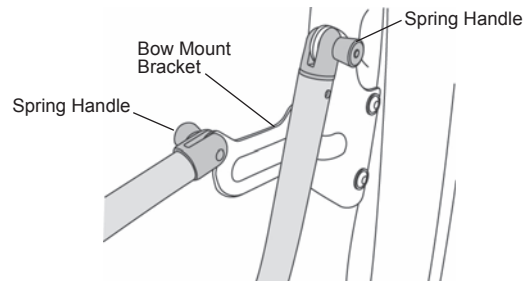

Quick Release Bow Knuckle Installation Instructions

LIMITED WARRANTY

We warrant our product to be free from defects in material and workmanship, for the terms specified below, provided there has been normal use and proper maintenance. This warranty applies to the original purchaser only. All remedies under this warranty are limited to the repair or replacement of any item or items found by the factory to be defective within the time period specified. If you have a warranty claim, first you must call our factory at the number below for instructions. You must retain proof of purchase and submit a copy with any items returned for warranty work. Upon completion of warranty work, if any, we will return the repaired or replaced item or items to you freight prepaid. Damage to our products caused by accidents, fire, vandalism, negligence, misinstallation, misuse, Acts of God, or by defective parts not manufactured by us, is not covered under this warranty.

THE WARRANTY TIME PERIOD IS AS FOLLOWS FOR REPLACE-A-TOP™, SAILCLOTH REPLACE-A-TOP™, SUPERTOP®, SUPERTOP® REPLACEMENT SKINS, SUNRIDER®, AND TIGERTOP®: TWO YEARS FROM DATE OF PURCHASE.

THE WARRANTY TIME PERIOD IS AS FOLLOWS FOR ALL OTHER "SOFT GOODS" MANUFACTURED BY OUR COMPANY (USING PRIMARILY VINYL, PLASTICS, AND/OR FOAM): ONE YEAR FROM DATE OF PURCHASE.

THE WARRANTY TIME PERIOD IS AS FOLLOWS FOR ALL OTHER "HARD GOODS" MANUFACTURED BY OUR COMPANY (USING PRIMARILY METALS, PLASTICS, AND/OR FIBERGLASS): ONE YEAR FROM DATE OF PURCHASE.

ANY IMPLIED WARRANTIES OF MERCHANTABILITY AND/OR FITNESS FOR A PARTICULAR PURPOSE CREATED HEREBY ARE LIMITED IN DURATION TO THE SAME DURATION AND SCOPE AS THE EXPRESS WRITTEN WARRANTY. OUR COMPANY SHALL NOT BE LIABLE FOR ANY INCIDENTAL OR CONSEQUENTIAL DAMAGE.

Some states do not allow limitations on how long an implied warranty lasts, or the exclusion or limitation of incidental or consequential damages, so the above limitations or exclusions may not apply to you. This warranty gives you specific legal rights, and you may also have other rights which vary from state to state.

